

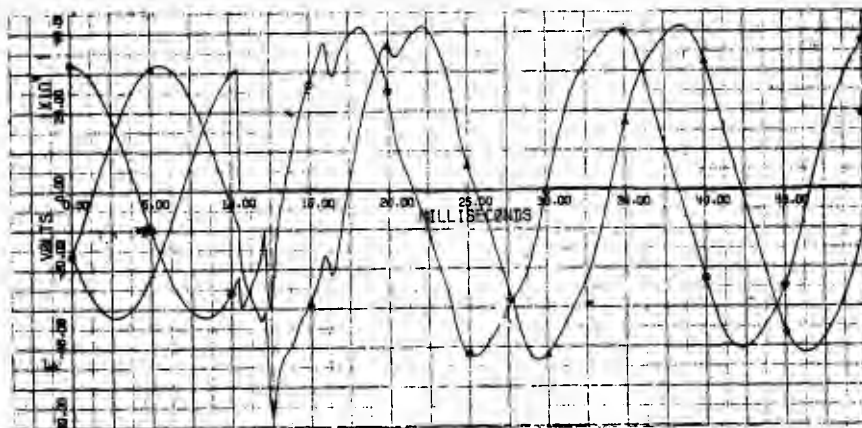

ELECTROMAGNETIC TRANSIENTS PROGRAM (EMTP)

Rule Book



Methods Development Branch, Route EOGB
Division of System Engineering
Bonneville Power Administration
P. O. Box 3621
Portland, Oregon 97208
Phone: (503) 230 - 4404, or 4402

Revision date (last entry): Jan 73, Jul 74,
Jan 76, Nov 77, May 80, Sep 80,
Apr 82, Mar 83, Jun 84



TABLE OF CONTENTS

	Page ----
0. General Introductory Information about the EMTP	iv
0.1 Availability of program to others	iv
0.2 Program maintenance and development	iv-a4
0.3 Program capability (summary)	v
0.4 Supporting reference material	vi
0.5 EMTP availability on different computer systems	viii
0.6 User-controlled variable dimensioning of EMTP	xiii
0.7 FORTRAN data format specifications	xviii
1. Structure of EMTP input data	1
1.0 Cards to begin a new data case (including misc. data cards) . . .	3c
1.1 Specially-requested extensions to misc. data cards	5
1.2 Branch cards for linear branches	
1.20 TACS data cards (if any)	5e
1.21 Branch card for lumped series R, L, C	6
1.22 Branch input using "CASCADED PI" feature	7
1.23 Branch cards for Pi-Equivalents	8
1.24 Branch cards for mutually-coupled R-L elemnts	12
1.25 Saturable transformer components	12d
1.26 Branch cards for distributed-parameter transmission lines . .	13
1.26a Special double-circuit distributed line	15b
1.26b Frequency dependence for distributed lines	15g
1.26b1 Marti modeling (recursive)	15g
1.27 Recursive convolution modeling of frequency- dependent transmission circuits	16c-1
1.28 Branch cards for pseudo-nonlinear resistance (type-99 branch)	16d
1.29 Branch cards for pseudo-nonlinear reactor (type-98 branch)	16g
1.30 Branch cards for staircase R(t) (type-97 branch)	16j
1.31 Branch cards for pseudo-nonlinear hysteretic reactor (type-96 branch)	16l
1.32 Branch cards for multi-phase ZnO surge arresters	17
1.3 Comments about branch cards for nonlinear and time-varying branches	18
1.35 Multiphase time-varying linear resistance	19
1.36 Multiphase piecewise linear resistance with flashover . . .	21
1.37 Branch card for nonlinear inductance	24
1.4 Switch cards (switches in general)	26
1.40 Ordinary switches	26a
1.43 TACS-controlled switch type-11 for diode and valve application	30c
1.44 TACS-controlled switch type-12 for speak gap and triac application	30f
1.45 TACS-controlled ordinary switch without restrictions on opening current	30h

1.6	Source cards	31
1.61	Controlled d-c voltage source	34a
1.62	3-phase dynamic synchronous machine source component (Park's equations)	34d
1.63	Universal machine (U.M.) dynamic source component	36f
1.66	Data cards for EMTP load flow ("FIX SOURCE" usage)	36s
1.7	Cards for overriding initial conditions	37
1.8	Output specification cards	38
1.8a	Conventional data cases	38
1.8b	"STATISTICS" and "SYSTEMATIC"	38c
1.9	User specification of osource function (type 1-10)	39
1.10	Cards for batch-mode plotting	40
2.	Description of EMTP output	44
2.1	Input data listing and interpretation	44
2.2	Format of printed, computed results	46
2.2a	Printed transients solution variables	46
2.2b	Non-fatal informative messages	46a-1
2.2c	Connection discontinuities during solution	49
2.2d	Storage and running time statistics	49a-1
2.3	Annotated computer results for simple test problem	49a-1
2.4	Error message terminations	50
4.	Formulas	82
4.1	Transformation used for multiphase lines	82
4.2	Lumped series resistance in line	85
5.	Interactive CRT plotting of EMTP solutions	86
6.	Transformer representation	87
6.1	Simplified model	87
6.2	More detailed model for single-phase units	89
7.	Auxiliary supporting routines	93a
7.0	"JMARTI SETUP" routine	93a-1
7.1	Transformer impedance-matrix program	93b
7.2	Magnetic saturation program CONVERT	101
7.2A	"HYSDAT" routine	103b
7.2B	"ARRDAT" routine	103h
7.4	"LINE CONSTANTS" routine	113
7.5	"SEMLYEN SETUP" routine	201
7.7	"CABLE CONSTANTS" routine	251
8.	TACS --- a digitally-simulated analog computer	274
8.1	Purpose of TACS	279
8.2	Summary of TACS capability	280
8.3	How to simulate what	280
8.4	TACS steady-state initialization rules	284
8.5	TACS elements and card formats	286
8.5.1	Transfer functions or S-blocks	286

8.5.3	Limiters	289
8.5.4	Signal sources	292
8.5.5	Supplemental variables and devices	295
8.5.6	TACS output-variable specification	312
8.5.7	TACS user-defined initial conditions	313
9.	Interactivity (SPY) ----- To be completed (later)		???
10.	Index (alphabetically-ordered references)	331

0. GENERAL INTRODUCTORY INFORMATION ABOUT THE PROGRAM

Let this manual begin with a disclaimer as to what it is not! The current name "Rule Book" is a replacement for the older term "User's Manual" which was employed for editions dated November 1977 and earlier. The name change was for good reason: there is a bare minimum of user instruction in the manual. So, novice users, do not expect to read this manual as a tutorial handbook. That, it is not! Instead, it is basically nothing more than a complete book of rules for EMTP input and output. And as the modeling capability of the EMTP expands without any obvious bound (program size is about 70000 UTPF statements as of the "M31." version of November, 1982), documentation of the rules begins to resemble more and more the Manhattan Yellow Pages. Any beginner needs help of various other forms.

By far the best way to learn about EMTP capability and usage is by working beside a competent, experienced veteran. Those power organizations which have been using the EMTP for a broad range of power system simulation, and which have not suffered disabling personnel changes, represent the ideal learning environment. If the reader is working for such an organization, he should count his blessings, and disregard most of what follows. In case of questions or problems, go see the local experts. Always ask questions (EMTP users have to get into the habit, since they will be doing it until the day they retire, so broad and complex is transient simulation)!

For those not so blessed by local experts, the next-best alternative is a strong national or regional EMTP Users Group. The need was first appreciated by the Japanese, who were organized by Dr. Akihiro Ametani, Professor of Electrical Engineering at Doshisha University (see "Japan" in index for address). Something like 24 industrial organizations and four universities are involved. Next came the Brazilians (see Ref. 7, Vol. XI, 18 October 1981, page SSIA-1), the Europeans (same volume, 3 October 1981, pages IONM-11 through 14), and most recently the Australians. EMTP usage has grown so large that we at BPA simply can not correspond individually with all EMTP users. If any user or EMTP-interest^{ed} party seeks EMTP information, we first request that he try his national or regional organization, for those parts of the world where these exist. Only write or call Portland if the national or regional user support is unable to answer the question. Further, if you do write to Portland, be sure to send a copy of the letter to the national or regional EMTP organization, to keep them informed. National or regional EMTP user organizations have been placed on the primary distribution list for EMTP Memoranda (Ref. 7), so such information is thereby available before enough memos have accumulated to be bound into a new volume. Given the existing national or regional organizations, perhaps the greatest need now resides very close to home: the USA and/or Canada. Are there any volunteers who would provide secondary printing and distribution of EMTP Memoranda and other printed EMTP materials in exchange for being placed on the primary distribution list? Unless BPA management decides to massively support printing and mailing activities, it is to be predicted that available personnel will concentrate on those who are organized so as to help themselves, those for whom our limited resources can do the most good. While no promises can be made for future support of even organized EMTP user groups, it seems obvious that the prospects for those who are organized are much better than for those who are not. Think about it, EMTP users!

Since I have just warned Japanese, Latin Americans, Europeans, Australians, and Indians to seek assistance from their own EMTP Users Group before writing to BPA, it seems appropriate that I unify all of the names and addresses of interest:

EMTP USERS GROUPS

Dr. Akihiro Ametani, Professor
Chairman, Japanese EMTP Committee
Faculty of Electric Engineering
Doshisha University
Kyoto 602
JAPAN

} Japan

Mr. Marco Polo Pereira
Chairman, Latin American EMTP Users Group
FURNAS CENTRAIS ELETRICAS S A
Rua Real Grandeza, 219
20000 Rio de Janeiro RJ
BRAZIL

} Latin America

Prof. Dr. Daniel Van Dommelen
Chairman, EMTP Users Group Europe
Elektrotechnisch Instituut - Departm. E
Katholieke Universiteit Leuven
Kard. Mercierlaan 94
B-3030 Leuven - Heverlee
BELGIUM (BELGIQUE)

} Europe

Dr. Brian J. Elliott
System Development Division
Electricity Commission of N.S.W.
Box 5257, G.P.O.
Sydney, New South Wales
AUSTRALIA

} Australia

Mr. S. D. Tyagi, Deputy General Manager
EDP and Management Services Department
National Thermal Power Corporation Ltd.
NTPC Square, 62-69, Nehru Place
New Delhi - 110 019
INDIA

} India

INDIA is the most recent addition, with NTPC agreeing to coordinate EMTP activity for that country in a letter from Mr. Tyagi dated 25 January 1984. Memoranda, Newsletters, and the "M34."-vintage Rule Book were all air mailed to NTPC around the end of January, to supply the reference library of the Users Group.

EMTP education is being handled separately, and materials related to it are not available through BPA (so do not write to Portland for a copy). Beginning in June of 1978, a one-week EMTP short course has been offered at the University of Wisconsin, for four consecutive summers. It was given in the sixth year (1983), too, and is scheduled for 1984 as well. This is basically an introductory course. Europeans are offering an advanced course during the summer of 1984, at K.U.L., 15 or 20 mile from Brussels, Belgium. Other less prominent courses have been offered, too. The EMTP Newsletter (see index) should always announce such offerings, with the November 1983 issue relevant to the just-mentioned 1984 courses.

In passing, it might be mentioned that a portion of the EMTF materials used here at BPA are proprietary, and not available from us. Specifically, I am referring to CalComp (or simulated-CalComp) plotting routines as required by EMTF batch-mode plotting, and also the Tektronix PLOT10 (or simulated-Tektronix PLOT10) Terminal Control System routines as required by the interactive plotting program TPLOT. Such software must either be written by the user, or it must be purchased from a vendor, in order to satisfy externals like "LINE", "SCALE", "AXIS", "AOUTST", "MOVABS", etc.

Virtual computer architecture, and its relation to quality support of the EMTF, deserve a few words of explanation. The issue is not one of size, I might point out, since both very small machines (e.g., a \$25K Apollo) and very large ones (e.g., a multi-million dollar IBM offering) use virtual memory management. Rather, the issue concerns satisfaction of some very special needs of the EMTF. Most important is the dimensioning problem. With 26 independent dimensioning controls, the sizing of EMTF tables poses a serious potential problem for the non-virtual computer shop which is used to solve a variety of transient problems. If one attempts to minimize the memory requirement by sizing EMTF tables parsimoniously, then the burden of frequent "VARDIM" use, and re-linkage-editing of the EMTF, must be expected. We at BPA know, having had years of experience in this mode of usage with our former CDC-6500. On the other hand, if the non-virtual computer actually has sufficient physical memory, such frequent redimensioning can be avoided only at the expense of hogging the expensive memory --- a practice that is frowned on by computer centers or their pricing algorithms. Thus the EMTF poses a fundamental problem for non-virtual computers, and the freedom of virtual memory management should be appreciated by most EMTF users. With virtual architecture, the EMTF is dimensioned enormously, and then "paging" serves to extract only the required portions of the oversized tables, and only those parts of the code which are needed. In this respect, those systems with no front-end load (no delay before execution begins) have a decided advantage.

A general recommendation about computer systems for support of the EMTP can be made: if the user has a choice, that system which is the most interactive, and which is the most nearly under user control, is to be preferred, generally. Carefully selected minicomputers have proven to be ideal for support of the EMTP. Indeed, BPA itself gave up the use of its CDC mainframes and switched to a transients-dedicated DEC VAX-11/780 in February, 1979. Minnesota Power pioneered the way with PRIME minicomputers, and their continued support for this EMTP version has made it among the most reliable and flexible. During December of 1981, Minnesota Power and BPA cooperated in the EMTP testing of a microcomputer (Apollo), and it now appears certain that a whole new class of computers will play an important EMTP role in the future. An EMTP-incompatible computer which has FORTRAN and which is not limited by 16-bit addressing has yet to be found, so one can assume acceptability until proven otherwise. Interactivity between the user and the program is very important, so choose among available computers carefully. The forty or so pages following Section 0.5 are dedicated to different EMTP versions, and readers with a choice are encouraged to survey this material for their computers of interest. If some brand can not be found, feel free to describe your system to us in Portland.

I would point out that this Rule Book contains almost nothing about what is happening in the world of EMTP usage and development. It may well contain numerous errors as well, for it is prepared under considerable time pressure. For EMTP-related announcements, reports of interesting studies by program users, corrections to the Rule Book and/or common program versions, and summaries of ongoing EMTP research, we recommend the EMTP Newsletter which is published by the Leuven EMTP Center (LEC) in Belgium:

Prof. Dr. Daniel Van Dommelen
 Chairman, Leuven EMTP Center of
 the European EMTP Users Group
 Elektrotechnisch Instituut - Departm. E
 Katholieke Universiteit Leuven
 Kard. Mercierlaan 94
 B-3030 Leuven - Heverlee
 BELGIUM (BELGIQUE)

Each and every

EMTP user is expected to be aware of the material in this publication. Don't write to Portland for a report of "how things are going" if you do not read each and every issue! A subscription form that was received in Portland on 7 February 1986 will be found below.

EMTP
NEWSLETTER

INVOICE AND SUBSCRIPTION FORM FOR "EMTP NEWSLETTER"- VOLUME 6

January 1986 -- January 1987 (4 issues)

Subscriber's coordinates:

Date: _____

Title: _____ Initials: _____ Name: _____

Company: _____

Address: _____

Zip + City: _____

Country: _____

Number of copies requested: _____

Payment: (also see instructions below)

Member of LEC (Y/N)? _____ (LEC is the Leuven Emtp Center, part
of the European EMTP User's Group)

Bank transfer executed on ___/___/'86 at bank: _____

Receipt required (Y/N)? _____ Signature: _____

Instructions:

Members of LEC: NO subscription fee (one copy)
(only effective after returning this subscription form)
(any additional copy : see "non-members of LEC")Non-members of LEC: subscription fee is 35 US \$ (one copy)Please pay by bank transfer to
"K.U.Leuven R&D", account number 330-0633504-51
at Bank Brussel Lambert, Leuven, Belgium

Reason of payment: EMTP Newsletter

Please return this form to: Ir.G.Empereur
K.U.Leuven, Dept.Electrotechniek
Kardinaal Mercierlaan, 94
B-3030 Heverlee (Leuven)
BELGIUM-----
IMPORTANT - IMPORTANT - IMPORTANT - IMPORTANT - IMPORTANT
- If subscribing through a library or subscription agency -Please forward this form as invoice to your library or sub-
scription agency. No invoice will be mailed to the library or
subscription agency directly. However, receipt of payment, if
requested, will be acknowledged to the library or subscription
agency.0.1 Availability of Program to OthersIn conformity with long-standing BPA policy, dissemination of
materials related to the Electromagnetic Transients Program (EMTP, or

T.P. in the older notation) is made freely to any and all interested parties. A fee to cover reproduction, handling, and mailing costs may be assessed against the organization or individual receiving the materials, however. No claim or warranty as to the usefulness, accuracy, fidelity, or completeness of these materials is, or ever has been, in any way expressed or implied

It is only for potential program users having the same computer system as BPA (currently a DEC VAX-11/780 minicomputer, or Apollo micro-computer) that the EMTP probably can be procured most conveniently through that organization. For other computer systems of interest (IBM, Honeywell, PRIME, Univac, SEL, CDC, Cray-1, etc. distribution will most often be handled through one or more program users of the computer system in question, on a cost or near-cost basis. The advantage of this procedure is that standard manufacturer-dependent tape-copy routines can be used, the tape will be recorded with an acceptable number of tracks and at a proper density, and line printer files corresponding to sample solutions will also generally be put on the tape as well, for purposes of verification. Information as to who is handling distribution of the EMTP for other computer systems is available through Program Maintenance at BPA, among other places. But first read Section 0.5a onward -- that section which corresponds to the computer system of interest. Only if the desired computer is not found, or if the information contained there is incomplete, inquire of Program Maintenance at BPA.

0.2 Program Maintenance and Development

Dr. Hermann W. Dommel, founding father of the EMTP, left BPA for the University of British Columbia in Vancouver during July of 1973. Primary responsibility for EMTP maintenance and development at BPA then shifted to Dr. W. Scott Meyer (address and phone number as on the cover), with Dr. Tsu-huei Liu (same address and phone) added to the effort in October of 1975.

So much for BPA and ancient history (back when the program was small, and manageable, and when most of us still nurtured the naive hope of someday finishing it). A new phase of EMTP development was begun during 1975, after the discovery of machine translation (see Ref. 13) the cooperative development among major program users, for the mutual benefit of all. Very substantial contributions to the present EMTP have been made by non-BPA personnel (though BPA funding has supported most work at other than power companies). Three other North American power companies have been actively involved in development, as have four universities:

1. The original dynamic synchronous machine (S.M.) of the EMTP was contributed by the Southern California Edison Co. (SCE) of Rosemead, California (the Los Angeles area). Mike Hall and John Alms did the development work there, as documented in Ref. 8, Volume VI, 5 December 1976, pagination FOTS. Much of the theoretical basis came from Dr. George Gross of Pacific Gas & Electric (San Francisco). That original code was considerably enhanced since its 1976 introduction to the EMTP, thanks to Dr. Vladimir Brandwajn (originally a student of Prof. Dommel, then a contractor of BPA for about a year. Between 1978 and 1982, Dr. Brandwajn handled all

EMTP considerations related to the conventional S.M code, whether it be the original SCE code, or his own (Type-59) modeling. Before moving to Systems Control in 1982, Vladimir removed the Type 50 (original SCE) modeling.

2. The Semlyen recursive convolution modeling of Section 1.27a comes from Ontario Hydro (OH) of Toronto, Ontario (Canada). It is named after Professor Adam Semlyen of the University of Toronto, who inspired it (see Refs. 10, 21). Alex Dabuleanu (now deceased; formerly an OH employee) did much of the original work, as a student of Prof. Semlyen. Through the end of 1979, Russell Brierley of OH continued to be the premier expert in use of the feature, and researcher who paved the way for generalization to complex exponentials (theory as per Ref. 21 by Prof. Semlyen). Bob Eifrig of Oregon State University (and a temporary BPA employee for several summers) restructured the original Semlyen code during the summer of 1976 (variable dimensioning, etc.). Then during the summer of 1978, Bob completely recoded the solution code, to allow for an arbitrary number of complex exponentials, following the Ontario Hydro recommendation. Bob did work on the associated new "SEMLYEN SETUP" (prototype which came from Russ Brierley and Vladimir), though a workable production tool never resulted. See Point 9 below.
3. The dynamic surge arrester for SiC devices with active current limiting gaps as described in Section 1.34 was developed and contributed by Chuck Wolf and Dr. Arun Phadke of the American Electric Power (AEP) Service Corporation of New York City.
4. The original mathematical formulation and crude outlines of TACS (see Section 8.), which is used for control system modeling, was developed by Laurent Dube, studying under the supervision of Prof. Hermann W. Dommel at the University of British Columbia in Vancouver. See Ref. 12. Implementation and enhancement in the EMTP were made by Laurent working under contract with BPA. This included the valve and diode modeling of Section 1.43. Laurent's first BPA contract ended in the summer of 1976, and a second began in the spring of 1979, as a second generation of TACS is being developed. How much of the new goodies make the general distribution during the summer of 1980 is not now (March, 1980) clear.
5. Professor Akihiro ("Aki") Ametani of Doshisha University in Kyoto (Japan) developed the "CABLE CONSTANTS" code of Section 7.7; and he also inspired the "Ametani linear convolution" modeling (see Ref. 11), the implementation of which was designed and performed by Bob Eifrig. Yet this UTPF overlay 46 was removed during 1983.
6. The Type-96 hysteretic inductor modeling of Section 1.31 was developed by Prof. Narendra ("Ned") Mohan and Mr. Jim Frame of the University of Minnesota in Minneapolis. This was during 1978 and 1979, under contract with BPA.
7. The universal machine (U.M.) modeling of Section 1.63 was developed by Prof. Hian Lauw of Oregon State University in Corvallis, Oregon. This was during 1979 and 1980, under contract with BPA.

8. The Type-59 dynamic synchronous machine (S.M.) modeling of Section 1.62 was originally researched by Dr. Vladimir Brandwajn while studying for his doctorate in Vancouver (another of Prof. Dommel's graduate students). See Ref. 15. Implementation in the EMTP was under contract with BPA (see Ref. 8, Vol. VII, 23 December 1977, pagination CBVB). Between 1978 and 1982, Vladimir was with Ontario Hydro, and has since moved to Systems Control, Inc. of Palo Alto, California.

9. Dr. John Hauer of BPA joined the EMTP development effort during the late fall of 1979, to rescue our suspended "SEMLYEN SETUP" work. See Ref. 8, Vol. IX, 4 October 1979, page EDTO-1. Rather than correcting past work, he added his own self-contained, sophisticated, frequency-domain fitting program that has evolved over the past decade or two. This "HAUER SETUP" code of UTPF overlays 48 and 49 existed until 1983, when it was removed ("MARTI SETUP" is the general replacement).

10. Prof. Jose R. Marti of Central University of Venezuela (in Caracas) finished his doctoral study under Prof. Hermann Dommel at UBC in 1981. Jose's dissertation concerned a new, simplified procedure for the frequency-dependent representation of transmission lines in a transients program. Implementation in the EMTP began in August of 1981, and continued through the following summer, under contract with BPA. See Sections 1.26b1 and 7.0.

11. Ma Ren-ming from the Wuhan High Voltage Institute (Wuhan, China) moved to Portland during March of 1982, and has been an integral part of the program support team ever since. During late 1983 and early 1984, he made very extensive improvements to TACS modeling. Other projects with which Ma has been closely involved are the new EMTP switch logic, and refinement of the EMTP load flow. When Ma Ren-ming returns home during the summer of 1984, his presence will be sorely missed. For the first two years of his stay, salary, travel, and living expenses were all provided by his institute, for which all users should be grateful.

12. Frank Rasmussen of Elkraft Power Corporation in Denmark did background research, and delivered the initial workable code for what is now referred to as the EMTP load flow. See Ref. 8, Vol. XIII, 23 July 1983, Section II, pages VDEL-2 through 9.

Hence there is quite a bit of EMTP competence which is spread among many individuals. The effort was long ago bigger than any one person, group of persons, or even power pool. Industry-wide development on an international scale has been involved. The coordination has been centered largely in Portland (at BPA), if only by default. But then the possibility of better-coordinated and better-funded development motivated the establishment of the EMTP Development Coordination Group (DCG) in the fall of 1982. As of April, 1984, DCG support for S.M. and U.M. contractors (Dr. Brandwajn and Prof. Lauw) has resulted in obvious, observable, deliverable improvements to the program, and would seem to be DCG's prime accomplishment.

A new EMTP user is encouraged to seek assistance within his own company when using the program for the first time, or when using it in a new mode. If there are questions as to program and/or problem restrictions, an inquiry to experienced personnel is almost always advisable. The EMTP and associated problem modeling are inimitably tricky and sophisticated, with experience invaluable in order to avoid experimentation of a trial and error (garbage in, garbage out) nature. For those who are able to spend corporate funds, and travel of centers of EMTP education, I strongly recommend any course sponsored by "EMTP insiders".

0.3 Program Capability (Summary)

The Transients Program is used to solve the ordinary differential and/or algebraic equations associated with an "arbitrary" interconnection of the following elements:

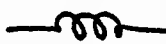
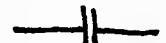
1. Lumped resistance:  $v = Ri$
2. Lumped inductance:  $v = L di/dt$
3. Lumped capacitance:  $i = C dv/dt$

4. Multiphase Pi-equivalents, where the preceding scalar R, L, C become symmetric square matrices $[R]$, $[L]$, $[C]$.

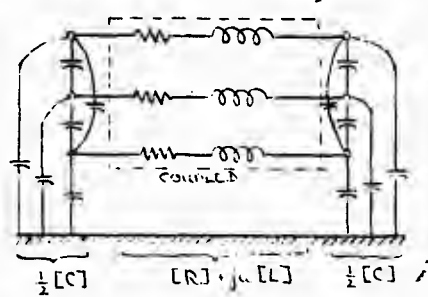

5. Multiphase distributed-parameter transmission lines, wherein propagation time of the line is represented. Distortionless and externally-lumped-resistance approximations are available, as well as "exact" frequency-dependent representations.

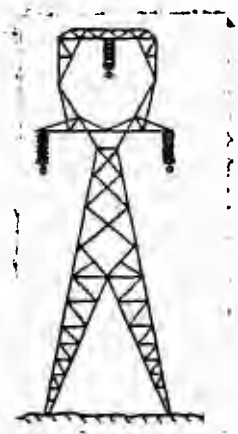

6. Nonlinear resistors, where the curve must be single-valued.

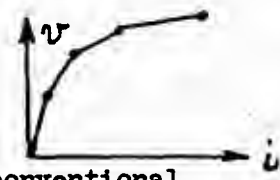

7. Nonlinear inductors, either with the conventional single-valued characteristic (see sketch at right), or including hysteresis.

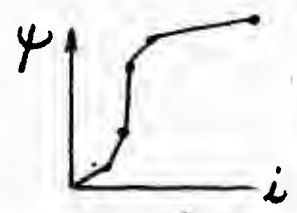

8. Time-varying resistance.



9. Switches, used to simulate circuit breakers, lightning-arrestor flashover, or any other network connection change. Diodes and dc converter valves are included

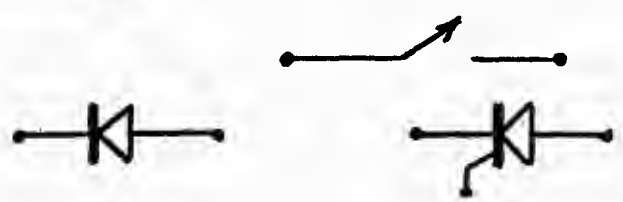

10. Voltage or current sources. In addition to standard mathematical functions (sinusoids, surge functions, steps, and ramps), the user may specify sources point by point as functions of time, or in FORTRAN, or as defined by TACS (see Point 12 below).

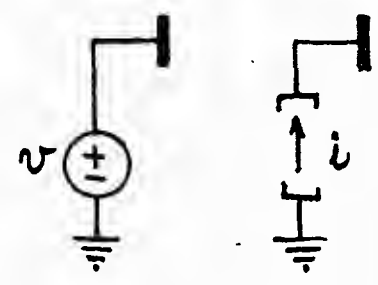

11. Dynamic synchronous machines (3-phase balanced design only). The electrical side is represented by Park's (Blondel's) equations, while the mechanical side is modeled as an interconnection of masses, springs, and damping. Arbitrary exciter and governor dynamics can be represented, by connection to TACS (see Point 12).

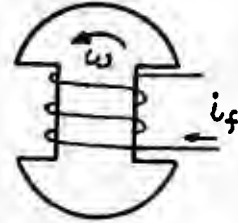

12. Control system dynamics, as are normally represented on differential analyzers (analog computers). This modeling capability goes by the name of TACS (an acronym for Transient Analysis of Control Systems). Nonlinear and logical operations may be represented. Input and output may be interfaced with the electric network of the EMTP, providing a hybrid representation. All TACS representation is user-patchable, and hence configuration free. See Sect. 8.

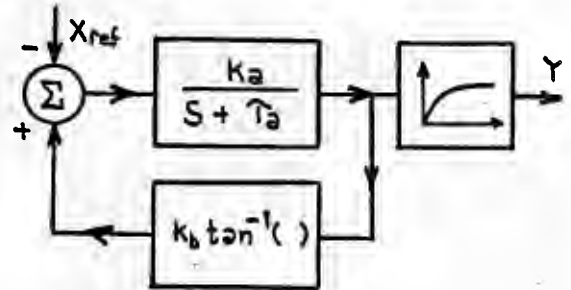

13. Unconventional rotating electromechanical energy converters of various sorts, including induction machines and dc machines. An arbitrary number of windings on each rotor axis is allowed, there is no restriction to 3-phase usage, etc. Compensation is used, and any mass-spring dynamics of the shaft are represented by an electrical analog. Various control system connections are possible, via TACS. Refer to Section 1.63 (the universal machine model).

Trapezoidal-rule (second-order) implicit integration is used on the describing equations of most elements which are described by ordinary differential equations. The result is to form an associated set of real, simultaneous, algebraic equations which must be solved at each time step (see Ref. 1). These are placed in nodal-admittance form (with new unknown voltages as variables), and are solved by ordered triangular factorization (Ref. 4).

Program output consists of component variables (e.g., branch currents or voltages, machine torques or speeds, etc.) as functions of time, for those variables which were requested by the user. Both printed and plotted output is possible, with plotting possible in either character or vector-graphic modes. See Section 5.0 for the separate, disconnected usage of vector plotting, and Section 9.0 for the details of interactive (SPY) usage.

Initial conditions for differential equations of the various components can be determined automatically by the program for many if not most cases of practical interest. The most important restriction is to linear elements (nonlinear components must generally be ignored during phasor steady-state solutions). Yet injections of the electric network may be specified in terms of power and voltage magnitude, thereby providing multi-phase load flow capability. Control system modeling (TACS) allows for the superposition of an arbitrary number of linear phasor solutions of different frequencies.

0.4 Supporting Reference Material

Theory behind the EMTP is scattered through various technical papers and a few books. The following may be found useful for reference purposes:

1. H. W. Dommel "Digital computer solution of electromagnetic transients in single and multiphase networks " IEEE Trans., vol. PAS 88, pp. 388-399, April 1969
2. H. W. Dommel. "Nonlinear and time varying elements in digital simulation of electromagnetic transients." IEEE Trans vol. PAS. 90, pp. 2561 2567, Nov/Dec 1971.
3. W. S. Meyer H. W Dommel, "Numerical modelling of frequency dependent transmission line parameters in an electromagnetic transients program " IEEE Trans , vol. PAS-93, pp. 1401 1409. Sep/Oct 1974.
4. W. F. Tinney, J. W. Walker, "Direct solutions of sparse network equations by optimally ordered triangular factorization," Proc. IEEE, vol 55 pp. 1801-1809, November 1967. Also available in 1967 IEEE PES PICA Conference Record.
7. H. W. Dommel, W. S. Meyer, "Computation of electromagnetic transients," Proc. IEEE, vol. 62, pp. 983-993, July 1974.
8. W. S. Meyer, "Transients Program Memoranda." Approximately 150 pages per volume, this concerns the EMTP development memoranda which are regular issued as progress is made. Individual memos are bound when there has been sufficient accumulation to form a volume. As of February, 1984, there were 14 volumes. Only the most recent volume is generally available, however, so do not write requesting a complete set. Older volumes are out of print. When a new volume is released, a fixed number of copies are printed; and when these are exhausted, the volume becomes unavailable through regular channels (a Freedom of Information request would always be honored, of course, but a copying fee would be charged). As of April, 1984, Memoranda writing has been suspended indefinitely with the 74-page contribution dated 19#January 1984 (finished on 25 March 1984) being the final one unless management encourages a resumption. A request for guidance in setting such priorities was made of higher management on March 26th, 1984.
9. D. R. Carroll, W. S. Meyer, "Digital and hybrid computation of electromagnetic transients in power networks." Sixth Annual Pittsburg Conference on Modeling and Simulation, Pittsburg, Pennsylvania, April 1975.
10. A. Semlyen, A. Dabuleanu, "Fast and accurate switching transient calculations on transmission lines with ground return using recursive convolutions," IEEE Trans., vol. PAS 94, pp. 561-571, 1975.
11. A. Ametani, "A highly efficient method for calculating transmission line transients," IEEE Trans., vol. PAS-95 pp. 1545 1551, Sept/Oct 1976.

12. L. Dube, H. W. Dommel, "Simulation of control systems in an electromagnetic transients program with TACS," IEEE PES PICA Conference Record, vol. 10, pp. 266-271, 1977.
13. W. S. Meyer, "Machine translation of an electromagnetic transients program (EMTP) among different digital computer systems," IEEE PES PICA Conference Record, vol. 10, pp. 272-277, 1977. See also Ref. 8, Vol. VI, 5 January 1977, pagination PICA.
14. V. Brandwajn, H. W. Dommel, "Synchronous machine parameters in analysis of electromagnetic transients," Canadian Communications and Power Conference, Montreal (P.Q., Canada), October 20-22, 1976.
15. V. Brandwajn, "Synchronous Generator Models for the Simulation of Electromagnetic Transients." Ph.D. thesis written at the University of British Columbia (Vancouver, B.C., Canada), April 1977, 117 pages plus preface.
16. G. Gross and M. C. Hall, "Synchronous machine and torsional dynamics simulation in the computation of electromagnetic transients," IEEE Trans., vol. PAS-97, pp. 1074-1086, July/Aug 1978.
18. IEEE SSR Task Force, "First benchmark model for computer simulation of subsynchronous resonance," IEEE Trans., vol. PAS-96, pp. 1565-1572, Sept/Oct 1977.
19. P. M. Anderson, A. A. Fouad, "Power System Control and Stability." Ames, Iowa (USA): The Iowa State University Press, 1977.
20. V. Brandwajn, H. W. Dommel, "A new method for interfacing generator models with an electromagnetic transients program," IEEE PES PICA Conference Record, Vol. 10, pp. 260-265, 1977.
21. A. Semlyen, "Contributions to the theory of calculation of electromagnetic transients on transmission lines with frequency dependent parameters," paper submitted to IEEE for presentation at the 1979 PES Summer Meeting.
22. D. Van Dommelen, Editor, "EMTP Newsletter." Published about 4 times/year in Leuven, Belgium, issue number one appeared during July of 1979. For information about subscription, see "Newsletter" or "Europe" or "LEC" in the index.
23. V. Brandwajn, W. S. Meyer, H. W. Dommel, "Synchronous machine initialization for unbalanced network conditions within an electromagnetic transients program," IEEE PES PICA Conference Record, vol. 11, pp. ???-???, 1979. Also available in Ref. 8, Vol. VII, 28 January 1978, pages TDCE-13 through 16.

24. H. W. Dommel, B.C. Chiu, W. S. Meyer, "Analyzing transients in ac/dc systems with the BPA Electromagnetic Transients Program," Proc. IEEE International Conference on Overvoltages and Compensation on Integrated ac-dc Systems, Winnipeg, Canada, July 8-12, 1980.
25. A. Ametani, "A general formulation of impedance and admittance of cables," IEEE Trans., vol. PAS-99(3), pp. 902-910, 1980.
26. A. Ametani, "Wave propagation characteristics of cables," IEEE Trans., vol. PAS-99, No. 2, pp. 499-505, March/April 1980.
27. R. H. Lasseter, D. M. Demarest, F. J. Ellert, "Transient Overvoltages on the neutral bus of HVDC transmission systems," IEEE PES paper No. A78 707-4, presented at the 1978 Summer Meeting.
28. R. H. Lasseter, "Electrical characteristics of long overhead HVDC transmission lines," IEEE PES paper No. A79 535-6, presented at the 1979 Summer Meeting.
29. A. G. Phadke, Course Organizer: "Digital Simulation of Electrical Transient Phenomena." IEEE Tutorial Course No. 81 EHO173-5-PWR, last given at the 1982 IEEE PES Winter Meeting in New York City. Sixty pages in length, the notes for this one-day IEEE course consist of six chapters, as follows:
 - I --- Introduction to Power System Transients (A. G. Phadke);
 - II --- Present day procedures and program (W. S. Meyer);
 - III --- Extension of the basic solution methods (H. W. Dommel);
 - IV --- Synchronous machine modeling (D. W. Olive);
 - V --- EMTP synchronous machine modeling (D. H. Baker);
 - VI --- HVDC converters & controls (K. G. Fehrle, R. H. Lasseter).
 Anyone seeking a broad overview of the full range of EMTP usage is advised to consult this "book". Although just an outline, it points to numerous other sources of information (there are 145 references), and is the only known such organized summary.
30. K. C. Lee, H. W. Dommel, "Addition of modal analysis to the U.B.C. Line Constants Program," research report to B.C. Hydro and Power Authority, Vancouver, Canada, January, 1980, published by the Electrical Engineering Department of the University of British Columbia.
31. J. G. Frame, N. Mohan, T.-H. Liu, "Hysteresis modeling in an electromagnetic transients program," IEEE PES paper No. 82 WM 152-7, presented at the 1982 Winter Meeting.
32. R. H. Lasseter, S. Y. Lee, "Digital simulation of static VAR system transients," IEEE PES paper No. 82 WM 178-2, presented at the 1982 Winter Meeting.
33. V. Brandwajn, H. W. Dommel, I. I. Dommel, "Matrix representation of three-phase N-winding transformers for steady-state and transient studies," IEEE PES paper No. 81 SM 429-0, presented at the 1981 Summer Meeting.
34. H. W. Dommel, "Transformer models in the simulation of electromagnetic transients," Fifth Power Systems Computation Conference held in Cambridge, England, September 1-5, 1975.

35. A. S. Morched, V. Brandwajn, "Transmission network equivalents for electromagnetic transients studies," IEEE PES paper No. 83 WM 039-5, presented at the 1983 Winter Meeting.
36. H. K. Lauw, W. S. Meyer, "Universal machine modeling for the representation of rotating electric machinery in an electromagnetic transients program," IEEE PES paper No. 81 SM 430-8, presented at the 1981 Summer Meeting. Published in Trans. PA&S during April of 1982?
37. D. Van Dommelen, "Optimization of initial values of mechanical variables of turbine-generator units in an electromagnetic transients program," IEEE PES paper No. 81 SM 500-8, presented at the 1981 Summer Meeting, and later published in Trans. PA&S, Vol. PAS-100, no. 12, pp. 4990-4994, December 1981.
38. IEEE Working Group, "Modeling of Current-Limiting Surge Arresters", IEEE Trans. PA&S, vol. PAS-100, pp.4033-4040, August 1981.
39. J.R. Marti, "Accurate Modelling of Frequency-Dependent Transmission Lines in Electromagnetic Transients Simulations", Pro. IEEE Power Industry Computer Applications (PICA) Conference, Philadelphia, PA, 9 pages, May 1981.
40. V. Brandwajn, H. W. Dommel, "Numerical oscillations in the transient analysis of circuits with implicit integration techniques," paper presented at the XXIV-th Midwestern Symposium on Circuits and Systems, Puebla, Mexico, August, 1983.
41. D. Van Dommelen, Chairman. The European EMTP Users Group (see index) has held meetings biannually since its inception during 1981 (the first meeting, an all-Belgian affair, took place on 21 January 1981). Each meeting has an associated set of conference documents, of which some have been listed in EMTP Memoranda (e.g., Ref. 8, Vol. XIV, 2 January 1984, pages FMOE-1 and 2). Anyone interested in EMTP usage should not overlook this valuable source of information about the program.
42. F. L. Alvarado, R. H. Lasseter, H. Kwon, S. K. Mong, "A module-oriented EMTP interface," paper presented at the 1984 Winter Meeting of the IEEE PES in Dallas, Texas.
43. Frank Rasmussen of ElKraft Power Company Ltd., Copenhagen, Denmark, is encouraged to write a paper describing his pioneering research and development which made the EMTP load flow possible. If and when this appears, it will be Reference 43.

0.5 Program Availability on Different Computer Systems and Installations

The EMTP is being made available for execution on the different major American computer systems by means of machine translation of an installation-independent master file known as the Universal Transients Program File (abbreviated UTPF). Conceived of in November of 1974 (see Ref. 13), this scheme utilizes a different Editor/Translator (E/T) program for each different computer system, so as to machine-process the UTPF, to convert it into legal EMTP FORTRAN for the particular installation of interest. Thus all EMTP code actually begins with the same master file (the UTPF), but differs according to the built-in or specially-requested properties of the translation. Within this framework, the writing of a common EMTP User's Manual for all is thus a little bit tricky.

Some differences of the EMTP code for different computer systems are completely hidden, out of sight of the program user, and are of no concern to him. For example, alphanumeric storage (e.g., the 6-character names for network busses) on Univac is handled in FORTRAN INTEGER variables, while on IBM the mode is REAL*8. This is a concern of the program developers only, not of any normal interest to the user. Reference 13 summarizes the entire process.

Other machine differences affect the user in only a minor way, and he may not even initially be aware of them. For example, computer word length dictates certain precision or other numerical requirements on the input data. Control Data with its big 60-bit word is more tolerant of a wide disparity of input data than is Univac with its 36-bit word, for example. Here we are talking about limits which exist for all EMTP users, but which vary in severity or value according to the computer installation being considered. Relevant comments about such considerations will be found in the user instructions, where appropriate. The user should always be aware of the computer word length used in his EMTP translation, needless to say.

Finally, certain EMTP operations are totally different for different installations, at least in outward appearance, as far as the user is concerned. For example, computers of different manufacture (IBM, CDC, Univac, SEL, etc.) will require completely different job control cards, in general. These are the instructions by means of which one pleads with the installations operating system, asking for the EMTP, manipulating his data input files and the program output. Such job control language (JCL) may even vary among different installations of the same manufacturer, due to local preferences or constraints which are placed on the mode of operation. If in doubt as to what to employ, the user should always contact his resident EMTP expert for the last word. Yet as a general guide, the following "system" instructions as to EMTP setup are typical, for the different computer systems indicated. Refer to Section 0.5a onward --- that section applicable to the computer system of interest.

As summarized in Reference 13, FORTRAN statements which are highly dependent on computer manufacturer and/or installation usage have been isolated in installation-dependent EMTP modules. If a given organization performs its own translation, such modules will be set up to satisfy its own peculiar needs, and Program Maintenance of that organization should thoroughly understand the decisions which have been made; in this case, there should be no complication at all. But, if a given organization receives a FORTRAN copy of the EMTP from some other group which uses a computer of the same manufacture, then perhaps nothing will be known about installation-dependent modules and the installation-dependent choices which may have been

made therein. In order to be able to change some of these decisions if need be, the user must know how to locate the modules of interest. The following chart shows all installation-dependent EMTF modules by name and also overlay numbers. The purpose is summarized on the right (for more description, consult comment cards at the top of the module in the UTPF [which contains VAX copies]).

Module Name	UTPF overlay name and	Purpose of installation-dependent code
EREXIT	MAIN00; -1	Once used for error recovery (mnemonically "Error EXIT") on BPA's old CDC-6500, for five years this was a dummy module. Then, with interactivity, it was used again. The UTPF has a VAX module with a call to the machine-dependent CTRL-C handler, so all other computers will substitute for it.
RUNTYM		Find the current central processor and input/output job times. Basically, this is used only for the elapsed-time printout of the case-summary statistics.
TIME44		Find the current wall-clock time, in format "HH.MM.SS". Automatic plot file naming (for those systems having OPEN/CLOSE capability of FORTRAN) is based on the digits of this time, and also on "DATE44" results.
CIMAGE		Read the next data card from unit LUNIT5. DECODE it as 80A1 if free-format is used. Check for any \$-cards, all of which are processed within "CIMAGE". Skip over comment cards (after interpreting).
LOCF		Find the address in memory of the argument, as a number of REAL words. This is used by the EMTF to find the size of certain fixed-dimension arrays (not all code is variably-dimensioned).
LOCINT		Find the address in memory of the argument, as a number of INTEGER words. This is a scaled version of "LOCF", fundamentally.
RFUNL1 RFUNL2 RFUNL3 CFUNL1 CMPLXZ		All library functions are defined using ENTRY points in these modules, for those systems allowing ENTRY usage. Neutral names are used (e.g., "SINZ" is used for the usual "SIN" or "DSIN"). Special limit checking can also be placed in these modules.

viii-1a

DLIBRF

Used to provide double-precision library functions, originally just for overlay 13, for use by the Semlyen recursive convolution code.

DLIBR2

Used to provide double-precision library functions of 2 arguments.

FRENUM

Returns a floating-point number from the next free-field range on the data card which is currently being processed by the universal module "FREFLD".

PACKA1

Packs one character (A1 information) of one word into any character position of another words. Both words must be ALPHANUMERIC (UTPF type).

PACKCH

Packs A4 or A6 word strings into ALPHANUMERIC vector storage so that there are no imbedded blanks. This was originally designed for CalComp plotting, to remove excess blanks.

SEEDY

Find the number of seconds since midnight, based on alphanumeric input of the time ("HH.MM.SS").

RANDNM

Compute a random number (roll the dice), uniformly distributed over the unit interval (0, 1). This is for zero argument. For nonzero argument, initialize the random number generator using this seed. "RANDNM" also has access to standard random numbers of "SANDNM" if user-requested.

TAPSAV

MAIN10; 0

This module is called by the universal "TABLES" to dump/restore /LABEL/ as part of "START AGAIN", "STATISTICS", etc. usage. The UTPF module (VAX code) assumes COMMON blocks are in natural or reverse order, so they can very easily be transferred by a single self-indexed READ/WRITE following LOCINT location of the ends. Computers without such regular order require "TAPSAV" module produced by "VARDIM" (with a separate READ/WRITE for each COMMON block).

PLTFIL

For installation-dependent transfer of output vector to disk as part of plot-file building on LUNIT4. Conversion to single-precision (assuming EMTP computation uses REAL*8) is a common function, to save disk and I/O time. Interactive EMTP versions service the

viii - 2

<p>PLTLU2</p> <p>VECRSV VECISV</p> <p>VECRXX VECIXX</p>		<p>ROLLing "PLOT" command of SPY from here, too. Module is called only if M4PLOT is nonzero (1=SPY MOS, 2=REAL*4 disk).</p> <p>Special version of "PLTFIL" used only for TACS "STAND ALONE" cases. Module is called only if M4PLOT .NE. 0.</p> <p>Vector dumping/restoring modules used during the overlay 6-11 steady-state phasor solution and node renumbering. "VECRSV" is for REALs, while "VECISV" is for INTEGERS. UTPF (VAX) modules are installation-dependent since they rely on virtual storage (/C29B01/). See Ref. 8, Vol. XII, 24 August 1982, Section II, pages HTNT-4 through 8.</p> <p>Near-universal versions of "VECRSV" and "VECISV", or so we thought (see Ref. 8, Vol. XII, 20 January 1983, Section III-A, pages MVEM-16 and 17.</p>
<p>SYSDEP</p> <p>MIDOV1</p> <p>NAM999</p> <p>DATE44</p> <p>PFATCH</p>	<p>OVER1 ; 1</p>	<p>Performs various system-dependent initializations at the start of execution of a new EMTF data case.</p> <p>Performs miscellaneous system-dependent initializations when EMTF control is ready to exit "OVER1". The call to "SYSDEP" is too early to perform all system-dependent initializations, it turns out.</p> <p>Installation-dependent module which builds default names for linear branches (LIN001, etc.), nonlinear elements (NLN001, etc.), and switches (SWT001, etc.).</p> <p>Find the calendar date ("MM/DD/YY").</p> <p>Attach (connect) a disk file of plot points to I/O unit LUNIT4, in conjunction with "REPLOT" usage of Section 1.0d. "START AGAIN" also requires this module (Section 1.0e15).</p>
<p>ANALYT</p>	<p>OVER16 ; 16</p>	<p>The module which services "ANALYTIC SOURCES USAGE" modeling (user-defined FORTRAN). Also, "EMTPSPY" of interactive control uses "ANALYT" to honor the "RAMP" command (see Ref. 8, Vol. XI, 17 July 1981, page IEEO-35).</p>

Several specific modifications will be of concern to many installations, particularly those which are not in the U.S.A. (where conventions are different). Included are the following:

1. Power system (synchronous; steady-state) frequency

The steady-state frequency of power system operation is defined within module "SYSDEP" of overlay number 1. Variable "STATFR" should be assigned this frequency in Hertz (equal to 60.0 for usual usage within the United States).

2. Calendar date format

As set up for usage in the States, "MM/DD/YY" is printed, where:

"MM" ---- two decimal digits for the month (e.g., "03" for March);
 "DD" ---- two decimal digits for the day within the month;
 "YY" ---- two decimal digits for the year (e.g., "77" for 1977).

In most other parts of the world (including Canada, as I recall), and even in the U.S. Army, I believe that it is common usage for the day "DD" to precede the month "MM". If module "DATE44" (see above chart) is altered so as to produce "DD/MM/YY", then the associated format within subroutine "SYSDEP" (which is used for one or two lines of EMTP heading) should be changed accordingly.

3. Free-field data format characters

As explained in Section 1.0g6, two special characters are used in conjunction with EMTP free-field data input. As of April 1980 ("M27." UTPF idents), a comma is the default separator character "CSEPAR" and a dollar sign is the default continuation character "CHCONT". If local Program Maintenance wants to alter these, it is a trivial matter to change these variable definitions within module "SYSDEP" (see above chart). The only restriction should be obvious: both characters must be unique and distinct from all EMTP data characters. For example, a slash ("/") could not be used along with a data case which involved TACS supplemental variables, since "/" is used to indicate division in Section 8.5.5 data.

4. Batch-mode plotting parameters

Several parameters which are related to batch-mode EMTP plotting (Section 1.10) are defined in module "SYSDEP" (see above chart). The following might be varied, from one installation to another:

SZPLT ----- Height of CalComp plotting paper which is being used, in inches. Or more precisely, this is the maximum vertical excursion of the pen (any margin and sprocket holes thus are not to be counted). Recall that the user is able to over-ride this default value at execution time, using a "PLOTTER PAPER HEIGHT" card of Section 1.0c

- SZBED ----- Maximum length of the plot, in inches. For BPA CDC usage, this is set equal to 72.0 (about the size of our EAI flatbed surface). This parameter is used as an argument of the overlay #31 call to subroutine "PAPRSZ" (whose job it is to protect against illegal excursions of the pen).
- LNPIN ----- The number of lines per inch of the line printer. Recall that the scaling of a line printer plot will depend on this figure. The user is able to over-ride the default value at execution time, using a "PRINTER LINES PER INCH" card of Section 1.0c .
- NSMTH ----- The number of successive ups and downs before averaging of successive points is resorted to, for plot purposes. Recall that the user is able to over-ride this default value at execution time, using a "LIMIT ON PLOT OS" card of Section 1.0c .
- LLBUFF ----- Variable which is used as the second argument of the call to CalComp subroutine "PLOTS" ---- to be found within module "BEGPLT" (see above chart) of overlay #31. As originally used by CalComp a decade or so ago, this was the buffer length of the "LUNIT8" output channel on which plotter instructions will be written. But many installations no longer use such a specification (e.g., the buffer may be automatically set by the system, or it may be defined by the job control language (JCL) cards).

The first executable statement of the program, located in "MAINO0" (overlay number -1) and never executed again, is the assignment of value -3333 to "LLBUFF" . The first time through "SYSDEP" , this is converted to a positive value. Module "BEGPLT" of overlay #31 then could append a minus sign, as a flag that "PLOTS" has been called once, and is not to be called again --- if this is the desired usage. Remember, batch-mode plotting is done by a primary-level overlay, if the program is overlaid. For BPA CDC, this requires that "PLOTS" be called each time the overlay is used (for each data case which uses CalComp plotting). This seems to be quite installation dependent.

5. Input/output unit numbers

Unless explicitly altered to the contrary by Program Maintenance which sets up the translation, the following input/output (I/O) unit assignments will be assumed:

LUNIT5 = 5 ----- card reader (EMTP input data cards)

LUNIT6 = 6 ----- line printer (EMTP printed output)

LUNIT7 = 7 ----- card punch (for EMTP punched-card output)

LUNIT8 = 8 ----- machine-language instructions for plotting hardware
(as generated by calls to the Calcomp subroutines
during the overlay #31 batch-mode plotting)

LUNIT1 = 1 ----- scratch tape; very small buffer will suffice
(for BPA CDC, 64 decimal words were used).

LUNIT2 = 2 ----- scratch tape which is used for dumping most of /BLANK/
and /LABEL/ , to be read back into central memory
for each new energization of a "STATISTICS" or
"SYSTEMATIC" data case. A big buffer is recommended
(for BPA CDC, a buffer of 1024 decimal words was used).

LUNIT3 = 3 ----- Like "LUNIT1"

LUNIT4 = 4 ----- scratch tape which is used for storage of the raw data
points of the plot file (later to be plotted). A good
size buffer is recommended (for BPA CDC, we used 512 decimal
words).

LUNIT9 = 9 }
: } ----- like "LUNIT1"
LUNIT15=15 }

If any of these usages are illegal or inconvenient at the installation of interest, alternate assignments should be made within module "SYSDEP" (see above chart). PRIME is one such system, for which some re-assignments had to be made. Actually, as of April, 1980, I do not believe that "LUNIT10" through "LUNIT16" are actually being used for anything other than possibly the "HAUER SETUP" code of overlays 48 and 49.

6. Use of OPEN/CLOSE statements to manage disk files

Most new compilers allow internal (within FORTRAN code) disk file connection and disconnection via OPEN and CLOSE statements. Yet the details differ from machine to machine, so all such usage is confined to installation-dependent EMTP modules. The following is an explanation of this usage by functional classification (feature by feature). The VAX modules, which presently occupy positions in the UTPF, are used for purposes of illustration.

A. LUNIT4 file of raw plot data points (SYSDEP, KATALOG, PFATCH)

The integer miscellaneous data card (Section 1.0h) defines variable ICAT which indicates whether or not the user wants to save the the raw plot data points on LUNIT4 once all EMTP processing of a data case is complete. Variables ICAT and LUNIT4 are in deck BLKCOM, so the construct "INSERT DECK BLKCOM" will make them available in any modules which might be written.

VAX is typical of most computer systems which require that a file be opened before it is written on. For this reason, OPENING of the LUNIT4 files is done within "SYSDEP" of overlay one, even though variable ICAT is not known that early. After the determination of the date and the time, we build a legal file name using these, and OPEN the file under the assumption that it will be saved:

```
CALL DATE44 ( DATE1(1) )
CALL TIME44 ( TCLOCK(1) )
  < < Build legal VAX/VMS file name using the digits
        of DATE1 and TCLOCK; put result in FILE25 > >
OPEN (UNIT=LUNIT4, TYPE='NEW', NAME=FILE25,
      1  FORM='UNFORMATTED')
```

The TYPE='NEW' specification indicates that we are to create another (a new) disk file, as opposed to the connection of an existing file. In building file name FILE25, remember that DATE1(2) and TCLOCK(2) are ALPHANUMERIC vectors of /BLANK/ ---- REAL*8 for IBM, VAX, PRIME, SEL, etc.; INTEGER for Burroughs, Univac, CDC; REAL*6 for Harris, etc. But before such OPENING of a new file, we ask whether the plot file of the preceding solution really was to be saved permanently; if so, it is saved; if not, it is deleted. Thus, at the top of "SYSDEP" (before the just-listed code) one sees:

```
IF (ICAT .EQ. 0) GO TO 120
IF (ICAT .GT. 2) GO TO 120
100 CLOSE (UNIT=LUNIT4, DISPOSE='SAVE')
GO TO 140
120 CLOSE (UNIT=LUNIT4, DISPOSE='DELETE')
140 CONTINUE
```

Here the ICAT which is being used is left over from the preceding solution, note (no EMTP data of the upcoming case has yet been read).

The use of FORM='UNFORMATTED' deserves mention. All WRITES to LUNIT4 will be binary (unformatted), and this declaration in the OPEN statement merely reflects that nature. Most computer systems do not make such a distinction between FORMATTED and UNFORMATTED I/O (VAX was the first we had heard of), fortunately, so the user can ignore this detail. For LUNIT4 this is no special complication, since I can not recall an other FORMATTED use of the same channel. But for other I/O units, different EMTP features can use different modes, and OPENING and CLOSEing has become conditional on /BLANK/ variables (but that need not concern us here).

One use for previously-saved LUNIT4 plot files is batch-mode EMTF plotting at some late time via a "REPLOT" request (see Section 1.0d of the Rule Book). The disk file in question is connected by a call to installation-dependent "PFATCH" (mnemonically, "permanent file attach") which is found in "REQUES" :

```

M28.1295C      $$$$$ SPECIAL-REQUEST WORD NO. 4.  'REPLOT'
M28.1296 8004 IF ( NOUTPR .EQ. 0 )
M28.1297      1 WRITE (LUNIT6, 3364)
M28.1298 3364 FORMAT ( 34H+REQUEST TO RE-PLOT OLD PLOT DATA. )
M28.1299      DEGMAX = 0.0
M28.1300      IALTER = LUNIT4
M28.1301      CALL MIDOV1
M28.1302      CALL PFATCH
M28.1303      NCHAIN = 31
M28.1304      GO TO 5617

```

The I/O unit number of the connection is carried through variable IALTER of /BLANK/, and that jump to S.N. 5617 provides a transfer to overlay NCHAIN = 31 plotting. As for "PFATCH", the rules associated with extracting the requested file from the remainder of the "REPLOT" data card are quite arbitrary and discretionary. For VAX, we chose to be quite restrictive, for simplicity. We require that a "REPLOT" data card use EMTF free-format (with a comma after the key word "REPLOT", in column 7), followed by the legal VAX/VMS disk file name. In this way, there is no character checking (e.g., to discard any "/" or "." which are shown in the illustration of Section 1.0d) or file-name building; we simply use the supplied name. Imbedded blanks are ignored (one minor sophistication; see check of TEXCOL(K) against BLANK), and the search for characters of the name is terminated when the free-field separator character CSEPAR is found. The search begins in column position KOLBEG, which is one column to the right of the last comma (in this case, the comma which followed "REPLOT", in column 7). ENCODE is used to transfer characters from the input card buffer TEXCOL(80) to our file name FILEN(25) because of the type difference ---- TEXCOL is ALPHANUMERIC (REAL*8 for VAX), while FILEN is a byte vector (INTEGER*1). After connection of the desired plot file, ICAT = 2 is set so that our precious disk file will be retained (rather than be destroyed) at the start of the following case (see previous "SYSDEP" logic).

```

5610      SUBROUTINE PFATCH
M27. 634      INSERT DECK BLKCOM
M27. 635      BYTE FILEN(25)
M27. 636      N4 = 0
M27. 637      ENCODE (25, 4523, FILEN(1))
M27. 638 4523 FORMAT ( 25X )
M27. 639      DO 4532 K=KOLBEG, 80
M27. 640      IF ( TEXCOL(K) .EQ. BLANK ) GO TO 4532
M27. 641      IF ( TEXCOL(K) .EQ. CSEPAR ) GO TO 4536
M27. 642      N4 = N4 + 1
M27. 643      ENCODE (1, 3041, FILEN(N4)) TEXCOL(K)
M27. 644 3041 FORMAT ( 80A1 )
M27. 645 4532 CONTINUE
5636      CLOSE (UNIT=IALTER)
OPEN (UNIT=IALTER, TYPE='OLD', FORM='UNFORMATTED',
M27. 652      1 NAME=FILEN)
M28.2834      ICAT = 2
5653      RETURN
5654      END

```

For those systems which can save files permanently after they have been written as scratch files, a cleaner alternative exists. This goes back to our BPA CDC usage, where all such LUNIT4 considerations were relegated to "KATALG" of overlay 20. No more writing on unit LUNIT4 will occur once overlay 20 is reached (normally by exit of the time-step loop of overlay 16, but possibly from overlay 12 if a TACS stand-alone case is involved). Further, there is now a call within "OVER20", though it also provides service for EMTP table saving (if integer miscellaneous data parameter MEMSAV is positive):

```
M28.6577 8005 IF ( ICAT .GT. 0 .OR. MEMSAV .GT. 0 )
M22.5384 1 CALL KATALG
```

Hence an installation-dependent "KATALG" must have /BLANK/ in it (via "INSERT DECK BLKCOM"), and a check to see whether this really does concern the plot file (ICAT positive) is necessary. The date and time are still available at this point, and are stored in the same vectors DATE1(2) and TCLOCK(2) as was illustrated for "SYSDEP". One final warning might be in order, however: although the EMTP is done writing on the LUNIT4 file by the time "KATALG" is reached, this does not mean that the file can be disconnected, since it might be read as part of the batch-mode EMTP plotting (CalComp EMTP plotting, or printer plots) of overlay 31. Thus actual disconnection must be delayed longer, and would normally be provided at the top of "SYSDEP" (as the following data case begins in overlay 1).

Concerning plot file naming, it is recommended that the date and the time (DATE1, TCLOCK) be used, since this will then allow easy association of the plot file with line printer output (which has this date and time buried in the heading). But beyond that, there should be some easy way to access all EMTP plot files as a group ---- possibly for audit purposes, possibly for copying to tape, possibly for deletion. For the VAX, we have seized upon file type for this special characterization (".PL4"). Thus, if any user wants a list of his plot files, he just issues the wild-card command "\$DIR *.PL4"; if he wants to delete all such files, he uses "\$DEL *.PL4;*"; etc. Our file names are slightly limited by the VAX restriction to 9 characters, however: we use a hexadecimal digit for the month, two decimal digits for the day, and six decimal digits for the time (24 hour clock). If the user's system allows longer names, more elaborate and precise names for the LUNIT4 disk files are probably desirable.

To complete this treatment of the EMTP plot file, there might be an indication of what is actually written to LUNIT4. This is fully documented in Section 5.0C (page 86a onward) of the EMTP Rule Book, so nothing more need be said here.

B. Check point capability (MEMSAV=1 and "START AGAIN")

For most users, the second most important extension (after the LUNIT4 plot manipulations just described) has to do with honoring the MEMSAV field (columns 59-56) of the miscellaneous data card. See Section 1.0h, page 4h of the Sept 1980 Rule Book. This provides for the dumping of EMTP tables onto disk for preservation as a permanent disk file. If at some later time the user wants to restart the simulation, using the identical same EMTP version (warning: dimensions must not have been altered), then "START AGAIN" of Section 1.0e15 is used.

Consider the saving of EMTF tables (MEMSAV = 1) first. This is done within "KATALOG" of overlay 20, for which the call is as follows (as previously displayed in Section A):

```
M28.6577 8005 IF ( ICAT .GT. 0 .OR. MEMSAV .GT. 0 )
M22.5384 1 CALL KATALOG
```

As for the file OPENing and CLOSEing within "KATALOG", it will depend in large part upon how sophisticated a naming procedure is desired. In the VAX case, we decided to use a fixed, pre-specified name TPTABLES.BIN, which simplified things. The operating system VAX/VMS would simply create a higher version if MEMSAV = 1 were used more than once by the user (no problem), and it is the user's responsibility to specify the correct set of tables during a subsequent "START AGAIN" request. Anyway, as for the critical block of code within "KATALOG", VAX uses the following:

```
M30.1048 2469 WRITE (LUNIT6, 2472)
M28.6606 2472 FORMAT ( /, 20X, '----- "MEMSAV = 1 REPRESENTS',
M28.6607 1 ' REQUEST FOR TABLE DUMPING ON DISK.' )
M28.6608 CLOSE ( UNIT=LUNIT2 )
M28.6609 OPEN ( UNIT=LUNIT2, TYPE='NEW', FORM='UNFORMATTED',
M28.6610 1 NAME='TPTABLES.BIN' )
M28.6611 CALL TABLES
M28.6612 CLOSE ( UNIT=LUNIT2, DISP='SAVE' )
2482 WRITE (LUNIT6, 2483) LTLABL
M28.6614 2483 FORMAT ( 26X, 'SUCCESSFUL SAVING OF EMTF',
M28.6615 1 ' TABLES AS FILE "TPTABLES.BIN" .',
M28.6616 2 ' LTLABL =', I8 )
```

Note that part of the table-dumping message (S.N. 2472) is printed before the dumping actually begins (it is done by "TABLES"), and the remainder occurs upon completion (S.N. 2482). This is mainly for interactive use, to placate the impatient user who may be watching such output on the screen (and wondering why there is a delay, during the dumping). Note that binary (UNFORMATTED) usage of I/O channel LUNIT2 is involved. Remember to put /BLANK/ in the module (INSERT DECK BLKCOM), since this carries LUNIT2 and LTLABL. Also, remember that if the plot file is also to be saved in "KATALOG" rather than in "SYSDEP" (see preceding section), then both ICAT and MEMSAV must be checked inside the module to see which (or both) of the functions is actually to be performed.

Later use of these EMTF tables is via the "START AGAIN" data card of Section 1.0e15. Installation-dependent aspects for VAX are very similar to "RELOT" as described in the previous section. Both features use "PFATCH" to actually connect the old disk file to I/O unit IALTER, though here unit LUNIT2 is employed as shown by the following universal code in "OVER1":

```
M22.1329C $$$$ SPECIAL-REQUEST WORD NO. 15. 'START AGAIN'
M22.1330 8015 IALTER = LUNIT2
M28. 818 IF ( NOUTPR .EQ. 0 )
M28. 819 1 WRITE (LUNIT6, 2857)
M28. 820 2857 FORMAT ( 40H+CONTINUE PARTIALLY-COMPLETED DATA CASE. )
CALL RUNTYM ( D1, D2 )
M22.1331 CALL PFATCH
M28. 822 CALL TABLES
M28. 823 FLSTAT(1) = -D1
M28. 824 FLSTAT(2) = -D2
M28. 825 IF ( LSTAT(16) .EQ. LTLABL ) GO TO 2863
M22.1338 KILL = 201
M22.1339 LSTAT(19) = 2856
M22.1341 GO TO 9200
M28. 826 2863 CONTINUE
```

Provided "PFATCH" was coded as described in Section A (for plot file usage), nothing else need be done here. Note the check on total table size (LSTAT(16) is the table size of the disk file, as carried out through this /BLANK/ variable, while LTLABL is the total table size of the present program version (from "DIMENS"). Only if these two agree (a necessary but not sufficient check for compatibility) is execution allowed to continue. Otherwise, a KILL = 201 error stop results.

User's of "START AGAIN" should be warned that batch mode EMTF plotting will be possible for the restarted case only if special effort is made. The interactive CRT plotting program "TPPLOT" can plot such results without difficulty. But if the user insists on EMTF batch-mode plotting, then put an extraneous "4" in column 13 of the "START AGAIN" card (after the comma, before the file name), and previously connect the old plot file to unit LUNIT4 somehow (IBM can do it via JCL; we on the VAX use \$OLDFILE of "CIMAGE" as described under Point 16 on page x-j8a of the Rule Book). See also Section D below (for "CIMAGE" \$-card enhancement).

C. Use of "TABULATE ENERGIZATION RESULTS" (STATSV, STATRS, MIDOV1)

Only the sophisticated "STATISTICS" user will have interest in the extensions of this section or the user of a computer which crashes a lot! Monte Carlo studies, where the same basic problem is solved over and over (with only switch closing or opening times altered between simulations, by the rolling of dice), are the only studies which are affected. By means of the extensions now to be detailed, such Monte Carlo studies can be solved in several smaller pieces, rather than one big one. If the computer crashes during such a simulation, it is like dropping a basket with eggs in it. The prudent, conservative strategy for anyone who drops eggs from time to time is to never carry too big a basket!

In terms of Rule Book data structures, we have "STATISTICS OUTPUT SALVAGE" of Section 1.0e7 (page 4b-5), and "TABULATE ENERGIZATION RESULTS" of Section 1.0e6 (page 4b-4). An EMTF support person considering such enhancement should read these two sections thoroughly before continuing.

The VAX installation-dependent logic associated with "STATISTICS OUTPUT SALVAGE" is confined to "MIDOV1" of overlay 1. Before this module is called by "OVER1", some universal preparation is performed, to be carried into "MIDOV1" via /BLANK/ :

```

M23. 415      N12 = JFLSOS / 100
M23. 416      N15 = JFLSOS - 100*N12
M23. 417      N13 = N15 / 10
M23. 418      N14 = N15 - 10*N13
M23. 419      LSTAT(14) = N12
M23. 420      LSTAT(15) = N13
M23. 421      LSTAT(16) = N14
M22.1558     CALL MIDOV1

```

That user-supplied sequence number JFLSOS (columns 30-32) is here broken down into three decimal digits which are carried into "MIDOV1" via the LSTAT vector. Disk file names are then built from these characters, and files are opened, as follows (within "MIDOV1"):

```

M29.1170 1815 IF (JFLSOS .EQ. 0) GO TO 4271
M24. 460   IF (LASTOV .EQ. 20) GO TO 5923

```

```

M24. 461      CLOSE (UNIT=3)
M24. 462      CLOSE (UNIT=9)
M24. 463      N4 = 3
M24. 464 5910 ENCODE (14, 5914, FILNAM(1) )N4, (LSTAT(J), J=14,16)
M24. 465 5914 FORMAT (2HST, 1I, 3HLOG, 3I1, 5H.DAT )
M24. 466      DO 4256 J=15, 20
M24. 467 4256 FILNAM(J) = C1
M24. 468      OPEN (UNIT=N4,TYPE='NEW',NAME=FILN20,FORM='UNFORMATTED')
M24. 469      IF (N4 .EQ. 9 ) GO TO 5923
M24. 470      N4 = 9
M24. 471      GO TO 5910
M24. 472 5923 RETURN

```

The VAX/VMS file name ST3LOG???.DAT is built on the first pass (for unit 3), and ST9LOG???.DAT is built on the second pass (for unit 9), where "???" is used to denote the three non-blank digits of the user-supplied serialization JFLSOS. The INTEGER*1 vector FILNAM(20) is equivalenced to the CHARACTER*20 name FILN20 which is actually used in the OPEN statement. This is all done before anything is written on units 3 or 9.

As for the information which is written to these two files, we have LUNIT3 written to by "OVER12" of overlay 12,

```

M17. 601      WRITE (LUNIT3) (KHIGH(I), KLOW(I), AKEY(I), TSTAT(I), ...
M23.2046      1 KDEPSW(I), I=1, KSWTCH), KLOAEP

```

and LUNIT9 written to by "OVER20" of overlay 20:

```

M13.2797      KNT = KNT + 1
M23.5347      IF ( KNT .EQ. 2 .OR.
M23.5348      1 IABS(NENERG) .EQ. 1 )
M23.5349      2 WRITE(LUNIT9) NSTAT, KSWTCH, NUMNVO, NC
M23.5350      WRITE (LUNIT9) ( XMAX(L), L=1, NSTAT )

```

This is done once each energization. In addition to information about the switches, LUNIT3 contains the crucial switch-closing times. On the other hand, LUNIT9 contains the peak overvoltage vectors which are to be statistically tabulated (NSTAT is the number of statistical output variables). KNT keeps track of energization number, and the exceptional additional dump for KNT = 1 is for header information, to be written only after the first energization.

For BPA CDC implementation (prior to our switch to the VAX in February of 1979), we were able to name the file after writing on it. This had the added flexibility of allowing for "STATISTICS" recovery even after operating system interrupts, from which we would also recover, and send control to the EMTP error overlays. So, in such cases, one can use "STATSV" (mnemonically, "statistics save") of overlay 55 rather than "MIDOV1" of overlay 1. But for the VAX and most computers, "STATSV" remains a dummy, unused module:

```

M23.6518      SUBROUTINE STATSV
M23.6567      RETURN
M23.6568      END

```

So much for the Monte Carlo EMTP solutions per se. Now on to the combination and statistical tabulation, as requested by "TABULATE ENERGIIZATION RESULTS". Universal aspects of this request are found in "SUBR29" of overlay 29, where the data cards specifying the files are read, and where each characteristic serialization (JF1, JF2, etc.) is decoded into three decimal digits which are stored in LSTAT(14) through LSTAT(16). In a loop over the different serializations, there are two calls to "STATRS", with interface variables all communicated via /BLANK/ .####The non-obvious ones are:

LSTAT(13) = 3, 9, or 0, depending upon whether it is the file ST3LOG???, ST9LOG???, or nothing which is to be connected to LUNIT1 next. In the zero case, we CLOSE LUNIT1.

LSTAT(14) = first decimal digit of "???" at end of file name;
 LSTAT(15) = 2nd decimal digit of "???" at end of file name;
 LSTAT(16) = last decimal digit of "???" at end of file name;

Once this communication is understood, and that /BLANK/ is present in module "STATRS", the code of "STATRS" should be self-explanatory by analogy to the previously-treated "STATSV". The VAX module "STATRS" has the following key statements:

```

      ENCODE (14, 1804, FILNAM(1)) ( LSTAT(I), I=13, 16 )
1804 FORMAT ( 2HST, I1, 3HLOG, 3I1, 5H.DAT )
      DO 4256 J = 15, 20
4256 FILNAM(J) = C1
      CLOSE (UNIT=LUNIT1)
      IF ( LSTAT(13) .EQ. 0 ) GO TO 9000
      IF ( IPRSUP .GE. 1 )
1 WRITE (LUNIT6, 1808) FILNAM
1808 FORMAT ( ' IN "STATRS", B4 OPEN OF UNIT LUNIT1 .', 20A1)
      OPEN ( UNIT=LUNIT1, TYPE='OLD', NAME=FILN20,
1 FORM='UNFORMATTED' )
      WRITE (LUNIT6, 1822) LSTAT(13), FILNAM
1822 FORMAT ( 20X,
1 '---- SUCCESSFUL OPEN OF LUNIT', I1, ' DATA',
2 ' ON DISK. PERMANENT FILE NAME = ', 20A1, 2H . )
9000 RETURN
      END
  
```

D. Installation-dependent \$-card capabilities (CIMAGE)

"\$-cards" are introduced in Section 1.D of the Rule Book (page 3b), so it is assumed that the reader has studied this universal material before going any further. All \$-cards are recognized and acted upon locally in module "CIMAGE" ---- even the universal ones. In this sense, the universal \$-cards are only universal in that their implementation is possible for any computer; it does not imply that the keeper of installation-dependent modules has actually done so. But most likely such code does already exist, and in this present section we are merely interested in further enhancing \$-card capability to include those installation-dependent commands which require file OPENing or CLOSEing.

The VAX "CIMAGE" module is large, but the reader should not be frightened. Most of the code will work for any computer system. It is only the ENCODE/DECODE and OPEN/CLOSE usage which might require conversion. Further, it is assumed that the reader has ENCODE/DECODE or its equivalence (e.g., Burroughs READ/WRITE involving memory), so only the OPEN/CLOSE portions need here be treated. This shall be done in order, from top to bottom of "CIMAGE".

We begin with:

```

M27. 183C          ***** REQUEST NO. 2.   "$PUNCH"          *****
which turns out to be universal if the LUNIT7 I/O channel is the
closest thing to a card punch which is available! But for those who
have a real physical card punch which is not connected to unit 7, and
for those who really want $PUNCH to punch physical cards, then
  
```

they can convert the "WRITE (LUNIT7" statement to "PUNCH" or whatever other command is appropriate. But cards are rapidly disappearing, and \$PUNCH is so little used anyway that such modification is not generally recommended.

Next comes:

```
M27. 211C          ***** REQUEST NO 4.   "$SAVE"          *****
which contains three file OPEN/CLOSE operations:
M27. 214 4423 CLOSE ( UNIT=N7, DISPOSE='DELETE' )
M27. 215          OPEN ( UNIT=N7, TYPE='NEW', FORM='FORMATTED'  NAME=FILEN )
M27. 220 4436 CLOSE ( UNIT=N7, DISPOSE='SAVE' )
These must of course be converted. The file name is stored in vector
FILEN, as extracted by the logic of $INCLUDE immediately below.
```

Next comes

```
M36. 217C          ***** REQUEST NO. 5.   "$SPYDATA"        *****
```

Assuming EMTP free format usage with commas (which is both easiest and most common), the "\$SPYDATA" is to be followed by a file name, followed by one integer for the I/O unit number which can be used for the file connection. Details of the file name will vary from system to system, of course. Anyway, the characters can be found by searching (TEXCOL(K), K=KOLBEG, 80). The VAX logic ignores blanks, and will truncate the name whenever a comma (CSEPAR) or parenthesis is found:

```
M27. 228          DO 4532 K=KOLBEG, 80
M27. 229          IF ( TEXCOL(K) .EQ. BLANK ) GO TO 4532
M27. 230          IF ( TEXCOL(K) .EQ. CSEPAR ) GO TO 4536
M29. 247          IF ( TEXCOL(K) .EQ. 1H( ) GO TO 4536
M27. 231          N4 = N4 + 1
M27. 232          ENCODE (1, 3041, FILEN(N4)) TEXCOL(K)
M27. 233 4532 CONTINUE
```

Here the file name is built into INTEGER*1 working vector FILEN(25). The only remaining installation-dependent records are the subsequent OPEN and CLOSE operations which follow:

```
M27. 259          CLOSE (UNIT=N7)
M36. 252          OPEN (UNIT=N7, STATUS='OLD', FORM='FORMATTED', FILE=FILEN )
```

Next comes:

```
M27. 276C          ***** REQUEST NO. 8.   "$RETURN"         *****
```

which has the single installation-dependent record which follows associated with it:

```
M27. 279 4817 CLOSE (UNIT=N1)
```

This represents a disconnection of whatever disk file may have been connected to I/O unit number N1. It "undoes" what \$ATTACH or \$NEWFILE did (the connection operation) when they were previously executed.

Next comes:

```
M27. 284C          ***** REQUEST NO. 9.   "$NEWFILE"        *****
```

which really is no different that \$ATTACH except that VAX/VMS makes a distinction between FORMATTED and UNFORMATTED usage; \$ATTACH is for FORMATTED usage, while \$NEWFILE is for UNFORMATTED. In any case, there is just one installation-dependent record, which should be self-explanatory:

```
M28. 169 4907 OPEN (UNIT=N7, TYPE='NEW', FORM='UNFORMATTED', NAME=FILEN )
```

Next comes:

```

M27. 298C          ***** REQUEST NO. 11.  "DELETE"          *****
which uses the following self-explanatory records which are
installation-dependent:
M27. 301 5106 OPEN ( UNIT=N7, TYPE='OLD', NAME=FILEN )
M27. 302          CLOSE( UNIT=N7, DISPOSE='DELETE' )

```

Next comes:

```

M28. 178C          ***** REQUEST NO. 16.  "OLDFILE"          *****
which contains the following installation-dependent records:
M28. 182 5608 CLOSE (UNIT=N7)
M28. 183          OPEN (UNIT=N7, TYPE='OLD', FORM='UNFORMATTED', NAME=FILEN )

```

So much for file operations of "CIMAGE". Although certainly no conversion problem, I might also mention other minor conversion details for some systems. In several places there will be found explicitly-counted Hollerith strings on the right hand sides of equal signs, such as the following of \$ATTACH:

```

M27. 181 4100 TEXT1 = 6HATTACH
This could be easily made universal, but I like the self-explanatory
aspect of having the character string present, so no change is now
contemplated. Also, there is $MONITOR, which directly writes to
the line printer (whether or not there is a LUNIT6 connection):
M29. 295          PRINT 3006, BUFF10
M27. 307          PRINT 5214, NUMDCD
M27. 308 5214 FORMAT ( '+CRT MONITOR. CARD NUMBER =', I5 )

```

Systems which do not have such direct printing will just have to comment out this operation.

Section 0.5aFormer Program Versions That Are No Longer Being Listed

Previous versions of the Rule Book had a page for just about every different computer that had been seriously considered for support of the EMTP, beginning with this section. But this policy is being abandoned in 1986. The last such complete listing, then, is in the "M39." manual dated June, 1984.

In order to save paper, and also to minimize potential bother to those whose names were once listed, program versions that are not known to be active today have been downgraded to an inconspicuous and sometimes indefinite mention in the list that follows. Even if usage is known to continue, there is no listing if no active, cooperative contact is known to exist for current program versions.

For those individual entries that have been removed as separate pages, a few summary details will be provided. For more details, consult older user documentation.

1) CDC as listed before was the old, 60-bit, overlaid machinery that could only address with 18 bits. Support ended when Prof. Mohan of the University of Minnesota shifted his EMTP usage to Apollo in early 1984. With all-new, fully-virtual CDC machinery now being sold, it is doubted whether EMTP usage of the old CDC hardware has much if any EMTP future. It is hoped that an EMTP version for the new CDC will come from Prof. Hian Lauw of Oregon State University in Corvallis, Oregon, eventually. Such a machine was installed in the EE Department during September of 1985. Yet timing is unclear, since such work is not a priority for those in Corvallis. Also, with the acquisition of half a dozen powerful, new, 32-bit Apollo DN3000 nodes, it is conceivable that EMTP interest in the new CDC might even disappear entirely. Yet we hope not.

2) Univac 1100-series machines were non-virtual, 36-bit word machines that used overlaying to handle the EMTP. Active support from Ontario Hydro (Toronto, Ontario, Canada) seemed to end shortly after that utility acquired a DEC VAX-11/780, and began using VAX for its EMTP studies. That was during 1981 or 1982, it is estimated. The most recent Univac EMTP version that was known to be distributed was of "M31." vintage. While Univac certainly had no trouble supporting the EMTP, users seemed to prefer the operational convenience and improved economics of smaller alternatives to such mainframes.

3) Honeywell mainframes once were supported in grand style by Bob Newell of Basin Electric Power Cooperative (see the current Prime Computer page). But this Honeywell support ended when Basin Electric acquired PRIME and PTI PSS/E software for it. After a lapse in Honeywell EMTP availability of perhaps two years, Bob Jones of Southern Company Services in Birmingham, Alabama, switched to an existing Honeywell machine for EMTP support, but this only lasted a year or two. Honeywell EMTP support in Birmingham ended in 1986 with the acquisition of Apollo. While Honeywell seemed to have no trouble supporting the EMTP, users seemed to prefer the operational convenience and improved economics of smaller alternatives to such mainframes.

4) Harris once was used by the University of Wisconsin at Madison for EMTP support during the annual summer EMTP short course. But such usage was switched first to VAX, and more recently to Apollo. It is doubtful whether any known owner of Harris hardware is serious enough about the EMTP to maintain proven compatibility in the future. Yet it should be emphasized that there were no fundamental drawbacks or problems with the newer hardware, which does indexing with 20 bits (the earlier machines with 18-bit indexing were hard pressed to cope with the expanding EMTP).

5) Telefunken TR-440 EMTP compatibility was confirmed during 1980, when the report of generally successful "M19." experimentation finally reached BPA from AEG-Telefunken of Frankfurt, West Germany. But the TR 440 was never a commercial success, and AEG-Telefunken interest in the EMTP was somewhat casual. No second party with Telefunken EMTP interest has ever been identified, and no newer Telefunken EMTP work is known.

6) Floating Point Systems FPS-164 Attached Processor compatibility with the "M32." EMTP was demonstrated late in 1982. But cost effectiveness and convenience were less than clear. Testing by BPA was done with the factory in Beaverton (a suburb of Portland, Oregon), so no production user with EMTP interest was ever located.

7) DEC PDP-10 and System 20 are machines for which the story parallels those preceding stories of Univac and Honeywell. So does the hardware: 36-bit word machines. Yes, some usage remains today, but the days of such usage are clearly numbered, because the manufacturer has announced its intention to discontinue word machines and concentrate on the more modern, byte-organized VAX-11 line. The newest version known to be operating is a true "M39." version that is still being used by Prof. Hian Lauw of Oregon State University in Corvallis, Oregon. Interactive CRT plotting has been connected, too. But how long such support will continue is speculative (my guess is that use of the 2020 in Corvallis for support of the EMTP will end when Apollos begin arriving in quantity).

8) Cray supercomputers certainly are capable of EMTP support, and an "M31.+" version was set up and tested at Lawrence Livermore Laboratory (LLL) in Livermore, California, by Dr. Walter G. Magnuson, Jr. Is LLL still using the Cray EMTP? Are the economics and convenience (or possible inconvenience) of such a super computer really desirable for EMTP use? There are more questions than answers about the Cray EMTP.

9) Burroughs mainframes are certainly capable of support of the EMTP, but much as with Univac, Honeywell, and DEC PDP-10, such usage has been eroded in recent years by the switch to smaller, more convenient alternatives. Our last good contact was Ebasco Services Incorporated of New York City. But when Stoney McMurray left Ebasco during 1985, the Burroughs EMTP contact ceased. It is believed that all Ebasco EMTP usage has shifted to DEC VAX. The testing of the Burroughs EMTP is so tricky that it is doubted whether any future version will ever be fully tested and generally available.

10) MODCOMP was used for a time by EPSRI of Peking, China, for support of the EMTP. But the "Classic" model then available was really a control computer, and it had several drawbacks for EMTP usage, including limitations on memory addressing, unbelievably slow compilation and linkage editing, and lack of virtual memory management. It was decided to shift EMTP usage to other, better-suited machinery during 1983.

11) ICL was used to support an "M31." version of the EMTP by The University in Glasgow, Scotland. For those not familiar with the name, International Computers, Limited is the computer giant of the British empire. The hardware being used in Glasgow was very similar to an IBM mainframe, and it seemed obviously capable of handling the EMTP. Yet nothing has been heard from any ICL EMTP user for several years. If there is a problem, it would seem to be a lack of one dedicated industrial user who can produce and maintain current program versions for others around the world. All machines of interest are located a long way from Portland, unfortunately (none having EMTP interest are located in the Western hemisphere). The man most closely associated with ICL EMTP computer details back in 1983 was Dr. Paul Rosenberg of The Computing Service (the central computer installation).

12) Siemens is the "General Electric of West Germany," and the sale of computers that resembled IBM mainframes was a small portion of this giant company's business. Such a Siemens computer was used by FGH (Forschungs-Gemeinschaft fur Hochspannungs- und Hochstromtechnik E.V.) of Mannheim for support of the EMTP until 1985, when there was a shift to Apollo. Any questions about the future of the Siemens EMTP could best be directed to Dipl.-Ing. Bernd Stein of FGH, who once was in charge of producing and maintaining it.

13) NEC ACOS is a Japanese computer that once was used in two quite different forms for support of the EMTP. First, there was the non-virtual, 36-bit word machine that looked almost identical to Honeywell. This was used by Meidensha Electric Mfg. Co., Ltd., of Tokyo during late 1982. Second, there was the virtual, byte-organized ACOS computer of Nissin Electric Co., Ltd. of Kyoto. Nothing later than 1983 is known about either machine or its usage for support of the EMTP.

14) FACOM is another Japanese computer. In 1982 when EMTP work was under way, it looked a lot like an IBM mainframe with enhanced software. Work was done at Century Research Center Corporation of Osaka.

15) Hitachi HITAC is still another Japanese computer that resembled an IBM mainframe. It was used by the Kokubu Works of Hitachi, Ltd., for support of the EMTP during 1983, when we had extensive contact.

16) Perkin-Elmer was a manufacturer of powerful minicomputers during 1981 when "M28.+" EMTP materials were produced. But a cooperating user with EMTP interest was never found. We have here an EMTP versions that is looking for an owner and a home. On paper, Perkin-Elmer machines should be EMTP compatible, but FORTRAN was never tested (although it was produced).

NEC ACOS

FACOM

HITACHI

PERKIN-ELMER

The remainder of this IBM EMTP section shall be devoted to AEP documentation, which begins with a sample letter of response to an inquiry about the IBM EMTP. After that comes the printed documentation with which AEP supplies people, in responding to requests for the IBM EMTP. Inquiries should be made of :

Michael M. Price; Floor 7
Engineering Information Systems
Information Systems Department
American Electric Power Service Corp.
1 Riverside Plaza
P. O. Box 16631
Columbus, Ohio 43216-6631
Phone: (614) 223-3776

American Electric Power Service Corporation announces the availability of the M34+ version of the Electromagnetic Transients Program (EMTP) for the IBM computer. This program, developed under the auspices of the Bonneville Power Administration (BPA), has been set-up and tested on the IBM computer by AEP. As with previous versions of EMTP, AEP will supply the program, JCL, and installation documentation at no charge. However, due to the large number of tapes received, the problems in handling out-of-company tapes, and the unacceptable condition of many of the tapes (mislabeled, too short, physically broken during shipping, etc.), AEP has decided to supply the tapes and mailers for the program distribution.

To offset our costs for the tape purchase, preparation and mailing, the following fee schedule has been set:

- For all organizations within the USA, Canada, or Mexico:.....\$150.00
- For all organizations outside the USA, Canada, or Mexico:.....\$175.00

AEP's offer does not include the EMTP Rule Book. For a copy please contact Dr. Scott Meyer of BPA. His address is:

W. Scott Meyer, Rute EOGA
Bonneville Power Authority
P. O. Box 3621
Portland, Oregon 97208
Phone: (503) 230-4404

Through AEP's newly created subsidiary, AEP Energy Services, Inc., several EMTP-related services could be offered:

- Processing EMTP studies on our corporate computer for other organizations.
- Providing an EMTP installation service.
- Performing power system studies.
- Providing training in the use and/or internals (FORTRAN Source) of EMTP.
- Providing a user friendly preprocessor for EMTP data.

AEP
AEP
AEP
AEP
AEP
AEP
AEP

If you have an interest in obtaining the IBM version of EMTF or making use of the services mentioned above, please write to:

Michael M. Price
American Electric Power Service Corporation
1 Riverside Plaza - 7th Floor
Columbus, Ohio 43216-6631

For your convenience, an order form has been included. Please use a copy of this form as your invoice. If you have any questions, you may call Mike Price at (614)223-3776.

The AEP-created tape will be 6250 BPI, 9-track, 2400 foot, with a standard IBM label (non-label and/or 1600 BPI by special request). It will include all the JCL needed for installation and execution of EMTF (system dependent changes will need to be made), the FORTRAN source code, executable load modules, object modules, link editor data, and test case data. This version has been successfully compiled using the IBM "OS/360 FORTRAN H-extended Level 2.2 (Sept. 76)" compiler.

Sincerely yours,

STRUCTURE OF THE EMTF M34 TAPE

Your tape has been loaded with the following information to aid in the installation, testing, and execution of the EMTF.

<u>FILE#</u>	<u>CONTENTS</u>	<u># OF RECORDS</u>	<u>FORMAT</u>
1	Job Control Language	756	Sequential with IEBUPDTE control cards
2	FORTRAN Source, Link Editor Data, Test Case Data	107,587	Sequential with IEBUPDTE control cards
3	Executable Load Modules	---	Unloaded sequential
4	Object Modules - All Modules	---	Unloaded sequential
5	Object Modules - ll Modules for the "Big" Version	---	Unloaded sequential

Files 1 & 2 have the necessary control cards between each module to be used as input to the IBM utility program IEBUPDTE. By the use of IEBUPDTE, the partitioned dataset (PDS) can be reconstructed for the JCL & source. The JCL may be kept in a PDS where it can be submitted via TSO, or the sequential file may be punched to cards. In addition, global changes can be made to the sequential JCL and FORTRAN files, and then the PDS can be recreated via IEBUPDTE.

Files 3, 4, & 5 were created by unloading the load and object module PDS' via IEBCOPY. These files should be loaded onto your computer system using IEBCOPY. Note that these three files have been included as a time saving option since file one includes the JCL needed to recreate files 3, 4, & 5.

AEP
AEP
AEP
AEP
AEP
AEP
AEP

1) JCL

The following JCL is included in file one:

DUMPTAPE - used to dump the tape contents onto disk. As written, all files are stored in temporary disk files only. Any files required to be kept on disk can be renamed, supplied with a VOL # and its DISP changed to KEEP/CATLG.

If the files are going to be saved on disk, the following names will agree with those used in the other JCL modules on this tape:

<u>DATA DESCRIPTION</u>	<u>TEMPORARY NAME</u>	<u>SUGGESTED PERMANENT NAME</u>
Source Module PDS	&&SRCPDS	TST.TRAEMTP.FORT
Load Module PDS	&&LOADMODS	TST.TRA
Object Module PDS (all modules)	&&OBJMODS	TST.TRAEMTP.OBJ
Object Module PDS (Big Version)	&&OBJMODS2	S710828.EMTPBIG.OBJ

(NOTE: DUMPTAPE specifies "DEN=3" for 1600 BPI. This should be changed to "DEN=4" for 6250 BPI.)

- COMPILE - Used to compile all the FORTRAN modules. Note that this job has 336 steps which is greater than the maximum allowed on most systems. This was split into 7 jobs at AEP. The results of running these jobs have been included in file 4 of the tape.
- ASSEMBL - Used to assemble the three assembler modules (P0011013, P0011337, & P0011338). The results of running this JCL are also included in file 4 of the tape.
- LINKVARD - Used to link edit the variable dimensioning program (VARDIM). The linked VARDIM program (VARDIM34) has been included in file 3 of the tape.
- EXECVARD - Is used to run the variable dimensioning program (VARDIM) and save the 11 subroutines (P0011003, P0011041, P0011141, P0011148, P0011158, P0011173, P0011207, P0011211, P0011230, P0011245, P0011277) in the source PDS.
- M34LNKFS - Is used to link the fully overlaid "small" version of EMTF (TRAM34FS). This JCL uses the object modules stored in TST.TRAEMTP.OBJ. The link editor data used is TST.TRAEMTP.FORT(P0011).
- M34LNKFB - Is used to link the fully overlaid "big" version of EMTF (TRAM34FB). This JCL uses the object modules stored in TST.TRAEMTP.OBJ, but uses the 11 object modules stored in S710828.EMTPBIG.OBJ instead of the same named modules in TST.TRAEMTP.OBJ. The link editor data used is TST.TRAEMTP.FORT(P0011).

AEP
AEP
AEP
AEP
AEP
AEP
AEP

- M34LNKSS - Is used to link the semi-overlaid "small" version of EMTTP (TRAM34SS). This JCL uses the object modules stored in TST.TRAEMTP.OBJ. The link editor data used is TST.TRAEMTP.FORT(P0011A).
- RUNVARDS - Is used to run the VARDIM Program, store the 11 subroutines in TST.TRAEMTP.FORT, compile these routines, and store the object modules in TST.TRAEMTP.OBJ.
- RUNVARDB - Is used to run the VARDIM Program, store the 11 subroutines in a temporary dataset, compile these routines, and store the object modules in S710828.EMTPBIG.OBJ.
- EMTPRUN- Is used to execute the EMTTP.

2) FORTTRAN SOURCE PDS

File 2 of the tape has the contents of the FORTRAN PDS which includes 337 FORTRAN members, 3 Assembler members, 2 link editor data members, and 1 test case data member. The following list is an abbreviated, alphabetical listing of the 343 members from this file.

- P0011 - link editor data, fully overlaid
- P0011a - link editor data, semi-overlaid
- P0011000 - HEADER, subroutine for the IBM version only (see link editor JCL)
- P0011001 - FORTRAN and Assembler routines of EMTTP
to
P0011338
- TESTDATA - test case data (see microfiche of BPA's results)
- TRAIHOED- A FORTRAN program used to edit the output file to remove the underflow errors generated by the AEP supplied load modules. These messages should be suppressed, but due to an error in the setup of AEP's H-EXT compiler, an unlimited number of the messages will be printed out. Since this is just a warning message, the program answers are correctly calculated. If the user decides to recompile the EMTTP on their computer, this program and the supporting JCL may be removed.

3) LOAD MODULES

The following load modules are included in file 3 of the tape:

- VARDIM34 - is the load module of the variable dimensioning program VARDIM.
- TRAM34FB - is the fully overlaid "big" load module of the EMTTP allowing 603 busses.

AEP AEP AEP AEP AEP AEP AEP AEP

- TRAM34FS - is the fully overlaid "small" load module of EMTF. This module uses the default dimensions of the VARDIM Program (250 busses).
- TRAM34SS - is the semi-overlaid "small" load module of EMTF. This module uses the default dimensions of the VARDIM Program (250 busses).
- TRAIHOED - is the load module of the TRAIHOED described in the previous section.

4) OBJECT MODULES

The object modules in file 4 are the compiled version of the FORTRAN and assembler modules of file 2. The IBM "OS/360 FORTRAN H-extended level 2.2 (Sept.76)" compiler was used for all the FORTRAN modules. When the G-1 compiler was used, an IGI031I ROLL SIZE EXCEEDED error was produced for the routines with very large common areas.

The object modules in file 5 are the compiled VARDIM created sub-routines as created by the RUNVARDB JCL.

5) QUICK SETUP METHOD

Since the load modules have already been included, there is no need for the source and object modules to be unloaded from the tape (unless program or dimension changes are to be implemented). Listing 1 is the member DUMPTAPE from the JCL file. From this JCL, the sections needed can be extracted to get only the files you wanted on your system. Optionally, listing 2 can be used to punch the complete JCL file to cards, or an OS file, so that the DUMPTAPE JCL can be accessed with minimum typing on your part.

6) RESULTS OF TEST CASE RUNS

Most of the test cases supplied by BPA were made to run on the IBM version and produce comparable results with the BPA version. The following cases are the exceptions:

DC-29 & DC-63	Semlyen setup
DC-16	systematic study
DC-36	TRELEG study
DC-49	Start Again
DC-68	DC simulation
DC-40, 65, & Hauer setup	no longer supported by BPA

AEP AEP AEP AEP AEP AEP AEP AEP

- DC-47 type 59 machine with TACS. Note that other cases with tacs and the type 59 machine run.
- DCNEW-3, 5, & 6 will bomb while printing a listing of the cards that were punched to file unit 7. Since the cards are punched prior to the stopping of the program, and since the object of the study is to get those punched cards, this error is considered to be an inconvenience rather than a problem.
- DC-8, 24 will bomb if run on the fully overlaid version, but will run correctly on the semi-overlaid version.

LISTING 1: DUMPTAPE

```

//TRA JOB (1200,52,07MP,1,1,,1,,),'PRICE',MSGLEVEL=(1,1), 00000100
// REGION=256K,MSGCLASS=C,CLASS=C 00000200
/*SETUP TAPE 020400(0) 00000300
//GEN PROC 00000400
//P1 EXEC PGM=IEBGENER 00000500
//SYSIN DD DUMMY 00000600
//SYSPRINT DD SYSOUT=C 00000700
//SYSUT1 DD DSN=ADSNS,UNIT=(TAPE,,DEFER),VOL=REF=#.S1.ORIG, 00000800
// LABEL=(SNO.,SL),DISP=(OLD,PASS),DCB=DEB=# 00000900
//SYSUT2 DD DSN=ADSNS,DISP=(OLD,PASS) 00001000
// PEND 00001100
//S1 EXEC PGM=IEFBRI4 00001200
//SYSPRINT DD SYSOUT=C 00001300
//ORIG DD UNIT=(TAPE,,DEFER),DISP=(OLD,PASS),VOL=SER=020400 00001400
//JCLSEQ DD DSN=ADSNS,DISP=(,PASS),UNIT=DISK, 00001500
// SPACE=(TRK,(10,2)),DCB=(RECFM=FB,BLKSIZE=3200,LRECL=80) 00001600
//JCLPDS DD DSN=ADSNS,DISP=(,PASS),UNIT=DISK, 00001700
// SPACE=(TRK,(10,2,4)),DCB=#.JCLSEQ 00001800
//LOADPDS DD DSN=ADLADMODS,DISP=(,PASS),UNIT=DISK, 00001900
// SPACE=(TRK,(400,20,5)),DCB=(BLKSIZE=1024,RECFM=U) 00002000
//OBJPDS DD DSN=ADOBJMODS,DISP=(,PASS),UNIT=DISK, 00002100
// SPACE=(CYL,(10,1,40)),DCB=#.JCLSEQ 00002200
//OBJPDS2 DD DSN=ADOBJMODS2,DISP=(,PASS),UNIT=DISK, 00002300
// SPACE=(CYL,(1,1,1)),DCB=#.JCLSEQ 00002400
//SRCSEQ DD DSN=ADSOURCE,DISP=(,PASS),UNIT=DISK, 00002500
// SPACE=(CYL,(20,1)),DCB=#.JCLSEQ 00002600
//SRCPDS DD DSN=ADSRCPDS,DISP=(,PASS),UNIT=DISK, 00002700
// SPACE=(CYL,(20,1,40)),DCB=#.JCLSEQ 00002800
//GO1A EXEC GEN,DSN=JCL,NO=1 00002900
//GO1B EXEC PGM=IEBUPDTE,PARM=NEW 00003000
//SYSPRINT DD DUMMY 00003100
//SYSUT2 DD DSN=ADSNS,DISP=(OLD,PASS) 00003200
//SYSIN DD DSN=ADSNS,DISP=(OLD,PASS) 00003300
//* 00003400
//GO2 EXEC GEN,NO=2,DSN=SOURCE 00003500
//GO2B EXEC PGM=IEBUPDTE,PARM=NEW 00003600
//SYSPRINT DD DUMMY 00003700
//SYSUT2 DD DSN=ADSRCPDS,DISP=(OLD,PASS) 00003800
//SYSIN DD DSN=ADSOURCE,DISP=(OLD,PASS) 00003900
//* 00004000
//GO3 EXEC PGM=IEBCOPY,PARM='SIZE=100K' 00004100
//SYSPRINT DD SYSOUT=C,HOLD=YES 00004200
//INTAPE DD UNIT=(TAPE,,DEFER),LABEL=(3,SL), 00004300
// DISP=(OLD,PASS),VOL=REF=#.S1.ORIG,DCB=(RECFM=U, 00004400
// BLKSIZE=1024,DEB=#),DSN=LOADMODS 00004500
//OUTDISK DD DSN=ADLADMODS,DISP=(OLD,PASS) 00004600
//SYSUT3 DD UNIT=DISK,SPACE=(TRK,(1)) 00004700
//SYSUT4 DD UNIT=DISK,SPACE=(TRK,(1)) 00004800
//SYSIN DD * 00004900
COPY OUTDD=OUTDISK,INDD=INTAPE 00005000
//GO4 EXEC PGM=IEBCOPY,PARM='SIZE=100K' 00005100
//SYSPRINT DD SYSOUT=C 00005200
//SYSIN DD * 00005300
COPY OUTDD=OUTDISK,INDD=INTAPE 00005400
//OUTDISK DD DSN=ADOBJMODS,DISP=(OLD,PASS) 00005500

```

AERP AERP AERP AERP AERP AERP AERP AERP AERP AERP

```

//INTAPE DD UNIT=(TAPE,,DEFER),LABEL=(4,SL),          00005600
//          DISP=(OLD,PASS),VOL=REF=#.S1.ORIG,DCB=(RECFM=FB, 00005700
//          LRECL=80,BLKSIZE=3200,DEN=4,DSN=OBJMODS      00005800
//SYSUT3 DD DSN=##TEMP,UNIT=SYSDA,SPACE=(CYL,(7,1))    00005900
//GO5 EXEC PGM=IEBCOPY,PARM='SIZE=100K'                00006000
//SYSPRINT DD SYSOUT=C                                  00006100
//SYSIN DD *                                             00006200
COPY OUTDD=OUTDISK,INDD=INTAPE                          00006300
//OUTDISK DD DSN=##OBJMODS2,DISP=(OLD,PASS)            00006400
//INTAPE DD UNIT=(TAPE,,DEFER),LABEL=(5,SL),           00006500
//          DISP=(OLD,PASS),VOL=REF=#.S1.ORIG,DCB=(RECFM=FB, 00006600
//          LRECL=80,BLKSIZE=3200,DEN=4,DSN=OBJMODS2    00006700
//SYSUT3 DD DSN=##TEMP,UNIT=SYSDA,SPACE=(CYL,(7,1))    00006800

```

LISTING 2: JCL PUNCH

```

//GO1 EXEC PGM=IERGENER
//SYSPRINT DD SYSOUT=C
//SYSIN DD DUMMY
//SYSUT1 DD UNIT=TAPE,LABEL=(1,SL),DISP=OLD,DSN=JCL,
//          VOL=SER=XXXXXX,DCB=DEN=4
//SYSUT2 DD SYSOUT=F
-OR-
//SYSUT2 DD DSN=XXXXX,DISP=OLD

```

F64-LEVEL LINKAGE EDITOR OPTIONS SPECIFIED OVLY,TERM,LET,SIZE=(999K,24K)
VARIABLE OPTIONS USED - SIZE=(1022976,24576)

```

IEW0182 18 LAST14
IEW0182 31 WYLACE
IEW0182 32 READL5
IEW0182 32 READL5
IEW0182 32 READL5
IEW0182 32 READL5
IEW0132 OPENL5

```

****TRAM34FS DOES NOT EXIST BUT HAS BEEN ADDED TO DATA SET
AUTHORIZATION CODE IS 0.

does exist! The reference here is due to a CALL across overlay boundaries. Wdm

DIAGNOSTIC MESSAGE DIRECTORY

IEW0132 ERROR - SYMBOL PRINTED IS AN UNRESOLVED EXTERNAL REFERENCE.
IEW0182 ERROR - INVALID EXCLUSIVE CALL FROM SEGMENT NUMBER PRINTED TO SYMBOL PRINTED.

PLEASE NOTE:

*This is a normal link editor output.
The listed routines no longer exist
in the EMTP.*

AERP AERP AERP AERP AERP AERP AERP AERP

x-e

0.5e Data General MV/8000 EMTF Setup (by IIT, Madrid, Spain)



INSTITUTO DE INVESTIGACION TECNOLOGICA

During the spring and early summer of 1981, a translator was developed for the DG MV/8000 computer system. This is a fully-virtual, 32-bit minicomputer that should be capable of quality EMTF support. Our contact was one Ignacio J. Perez, a Spaniard who then seemed to be attending the Massachusetts Institute of Technology in Cambridge. Back home in Madrid, he told us, was to be a DG MV/8000, and the company in question had interest in electromagnetic transients. My letters to him dated 8 May 1981 and 8 June 1981 document such details, as well as translation principles.

Then we lost contact with Mr. Perez, who seemed to be preoccupied with other matters until May of 1985. No other party seriously interested in the DG MV/8000 EMTF version could be found in the interim. So no progress was made for almost 4 years.

In may of 1985, we learned that Mr. Perez is not only alive and well, but that he also is a very busy man with a responsible position. For the record:

Ignacio J. Perez-Arriaga, Director
Instituto de Investigacion Tecnologica (IIT)
Alberto Aguilera, 23
28015 Madrid
SPAIN

BPA complied with this second request for DC MV/8000 EMTF materials, which were mailed along with a cover letter dated 29 May 1985. A letter of response dated 4 November 1985 confirms that "the program is currently running in our computer."

The November 4th letter indicates that IIT has joined the Leuven EMTF Center, so other Europeans with Data General EMTF interest could also inquire through the Belgian channel. But for non-Europeans, write directly to Madrid for more information.

DATA GENERAL

DATA GENERAL

DATA GENERAL

**BASIN ELECTRIC
POWER COOPERATIVE**

1717 EAST INTERSTATE AVENUE
BISMARCK, NORTH DAKOTA 58501-9990
PHONE 701/223-0441



Program Startup

Assuming the user has performed the normal LOGIN procedure for his installation, execution of EMTF begins by typing in

EMTF

at command level.

This initiates a small program which in its turn starts the large segmented transients program. A short delay in program response will be experienced by the user during the initial setup. (This is due to the segmented loader paging the program out to disc.)

Execution

The program will request the names of four disc files for input, output, punching, and plotting. The input file must exist in the user's UFD, and all four names must be given regardless of the fact they may not all be used. If the user does not enter a filename as requested, but instead responds with only a carriage return, the program will use its own default names, these being,

EMTPIN

EMTPOT

EMTPW1

EMTPPL

respectively. After these file names have been entered, the program will begin processing the input data.

Upon successful execution of EMTF, the user's terminal will be returned to normal system command level.

Program Output

To print the output file, type ,

SPOOL output filename (F)

To obtain plots on an electrostatic plotter, type

SPOOL plot filename (R)

The individual at Basin Electric who is most closely associated with PRIME EMTF setup is ----->

Robert J. Newell, Supervisor
Power System Studies Division
Planning & Marketing Department

PRIME

PRIME

PRIME

PRIME

PRIME

Preceding versions of this section included summaries of unsuccessful attempts first with HP 3000 and later with HP 1000 minicomputers. There was always some combination of hardware or system software that prevented support of the EMTF using such early HP equipment. Today, we have forgotten about those difficult early times, and we concentrate just on the good news of more modern HP offerings, such as the HP 9000.

Consideration of the HP 9000 began with the cooperation of both Ms. Geri Georg of H-P in Fort Collins (Ref. 8, Vol. XIV, 21 November 1983, Section I-C, pages CAUS-3 through 7), and Dr. Olov Einarsson of ASEA Research in Sweden (Vol. XV, 19 January 1984, Section VI-B, pages AESS-43 through 47). During a brief period when ASEA support using HP was in question, Keith Adamson of Chas. T. Main in Boston came to the rescue. All three parties have done commendable work, and have freely shared it with others, making the HP 9000 EMTF the useful production tool that it is today.

HP 9000 was the first Unix machine to support the EMTF, so it has been important in this sense. With Unix rapidly becoming the standard for scientific workstations (it is expected that Apollo will discontinue Aegis in the not too distant future), there should be no question of future support and compatibility. One peculiarity of the HP implementation of Unix for the 9000 is that unprintable numbers will result in an error flag being set by output routines, and subsequent termination of execution. Most computer systems do not do this. Most (e.g., Apollo, CDC, or IBM) just print some special characters such as a string of stars, and continue with program execution without further protest. Some systems (e.g., VAX-11) will generate an error message, but thereafter, execution will continue. But not HP 9000. While the phenomenon is not serious for normal production studies, it can make the program unusable when DIAGNOSTIC printout (IPRSUP) is turned on. Program developers understand the problem, and have agreed to work on a solution as time permits. But it will take patience, and time.

Programs and data are exchanged among HP 9000 owners by the thoroughly modern medium of cartridge tape. I do not have any model numbers or specifications, but something on the order of 45 or 60 Mbytes of data can be stored in a single cartridge. No one else (i.e., a non-9000 owner) may be able to read the medium, but it certainly is ideal among those who are members of the HP 9000 club. Those wanting the HP 9000 EMTF should be prepared to mail such a cartridge to the supplier.

Those outside North America are referred to Europe for a version of the HP 9000 EMTF. It is believed that an "M39." or "M39.+" is currently being used. The individual most closely associated with support of the HP 9000 EMTF is:

Dr. Olov Einarsson
ASEA, Department KZEB
S-72183 Vasteras
SWEDEN

Dr. Einarsson has been a model of cooperation in his HP 9000 EMTF support, requiring only that the interested party agree to share the materials freely with others as ASEA shares those materials with him. As for requests from North America, it probably is easiest to telephone BPA for a recommendation.

H-P
H-P
H-P
H-P
H-P
H-P

0.5j DEC VAX EMTP Setup (as used at BPA in Portland)A. Background of BPA VAX EMTP

The VAX-11/780 (as well as the newer and weaker VAX-11/750, VAX-11/730, and MicroVAX models) is a fully-virtual 32-bit minicomputer of the Digital Equipment Corporation (Digital; DEC). The factory-supplied operating system is known as VAX/VMS. At BPA, all EMTP work was shifted from our CDC computers to a dedicated VAX-11/780 in February of 1979 (see Ref. 8, Vol. VIII, 19 November 1978, pagination ABBO). No customization of the software is required for support of the EMTP using VAX, except possibly by the operator who controls system parameters at start-up time. The EMTP is a very large virtual image, so if the "/DEBUG" option is used everywhere, around 16 megabytes of virtual address space are required (at one time, the factory-supplied default limit was between 4 and 5 megabytes). Inquiries by interested parties should be directed to Drs. W. Scott Meyer and Tsu-huei Liu at the address shown on the front cover.

The interactive plotting program of Section 5.0A is available for VAX users who also have a Tektronix CRT terminal and PLOT10 software (or one of the several available imitations). But note carefully that PLOT10 is proprietary with Tektronix, that a user can run the VAX interactive plotting program in the vector-graphic mode without alteration only if he has purchased a Tektronix PLOT10 interface. Instructions for the use of interactive plotting will be found in Ref. 8, Vol. IX, 11 May 1979, pagination "PIEP".

A similar statement applies to CalComp or simulated-CalComp output of either the EMTP or the interactive plotting program (the "COPY" command of "TPPLOT"). Only if the user has purchased a CalComp or CalComp-like plotting capability (BPA uses an 11-inch Versatek printer/plotter) can CalComp plotting be utilized.

B. Content of Standard VAX EMTP Tape

Requests for the VAX EMTP should be mailed to Program Maintenance at BPA, and should be accompanied by a reel of magnetic tape. For the full package in uncompact form, a full 2400 feet of tape are required. Just the executable version EMTP.EXE can be put on a very small reel (e.g., 400 feet), but this has not been used much, since most contacts prefer the source code. The default tape format is 9-track, 1600-BPI, labeled with "EMTP", and the tape is created using VAX/VMS \$COPY commands. The following is an explanation of VAXTAPE.COM, which is commonly used for 2400-foot reels of tape. First, consider essential lines of the command procedure itself:

```

$ ITAPE EMTP
$ MT EMTP TAPE
$ COPY DRB2:[EMTPTEST]DC*.DAT TAPE
$ COPY SERVO.DAT TAPE
$ COPY [SCOTT]INC*.DAT TAPE
$ COPY [SCOTT]TPPLOT.FOR TAPE
$ COPY [SCOTT]TPPLOTKOM.FOR TAPE
$ COPY [SCOTT]TPPARAM.DAT TAPE
$ COPY PLOTDAT.FOR TAPE
$ COPY [SCOTT]MDDHMMSS.PL4 TAPE
$ COPY MEMORANDA.REF TAPE

```

X-j1

```
$ COPY [UTPF]UTPF PARTS.SPL TAPE
$ COPY [TSU]VARDIM.EXE TAPE
$ COPY [TSU]VARDIM.COM TAPE
$ COPY [TSU]NEWMODS.FOR TAPE
$ COPY LISTIZES.DAT TAPE
$ COPY [UTPF]VAXUM.DAT TAPE
$ COPY [SCOT]EMTPSETUP.COM;1 TAPE
$ COPY [UTPF]*.FOR;61 TAPE
$ COPY CONTROLC.OBJ TAPE
$ COPY BLOCKDSPY.* TAPE
$ COPY [TEMP]*.FOR;61 TAPE
$ COPY [TSU]EMTP.EXE TAPE
$ DIRECTORY MTAO:
```

F1) EMTPSETUP.COM is the command procedure which will compile and link all EMTP FORTRAN. Execution takes about an hour on our VAX-11/780 when I am all alone, as was the case during the evening of February 27th, when the "M38." VAX EMTP was created.

F2) The [TEMP]*.FOR;61 files are the 300 or so SUBROUTINE and/or FUNCTION modules which make up the EMTP proper. For use, these files and those of Point F3 should be in the same directory along with EMTPSETUP.COM at the time of compilation.

F3) The [UTPF]*.FOR;61 files constitute all of the INCLUDE files of the VAX EMTP FORTRAN --- some 30 in number.

F4) LISTIZES.DAT is the 4-line file of EMTP variable-dimensioning table sizes which are requested by the user. For standard BPA setup, times default dimensioning is used (that is the meaning of 90000003 on the second card, as described on page xv-1, Point 6). For example:

```
90000000
90000003
0
+50000
```

Due to KBURRO = 1 usage of virtual working space, only one field of the offsets (4th) card is actually used.

F5) "VARDIM" is the variable-dimensioning program, and it produces the NEWMODS.FOR file (on unit FOR007) which is needed for any subsequent EMTP LINKing. The program reads LISTIZES.DAT from unit 5, and produces a very few lines of printout on unit 6.

F6) The file [TSU]EMTP.EXE is an executable version of the VAX EMTP, dimensioned to three times default list sizes (using LISTIZES.DAT). As per EMTPSETUP.COM, the interactive debugger is "on". If virtual image size is a problem, the recipient can compile and link without the debugger (change "/DEBUG" to "/NODEBUG"). Or more precisely, it is only the linking must be with "/NODEBUG" (one really does not have to change the compilation, if the difference in compilation time is of no concern, or if maybe you might want to selectively use the debugger later).

F7) The first 75 DCXX.DAT files, plus twelve DCNEWX.DAT files, constitute test cases which can be used by the recipient. BPA's latest solutions (the LUNIT6 line printer output files) are not on the tape, but are available from time to time on microfiche (e.g., the

VAX
VAX
VAX
VAX
VAX
VAX

fiche set entitled "M38EMTP"). Remember that DC-1 is quite large (but does fit within 3 times default dimensioning), while DC-2 is time-consuming (it is a good-sized Monte Carlo study). These are two exceptional test cases which many recipients will want to avoid. All data cases are complete, including the extra blank card at the end to stop execution. Solutions are on microfiche only (not on the tape).

F8) "TPPLOT" is the interactive EMTF plotting program (TPPLOTKOM.FOR is the associated INCLUDE file), and MDDHHMSS.PL4 is a small test data file (i.e., a simulated EMTF plot file). It involves 1001 points, and four curves: a sine wave, a cosine wave, a linear ramp, and an exponential. In case the recipient wants to vary the number of time steps or the curves in MDDHHMSS.PL4, see PLOTDAT.FOR which created it. Refer to the first Memo of Vol. IX (Ref. 8) for user instructions of "TPPLOT". There also is a "HELP" command at each of the three levels (OUTER, MIDDLE, and INNER) of program prompts to the user. For different terminals, different program parameters are applicable, and these can all be set at execution time. The file TPPARAM.DAT contains data which is to be connected to unit 30 (\$ ASSIGN TPPARAM.DAT FOR030) before execution of "TPPLOT", for the case of Tektronix PLOT10 plotting. The "SET DATA" (an OUTER-level command) parameters are to be built into this file, and available subsets now apply to our big-screen 4014, a small-screen 4006, and Tsu-huei's Retrographics-enhanced DEC VT100.

F9) The 21 DCPRXX.DAT files will only be of interest in case of trouble, generally. All involve DIAGNOSTIC printout, and most are small, simple problems.

F10) UTPFPARTS.SPL shows a list of all EMTF modules, in order. This information is also contained in EMTFSETUP.COM (except for INCLUDE files), although UTPFPARTS.SPL is much more compact. It can be displayed on an 80-column printer or CRT terminal.

F11) File VAXUM.DAT is a concatenation of all installation-dependent modules of the VAX EMTF, so is most useful to those adapting the program for other computer systems.

F12) CONTROL.C.OBJ, the lone object file on the tape, is only being sent because we have no FORTRAN. This is to satisfy the user-keyed interrupt of interactive (SPY) usage, wherein CTRL-C provides the break.

Along with the tape, the DECwriter console printout which documents the tape creation will be packed. This will show a listing of all files (\$DIRECTORY of tape), thereby confirming that the tape should be readable.

C. Common Usage of VAX EMTF Materials

Basic execution procedures

EMTF execution is normally done on the VAX via a command procedure file such as GOEMTF.COM which follows:

```
$ ASSIGN EMTFDATA.DAT FOR005
$ ASSIGN PRINTOUT.LIS FOR006
$ SET WORKING/LIMIT=400
$ RUN/NODEBUG [TSU]EMTF.EXE
```

VAX
VAX
VAX
VAX
VAX
VAX
VAX

It is here assumed that the data case (or cases) to be solved has been stored on disk as a file named EMTPDATA . The EMTP printout goes on disk, too, as a file named PRINTOUT.LIS. Should a printed copy of the output file be wanted, the command \$ PRINT/DELETE PRINTOUT will do the job (and destroy the file when completed). Alternatively, the user may be operating remotely through a terminal, and he may want to take a look at the output file using a VAX text editor (SOS or EDT), before any final disposition is to be made. In this case, \$ EDIT PRINTOUT.LIS is all that it takes. All of these options for handling the output file are possible because of the ASSIGNment of a disk file to FOR006.

There still is the choice between batch-mode and non-batch-mode of execution. I hesitate to call the latter "interactive", due to the possible confusion of this VAX terminology with EMTP terminology (where "interactive" means something much more powerful, as will be described later). The choices are:

a) The command "\$@GOEMTP" will result in non-batch execution of the EMTP. Often, the "\$ ASSIGN PRINTOUT.LIS" command would be omitted in this case, so that program output would be written to the CRT terminal as it is generated. This mode is very useful, provided the volume of output is not excessive, and provided the terminal is driven at sufficient speed (all in-house BPA CRT terminals run at 9600 baud). But such usage can be quite unsatisfactory for slow typewriter terminals (e.g., our own 30 character per second DECwriter console). If a CRT is used, then no permanent copy of the EMTP output is preserved, unfortunately (once it rolls off the top of the screen of a dumb terminal, it is gone forever). A final disadvantage is that the terminal is tied up during this non-batch mode of EMTP execution.

b) The command "\$ SUBMIT GOEMTP" will result in the queueing of the command procedure for batch-mode solution. This is the basic form of the command, with variations possible based on local decisions as to priorities, resources, etc. VAX/VMS will respond with some acknowledgement like "Job 287 entered on queue SYS\$BATCH". At this point the terminal is free, and the job is out of the user's hands. Most production EMTP studies at BPA (by Al Legate and Bob Hasibar) are so executed. A file should always be assigned to unit 6 in this case (otherwise, output goes to the default disk file FOR006.DAT).

Such discussion of DCL (Digital Command Language) usage could go on and on, of course. Very powerful and flexible things are possible, although they are beyond the scope of the present discussion. The voluminous "VAX-11 USER; Student Guide; Student Workbook" produced by DEC is an excellent motivator for the innovative use of the system. Less tutorial, but also excellent, is the DEC "VAX/VMS Command Language User's Guide." Most basic of all, and the simplest to read, is the DEC "VAX/VMS Primer." All of this material is available through DEC, and not BPA, of course.

Because production versions are compiled and linked with the interactive debugger "on", the "/NODEBUG" qualifier is required on the execution request, to bypass such usage. But if this very powerful diagnostic tool is wanted, consult the DEC "VAX-11 Symbolic Debugger Reference Manual". As of April, 1984, there are no special problems with the debugger (all modules can be entered, and commands seem to be reliable).

VAX
VAX
VAX
VAX
VAX
VAX

Plotting of VAX EMTP solutions

Plotting with the VAX EMTP is easy. The "PRINTER PLOT" feature always works, of course, and it shall not be mentioned further. Quality EMTP plotting (so-called EMTP CalComp plotting) requires that the user link the EMTP along with his CalComp plotting modules "LINE", "GRID", "SYMBOL", etc. Interactive plotting "TPPLOT" will produce line-printer type plots for anyone, using any terminal (including 80-column alphanumeric terminals). But for vector-graphic plotting on Tektronix terminals, interactive plotting must be linked along with the user's PLOT10 package. Saving of the plot file after an EMTP simulation is done automatically, if miscellaneous data parameter "ICAT" has been given a value of one or two. The form of the plot file name that results is MDDHHMMSS.PL4, where ".PL4" is simply a characteristic file type, and "MDDHHMMSS" are digits of the date and the time. The "M" is a hexadecimal digit for the month (with "A" for October, "B" for November, and "C" for December). Files are created in the directory of the user, so can be inventoried using the command "\$ DIR *.PL4".

As for the "REPLOT" feature of Section 1.0d, this requires a special format (do not try to use the one shown) which is as follows: "REPLOT, FILE, IPRSUP". This is free-format after the key word "REPLOT" (which must begin in column 1), so blanks can otherwise be interspersed at will. The commas (",") are the familiar free-format field separators. Data item "FILE" must be a legal VAX/VMS file specification (e.g., [TSU]A17234105.PL4) of 25 or fewer characters, and IPRSUP is an integer constant used for DIAGNOSTIC printout control.

Usage of "TABULATE ENERGIZATION RESULTS"

As for the use of "TABULATE ENERGIZATION RESULTS" of Section 1.0e6 (or alternatively, use of "STATISTICS OUTPUT SALVAGE" of Section 1.0e7), there are two disk files for each "STATISTICS" data case that was solved and saved:

```
ST3LOGXXX.DAT --- file for LUNIT3 = 3 file ;
ST9LOGXXX.DAT --- file for LUNIT9 = 9 file .
```

Here "XXX" are the three decimal digits that are uniquely associated with the file (see "JFLSOS" in Section 1.0e7). These files are opened without directory specification or version number, so must be in the user's area, and will always be the highest version (if more than one having the same name exists). In the case of "TABULATE ENERGIZATION RESULTS" usage, there will be confirmation of the connection of each disk file in "STATRS" of overlay 29 ---- one at a time, as the attachment is made. These go in pairs, with the "ST3" file following the "ST9" file, for each of the previously-solved "STATISTICS" cases of interest. The opening and confirmation for the file of LUNIT9 are performed as follows:

```
OPEN (UNIT=1, TYPE='OLD',NAME=FILN20,FORM='UNFORMATTED')
WRITE (LUNIT6, 1822) FILNAM
1822 FORMAT ( 20X,
1 '---- SUCCESSFUL OPEN OF 'LUNIT9' DATA ON'
2 ' DISK. PERMANENT FILE NAME =', 3H ', 20A1,
3 3h' . )
```

If there is a VAX/VMS error termination before all such printouts are seen, presumably the file following the last one which was printed

VAX
VAX
VAX
VAX
VAX
VAX
VAX

could not be found on disk by the operating system. Files are taken up in the order of user input, from left to right on each data card. As for the creation of such files in the first place (the preceding "STATISTICS" or "SYSTEMATIC" simulations), file opening is done in "MIDOV1" of overlay 1, without any version number. Hence there is no fundamental problem with using the same characteristic integer JFLSOS more than once, since higher versions will simply be created. However, if any other than the highest version is wanted for tabulation, **RENAMEing** will be necessary (since the **OPENing** by "STATRS" is done without version number).

Allocation of physical memory

The allocation of physical memory (400 pages in the above example, via \$ SET WORKING) will depend on the size of the data case being solved. A figure of 400 pages works well for most production BPA cases, avoiding paging in the time-step loop. But much larger cases have been solved using less memory (see Ref. 8, Vol. IX, 10 June 1979, page USEC-9); there simply is substantial paging, and execution is slowed, both in terms of wall-clock time and also CPU time. Yet even this advice may be dated, since Terry told us perhaps a month or two ago (February of 1984) that the operating system will now automatically increase the memory of a process which is paging excessively (it sounds like a sell out to the PRIME philosophy to me, and I am not really sure whether this is progress, if the user does not have control). The user can and should experiment with limits on physical memory, if the optimization of computer resources is a concern.

Use of MEMSAV = 1 and "START AGAIN" Features

The integer miscellaneous data parameter MEMSAV (see Section 1.0h), when set to unity, will result in a dumping of EMTP memory onto disk at the conclusion of a simulation. The "START AGAIN" request of Section 1.0e15 can then subsequently be used to restart such a halted run. But there are some VAX-dependent aspects to be considered.

First, there is the "file specification" of the "START AGAIN" card. This will be seen by looking at the special line of printout which precedes the extrema:

```
----- SUCCESSFUL SAVING OF /BLANK/ AND /LABEL/ AS
DISK FILE "TPTABLES.BIN" . N1, LTLABL = 1352 225779
```

Thus the file name is "TPTABLES.BIN", in the user's directory, and without version number. Each time memory is so saved, a higher version is created. As for N1 and LTLABL, these are sizes of /BLANK/ and /LABEL/, respectively, in INTEGER*4 words. The latter (LTLABL) is determined completely by the user's variable dimensioning, while the former (N1) may vary with program version (e.g., "M34." and "M38." versions might not be compatible for such mixed usage, even if EMTP list sizes are identical).

A user of the MEMSAV = 1 option should monitor his available disk space closely. First, TPTABLES.BIN is a big file, with my test on 04-JUL-80 showing 1832 blocks (938 Kbytes) in response to a \$DIRECTORY TPTABLES.BIN command. The overhead is thus substantial, if disk is in short supply, using our enormously-dimensioned BPA image.

VAX
VAX
VAX
VAX
VAX
VAX
VAX

This could be drastically decreased if the user cut EMTP table sizes, but then one would have to worry about saving the corresponding EMTP version, which is an even bigger file (6680 blocks for an "M38.+" version). The best general strategy is believed to be the reliance upon one enormously-sized executable image of the EMTP.

Treatment of EMTP free-format using VAX

EMTP free-format rules are covered in Section 0.7. Note that there is mention of possible problems with precision on some computer systems, due to roundoff-like error involved with use of the FORTRAN "***" operation. VAX was one system with this problem. Sometimes only 8 or so digits of significance were achieved, even though all floating-point computation was IMPLICITLY REAL*8). Well, the first attempt at amelioration was to create module "FRENUM", which is called by a near-universal "FREFLD". Module "FRENUM" wrote the characters of the next free-field number on FOR039, and then read them back using VAX free-format: READ (39, *). This was found to be fully accurate, but was amazingly slow in real time. It was with "M28." idents that we switched to ENCODE/DECODE instead, with a temporary internal limit of 30 characters in any one number. As far as is known, this is fully accurate, and also fast! But note that it is less than perfectly general.

D. \$-Cards for VAX EMTP

So-called \$-cards were introduced in Section 1.-D, and it is assumed that the user has read that material before continuing with what follows. Concerning format rules, remember that the "\$" and following request word must be a continuous string of characters (with no imbedded blanks). Thereafter, EMTP free-format is used, so blanks are acceptable anywhere (see Section 1.0g6). Well, the following \$-cards are honored by the VAX EMTP :

1. \$ATTACH, FILE, M

This command serves to connect a disk file having name "FILE" (any legal VAX file specification of not more than 25 nonblank characters) to EMTP I/O unit number "M" (an integer constant). The EMTP data card interpretation involves the printing of "FILE" and "M":

```
ATTACH FILE: 25A1 UNIT = I3
```

If I/O unit number "M" is blank or zero, the EMTP will simply connect the disk file to that free channel which has the lowest unit number (e.g., if unit 1 is free, it will be used). Whatever was connected to I/O channel "M" before the new connection is first released (CLOSE operation). A sample usage follows:

```
$ATTACH, [TSU]NED96.DAT;1 , 4
```

2. \$PUNCH, M

This command serves to copy the 80-column card image contents of EMTP I/O unit number "M" (an integer constant) to the card punch. The only problem is that I have yet to find a VAX owner with a card punch! VAX FORTRAN does not honor the CDC output command "PUNCH", either. Cards are going the way of the dinosaur, in this business, anyway. So, doing the best I could, I simply copy the card images to unit 7

VAX
VAX
VAX
VAX
VAX
VAX
VAX

(FOR007). Data card interpretation involves the printing of "M":

COPY FILE I4 TO PUNCH .

The contents of unit "M" are rewound before and after the copy operation; the unit 7 file is not, of course. A sample usage follows:
\$PUNCH, 9

3. \$OUTPUT, M

This command serves to copy the 80-column card-image contents of EMTP I/O unit number "M" (an integer constant) to the line printer (the FOR006 connection). If "M" is zero or blank, a value of 7 is assumed (the card-punch file). EMTP interpretation of the data card involves the printing of "M":

COPY FILE I4 TO OUTPUT .

The contents of unit "M" are rewound before and after the copy. As for the line printer file (FOR006), records are printed single-spaced, with the following identification, beginning in column 20 of the paper:

RECORD I5 . 1 10A8

The I5 field is for the record number (1, 2, etc.), while the "1" to the left of the card image serves to identify the left margin of that image (it is a column-zero marking). A sample usage follows:
\$OUTPUT, 9

4. \$SAVE, FILE, M, N

This command serves to copy the 80-column card-image contents of EMTP I/O channel number "N" (an integer constant) to I/O channel number "M" (an integer constant), and save the result as a new disk file named "FILE" (any legal VAX file specification not having more than 25 non-blank characters). Data card interpretation involves the printing of "FILE" and "M":

SAVED FILE: 25A1 UNIT = I3

The contents of unit "N" are rewound before and after the copy operation, and the newly-created file is disconnected from unit "M" (CLOSE command) after it has been completed. If "N" is zero or blank, it is assumed that the user wants to save a copy of the unit 7 (FOR007) punch file. But do not forget the comma preceding "N", ever. If "M" is zero or blank, the EMTP will simply use that free I/O channel which has the lowest number for creation of the new disk file. A sample usage follows:

\$SAVE, [SCOTT]NEWFILE.DAT, 1, 9

5. \$SPYDATA, FILE, M

This command serves to provide a batch-mode connection of interactive EMTP (SPY) commands which are contained in disk file "FILE" (any legal VAX file specification having not more than 25 non-blank characters). For usage, see Section 9.0 on EMTP interactivity. The connection is made using I/O channel number "M" (an integer constant). Records are read until an end-of-file is encountered, at which point input reverts to the original input unit. The data card interpretation involves the printing of "FILE" and "M":

SPYING FILE: 25A1 UNIT = I3

If "M" is zero or blank (but remember not to omit the preceding comma separator!), the EMTP will simply use that free I/O channel which has the lowest number for connecting the file in question. A sample usage follows:

\$SPYDATA, SPYDEMO.DAT , 0

VAX
VAX
VAX
VAX
VAX
VAX
VAX

6. \$DISABLE

This command marks the beginning of the implicit commenting of a block of data cards; it "disables" the following EMTP data cards. There are no parameters, and the card is universal (it can be implemented on any computer system). Interpretation of this data card will be:

BEGIN DATA TO BE IGNORED.

This implicit commenting then remains in effect until it is cancelled by a later \$ENABLE card (see Section 7).

7. \$ENABLE

This command marks the ending of the implicit commenting of a block of EMTP data cards; it cancels the action of a preceding \$DISABLE card. There are no parameters, and the card is universal (can be implemented on any computer system). Interpretation of this data card will be:

END OF DATA TO BE IGNORED.

8. \$RETURN, M

This command serves to disconnect (CLOSE) a data file which is connected to EMTP I/O channel number "M" (an integer constant). Data card interpretation involves the printing of "M":

CLOSE FILE ON UNIT I3.

If "M" is zero or blank (but remember not to omit the preceding comma separator), I/O channel LUNIT4 = 4, the file of raw plot data points, is assumed.

9. \$NEWFILE, FILE, M

This command serves to connect EMTP I/O channel number "M" (an integer constant) to a brand new disk file named "FILE" (any legal VAX file specification having 25 or fewer nonblank characters). This is in preparation for EMTP-generated, UNFORMATTED data to subsequently be written to the file via the I/O channel number "M". After such file-filling is complete, \$RETURN can be used to disconnect the newly-created file from I/O channel number "M". Data card interpretation involves the printing of both "FILE" and "M":

NEWFIL FILE: 25A1 UNIT = I3

If "M" is zero or blank (but do not forget the preceding comma separator), M = 4 is assumed (corresponding to the file of raw plot data points). Note the restriction to UNFORMATTED files; card-image copying to the file is not allowed. If a corresponding \$-card for FORMATTED usage is desired, we can create it easily enough (call Program Maintenance at BPA). Present thinking is that usage will probably be just for the plot file, which does involve only UNFORMATTED writes. Unfortunately, VAX/VMS forces the user to declare beforehand his choice between these two modes, which is why there is the UNFORMATTED restriction. A sample usage follows:

\$NEWFILE, [AL]PLOTFILE.PL4, 0

10. \$NEW EPSILN, EPS

It is the floating-point miscellaneous data parameter EPSILN of /BLANK/ (deck "BLKCOM") which can be redefined by means of such a declaration. Due to differing uses of EPSILN during the steady-state

and transient solutions, it is possible that the user will want different value; and the indicated card allows such changes wherever data cards are read. Data card interpretation confirms both the old and the new values of EPSILN, as follows:

EPSILN CHANGE. OLD, NEW = 2E11.2

As an historical note, it might be mentioned that the former \$DIAGNOSTIC, which was the original 10th \$-card, was disabled "M31." program versions. With the advent of 2nd-generation EMTF interactivity, there was no longer much need (EMTPSY could change any value such as EPSILN at any time, using shared COMMON). Hence the original usage was removed. As for a sample usage, consider the following:

\$NEW EPSILN, 1.E-10

11. \$DELETE, FILE, M

This command serves to destroy an arbitrary disk file named "FILE" (any legal VAX file specification having 25 or fewer non-blank characters). I/O channel number "M" is simply a free channel to temporarily be used during the destruction process. Data card interpretation involves the printing of "FILE" and "M":

DELETE FILE: 25A1 UNIT = I3

If "M" is zero or blank (but do not forget the preceding comma separator), the EMTF will simply use that free I/O channel which has the lowest number. A sample usage follows:

\$DELETE, [BOB]BYEBYE.BYE;*, 0

12. \$MONITOR, TEXT

This command serves to provide a line of CRT output at the instant the data card is read, for the non-batch mode of EMTF execution. It has meaning and practical use if the output file of FOR006 (unit LUNIT6 = 6) is assigned to a disk file. Then, in the absence of a \$MONITOR cards, there would be no observable terminal activity as EMTF execution would proceed --- until the STOP of "SUBR31" is reached, when "FORTRAN STOP" is written to the terminal by VAX/VMS). Using \$MONITOR, the user can be periodically reassured of the progress of data input.

When the \$MONITOR card is read by the EMTF, the card image will show up in the output file of FOR006, but without any column 1-50 interpretation. The same card image is written to the terminal, and will there be interpreted with printout which includes the data card number NUMDCD :

CRT MONITOR. CARD NUMBER = I5

Here NUMDCD is simply a cumulative count of the number of input records, which provides the user with a measure of positioning. On the other hand, if unit 6 is not assigned to a disk file, then two card images will be seen to the right of column 51, with only the second one being so interpreted (the first will have columns 1-50 blank). As for what happens in the case of batch-mode solution, I have yet to try it. In any case, it is the FORTRAN statement PRINT which is used.

The parameter "TEXT" is arbitrary, and can be punched with whatever identifying information the user wants. Since "\$MONITOR," requires nine columns, 71 remain for "TEXT" (which is not actually processed by the EMTF). A sample usage follows:

\$MONITOR, END OF EMTF BRANCH DATA.

VAX VAX VAX VAX VAX VAX VAX VAX

13. \$LISTOFF

This command serves to turn off the interpreted listing of input data cards, beginning with the card which immediately follows. This \$-card is universal in that it can be implemented on any computer system. It is nullified by a subsequent appearance of \$LISTON (see Number 14 below). Interpretation involves printout of the cumulative data card number NUMDCD:

TURN OFF INPUT LISTING AT CARD I5

Common usage of this feature is to save paper and/or time during the data-input phases of the program, particularly for the users of slow output devices such as 300-baud typewriter terminals. But the user should be aware that more than just the data-card listing can be so turned off. In fact, all production printout (including the data-card listing) is affected. This is because the printout control variable NOUTPR, which was originally added to suppress all output during a "MODIFY DELTAT" restart, is used by \$LISTOFF. Hence do not leave \$LISTOFF in effect beyond the last source card, if such additional suppression of output is not desired.

14. \$LISTON

This command serves to cancel a preceding \$LISTOFF request (see Number 13 above), which turned off the output. The \$LISTON command turns the output back on again. It is universal in that it can be implemented on any computer system. Interpretation involves printout of the cumulative data card number NUMDCD:

TURN ON INPUT LISTING AT CARD I5

15. \$VINTAGE, M

This command serves to redefine the vintage number of data formats which are to be used (where two or more choices are available, it is the vintage number which selects between them). This \$-card is universal (it can be implemented on any computer). Data card interpretation involves the printing of "M", which is the new data vintage number:

NEW MOLDAT = I4 (DATA VINTAGE)

16. \$OLDFILE, FILE, M

This command is identical to that of Number 1 (\$ATTACH), except that it applies to UNFORMATTED files (e.g., plot files of LUNIT4) rather than FORMATTED ones. Also, the data card interpretation is different, using the characteristic identifier "OLDFIL" rather than "ATTACH".

The \$OLDFILE command was actually implemented for usage with postprocessing of old plot files using TACS, as described in Section 1.0e17. For this usage, remember that VAX plot files names are of the form MDDHHMMSS.PL4, and that I/O unit LUNT19= 19. Thus sample usage would appear as follows for a file created on October 13th at 23:41 and 52 seconds:

\$OLDFILE, A13234152.PL4, 19

17. \$STOP

This command serves to terminate execution of the EMTP immediately, by means of a call to the installation-dependent SUBROUTINE STOPTH. For VAX, this just stops locally, after a line of diagnostic output. The \$STOP command is universal in that it can be implemented on any computer system. Interpretation is as follows:

"STOP EXECUTION IMMEDIATELY, IN 'CIMAGE'."

Needless to say, the \$STOP card has little application to normal production usage; it was originally designed for test purposes by Program Maintenance, which may desire to terminate execution at a certain point in the data input.

18. \$WATCH5, M

This command serves to direct 72-column input card images to be written on the screen as they are read by the EMTP, every M-th card. This normally will only be used for non-batch execution of the EMTP through a terminal, with FOR006 assigned to a disk file. Otherwise, there would be no output on the screen as the case executed. Using \$WATCH5, the user can at least monitor the input data as it is being read. Interpretation of this request record involves the printing of "M":

PAINT INPUT DATA ON SCREEN. I8

As for possible values of parameter "M", zero or blank (but do not forget the preceding comma separator) are equivalent to unity, resulting in the writing of each data record to the terminal (CRT screen). To later stop such extra output, simply use a large positive value for "M". Those EMTP data cards which are written to the terminal via this request are slightly truncated, as shown by the FORTRAN at the point of output:

PRINT 3009, NUMDCD, (ABUFF(I), I=1, 9)

3009 FORMAT (1X, I5, 2H :, 9A8)

Integer NUMDCD is the data card number.

19. \$COMMENT

The appearance of such a card serves to toggle the binary switch which controls comment-card destruction. The switch starts in the "ON" position, so comment cards of the user's EMTP data are indeed seen as part of EMTP output. But after the first appearance of \$COMMENT, the status is toggled to "OFF", and comment cards are ignored by the EMTP (and will not be seen on the interpreted data listing). A second and later \$COMMENT would serve to switch back to "ON", etc. Interpretation of this request record is as follows:

TOGGLE COMMENT CARD DESTRUCTION FLAG. I8

The integer printout shows the status after this card has been honored, with "ON" equal to 0 and "OFF" equal to unity.

20. \$WIDTH, KOL

This \$-card allows for the change of width of output to file LUNIT6 during the course of execution. As used here, KOL is an integer constant which should be either 80 or 132 (anything other than 80 is taken to be 132). This is the \$-card equivalent of the special-request cards "OUTPUT WIDTH 80" and "OUTPUT WIDTH 132" (see Sections 1.0g10 and 1.0g11). Interpretation is as follows:

SET EMTP OUTPUT FILE WIDTH. I8

VAX VAX VAX VAX VAX VAX VAX VAX

Common points of transition are between data input and the steady-state solution. For example, if the user wants a more compact printout of branch flows, but all other output should be full (132-column) width, then \$WIDTH, 80 could immediately precede the blank card ending sources, and \$WIDTH, 132 could immediately follow this (to be read in overlay 13, after the phasor solution is complete, assuming to "FIX SOURCE" usage).

E. VAX EMTF FORTRAN and its Modification

For those who want to alter VAX EMTF List sizes, or EMTF FORTRAN logic, we will generally be supplying the VAX translator output corresponding to the last major update. Processing is possible using the file EMTFSETUP.COM, which compiles each EMTF SUBROUTINE or FUNCTION module one at a time, and creates overlay object files whenever a UTPF overlay boundary is crossed. For example, file content in and around overlays 3 and 4 appear as follows:

```
$ SHOW TIME ! BEGIN COMPILATION OF OVERLAY NUMBER 3
$ FORTRAN/NOLIST/DEBUG/NOOP/OBJECT=OVER3.OBJ;61 OVER3.FOR
$ FORTRAN/NOLIST/DEBUG/NOOP/OBJECT=CXRED.OBJ;61 CXRED.FOR
$ COPY OVER3.OBJ, -
  CXRED OV3.OBJ;61
$ SHOW TIME ! BEGIN COMPILATION OF OVERLAY NUMBER 4
$ FORTRAN/NOLIST/DEBUG/NOOP/OBJECT=OVER4.OBJ;61 OVER4.FOR
```

There are about 400 lines of such EMTF FORTRAN compilation. After all EMTF modules have so been compiled, and all overlay object files OV*.OBJ;61 have been created, the separate variable-dimensioning program "VARDIM" will be compiled, linked, and executed. EMTF dimensions are set by the four data cards in file LISTSIZES.DAT which is connected to unit five. "VARDIM" output, on unit 7, is itself compiled, creating the object module NEWMODS.OBJ which is then linked with the EMTF overlay-object files to create an executable EMTF version EMTF.EXE;61:

```
$ SHOW TIME ! BEGIN VARDIM COMPILATION.
$ FORTRAN/DEBUG VARDIM
$ LINK/DEBUG VARDIM
$ ASSIGN LISTSIZES.DAT FOR005
$ ASSIGN NEWMODS.FOR FOR007
$ RUN/NODEBUG VARDIM
$ FORTRAN NEWMODS
$ SHOW TIME ! BEGIN EMTF LINKING.
$ LINK/DEBUG/EXECUTABLE=EMTF.EXE;61 NEWMODS+ -
  [UTPF]OVM1;61+OV0;61+OV1;61+OV2;61+OV3;61+ -
  OV4;61+OV5;61+OV6;61+OV7;61+OV8;61+ -
  OV9;61+OV10;61+OV11;61+OV12;61+OV13;61+ -
  OV14;61+OV15;61+OV16;61+OV20;61+OV29;61+ -
  OV31;61+OV39;61+OV41;61+OV42;61+OV43;61+ -
  OV44;61+OV45;61+OV47;61+OV51;61+OV52;61+ -
  OV53;61+OV54;61+OV55;61+ -
  SYS$LIBRARY:PHASE1/LIB+ -
  DRB0:[SCOTT]CONTROL+C+BLOCKDSPY+[UT]TEKP10.OLB/LIB
```

The final two lines are exceptional in that two items are missing. The CalComp modules come from SYS\$LIBRARY:PHASE1/LIB, while Tektronix PLOT10 modules are contained in [UT]TEKP10.OLB/LIB. The recipient will almost certainly be required to modify these corresponding to his local conventions. Should one or both of the possible plotting modes not be available, it is strongly recommended that a dummy module be

VAX
VAX
VAX
VAX
VAX
VAX
VAX

added, a module containing nothing but the missing routines as dummy ENTRY points. That way, a clean LINK will result (otherwise, there will be so many messages that other, serious messages might be overlooked).

If the VAX user is unable to obtain sufficient virtual address space (nearly 16 megabytes, as of the "M38." code) for this linkage-editing with the interactive FORTRAN interpreter (VAX Symbolic Debugger) turned on, he need only change "/DEBUG" to "/NODEBUG" on the \$LINK card. This should reduce the virtual size by approximately a factor of three (down to perhaps 5 megabytes, for the "M38." version). It is not necessary to recompile with the debugger off, since the linker switch alone seems to be fully effective. However, the compiler output occupies more space when "/DEBUG" is used to qualify the \$FORTRAN command, and this consideration might prompt some user to remove the "/DEBUG" from the file wherever it occurs (easy, using a system editor).

Those who compile EMTF FORTRAN are warned that EMTFSETUP.COM may contain \$RENAME instructions at the end, to move files from one directory to another. These will be present unless someone has already removed them using an editor. If \$RENAME commands are present, they might be modified to suit the user, or deleted (if not needed). Before executing the procedure, it is a good idea to check this. As for directory requirements, there are none. At BPA, we use an empty dummy directory [SCOT], but any other would work equally well.

Those in Europe or Japan who have VAX EMTF interest are requested to contact the Chairman of their Users Group in order to obtain a copy of the program. As a general rule, BPA only mails one copy of such materials to Europe or to Japan, and then all VAX EMTF users of the area share these.

F. Interactive EMTF Execution, Observation, and Control

Section 9.0 explains universal aspects of interactive EMTF usage, so the mention here will be confined to only VAX-dependent details. As of April, 1984, VAX operation is incomplete, and BPA has no immediate plans for enhancement. Any free time or energy for SPY development is aimed at Apollo, to which BPA interactive EMTF interest is confined.

The user-keyed interrupt is the familiar CTRL-C as is used by numerous factory programs. It is object file CONTROLC.OBJ of the EMTF linking which appends this DECUS-supplied routine. Unfortunately, for reasons which are not at all understood, this occasionally fails. It might be one usage out of 10 or 20 which does not correctly result in an interruption followed by the "SPY:" prompt. The user is lucky if the CTRL-C merely becomes (effectively) a CTRL-Y, and the process terminates. More disturbing is the case where the process enters some tight loop somewhere, and is locked. Even CTRL-Y will not terminate execution, and a "\$MONITOR; PROCESSES/TOPCPU" will show intense CPU utilization nearly 100%, if the EMTF is all alone. In such cases, I must log in under the system manager (SYSTEM), and use "\$KILL PID" to break the loop.

VAX
VAX
VAX
VAX
VAX
VAX
VAX

X-j14

Not only is the VAX CTRL-C interrupt less than perfect, but it also erases any typed-ahead SPY commands. Thus time-sharing is ineffective (compare with the Apollo description).

Vector-graphic plotting has yet to be tried. This is confined to the one SUBROUTINE TEKPLT of overlay 20. The module in question began as VAX FORTRAN of the separate plotting program TPLOT.EXE, but was substantially changed after movement to Apollo. If and when work might resume on VAX, it is the Apollo module which should be converted back to VAX, since all logic except the specific output calls should be right. With this in mind, the UTPF contains the Apollo code, not the VAX code, for "TEKPLT".

Multi-terminal (or window) operation has not yet been solved for the interactive VAX EMTP, either. All character output is just sent to FOR006, which is the one and only connected terminal.

VAX
VAX
VAX
VAX
VAX
VAX
VAX
VAX

0.5n SEL EMTF Setup (as used by LABORELEC in Belgium)

Since the early summer of 1980, a SEL computer system has been used for support of the EMTF in Belgium. As of today (16 April 1984), there still is no North American user, so all serious inquiries should be addressed to Europe. It is our understanding that LABORELEC would be happy to make the code available to anyone.

Throughout the winter of 1979/1980, translation principles for a SEL EMTF version were worked out with the cooperation of Messrs. Germy and Verbinnen of LABORELEC in Rhode-St.-Genese, (a suburb of Brussels) Belgium. Mr. Steve Buroker of the Seattle (Washington) office of SEL (Systems Engineering Laboratories computer systems) was also indispensable, as a local adviser. A description of this original SEL EMTF work is summarized in Reference 8, Volume X, 14 November 1980, pagination SSOM.

The first EMTF code mailed to Mr. Verbinnen was of "M26." vintage, and that version continued to be used for some time. After certain intervening compiler problems, the EMTF would seem once again to be SEL-compatible in the spring of 1984, even though the version being used is slightly dated. In a letter dated 6 April 1984, Messrs. Verbinnen and Germy write the following: "We received the M34 release from Prof. D. Van Dommelen at the beginning of January this year, and at the present time, we possess an executable version with full EMTF capabilities (most of the test cases have been executed with success)." This is for a SEL 32/77 computer running the MPX-2.1A operating system, and using the latest FORTRAN 77 compiler and run-time library (both version 4.0). I refer all inquiries to Mr. Verbinnen, who is the SEL computer expert responsible for the EMTF at LABORELEC:

Monsieur J. Verbinnen
Service Mathematique
LABORELEC; Section 9
Laboratoire Belge de
l'Industrie Electrique
B.P. 11
RHODE-ST-GENESE B1640
BELGIUM (BELGIQUE)



LABORELEC

LABORATOIRE BELGE DE L'INDUSTRIE ELECTRIQUE
BELGISCH LABORATORIUM VAN DE ELECTRICITEITSINDUSTRIE
SOCIETE COOPERATIVE COOPERATIEVE VENNOOTSCHAP

SECTION - 9 - SECTIE
SERVICE MATHEMATIQUE
WISKUNDIGE DIENST

ADRESSE POSTALE · POSTADRES RHODE-ST-GENESE 1640 ST-GENESIUS-RODE
TÉL. : 02/358.35.10
TELEX. : 22297 · LABORELEC · BRU. B.

SEL
SEL
SEL
SE
SEL
SEL
SEL
STL

0.5r Apollo EMTF Setup (as used at BPA, in Portland, Oregon)

A. General Background about the Apollo EMTF

The text now being read has its origin in BPA Apollo disk file //A/SCOTT/INSTRUCTIONS, which is the very first file on floppy disk number one of Apollo EMTF materials as they are distributed to others. If text is right-justified, then it has been processed by WSM's home-made "RUNOFF" program. To avoid anachronistic information, always consult the latest disk file, please (the file is expected to evolve with time, just as the EMTF)!

Apollo Computer offers fully-virtual FORTRAN systems which are built around Motorola 68000 or 68010 microprocessor chips; or more recently (late 1983 announcement), around its own proprietary chip. Super-fast vector graphics and network architecture (DOMAIN) are characteristics of these exciting new user-controlled computer systems. With Apollo, there are no "computer centers" as such. Instead, the hardware is distributed around the work environment, with each screen having its own dedicated processor. Peripherals (including disks) are then shared via circular coaxial cable communication which runs at 1.5 Megabytes/sec (see sketch).

FEATURES

- Complete virtual memory computer system on every technical professional's desk.
- Dedicated 32-bit VLSI processor.
- 16 Mbytes virtual address space per process, up to 15 concurrent processes per node.
- .5 to 1.5 Mbytes main memory.
- 12 Mbit per second local-area network.
- Network-wide virtual memory operating system.
- Compatibility with all members of the DOMAIN processing family.
- 1024 x 800 pixel, high-resolution, bit-mapped graphics display.
- Detachable, low-profile keyboard.
- Two asynchronous serial I/O ports.

DN300 INTERNAL ARCHITECTURE

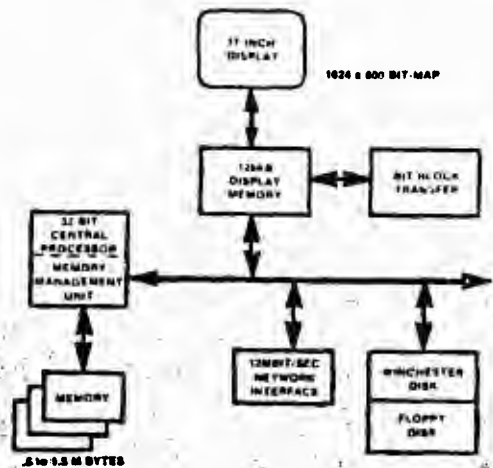

A PROFESSIONAL PRODUCTIVITY NETWORK

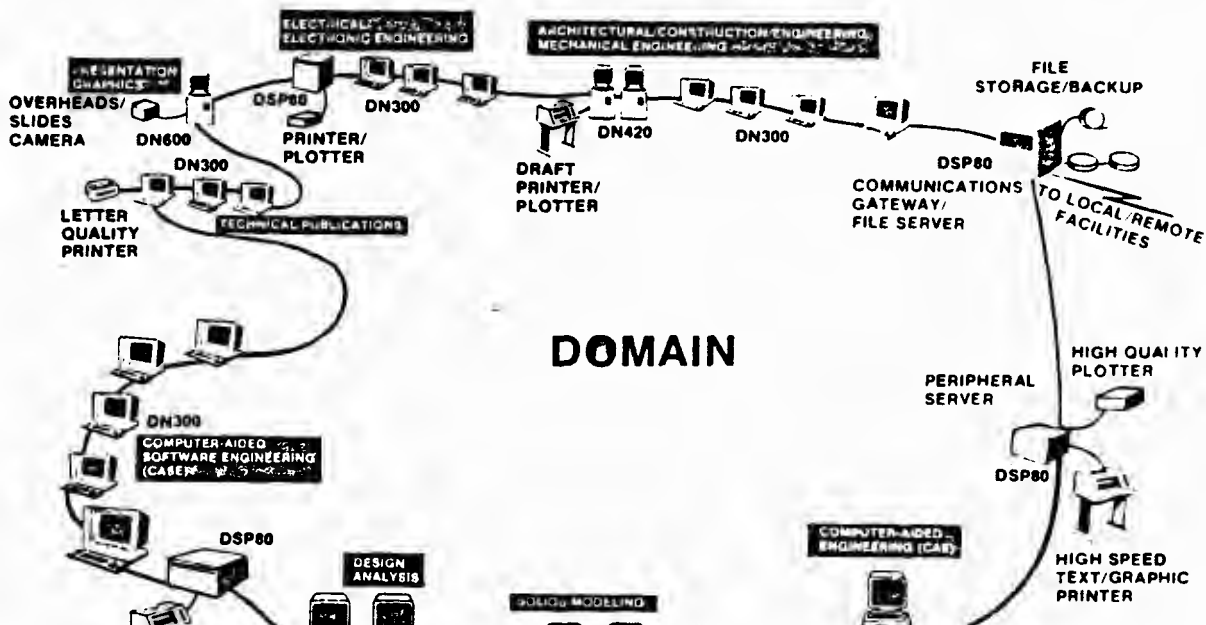

APOLLO APOLLO APOLLO APOLLO APOLLO

Further details can be found in Reference 8, beginning with Volume XI, 18 October 1981, pages SSIA-16 through 18. Apollo was first EMTF-tested in Minneapolis. in cooperation with Minnesota Power and Light (the PRIME EMTF distributor). This initial work by Tom Varilek, Jim Weaver, and WSM is described in Volume XI, 24 December 1981, pages DTTM-6 through 12. Subsequent Apollo testing by WSM in Seattle is described in Vol. XII, 6 February 1982, Section VI, pages ECEO-11 through 13. At this point, Apollo was known to be EMTF-compatible, and those at BPA who were associated with the procurement of EMTF computer resources encouraged an initial purchase (one DN420). As of February 1984 when this paragraph is being written, the DN420 remains in the hands of program developers on floor 18 of the Lloyd Center Tower, while two additional DN300s are about to be installed one floor above for the production users of High Voltage Practices. The three nodes will be connected via coaxial cable to form a 3-node ring network using DOMAIN, of course.

BPA's experience with its Apollos has been favorable, and any EMTF-interested party having flexible money is strongly advised to look at the alternative provided by personal computers, with Apollo being a good place to start. Speed of EMTF simulation ranges from about 1/6th or 1/7th of a VAX-11/780 for the most inexpensive, desktop DN300, up to alleged near-equality with the VAX-11/780 for the high-powered, new DN460. But more important than raw machine power are the numerous other desirable features of luxury personal computers such as Apollo: predictable response, reliability, low cost, fully-virtual architecture, an interactive FORTRAN debugger, portability, high-speed vector graphics, arbitrary character fonts, true distributed processing, and windows. Overall, microcomputers are believed to represent an exciting EMTF trend of the future. Apollo just happens to be the first luxury personal computer to support the EMTF; there will be others, and the interested reader is urged to check each and every attractive possibility (the market is very dynamic, with price/performance and functionality changing rapidly).

Fully-exploited EMTF interactivity is a strength of the Apollo program version. Yes, batch-mode execution continues to have a role. but interactive execution is much more powerful, flexible, productive, and fun! The gateway to such usage is "SPY", which is to be sent in response to the initial one-line prompt which begins program execution:

\$EMTF. EXE

EMTF BEGINS. SEND (SPY, \$ATTACH, DEBUG, HELP, MODULE, JUNK, STOP) :

This command will typically be sent in a window having either F5x7 or F5x9 character font, to allow for 132-column output (the normal EMTF LUNIT6 line printer output). The window should be nearly full width, and should occupy the bottom 3/8ths of the screen only, if overlap is to be avoided. Shortly thereafter, two windows will automatically open in the top 5/8ths of the screen. The left window has an input pane, and at this point the user should move the cursor to it for all future input (nothing further will be read from the original window in which EMTF execution began). The window on the right is for vector-graphic display of the on-going simulation, in response to the "PLOT" command of SPY. Begin SPY dialogue by sending "HELP" in the pane of the upper-left window, to produce a menu of available commands, and details of each (exit by sending "SPY"). Further details about Apollo EMTF SPY operation can be found in Section B below, and sample hard copy of the 3-window screen is shown on the following page.

For batch-mode (non-interactive) EMTF execution, it is the \$ATTACH option of the just-shown initial EMTF prompt which must be used. The associated EMTF data file name, a legal Apollo Aegis disk file name, is to follow, separated by commas. For example:

\$ATTACH, //A/TEST/DC70.DAT,

APOLLO
APOLLO
APOLLO
APOLLO

I H S

```

SPY: DATA
SEND EMTF DATA FILE NAME (CONTROL) : //A/TP/DC4.DAT
39 = NUMCRD (upper bound on card-image storage)
SPY: GO
SPY: BREAK
SEND T-break IN SEC. ("-" MEANS STEP #): -5
Ok, using DELTAT = 0.500E-02 this gives T-break =
SPY: // Start "BREAK" service in "EMTSPY". NCHAIN =
SPY: PLOT
--- OUTER :
Time limits are : 0.000000E+00 0.200000E-01
--- MIDDLE : CHOICE
Type-1 entries (node voltages).
GEN TRAN
Type-8 entries (branch voltages or powers).
GEN TRAN TRAN LOADG
Type-9 entries (branch currents or energies).
TRAN GEN TRAN TRAN LOADG
--- MIDDLE :
SEND NODE NAME OR END ( ) : TRAN
SEND NODE NAME OR END ( ) : END
SEND BRANCH VOLTAGE NAMES OR END ( ) : Gf
SEND BRANCH VOLTAGE NAMES OR END ( ) : Lf

```

I I S

V e r t i c a l A x i s 1.E1

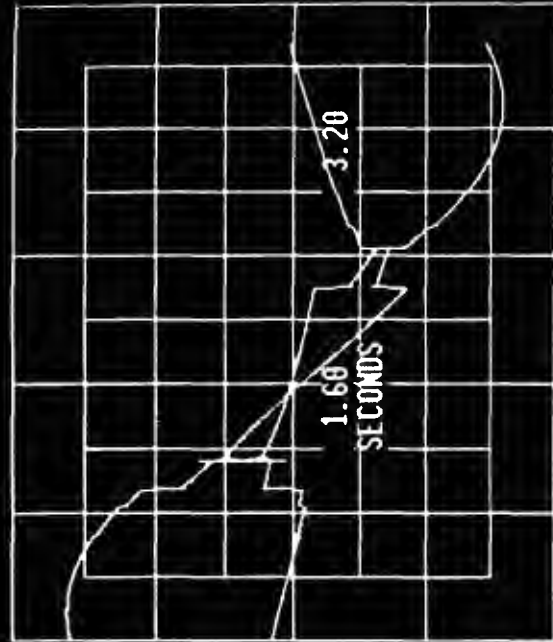

8.00
0.00
-8.00

NAMES : TRAN GEN TRAN
YMIN, YMAX, DY/IN = -0.8000E+02 0.8000E+02 0.4000
TMIN, TMAX, DT/IN = 0.00000E+00 0.40000E+01 0.80000

I I S

```

FIRST 2 OUTPUT VARIABLES ARE ELECTRIC-NETWORK NODE VOLTAGES (WITH RESPECT TO LOCAL GROUND)
NEXT 3 OUTPUT VARIABLES ARE BRANCH VOLTAGES (VOLTAGE OF UPPER NODE MINUS VOLTAGE OF LOWER NODE)
NEXT 3 OUTPUT VARIABLES ARE BRANCH CURRENTS (FLOWING FROM THE UPPER EMTF NODE TO THE LOWER)
FINAL 8 OUTPUT VARIABLES PERTAIN TO DYNAMIC SYNCHRONOUS MACHINES, WITH NAMES GENERATED INTERNALLY
BRANCH POWER CONSUMPTION (POWER FLOW, IF A SWITCH) IS TREATED LIKE A BRANCH VOLTAGE FOR THIS GROUPING!
BRANCH ENERGY CONSUMPTION (ENERGY FLOW, IF A SWITCH) IS TREATED LIKE A BRANCH CURRENT FOR THIS GROUPING.

```

STEP	TIME	GEN	TRAN	TERRA	TRAN	LOADG	TRAN	GEN	TRAN	LOADG	TRAN
0	0.000000	0.780000E+02	0.637297E+02	0.627826E+01	0.637297E+02	0.637297E+02	0.188825E-02	0.236763E+00	0.232279E+00	0.232279E+00	0.232279E+00
1	0.005800	0.699991E+02	0.637856E+02	0.621353E+01	0.637856E+02	0.637856E+02	0.183512E-02	0.237269E+00	0.232726E+00	0.232726E+00	0.232726E+00
2	0.010000	0.699985E+02	0.638398E+02	0.615665E+01	0.638398E+02	0.638398E+02	0.178194E-02	0.237769E+00	0.233167E+00	0.233167E+00	0.233167E+00
3	0.015000	0.699921E+02	0.638925E+02	0.609962E+01	0.638925E+02	0.638925E+02	0.172872E-02	0.238263E+00	0.233602E+00	0.233602E+00	0.233602E+00

Control:

Fig. 1. Photograph of DN420 screen during interactive Apollo EMTF solution of BENCHMARK DC-4 All windows are rolled back with the upper ones at the start and the bottom one in the middle.

Then only one window (nominally of nearly full width, and with an F5x7 or F5x9 font) is needed, and program LUNIT6 output will be written to that window as it is generated. In this mode, there is no punch file, although users can without much difficulty use MARK, COPY and PASTE keys (of a DN300 keyboard) to extract any desired card images, which generally will be listed on the LUNIT6 output as well as the LUNIT7 "card punch" (it is only the latter which is unavailable).

Although it has nothing special to do with the EMTP program, the Apollo EMTP user is reminded of the importance of cleaning out unneeded backup files of the Apollo editor. From time to time we issue wild-card deletes of these, and are astounded by the resulting free disk space. I use the shell command "\$DLF /%/%.BAK -NQ" from time to time, particularly when there has been editing of the big EMTP FORTRAN files /TP/%.FTN.

Slightly more complicated is batch-mode execution with the LUNIT6 output going to disk rather than the window in which execution begins. For this, a "DISK" command must precede the just-described "\$ATTACH" usage, and a name for the desired output disk file must follow it. To illustrate this, as well as use of a parameter as an argument of an Aegis command procedure, consider the following listing of the essential lines of //A/SCOTT/TIME, which was written for BENCHMARK DC-XX test cases:

```
von
EMTP.EXE <<!
DISK
$ATTACH, //A/M35/DC^1.dat,
//B/EMTP/DC^1.LST
!
VOFF
```

The appearance of "^1" represents a request for the replacement of these two characters by the first (and in this case, the only) argument of the execution command. Hence the Aegis shell command "\$TIME 70" will execute the EMTP using disk file //A/M35/DC70.DAT for input data, and //B/EMTP/DC70.LST for the disk file to store LUNIT6 output. If the solution punches cards, the LUNIT7 card images will be found in //B/EMTP/DC70.PCH (only the file type differs from the LUNIT6 output).

B. Apollo SPY (Interactive EMTP) Usage

In this present subsection, installation-dependent aspects of the interactive Apollo EMTP (SPY) will be detailed. Because universal aspects are described for all computer systems in Section 0.9, that universal material will not be repeated here. Rather it is only special peculiarities of Apollo EMTP interactivity which will be detailed in the present subsection.

B-1. SPY Pads --- Names, Sizes, Font, HOLD, Time-Sharing, etc.

Unless the user employs the "JUNK" command (see Point B-2 below), the two upper SPY windows will be named JUNKA and JUNKB, as is readily seen in the upper border of each. When a simulation ends (either following a clean "STOP" command to SPY, a CTRL-Q interrupt of the process, or an internal, undesired interrupt by Aegis, the user will rapidly see "*** Pad Closed ***" messages in both of the upper windows; then the \$-sign prompt of Aegis will return to the lower, original window in which EMTP execution began. To close the two upper SPY windows, use CTRL-N on each of them in turn. If nothing further is done, window contents will remain as disk files until a second EMTP execution begins, at which time the program will automatically delete them. Should the user want to preserve them, they should be renamed or copied prior to such erasure, of course, or the pad names could be varied (see the "JUNK" command below).

APOLLO
APOLLO
APOLLO
APOLLO

The font used for the SPY pad JUNKA is simply that one which is in effect for the Apollo node as execution begins. For easy reading (albeit with some truncation on the right), the F7x13.B has merit. Immediately prior to sending "\$EMTP.EXE" in the wide, F5x7 or F5x9 window at the bottom of the screen, set the font: "Command: FL F7x13.B".

During execution, the output portion of SPY pad JUNKA (upper-left) will be locked, so can not be rolled backwards or forwards using the DM scroll-up and scroll-down keys. The scroll-left and scroll-right keys do function normally, however. In order to scroll JUNKA vertically, the HOLD key must be applied (unless and/or until we better learn to control the attributes of the window when the EMTP opens it).

The Apollo EMTP allows full time-sharing without any special contrivance or action on the part of the user. SPY commands are simply typed into the input pane of JUNKA, and provided the window is not on HOLD, will be processed as soon as the EMTP can. Specifically, there is the opportunity to read another line of SPY input whenever an EMTP data card is read (in "CIMAGE"), as well as one at the beginning of each UTPF overlay. Within the time-step loop, there are four opportunities each time step, so for small networks, the response appears to be instantaneous. For most usage, the user need not think about the time-sharing, since it just takes care of itself. Yet there are cases where timing or sequencing is critical. If the user sends the SPY command "LOCK", ongoing EMTP execution will be suspended, and SPY dialogue will continue exclusively until the following "GO" (at which point the simulation will be resumed, as time-sharing is re-enabled).

The SPY user-keyed interrupt is none other than the familiar carriage return (RETURN key). Hence, in most cases where EMTP output is repetitive and excessive, and in which the user wants to abort the display, a simple tap on the RETURN key will do the job! Examples of such usage are to abort an ongoing display of a SPY table (e.g., "BRANCH" or "RLC"), or to abort LUNIT6 connectivity, or to abort the phasor steady-state output, or to silence a disaster-level alarm (level-10 usage of the SPY "HONK" command).

In the preceding general instructions, it was recommended that one begin EMTP execution in a window which is both short (3/8ths of the screen height, since the internally opened SPY windows are of height 500 pixels) and wide (to handle 132-column output, a window with F5x7 or F5x9 font must be within about an inch of full width). Then there would be no overlap, which is generally most satisfactory. Yet Apollo certainly has no trouble with overlap, so the user can in fact begin execution in any window of any size, and can MARK and GROW (DN300 DM keys) any of the three windows at any point during the course of EMTP execution. Yet the consequences of partially- or completely-covered windows should be understood. The PLOT window in the upper right is an exception, in that there are no known complications. Any portion of the PLOT window which is not visible is simply unobservable. Yet plotting can go on all the while, without any noticeable complication for the other windows as new graphics are generated in the hidden region. But more care should be exercised with the other two windows. If EMTP LUNIT6 output is partially or totally obscured, the familiar Aegis refresh of the entire window will occur with each new line of output, thereby drastically slowing the display (not recommended). As for a portion of the SPY window JUNKA (upper left) being obscured, this is acceptable only if the PLOT window is hiding the contents (for which there is no problem). But if either the EMTP LUNIT6 window, or some other window not related to EMTP execution, is on top, the first character of SPY text which is typed in the input pane will pop JUNKA to the top, of course (as per expected Aegis behavior for obscured windows). Should anyone want to permanently modify the position or size of the internally-

opened EMTP windows, it is Apollo installation-dependent SUBROUTINE WINDOW of disk file /UTPF/APOLLOMODSNON00.FTN in which all parameters have been fixed.

B-2. Implied File Names : ".PCH", ".PL4"

As presently coded, the user has no control over the plot file (the disk file which might be filled with raw plot data as a simulation progresses), and only limited control over the punch file (for LUNIT7 EMTP output of card images). Later, these names might be made fully variable, but for now, the user must either live with the established conventions, or modify those conventions to suit his needs. Details follow.

First, the plot file. If requested (integer miscellaneous data parameter ICAT positive), this will be a disk file in the default directory of EMTP operation, having file name

PLOTMMDDYYHHMMSS.PL4

where the first four characters are the fixed root name "PLOT", the next 12 come from the current date and time as displayed in the EMTP heading (MM/DD/YY HH.MM.SS at the start of execution). Finally, a pseudo file-type ".PL4" is appended --- a holdover from five years of VAX usage. No two plot files can have the same name, of course (Apollo does not allow version numbers the way VAX does), but this is not a problem. In case two simulations begin during the same second, the one which is slightly retarded will have the seconds count "SS" incremented by one until the conflict is removed. Should such a perturbation of the expected name occur, there will be an associated LUNIT6 warning message, produced by Apollo module "SYSDEP" (stored in disk file /UTPF/APOLLOMODSNON00.FTN).

Unless the user sends the EMTP LUNIT6 output to disk, there will be no permanent punch file. Yet this does not mean that card images can not be recovered. Using the MARK, COPY, and PASTE operations (DN300 DM keys), a copy can be extracted from the listing which normally is part of the LUNIT6 which goes to an Apollo window. Yet this is a little indirect. If the user really expects LUNIT7 punched EMTP output, it is probably simplest to send "DISK" in response to the original EMTP SPY prompt. Then the EMTP will prompt for a desired file name for LUNIT6 EMTP output. Assuming that this name involves a period, with a pseudo, 3-character file type to the right (e.g., DC42.LIS), then ".PCH" will replace this in the name used for the LUNIT7 file (e.g., DC42.PCH). Yet the user should also be warned that numerous such vacuous files can result, since if "DISK" is used, there will be a punch file on disk whether the EMTP writes anything to LUNIT7 or not. I say "vacuous," but in fact I believe that a \$LD command will show some minimum size like 32 bytes. So, be prepared to eliminate these via the wild-card deletion command "\$DLF /TP/%.PCH" from time to time (after having first renamed any which should be saved), if the accumulation is bothersome.

B-3. Exceptional Window Usage: Non-Default Names, Locked Pads

If no precautions are taken, two or more simultaneous users of the interactive EMTP will both attempt to use pad names JUNKA and JUNKB for the upper windows. This leads to a conflict with Aegis, which will prevent any second such usage. While it is unlikely that more than one interactive simulation would occur at the same time on any one node, there is a very real concern for those with diskless nodes. The second or later user must vary the root name of the pads via the "JUNK" command, to make it distinct. This is to be the very first response to the initial EMTP prompt. It is equivalent to a request of file renaming, plus an associated implicit "SPY" (which need not be sent). That is, following the JUNK command, the EMTP will prompt for a replacement name; once this is received, the upper windows will open just as they normally would, automatically.

Occasionally pads JUNKA or JUNKB may be uneditable or undeletable because they are locked, for reasons which can not be fully explained (the result of some abnormal sequence which has confused the operating system). For example, consider the following attempt to make a copy of the upper-left SPY pad:

```
$ CPF /TP/JUNKA /TP/JUNKAA
?(cpf) "/tp/junka" - object is in use (OS/file server)
```

To confirm that such an object is locked, issue a request for the display of all locked objects: "\$LLKOB". Among the 30 or so entries, the offending file JUNKA should be found. To free this, issue a "forcible unlock" command: "\$ULKOB JUNKA -F". Then all should be well (disk file JUNKA can be copied, edited, deleted, etc.).

Occasionally, interactive EMTF execution might fail immediately after the initial "SPY" request is sent, due to problems with locked-objects as just described. Since system status flags are checked in SUBROUTINE WINDOW of FORTRAN file APOLLOMODSNONOO.FTN, this would be a clean refusal on the part of EMTF FORTRAN to continue, such as the following:

```
$ emtp.exe
EMTF BEGINS. SEND (SPY, $ATTACH, DEBUG, HELP, MODULE, JUNK, STOP) :
SPY
Error in "WINDOW". STOP. ISTAT = 1100008
Fortran STOP
```

Again, this is abnormal, since the user has done something wrong (who knows what?!). By forcibly unlocking JUNKA and JUNKB, any such problem should be cured.

C. Importance of "Node //A" (Node Entry Directory //A)

In the following section, the distribution of Apollo EMTF materials on floppy disks is described. In order to avoid modification of the cookbook procedures which have been provided, it is important that naming trees of the recipient match those in use here at BPA. The only tricky part of this is the node name, since "//A" has been assumed, and most likely this will not correspond to the recipient's node name. Reconciliation of such a difference is explained in the remainder of this subsection.

A word about semantics. What I sometimes refer to as "node //A" is more properly referred to as the "node having node entry directory //A." Since we at BPA only have one "/" name associated with each node, there is a one-to-one correspondence, so we can use the more compact notation "node //A" without any confusion. For the proper terminology, see "Getting Started With Your DOMAIN System," SR6.0, the section entitled "Node Entry Directories" on page 2-2). If other users could receive and process EMTF materials on their own "node //A", this would be ideal, since it would ensure compatibility with us in Portland. We use "//A" for our DN420, "//B" for our DN300 with disk, and "//C" for its diskless DN300 partner node.

It is true that one can just create "//A" on any existing node at any time, if such does not already exist. The shell command is trivial:

```
$CRD //A
```

But we avoid this approach, due to potential resulting confusion. Setting working directories then becomes tricky, and WSM is not prepared to cope with such subtleties. Based on THL's and WSM's observation of Ken Strong's usage in the local Apollo office on March 14th (during preparation for the DN460 benchmarking), we are not the only ones who can be confused, either! Unless and/or until some sophisticated user steps forward with an air-tight, written explanation of such usage, and until he demonstrates correct operation, I prefer to rely upon node renaming (the remainder of this subsection).

Based upon experimentation at BPA, it would appear that any other node entry directory name (e.g., Ned's "//POWER" in Minneapolis) could easily be temporarily changed to "//A" --- just during the floppy copying and EMTF setup. Then, once this is done (within three hours for a DN300 with one megabyte of memory, if nothing goes wrong), the original node name could be restored without any lingering complications to any files. As long as there is no time-sharing with other non-EMTF processes on the node of interest during the EMTF operation, and as long as no other node of the network attempts to access files of the node being used during the period of work, there should be no adverse effect of the temporary name change. The procedure for such a temporary change of node name is really remarkably simple. For purposes of illustration, let "//ROOT" be the assumed original node name, and "HEX4" be the node ID. Then precede processing of the new EMTF materials by:

```
$UCTNODE ROOT
$CTNODE A HEX4
$CRD /SCOTT /TSU /UTPF /TP
```

Note that the third of these lines creates the four required EMTF directories mentioned above, assuming that they do not yet exist. Should such directories already exist, this step should be omitted. Or, if the user really wants to begin cleanly, from nothing (from level zero), he could delete such existing directories before beginning with these three commands:

```
$DLT /SCOTT /TSU /UTPF /TP
```

This assumes that the four directories in question are reserved for just Apollo EMTF materials (if other, unrelated files are present, they will be destroyed in the process, note, so be careful of such usage). Yet this would be my general recommendation: reserve the four directories for nothing but Apollo EMTF materials. Then, when new materials arrive, all old ones can be destroyed, since they are being replaced completely. Finally, after all EMTF floppy disks have been copied, and EMTF FORTRAN is translated, compiled, and bound (as will be described shortly), restore the original node name:

```
$UCTNODE A
$CTNODE ROOT HEX4
```

I can conclude this explanation of node renaming with an explanation of the exceptional circumstance which would result if some node of the DOMAIN network already is named "//A", but if this node is not the one into which the EMTF materials are to be read and processed. Such is the case at BPA, for testing of the materials which we send to others. It is much more convenient for us to use our DN300 with local 34 Mbyte Winchester disk --- presently node "//B" with node ID F40. But before "//B" can be changed to "//A", we must first change the present "//A" (our DN420) to some temporary, unused name like "//Z". For testing during the morning of March 15th, THL and WSM used the following sequence of operations:

```
Through the DN420 keyboard: $UCTNODE A
                             $CTNODE Z 465
Through the DN300 keyboard: $CTNODE -UPDATE
                             $UCTNODE B
                             $CTNODE A F40
```

Then our DN300 is ready to receive EMTF materials as node "//A". Once all such processing (including EMTF translation, compilation, and BINDing) is complete, we restore the original names as follows:

```
Through the DN300 keyboard: $UCTNODE A
                             $CTNODE B F40
Through the DN420 keyboard: $UCTNODE Z
                             $CTNODE A 465
Through the DN300 keyboard: $CTNODE -UPDATE
```

When this is all done, the display of \$LCNODE (list connected nodes), issued through either keyboard, should show that original entry directory names "//A" and "//B" have been restored.

D. Distribution of Apollo EMTF Materials; Reading Such Materials

The standard distribution of Apollo EMTF materials is on four sets of floppy disks, created by four command procedures //A/SCOTT/GIVE1.COM through GIVE4.COM. Both for simplicity and reliability (independence), the first three of these involve conventional file copying (\$CPF), and they produce just the first three diskettes (for each command procedure, all files fit onto a single floppy disk). The recipient can use parallel command files RECEIVE1.COM through RECEIVE4.COM to copy the Apollo EMTF floppies onto his Winchester. Consider essential lines of RECEIVE1.COM first:

```

MTVOL F /FLOP
CPF /FLOP/INSTRUCTIONS //A/SCOTT -R
CPF /FLOP/APOLLOMODS00.FTN //A/UTPF -R
CPF /FLOP/APOLLOMODSNON00.FTN //A/UTPF -R
CPF /FLOP/CIMAGE.FTN //A/UTPF -R
CPF /FLOP/CALCOMP.FTN //A/UTPF -R
CPF /FLOP/TEKPLTPLUS.FTN //A/UTPF -R
CPF /FLOP/BLOCKDSPY.FTN //A/SCOTT -R
CPF /FLOP/APOLLOET.COM //A/SCOTT -R
CPF /FLOP/APOLLOET.FTN //A/SCOTT -R
CPF /FLOP/APOLLOKOM.INS.FTN //A/SCOTT -R
CPF /FLOP/EMTPCOMPILE.COM //A/SCOTT -R
CPF /FLOP/TPPLOT.FTN //A/SCOTT -R
CPF /FLOP/TPPLOTKOM.INS.FTN //A/SCOTT -R
CPF /FLOP/TPPARAM.DAT //A/SCOTT -R
CPF /FLOP/PLOTDAT.FTN //A/SCOTT -R
CPF /FLOP/INC%.DAT //A/TP -NQ -R
CPF /FLOP/LISTMAKER.FTN //A/SCOTT -R
CPF /FLOP/CUTUTPF.FTN //A/SCOTT -R
CPF /FLOP/CUTUTPF.COM //A/SCOTT -R
CPF /FLOP/CUTKOM.INS.FTN //A/SCOTT -R
CPF /FLOP/GENCOR.FTN //A/SCOTT -R
CPF /FLOP/GENCOR //A/TSU -R
CPF /FLOP/TPUPDATE.FTN //A/SCOTT -R
CPF /FLOP/PACKUTPFT.COM //A/SCOTT -R
CPF /FLOP/PUM1 //A/TSU -R
CPF /FLOP/PUM2 //A/TSU -R
CPF /FLOP/LISTSIZES.DAT //A/SCOTT -R
CPF /FLOP/SPYAID.DAT //A/SCOTT -R
CPF /FLOP/SERVO.DAT //A/SCOTT -R
CPF /FLOP/VARDIM.COM //A/TSU -R
CPF /FLOP/EMTPBIND.COM //A/SCOTT -R
CPF /FLOP/GIVE1.COM //A/SCOTT -R
CPF /FLOP/GIVE2.COM //A/SCOTT -R
CPF /FLOP/GIVE3.COM //A/SCOTT -R
CPF /FLOP/GIVE4.COM //A/SCOTT -R
CPF /FLOP/RECEIVE1.COM //A/SCOTT -R
CPF /FLOP/RECEIVE2.COM //A/SCOTT -R
CPF /FLOP/RECEIVE4.COM //A/SCOTT -R
DMTVOL F /FLOP

```

This restoration of floppy disk number one provides everything except BENCHMARK DC-XX data cases and the UTPF, which are the subjects of the remaining command procedures (described below). In order to avoid confusion and/or conflict involving directory names, it is strongly recommended that recipients employ the same directories ("/TSU", etc.) as we at BPA do, as was explained in the preceding subsection. Note that the floppy disk is connected via "/FLOP", for which a name conflict is unlikely (if one exists, it will have to be removed by the recipient).

A minor qualification about GIVE1.COM might be made, even though the recipient should have no need to look at this file which created floppy disk number 1. In fact this is a file of commands, not a command procedure, since it can not be executed directly. Instead, what I do is edit the file, and copy (using MARK, COPY, and PASTE keys of the DN300 keyboard) the contents into the input pane of a window for execution. We tried to convert such commands into a command procedure, but had trouble with the user responses to \$INVOL. Adding "<<!" to the command worked fine down through the final question, at which point the "N" was somehow not read properly. Strange (if any reader has an explanation, and can modify GIVE1.COM so that it can be directly executed, we would be grateful to learn the error of our ways)!

Next come BENCHMARK DC-XX, DCNEW-XX, and DCPR-XX data cases. It is command procedures GIVE2.COM and GIVE3.COM which were used to create the second and third floppy disks, and the single command procedure RECEIVE2.COM which can be executed twice, to reverse the two operations (to copy from floppy disks numbered 2 and 3 to the Winchester). RECEIVE2.COM applies to both floppies, since it copies all available ".DAT" files:

```
$MTVOL F /FLOP
$LD /FLOP
$CPF /FLOP/%.DAT /TP -NQ
$DMTVOL F /FLOP
```

Apply this to floppy number 2 first, then to floppy number 3. Two floppies were required because of the enormous size of DC-1, which requires more than 1/4 of a megabyte. This explains why floppy number 2 contains all test cases except DC-1 and DC-11 through 19 (those picked up by the wild-card copy of /TP/DC1%.DAT).

Finally, there is the UTPF, which will be found on floppies numbered 4 onward (as of the "M38." vintage of February, 1984, four floppies were required for the 75K lines). Creation of the floppies was via GIVE4.COM, which relies upon the Aegis utility \$WBAK ("WRITE BACKUP -- Create a magnetic tape backup file"). Due to the importance of this command, I show GIVE4.COM.

```
$WBAK //A/UTPF/%.SPL.66 -F 1 -LF -DEV F
```

To reverse this operation, the recipient can use RECEIVE4.COM, which relies upon \$RBAK ("READ BACKUP" -- Restore or index a magnetic tape backup file).

```
$RBAK -F 1 -ALL -LF -DEV F -R
```

In that \$WBAK and \$RBAK usage is common, little explanation will be provided here. Read the SHELL COMMAND DESCRIPTIONS section of the Command Reference Manual. Just do not be misled by the continual reference to magnetic tape (we are using floppy disk, as requested by the "-DEV F" qualifier, which is not to be found in our documentation, for some strange reason!). I might also mention that "-F 1" refers to the first (and only) "file" being used, "-ALL" will copy all contents, "-LF" will show each file as it is copied (be prepared for 333 segments, for the "M38." UTPF of February, 1984), and "-R" will replace any existing files of the same names.

If Apollo users can provide a good explanation of the need, and an adequate number of floppies to store the associated files, we are generally willing to vary the contents of wild-card copies in GIVE4.COM. For example, we could add the executable Apollo EMTF version EMTF.EXE, or all compiler output (/TP/%.BIN), or the EMTF FORTRAN (/TP/%.FTN and /UTPF/%.INS.FTN). For those who do not work inside the program, just the EMTF FORTRAN might be adequate (warning: UTPF idents are missing, to save space!). But just the executable version EMTF.EXE should only be requested after considerable thought (remember that the PEB option creates a possible incompatibility). Give us a good reason, and we are willing to tailor GIVE4.COM to your special needs --- provided the correspondent supplies an adequate number of floppy disks to hold all materials of interest.

E. Translating, Compiling, and Binding the Apollo EMTP

Following the restoration of disk files using RECEIVE1.COM through RECEIVE4.COM as described in the preceding section, the recipient should produce Apollo EMTP FORTRAN by execution of the Apollo translator. After setting the directory to "/SCOTT", compile, bind, and execute the Apollo translator as follows;

```
$WD /SCOTT
$FTN APOLLOET -SAVE -B APOLLOET.BIN
$BIND APOLLOET.BIN -BINARY APOLLOET.BIN
$APOLLOET.COM
```

For our DN420 without PEB and with only half a megabyte, translation requires about 22 minutes, as of February, 1984. There will be one line of output for each overlay, so the user can monitor progress. The result will be EMTP INCLUDE files /UTPF/%.INS.FTN (about 30 in number), and massive chunks of EMTP FORTRAN in files /TP/MAIN00.FTN, OVER2.FTN, OVER8.FTN, OVER13.FTN, OVER20.FTN, OVER29.FTN, OVER43.FTN, and OVER51.FTN. The 75K lines of Apollo EMTP FORTRAN are split into these 8 nearly-equal pieces, for convenience of manipulation.

Next comes EMTP compilation, which requires only the execution of command procedure EMTPCOMPILE.COM. The variable-dimensioning program "VARDIM" must also be compiled, bound, and executed, and its NEWMODS.FTN output must also be compiled --- all by the command procedure /TSU/VARDIM.COM. Finally, the EMTP must be bound using EMTPBIND.COM:

```
$EMTPCOMPILE.COM
$/TSU/VARDIM.COM
$EMTPBIND.COM
```

The result will be /TP/EMTP.EXE, an executable version of the interactive Apollo EMTP. Compilation without the debugger (without the "-DBA" switch) requires about an hour and a quarter on a DN300, while BINDING may take five minutes. During this final step, all globals should be resolved, and there should be no error messages. Le voila!

F. TPPLOT.EXE --- Separate Vector-Graphic Plotting Program

Yes, via SPY, EMTP results can be plotted while the simulation is progressing, using the "PLOT" command. But comparable functionality is also available after an EMTP simulation has terminated, provided the user created and saved the plot file (provided integer miscellaneous data parameter ICAT was positive, and output frequency IPLOT was not negative). It is program "TPPLOT" which can be used for such later plotting, as described in Section 5.0 of the EMTP Rule Book.

Since recipients are generally supplied only with FORTRAN, compilation and BINDING will generally be required. The associated files are all obvious from the BINDING procedure, TPPLOT.COM.

```
BIND <<!
TPPLOTMOST.BIN FLATBD.BIN LINPLT.BIN
TEKPLT.BIN EXTRA.BIN -BINARY TPPLOT.EXE
```

For the preceding compilation of the five disk files TPPLOTMOST.FTN, FLATBD.FTN, LINPLT.FTN, TEKPLT.FTN, and EXTRA.FTN, I do nothing special other than use the "-SAVE" option (perhaps not required, but a good safety measure).

The default is for vector-graphic plotting, of course, and no special "SET DATA" usage should be required. Default settings provide for covering most of the screen with the fixed-size plot (the window should be full-height, and within an inch of full-width, to avoid having part of the plot hidden).

The initial prompt of "TPPLOT" is "OUTER.", corresponding to the request for keyboard data at the outermost of three levels of operation. The three levels are:

OUTER: ---- for specification of the disk file to be plotted, after which there will be an automatic transfer to the "MIDDLE:" level.

MIDDLE: --- for specification of the variables to be plotted, time units, and graph labeling.

INNER: ---- to produce another plot, perhaps varying the abscissa or ordinate scaling.

The functions indicated are those commonly used. In addition, there are many alternative, special requests. For a list of available commands at any level, and an abbreviated explanation of their function, send "HELP" at the level of interest. Also, to transfer among levels manually, use "OUT" or "IN".

Until I learn how to control "page skips" at the beginning and the end of a plot, users of TPPLOT.EXE must put up with these inconveniences. There will be such a skip at the beginning (no remedy here); but at the end, I chose to inhibit the page skip by means of a READ from the keyboard. This holds the plot on the screen. If and when the user hits the RETURN key, the plot will rapidly be rolled upward (the undesirable page skip), and the familiar "INNER." prompt should appear.

The fundamental, original data required of the user is a disk file name, which should be associated with an EMTF plot file. Provided the day, month, and year have not changed, the user need only send the six digits of the time (HHMMSS), and "TPPLOT" will append the rest. Since most plotting is done on the same day as the simulation (EMTF users are in a hurry, and Apollo provides instant gratification!), the use of such abbreviated file specification greatly simplifies the burden of keying, and minimizes mistakes.

Originally, EMTF plot file names just used the six digits from the time: PLOTHMMSS.PL4. But during late 1983, the Apollo EMTF was modified to add six more digits, from the date: PLOTMMDDYHHMMSS.PL4. This is the only change affecting compatibility of new and old versions and files. If TPPLOT.EXE rejects the user's abbreviated plot file name at the "OUTER:" level, it might be wise to try the full disk-file name (all 20 characters, for current versions).

For those wanting to test "TPPLOT" using a standard, controlled file of plot points, try "HHMMSS" literally as a specification of the disk file at the "OUTER." level. The recipient of Apollo EMTF materials on a floppy disk will receive the FORTRAN file /SCOTT/PLOTDAT.FTN, which need only be compiled, bound, and executed. The result will be a special disk file /SCOTT/PLOTHMMSS.PL4, which enjoys a special connection with the "HHMMSS" request (note that the current six digits of the date are not appended).

G. Use of Remaining Apollo EMTF Support Software

Programming is done via copies of the UTPF segments /UTPF/%.SPL.66 --- copies which are placed in Tsu-huei's directory "/TSU", and which are distinguished from one another by file type. One set of files are ".PUM" (e.g., /TSU/OVER1.PUM), another are ".QUM", etc. --- with as many different file types as there are parallel program developments to be separated. This is for minor-update usage, which will be explained in the remainder of the present section. For all such work, the working directory should be set to "/TSU".

Consider first the convention for indicating those UTPF records which have been changed. In order to interface with "GENCOR" (to be described later), the UTPF ident of each altered (or moved) line must be blanked out. True, functioning of the minor update itself does not depend upon this, and corrections could later be summarized using the standard Apollo file-comparison utility \$CMF. But to agree with standard EMTF programming practice of more than five years with the VAX, altered records should have columns 1-8 blanked.

Suppose that the user has been making changes to his copies of UTPF segments which are assumed to be stored as /TSU/%.PUM files. Provided he has been blanking columns 1-8 as just described, UTPF-update correction records are generated by issuing the shell command "\$GENCOR PUM", which will produce correction segments /TSU/%.COR. An example of such usage follows:

```
$ GENCOR PUM
LD /TSU/%.PUM -A >DIRMUP.LIS
//A/SCOTT/LISTMAKER.BIN <<!
Fortran STOP
//A/SCOTT/GENCOR.BIN <<!
Completion of "datain". KKA = 1 REC = 3 KTRTOT = 0
Completion of "dekspy". KKA = 2 REC = 6 KTRTOT = 0
Completion of "initsp". KKA = 3 REC = 2 KTRTOT = 0
Fortran STOP
```

Note that three modified UTPF segments are involved, and that there is one line of output for each, as the execution of "GENCOR" continues. The "REC=" figure shows the number of UTPF-update correction records which have been produced for the segment in question, and "KTRTOT = 0" is an indication of no trouble (mnemonically, "K TRouble TOTal," where "K" is an integer counter). If any value other than zero is ever seen, the user should stop immediately (CTRL-Q), and investigate the segment for which a non-zero value was first produced, since either that modified UTPF segment, or the associated reference UTPF segment (".SPL.66") is somehow in error. To illustrate the format of the UTPF-update correction records, let me display part of a corrections file /TSU/OVER1.COR which was produced during the major update of 10 March 1984:

```
*I M37.1057      63      OVER1
                IOFGND = 0 ! LESS THAN 80-COL MARTI CARDS OK IN "SUBR39"
*D M31. 198      71      OVER1
*D M32. 672     218     OVER1
```

2 LFDEP, LWT, LTAILS, LIMASS, LSYN, MAXPE, LTACST, LFSEM, LFD,
First, one sees the insertion of one new record (IOFGND = 0), after line number 63 of the UTPF segment "OVER1" (which has UTPF ident "M37.1057"). Next, there is the deletion of line number 71 (which carried UTPF ident "M31.198"). Finally, there is the modification of line number 218 (UTPF ident "M32.672"). The only missing structure in this illustration is that of a block deletion and multiple insertion, such as the following example (from "CSUP" of the same major update):

```
*D M28. 600,M28. 601      509, 510      CSUP
                3 E13.4, 46H SEC. USE DEVICE TYPE 53 INSTEAD OF TYPE 54 . ./,
                4 21X, 50H ***** THE ANSWER MAY BE WRONG LATER ***** )
```

The importance of such UTPF-update correction records can not be overemphasized, since they form the basis of major updates and production updates of the program (not to be described here). If a user wants to communicate program changes to us in Portland, it is the correction files %.COR which should be sent, since they can immediately be incorporated without modification. The procedure is both compact and automated.

On to the minor-update procedure --- the creation of a modified EMTF which corresponds to a set of modified UTPF segments. Command procedures are

used for minor updates, with a pair for each file type which is used to distinguish sets of correction files (".PUM", ".QUM", etc.). I will illustrate just \$PUM1 and \$PUM2, the shell commands in Tsu-huei's directory ("/TSU") which will produce a minor update corresponding to modified UTPF segments /TSU/%.PUM. If the user sends these two commands in order, in effect he will be ordering:

```
LD /TSU/%.PUM -A >DIRNAME96
/SCOTT/TPUPDATE.BIN <<!
    0 96 IPRSUP(I5), VERS (3X, A2)
!
/SCOTT/APOLLOET.BIN <<!
.PUM          96      0      0      8      4      0/M35/
ENDMOD
!
FTN MINOROUT96 -SAVE -B MINOROUT96.BIN
BIND <<!
//A/TSU/NEWMODS.BIN MINOROUT96.BIN //A/M35/BLOCKDSPY.BIN
//A/M35/APOLLOMODS00.BIN //A/M35/APOLLOMODSNON00.BIN
//A/M35/CIMAGE.BIN //A/M35/CALCOMP.BIN //A/M35/TEKPLTPLUS.BIN
//A/M35/MAIN00.BIN //A/M35/OVER2.BIN //A/M35/OVER8.BIN
//A/M35/OVER13.BIN //A/M35/OVER20.BIN //A/M35/OVER29.BIN
//A/M35/OVER43.BIN //A/M35/OVER51.BIN
-BINARY EMTTPUM.EXE
-END
!
```

In fact, my preference was for just one such command procedure. However, for some not-yet-understood reason, execution would terminate upon completion of "APOLLOET" (the compilation of MINOROUT96.FTN never occurred). So, the single, original command procedure was split in two, and now execution proceeds without difficulty. If and when we learn what I am doing wrong, the two will probably be combined into the single minor-update command "\$PUM".

It is important to note that there will be multiply-defined modules for each and every SUBROUTINE or FUNCTION involved in the update. This is the price we pay for the simplicity and speed of Apollo minor updates. The message should always refer to one of the /M35/OVER%.BIN files, since it is the major-update module of such files which is seen second, and therefore is discarded by the BINDER. For example, if only "OVER16" were modified (suppose OVER16.PUM were the only ".PUM" file), then the execution of "\$PUM2" should appear as follows:

```
FTN MINOROUT96 -SAVE -B MINOROUT96.BIN
no errors, no warnings in OVER16, Fortran version 5.55 ...
BIND <<!
?(bind) Warning: OVER16 Multiply Defined Global
      Input file "//A/M35/OVER13.BIN"
All Globals are resolved.
No Errors; 1 Warning.
```

The reference to "OVER13" is correct, since "OVER16" follows this module, but precedes "OVER20" (which begins the following disk file of the segmented EMTF FORTRAN). Note that the resulting, modified, executable EMTF is /TSU/EMTTPUM.EXE, and this can be used just as EMTF.EXE otherwise would be.

Note that a number of executable programs have been referred to, although none are distributed on the standard floppy disks of Section D. It is the recipient's responsibility to compile and BIND the associated FORTRAN, creating executable versions. For example, consider the translator. The user will receive /SCOTT/APOLLOET.FTN, so after setting the working directory to "/SCOTT", the following two operations will produce the desired executable translator:

```
$FTN APOLLOET -SAVE -B APOLLOET.BIN
$BIND APOLLOET.BIN -BINARY APOLLOET.BIN
```

Corresponding steps apply to all other executable programs which are required by the command procedures. Whether renaming the binary in each of these two commands is really necessary, I am not sure. It is simply a case of my remembering trouble long ago when I did not do this for files of two or more SUBROUTINES, and wanting to avoid any such problems here.

H. Use of Apollo Symbolic Debugger on the EMT

The Apollo Symbolic Debugger DEBUG allows the EMT user to suspend program execution at any line of the EMT.FORTRAN, and examine or change any accessible variables (e.g., all local variables and COMMON variables present in the module under consideration). This is a very powerful diagnostic tool in case of trouble, so the Apollo EMT user should be familiar with its use. Details are fully described in a separate Apollo manual of some 100 to 200 pages entitled "Language Level Debugger Manual" (the one I am now looking at is for SR6.0).

While I can not begin to duplicate the detail of the Apollo manual, it might be valuable just to outline a few of the basic commands. First, EMT execution is begun as follows:

```
$DEBUG /TP/EMT.EXE
```

As of March 1984, this requires about two minutes on either our DN300 or DN420 (each with 1.0 Mbyte of memory, and no PEB). After such a short wait, the top half of the window being used will automatically be taken over by another window with an input pane for all DEBUG commands. Then, if execution were to be suspended at S.N. 3472 of "OVER5", the following would be keyed after the ">" prompt in the new DEBUG pane:

```
B OVER5\#3472
G
```

Note the backslash here (a common error of beginners is to use the normal forward slash "/" instead, and then wonder why DEBUG rejects the command as having an unknown label). The pounds sign precedes a statement number (without such a mark, the number 3472 would be interpreted as a line number). The "G" is the command to "go" (continue EMT execution). To examine variables, use the "E" command (e.g., ">E NCHAIN"); to step from the present line to the next executed line, send "ST". Finally, to stop EMT execution via DEBUG, send "Q" (the short form of "QUIT").

Yet EMT users have a special problem, due to program size. For the "M38." version of 27 February 1984, \$DEBUG would not function for the entire program dimensioned at three times default, and with only OVER2.FTN compiled using the "-DBA" switch (debugger "on"). But dropping OVER51.BIN from the BIND command of /SCOTT/EMTPBIND.COM reduced the burden enough so that DEBUG operation was possible. This was using the SR7.0 operating system and an advanced compiler (vintage 5.69, which preceded the SR7.1 system update). Correction! With the installation of SR7.1, a test performed on 31 March 1984 showed that the missing OVER51.BIN could be added without difficulty. So, the good news is that size has been expanded a little. But how much? An attempt to add "-DBA" usage for OVER13.FTN (overlays 13, 14, 15, and 16) failed (Aegis complained about "not enough address space for static storage", when execution via "\$DEBUG" was attempted). Using these crude numbers, and remembering that each segment of EMT FORTRAN averages close to 10K lines, it would appear that "-DBA" can be used with a maximum of somewhere between 10K and 20K lines of EMT FORTRAN, without any program segmentation. With segmentation (e.g., dropping OVER51.BIN), greater capacity should be possible, but I will leave this experiment to others.

APOLLO APOLLO APOLLO APOLLO APOLLO

I. Peculiarities of Non-SPY Apollo Installation-Dependent Modules

Installation-dependent Apollo EMTF modules which affect interactive EMTF use (SPY) have already been described in subsection B. To complete the job in the present subsection, then, only peculiar details of non-SPY Apollo modules will be added.

"RANDNM". Because Apollo FORTRAN does not seem to offer a random number generator along with other library functions as most other computer systems do, the generation of random switch closing times for Monte Carlo ("STATISTICS") studies poses a minor problem. For lack of anything better, we have adopted logic which dates back to the IBM System/360 Scientific Subroutine Package, according to a letter dated 20 June 1983 from Willie Magoon of Electrocon International (Ann Arbor, Michigan). See Ref. 8, Vol. XIII, 27 May 1983, Section IV-G, bottom of page POAD-32. The Electrocon structure has been modified (SUBROUTINE RANDU was eliminated, SAVE is used instead of COMMON, etc.), but the mathematics of 32-bit INTEGER overflow should be unaltered. Because so much time can be absorbed by Monte Carlo studies, any uses should be sure that he is satisfied with Apollo EMTF random numbers before relying upon them for engineering studies. To aid such consideration, I reproduce critical non-comment portions of the module as it existed on April 2, 1984:

```

FUNCTION RANDNM ( X )
  IMPLICIT REAL*8 (A-H, O-Z), INTEGER*4 (I-N)
%INCLUDE '//A/UTPF/BLKCOM.INS.FTN'
  SAVE
  IF ( XMAXMX .LT. 0.0 ) GO TO 7265
  IF ( X .EQ. 0.0 ) GO TO 2563
  IF ( KNT .GT. 1 ) GO TO 9800 { ONLY USE
  IRANX = X { "FIX" THE INPUT SEED (LARGE RA
  IF ( IRANX/2*2 .EQ. IRANX ) IRANX = IRANX +
2563 IRANY = IRANX * 65539
  IF ( IRANY .LT. 0 ) IRANY = IRANY + 2147483
  D15 = IRANY
  RANDNM = D15 * 0.4656613E-9
2568 IRANX = IRANY
  GO TO 9800
7265 RANDNM = SANDNM ( X )
9800 RETURN

```

J. Using Apollo \$EMT Command to Pass Files to VAX

In theory, the passing of files between Apollo and VAX via an RS-232 line is trivial. But in practice, it has not always been so easy. Tips which should allow the VAX user to avoid a considerable portion of our own trials and errors follow.

First, consider the passing of files from VAX to Apollo. Begin by establishing the physical connection, if one does not exist (no problem for our DN420, which has a VAX line permanently connected to the 2nd RS-232 Apollo port). Then, in an Apollo window, activate the communication by sending "\$EMT", followed by "RAW", "LINE 2", and "TERM VAX" (the latter three in response to the EMTF prompt ">"). The opening of the Apollo disk file is then via a command ">RCV FILE_NAME -R", where the extra "-R" will overwrite any existing file of the same name. Then push the F1 key to switch to the VAX side,

and log in, if necessary. It is always a good idea to send some trivial VAX/VMS command like "\$SHOW TIME", to be sure VAX/VMS is listening. Usually, the VAX/VMS prompt "\$" will not be seen, for some reason. Once the communication with VAX/VMS is proven, initiate the file transfer by a "\$TYPE" command. After a few records have begun to fill the window, press the F3 key, to turn off such monitoring. If the file is big (e.g., the 75K-card UTPF), it is prudent to press the F3 key from time to time, just to be sure the transmission is continuing. When finally nothing is seen, this is taken as an indication that the transmission is complete. Pushing the F1 key returns to the Apollo side, at which point the "CLOSE" command will finish the Apollo storage. Then the file should be edited, to delete the irrelevant records at the top, and to add the missing column number one of the first record of the VAX file.

The only general complication with the just-described procedure is that a carriage-control character (column 1) may be lost, if attributes of the VAX file storage are not correct. If the file has been created using the SOS editor, then there is no such loss. On the other hand, if a VAX FORTRAN program creates the file (e.g., CUTUTPF.EXE, which segments the UTPF following a production update), this always seems to create files from which column one will be stripped by the VAX/VMS "\$TYPE" command. This represents no real problem, once one knows the rule, and takes it into account. For those files which will lose column one, we add an extra, blank column one, creating 81-column images prior to the transmission. This is via CARRIAGE.EXE, which uses FOR021 as input and FOR022 as output (assigned externally by the user).

It is the passing of files from Apollo to VAX which created considerable trouble for us, for over a year. It was only in early April of 1984 that we learned the error of our ways, thanks to a suggestion from Ken Strong of the local Portland office of Apollo. Ken supplied the TCTL command of the procedure which will follow, thereby synchronizing the transmission. Without TCTL usage, we found that the file creation by VAX/VMS apparently would randomly terminate, aborting the reception (VAX/VMS would then reject subsequent lines one at a time, with an error message). So, a tip of the EMTP hat to Ken Strong, without whose help the passing of multi-megabyte BPA power flow files from Apollo to VAX would not have been possible.

As for the mechanics of passing a file from Apollo to VAX, the initiation is similar to that just described. Only instead of RCV, immediately toggle F1 to switch to the VAX side, and issue the VAX/VMS command "\$CREATE VAX_FILE_NAME" (where VAX_FILE_NAME is any legal VAX/VMS file name into which the Apollo file is to be copied). Press F1 a second time, and respond to the EMT prompt ">" with "XMIT APOLLO_FILE_NAME". Finally, press F1 a third time, and watch the file being transferred. When the transmission ceases, CTRL-Z will close the VAX/VMS file, and the process is complete.

Yet two problems with the preceding Apollo-to-VAX transmission remain. First, there is echoing (each line appears twice). Second, the F3 key does not turn off the monitoring of the transmission, unfortunately. If any reader knows how to eliminate these two effects, we in Portland would appreciate being informed of the error of our ways.

K. 2800-Bus Apollo BPA Power (Load) Flow Program

Although it has nothing to do with the EMTP, I am making known the availability of a 2800-bus BPA Power Flow program for Apollo, too. This program is the backbone of System Planning, and it corresponds to what most refer to as a "load flow" program. It is true that loads do not flow, but then neither does power (I maintain that BPA naming is not only non-standard, but also equally illogical, since power is the flow of energy)! Be that as it may, most parties who have interest in the Apollo EMTP will also have interest in the Apollo BPA Power Flow program, so this unifies the information, and saves a second request. For those who send an adequate number of floppy disks, Apollo Power Flow FORTRAN will be supplied automatically along with the EMTP.

No special adaptation of the BPA Power Flow has yet been made, in order to accommodate the special features of Apollo. This is because Apollo is not yet being used for production Power Flow studies by System Planning personnel, as of April, 1984. Specifically, there is no special graphical output of the Power Flow, and no new interactive control or adjustment options. The program remains the same basic batch-mode program as is used for production purposes on BPA's VAX-11/780.

During April of 1984, Walter Powell (the BPA Power Flow programming guru) regenerated a current version of BPA Power Flow FORTRAN, and passed the result from VAX to Apollo. The source is maintained on VAX1, and the "version switch" (about which I know no details) was set to produce Apollo output rather than VAX output (there would seem to be "either/or" choices at various installation-dependent locations of the source code. While this is not "machine translation" in the EMTP sense, it does effectively account for differences required by the two computers which are of interest for the Power Flow at BPA. Following a rather uneventful set up, and subsequent program changes to gain space (permitting larger dimensions within the Apollo 24-bit addressing limitation), Walter performed some testing with realistic production cases up to 2500 or 2600 busses.

Walter's timing tests using realistic production studies reveal outstanding performance for our Apollo DN420 with 1.0 MByte of memory and a PEB. Relative to VAX, the Power Flow seems even better suited to Apollo than does the EMTP. If average Apollo performance for the EMTP might be a quarter of a VAX-11/780, the corresponding average Power Flow ratio seems to be around a third. Walter's most favorable ratio was for WSCC base case number 84J4001 --- a solution which involved 1727 buses, full printed output (501 line printer pages), no microfiche output, no saved base case, and which solved in 13 iterations. For this case, the Apollo-to-VAX CPU ratio was 2.3, whereas 2.4 is the corresponding wall-clock ratio.

Walter was kind enough to write a page of instructions for use of his Apollo BPA Power Flow materials. This file, //A/WLP/PF_USERS_INSTRUCTIONS, will be copied into the present file to ensure that it will not be lost and/or overlooked. The most recent date is 29 April 1984. Walter:

This guide summarizes the steps required to install BPA's Powerflow program on the Apollo.

1. Copy the following files from directory /WLP/:
 - a. All "include" decks, i.e., the %.INS.FTN modules.
 - b. All Fortran decks, i.e. the %.FTN modules.
 - c. A compilation command procedure: PFCOMPILE.COM.
 - d. A binding procedure: PFBIND.COM.
 - e. A small sample test deck, complete with non-fatal errors: TESTDC.DAT. The solution is TESTDC.LST
2. Most of the dimensions are parameterized. They are either fixed or expressed as a function of three major attributes: the number of buses (NUMBUS), the number of REI subsystems which can be created during a network reduction (MAXREI), and the number of changes (MAXCHG). They are defined in PARAMS.INS.FTN. Their current values are 2800 buses and 1000 changes.
3. Compile the relevant modules using the -SAVE option. If possible, include these options: -PEB, -OPT, -NDB. A command file PFCOMPILE.COM has been prepared for this.
4. Bind the relevant modules. Modules PWRFLO and its associated block data BLKDTA are the main ones. A command file PFBIND.COM has been prepared to create the executable image PF.EXE. To conserve memory, some of the modules have been replaced with stubby modules. Two major features - network reduction and base merging - have been disabled to permit the powerflow program to fit within Apollo's physical memory.
5. Create a command/data file for Powerflow execution. The file TESTDC.DAT is available for testing. The file consists of approximately 20 buses, but tests isolated systems, multi-terminal dc, area interchange, phase shifters within line sections, and (for good measure) a few non fatal errors.
6. Execute the PF program by the command \$PF.EXE. It is interactive, and will prompt with the message:

```
Enter Program control file name >
Enter the name of the command file ("TESTDC.DAT")
described in item 5 above.
```

Three output files are automatically assigned from the name of the input command file. For the particular file TESTDC.DAT, the output files will be:

- a. Printed output - TESTDC.PFO
- b. Debug output - TESTDC.PFD
- c. Microfiche output - TESTDC.PFF

Walter L. Powell
24 April 1984

Distribution of the Apollo Power Flow materials on floppy disks will be handled using only one special command procedure, which will communicate all program FORTRAN (including the 129 or so INCLUDE files). To minimize wasted space and manual intervention, \$WBAK will be used, as the following view of //A/SCOTT/PFGIVE.COM shows:

```
WBAK //A/WLP/%.INS.FTN -F 1 -LF -DEV F
```

WBAK //A/WLP/%.FTN -F 2 -LF -DEV F
 Associated Power Flow test data will be limited to two small problems: one of 20 busses, and the other of 306 busses. While the first of these is purely imaginary, it is very general, including "one of everything" (including two slack busses of subsystems which are connected by a dc link). The second is a fairly realistic representation of the core system of the Pacific Northwest some 20 years (when computers were much slower and weaker, and the standard BPA Power Flow was dimensioned 500 busses!). These two data sets will be appended to the 3rd EMTF floppy disk (files /WLP/TESTDC.DAT and /WLP/TEST306.DAT), in order to maintain the separation of FORTRAN and data. Also on the 3rd EMTF floppy disk are the compilation and binding command procedures for the Power Flow (PFCOMPILE.COM and PFBIND.COM, respectively), and the solution to TESTDC.DAT (disk file TESTDC.LST includes both the output to the window and the line printer file TESTDC.PFD, which total less than 600 lines).

L. Miscellaneous Last-Minute Comments and Observations

As of 28 February 1984, the compilation of /TP/OVER2.FTN requires the use of a prototype compiler such as FTN 5.69, since standard Rev 7 software will abort. Wayne Rommel of the Seattle office of Apollo provided us with this temporary remedy. Then, on March 13th, having tried the compiler of the brand new Apollo software release SR7.1 at the local Apollo office, I can report that "-DBA" is still required, but that at least no special compiler is needed any longer.

As of the end of February, 1984, Apollo PRINTER PLOTS may be missing lines containing no data points. Yes, this can and will be fixed, eventually, but with vector plotting, who wants PRINTER PLOTS, anyway? The logic of installation-dependent "LINPLT" of APOLLOMODSNON00.FTN is simply defective, due to special requirements for mimicing the "1H+" carriage-control.

EMTF table dumping and restoring deserves further work. Here I am referring to the installation-dependent SUBROUTINE TABLES (produced by the variable-dimensioning program "VARDIM"), which is used by Monte Carlo simulations, as well as by the "SAVE" and "RESTORE" commands of SPY. During conventional simulations, the following short messages will be seen between connectivity and the phasor branch flows (the following is from DC4):

```

TOP "TAPSAV". NCHAIN = 6
TOP "TAPSAV". NCHAIN = 8
PI-EQUIV BRANCHES OF DISTRIB LINES IN TR, TX, ....
NONLINEAR AND TIME-VARYING RESISTANCES IGNORED ....
TOP "TAPSAV". NCHAIN = 8

```

In fact, no "LABCOM" dumping is occurring. But not so for "STATISTICS" data cases, which presently use unformatted READS and/or WRITES to disk --- one per COMMON block. This is not the fastest.

0.6 User-Controlled.Variable Dimensioning of the EMTP

The EMTP stores most problem data (exceptions are the S.M. of Sect. 1.62 and ZnO of Sect. 1.32) in tables which can be sized by the user at linkage-editing (loading; linking; etc.) time. The basic procedure was originally detailed in Ref. 8, Vol. II, 30 January 1975, pagination VARD and 17 April 1975, pagination RSFU. For the user's benefit, key points that are independent of computer system shall now be summarized. The user is also referred to the installation-dependent instructions for his computer system (Section 0.5a onward), since various aspects of the procedure depend upon both the brand of computer and the organizational usage. But universal aspects are:

Point 1 : With only a few relatively minor exceptions, the user can size all EMTP tables at will. There are currently 27 independent tables (or "lists") in the program, as per the following definitions:

- List 1 : LBUS ---- The maximum number of problem nodes (busses).
- List 2 : LBRNCH ---- The maximum number of problem branches. A 3-phase overhead line counts as three, etc.
- List 3 : LDATA ---- The maximum number of R, L, C floating-point parameter values which are read from branch cards (such as for Pi-circuits and series R-L-C branches).
- List 4 : LEXCT ---- The maximum number of problem sources. Each dynamic S.M. (see List 17) contributes 3.
- List 5 : LYMAT ---- Limit on floating-point storage for both the admittance matrix [Y] of the time-step loop (both upper and lower triangle are stored) and also its factors (upper-triangle only). Both are stored simultaneously.
- List 6 : LSWTCH ---- The maximum number of problem switches. Diodes and valves also count as switches.
- List 7 : LSIZE7 ---- Total number of distinct 6-character (A6) ALPHANUMERIC names that are used by the program. As of April, 1984, it is only TACS and the Type-59 S.M. which use this new storage principle. Later, perhaps electric network tables will be converted (it saves memory and simplifies SPY displays).
- List 8 : LPAST ---- The maximum number of modal past-history points, for distributed-parameter transmission lines.
- List 9 : LNONL ---- The maximum number of nonlinear and pseudo-nonlinear elements in the problem.

- List 10: LCHAR ----- Maximum number of points that define the characteristics of the nonlinear or pseudo-nonlinear elements of List 9 . Type-96 hysteretic inductors are an exception, however. For the first such element, $2*N + 8$ cells are allocated, where N is the number of data cards that define the characteristic. Second and later elements might use the reference-branch feature, in which case requirements drop to six cells. See Section 1.31 for further details of this exceptional case.
- NOTE: If there are ZnO surge arresters in the case, extra cells are needed. The burden of each arrester is equal to the number of segments (exponentials) that require representation.
- List 11: LSMOUT ---- The maximum number of Type-59 synchronous machine (S.M.) outputs.
- List 12: LSIZ12 ---- The maximum number of output quantities.
- List 13: LFDEP ---- The maximum number of frequency-dependent modes of distributed-parameter transmission lines which use the "WEIGHTING" modeling of Section 1.26b .
- List 14: LWT ----- The maximum number of cells required to store frequency-dependent weighting functions A1 and A2 for the modes of List 13 .
- List 15: LTAILS ---- The maximum number of cells needed to store the convolution line history for the exponential tails of frequency-dependent weighting functions of List 14 .
- List 16: LIMASS ---- The maximum total number of masses of all Type-59 S.M. usage (total over all machines).
- List 17: LSYN ----- The maximum number of Type-59 synchronous machines (S.M. components) of Section 1.62
- List 18: MAXPE ---- The maximum number of branch or switch power and energy requests (column 80 punches having a value of "4").
- List 19: LTACST ----- Maximum number of floating-point cells of total storage for all of the TACS tables. See Section 8. . A value of 23 is the minimum allowed (any small value will be so increased). A reasonable practical minimum for production problems might be 2000 . Serious TACS users will probably want more.

- List 20: LFSEM ---- Storage for frequency-dependent lines which rely upon recursive convolution. For Marti modeling (Sect. 1.26b1), any branch requires: $5 + 7 * \text{the number of poles used to represent the two functions } Z_0 \text{ and } A_1$. For Semlyen modeling (Sect. 1.27), each branch requires one cell, plus five times the number of poles of the propagation functions, plus four times the number of poles of the admittance functions.
- List 21: LFD ----- The maximum number of cells used to store transformation matrices for the constant-parameter and frequency-dependent distributed transmission line models. For each non-copied line section of "N" phases, $2 \times N \times N$ cells are required.
- List 22: LHIST ---- For each Marti line, 15 cells are required for each coupled phase. For each Semlyen line, it is the larger of six times the number of coupled phases and two times the number of poles used for both functions (propagation & characteristic admittance) which is required.
- List 23: LSI23 ---- Ignore for all non-virtual computer systems (CDC, Univac, Honeywell), and also for all computer systems which use overlaying (presently IBM, Harris, etc.) --- unless the EMTP load flow ("FIX SOURCE") is used. But for fully-virtual systems not short of address space, and for computer systems where COMMON blocks are not in order, this list is required. It specifies the size in floating-point words of three giant vectors which are used for node renumbering and the phasor steady-state solution. As of the end of 1981, this list is used for Burroughs, PRIME, VAX, Data General, and Apollo EMTP versions. Default is 4000.
- List 24: NCOMP ----- Maximum number of phases of compensation, at peak problem size. The actual maximum number of phases then varies inversely with the number of problem nodes. Use of NCOMP = 3 is most common, allowing for 3-phase compensation with full-size problems, 6-phase compensation with half-size problems, etc.
- List 25: LSPCUM ---- Maximum number of floating-point cells of total storage for all universal machine (U.M.) tables. If U.M. modeling of Section 1.63 is not of interest, set to unity. Practical production usage allowing two 3-phase induction machines typically takes LSPCUM = 1500 .

List 26: LSI226 ---- Length of working vectors in /BLANK/ which are used for various things in the EMTP. Originally fixed at 50 cells, these are now variably-dimensioned to allow open-ended usage (e.g., more coupled phases). See Ref. 8, Vol. XI, 18 Oct 1981, SSIA-12.

List 27: LSI227 ---- Reserved for possible later use with frequency-dependent sources (Ref. 35). But for now, it is used only to store steady-state node voltage outputs. Size should equal List 11, then, not unity.

An abbreviated version of this explanation appears as part of the case-summary statistics which complete the line-printer output of each data case being solved. See the example of Section 2.3 .

Point 2 : One step in the dimension-changing process is the execution of a separate variable-dimensioning program named "VARDIM" . This program reads 3 data cards in 10I8 format, obtaining therefrom the user-specified list sizes. The format for these 3 cards is as follows:

1	2	3	4	5	6	7	8	9	10
LBUS	LBRNCH	LDATA	LEXCT	LYMAT	LSWTC	LSMAT	LPAST	LNONL	LCHAR
I8	I8	I8	I8	I8	I8	I8	I8	I8	I8

11	12	13	14	15	16	17	18	19	20
LSMOUT	LSIZ12	LFDEP	LWT	LTAILS	LIMASS	LSYN	MAXPE	LTACST	LFSEM
I8	I8	I8	I8	I8	I8	I8	I8	I8	I8

21	22	23	24	25	26	27
LFD	LHIST	LSIZ23	NCOMP	LSPCUM	LSIZ26	LSIZ27
I8	I8	I8	I8	I8	I8	I8

Point 3 : As immediate verification of the list sizes applicable to any given EMTP simulation, the introductory heading which starts each new case displays such figures. For example, (see next page)

ELECTROMAGNETIC TRANSIENTS PROGRAM (EMTP), DIGITAL (DEC) VAX-11/780 TRANSLATION AS USED BY BPA IN PORTLAND, OREGON 97200, USA.
 DATE (MM/DD/YY) AND TIME OF DAY (HH,MM,SS.) = 04/06/82 11.05.56 VAX/VMS PLOT FILE = 406110556.PL4
 FOR INFORMATION, CONSULT THE 746-PAGE EMTP RULE BOOK DATED SEPTEMBER, 1980. PROGRAM VERSION = "M31."
 INDEPENDENT LIST LIMITS FOLLOW. TOTAL LENGTH OF /LABEL/ EQUALS 184820 INTEGER WORDS. 703 1050 2500 40 9500
 .46 6300 1000 100 400 200 140 20 1000 400 15 4 100 20000 200 900 300 20000 6 700 500

DESCRIPTIVE INTERPRETATION OF NEW-CASE INPUT DATA | INPUT DATA CARD IMAGES PRINTED BELOW, ALL 80 COLUMNS, CHARACTER BY CHARACTER.

0	1	2	3	4	5	6	7	8
0	0	0	0	0	0	0	0	0

MARKER CARD PRECEDING NEW DATA CASE. | BEGIN NEW DATA CASE

Also shown in this printout is a figure for the total number of words of labeled common (abbreviated as "/LABEL/") storage, which is the total storage requirement for all of the EMTP tables during the solution phases of the program. This figure will generally be needed by Program Maintenance should a computer system error occur during the execution (at which point the system rather than the EMTP will terminate execution), and the EMTP experts are forced to dig into the FORTRAN listing to find where execution stopped.

Point 4 : The "cost" of variable-dimensioning of the EMTP is a constant, pre-execution overhead which consists principally of the cost of loading (called linkage-editing, on IBM) the previously-compiled FORTRAN code. Once this operation has been performed, execution of the redimensioned EMTP will proceed at essentially the same speed as would a fixed-dimension program; there is negligible penalty during the actual solution phase of a typical EMTP data case.

Exceptions are the TACS code of Section 8. (which also uses offset-subscripting), and the universal machine (U.M.) code of Section 1.63 (which also assigns working locations for arrays as arguments of SUBROUTINE calls).

Point 5 : Certain primary-level non-solution overlays have giant working arrays (a maximum of one per overlay) which are sized the same as /LABEL/ except for a possible built-in offset which very crudely adjusts for the amount of code of the overlay. If the user wants to manually apply an additional offset to this storage, he can add a fourth data card as follows:

1. Punch an extra "9" in column one of the first data card that is read by VARDIM. This is taken as a special flag (VARDIM extracts it from LBUS before LBUS is used).
2. Add a fourth data card containing the extra desired offsets. The format is 10I8, with one data field for each such primary-level non-solution overlay. Currently there are eight: OVER29, OVER31, OVER39, OVER43, OVER44, OVER45, OVER47, and OVER48.

Common usage of this feature is for virtual machines, where enormous list sizes are requested; unless specially compensated for, the giant working arrays would be dimensioned far beyond any reasonable program needs. In this case, offsets will all be negative. We do this on the VAX, where in March of 1980, offsets of -128500 are being used for the five overlays. For the record, the size of /LABEL/ is 207363 integer words, or in excess of 3/4 MB! Using the negative offsets saves on virtual address space for us, that's all.

Note that the tabulation not only includes a total-multiplicity figure (bottom row of the table), but also decomposes this into integer and floating-point components. Such a distinction is important when working with a program version in which integer words are not as long as are floating-point words (e.g., the common double-precision IBM translation, wherein integer words are 32 bits (INTEGER*4), and floating-point words are 64 bits (REAL*8)).

Example: Suppose that a user wanted to increase list 11 and decrease list number 2, all the while maintaining constant memory allocation.

- a) On CDC where integers and floating-point words are of equal length (both 60 bits), the "TOTAL" row of the table shows that:

$$L_{11} \cdot 4 + L_2 \cdot 8 = 0$$

where L_k is the increase in size of list k .

- b) For the most common case on IBM, with 4-byte integers and 8-byte reals,

$$L_{11} \cdot (1 + 3/2) + L_2 \cdot (3 + 5/2) = 0$$

Note that the multiplicity from the row marked "FLOATING PT." has here been used unchanged, while that from the row "INTEGER" has been divided by two in order to reflect their relative length of a half a floating-point word.

As to how large a computer memory partition is actually required for the execution of any particular program version ---- or perhaps more appropriately, how much memory space is actually unused when a given standard memory partition of the computer is used ---- the user should see a Program Maintenance expert. From the size of /LABEL/ as found in the heading printout which begins each new data case which is being solved (see Point 3), and a memory map for the standard EMTP version which has all default dimensions, the question is readily answered. The required partition size depends directly, and only, on the size of /LABEL/, of course.

0.7 FORTRAN Data Format Specifications

Throughout this manual, data formats are indicated in FORTRAN notation, with symbols like F10.3, I8, A6, or E10.3. A short, illustrative explanation is as follows. If unclear or incomplete, refer to a FORTRAN manual.

F10.3 ~ A decimal number is to be inserted in this space (field) of width 10 columns. In general, you should punch a decimal point; if you do not, it is assumed that digits in the last 3 of the 10 positions are to the right of the decimal point. As long as you punch the decimal point, the "3" is overridden, and positioning within the field is immaterial. Examples follow:

-39.5	~	gives	132.745
132745	~	gives	132.745
3.14159	~	gives	π

I8 ~ Integer data (no decimal point allowed) is to be inserted in the space (field) of width 8 columns. Integers should be punched "right-adjusted," as far to the right in the field as possible, since blanks are interpreted as zeros. Examples follow:

-39	~	gives	-99,000
1024	~	gives	-99,000
-99	~	gives	-99,000

A6 ~ An arbitrary collection of characters (letters; numbers; punctuation) is to be inserted in this field of width 6. Blanks are a special unique character, remember, so 'BUS A ' and 'BUS A' are not the same. Examples follow:

BUS-1A
1.3+A5
GROUND

E10.3 ~ A decimal number is to be inserted in the field of width 10 columns. Use of scientific notation, with a power of 10 following the symbol "E", is added onto the previous rules for F-formats. Omitting the E and its following exponent is interpreted as a unity multiplier, so the E10.3 format then behaves just like F10.3. Right adjust the number if an E is punched, since just as with the I-format, any trailing blanks are interpreted as zeroes. Examples follow:

1.609E3	~	gives	1609
1.609E3	~	gives	1.609 * 10 ³
3.1415926	~	gives	π
-5.1	~	gives	-5.1
-5.2E-4	~	gives	-.00052
5.2E+4	~	gives	52000

There also is the option of free-format data specification, for half or more of the different EMTP data structures. The idea is simple. Rather than positioning data fields in fixed column locations, there is an ordering from left to right, with a separator character (usually a comma) used to delineate the field boundaries. If more than one data card is needed for the string of data items, a continuation character (usually a dollar sign) is used rather than a separator character, which means that another data card is to be read before extracting the next data item.

To illustrate, consider the special request word "POWER FREQUENCY" which provides for redefinition of the steady-state frequency (see Section 1.0c). Using free-format, this reads:

```
POWER FREQUENCY, 50
```

Rather than punching 50.0 in columns 33-40, then, ", 50" has been appended to the key word. The comma is a separator character, dividing the key word from the parameter; the space after it is optional, since blank characters are ignored in this mode. Note also that no decimal point has been punched, for integers and floating point variables are interchangeable when using free-format. For a realistic, full-scale application of free-format usage, see the data cards punched by the transformer impedance matrix program of Section 7.1 .

In case the user wants to redefine the free-format characters CSEPAR (for field separation) and CHCONT (for continuation), see Section 1.0g6 . This is not recommended, however.

More serious is the question of which EMTP data structures can be handled by the EMTP free-format. There is no simple rule. Read Section 1.0g6 for further perspective. In any case, be skeptical, and always test the capability before relying on it for the coding of any substantial volume of data.

For numeric data fields, blanks are ignored, no matter where they appear. For example, ", 10 3," is the same as ",103," .

For floating-point numbers, either "D" or "E" can be used to indicate a power of ten. Thus "1.E+9" and "1.D+9" are identical. Also, the plus sign preceding an exponent can be dropped, so that "1.E9" is equally valid.

Errors with the use of EMTP free-format capability can be confusing sometimes, due to the fact that execution will not always be stopped immediately. A KILL = 166 error flag can be set within module "FREFLD" , and there should be a line or two of immediate printout announcing the fact. But there is no easy way to immediately transfer control to the EMTP error overlays. It may take some time before an IF (KILL .GT. 0) error check will be encountered, at which point the formal EMTP error stop ("You lose, fella") will result.

Users should also be warned about possible precision problems with the use of EMTP free-format, as documented in Ref. 8, Vol. X, 3 July 1980, page MSDO-10. At issue is the accuracy of the library function handling of FORTRAN exponentiation ("**" operation). A standard procedure for avoiding the issue is to rely on the system-dependent READ (KK, *) operation. If full precision of the result is a concern of the reader, he should check with Program Maintenance about module "FREFLD" for his computer system. He might also look at the installation-dependent instructions (Section 0.5 onward).

Daniel's warning about possible need for extra commas at end of card
 =====

When Daniel (Prof. Daniel Van Dommelen of K.U.L. in Belgium, Chairman of the European EMTP Users Group) worked with us in Portland during August of 1982, he reminded me of some additional information about EMTP free-format usage, as mentioned on page 2 of a letter from him dated 26 May 1982. Although I have not independently checked this information, I pass it along as reliable rumor. If not true for current (the "M34." version now being documented during March of 1983) versions, it certainly must have been true for the "M28.+" and/or "M31." IBM versions with which he had been working at that time. The following were Daniel's points, as I summarized them during August of 1982:

- Restriction 1 : The branch type code ITYPE and four node names BUS1, BUS2, BUS3, and BUS4, must be contained in columns one through 26. Note that this is the normal fixed-format location. Why the EMTP needs this is no longer clear to me. I suspect that if the last name and its separator comma ("BUS4,") must be to the left of column 27, then the numeric data to follow must also be to the right of column 26. This agrees with the example of Vladimir's "TRELEG" output in the bottom half of page 100e.
- Restriction 2 : For the uncoupled, series R-L-C branch, at least nine data fields are required. Since only three floating-point fields are actually used, this suggests that six extra commas after the third of these might be a good idea.
- Restriction 3 : For coupled R-L elements, at least six data fields are required. Since the first phase only shows the use of two numbers, and extra four would seem to always provide safety. But what about Pi-circuits? Although I wrote nothing, I suspect that the rule of Restriction 2 might well apply to these as well. The "nine" data fields would correspond to three triplets of R-L-C parameters, which is the longest Pi-circuit data card ---- and probably the source of the trouble.

1. STRUCTURE OF EMTF INPUT DATA

Any number of cases can be run with one job submittal. Simply stack the data decks for the different cases:

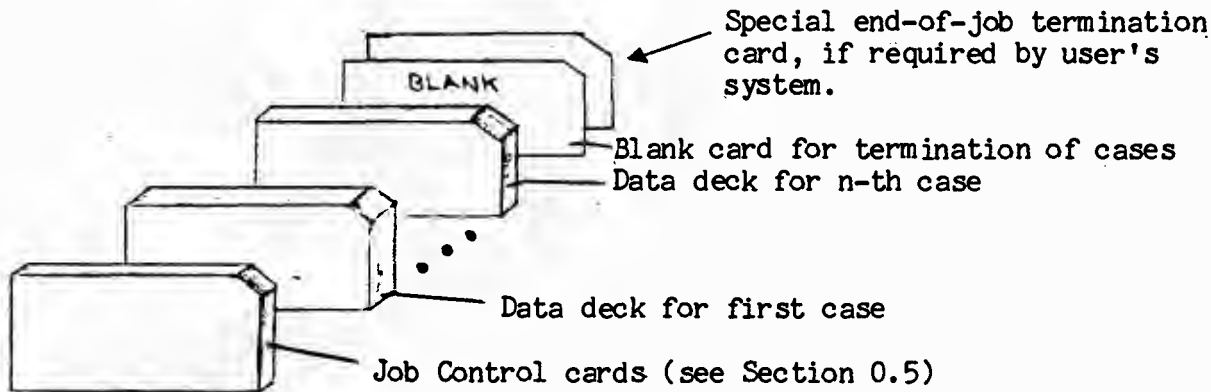

- a) DATA DECK : Each EMTF problem is described by a data deck (or data case) that is composed of the following parts, in order:
- 1) Cards to begin a new data case. Included are a "BEGIN NEW DATA CASE" card, special request cards of various types (if any), and finally the EMTF miscellaneous data cards.
 - 2) Specially-requested extensions to miscellaneous data cards.
 - 3) Cards that define any TACS (control system; digitally-simulated analog computer) modeling.
 - 4) Cards for linear and nonlinear branches, transformers, and transmission lines (or cables), terminated by a blank card.
 - 5) Cards for electric-network switches, diodes, and thyristers (ac/dc converter valves), terminated by a blank card.
 - 6) Source cards for electrical network (voltage sources, current sources, dynamic synchronous machines). These are terminated by a blank card.
 - 6a) Load flow cards for "FIX SOURCE" usage.
 - 7) Cards for over-riding the internally-calculated initial conditions (which come from the phasor steady-state network solution).
 - 8) Output variable specification cards. These are terminated by a blank card if the specification is selective. But if all node voltages are requested by means of a "1"-punch in column number 2, then there is to be no blank terminating card.

- 9) Cards for specifying Type 1-10 EMTF source functions point by point. There is one card for each time-step, terminated by a "9999" card.
- 10) Batch-mode plotting cards (either for CalComp plotting or line printer plotting), terminated by a blank card.

This data structure is for a single deterministic transient simulation, which is the most common case (see next paragraph for exceptions). Often data classes 2) , 3) , 7) , and/or 9) are not required, and can simply be omitted. If data class 5), 6) , or 10) might possibly not be needed due to the nature of the problem under consideration, then only the terminating blank card alone is required, and must never be forgotten.

There are valid EMTF data cases that do not have the above structure. The first class of such exceptions involves usage of the EMTF supporting routines. Examples are "LINE CONSTANTS" (used to calculate the constants of overhead transmission lines) and "REPLOT" (used for the batch-mode plotting of a previously-solved data case). The second class of such exceptions involves the usage of multiple-simulation features such as for statistical overvoltage studies (the "STATISTICS" request of switch cards). Details of such exceptions are covered in the body of this manual.

As seen from the preceding explanation of data-deck structure, the blank card is extensively used as a terminator card, for various classes of data. Sometimes a user is confused as to the purpose of one or more blank cards, and would like to add some explanation of the meaning. This is easy; just use "BLANK " for the first six characters, and the remainder of the card is available for comment. For example, "BLANK CARD ENDING BRANCH CARDS" . The EMTF recognizes all such cards, and blanks them out internally, before processing them (but after listing on the printer; they appear as as they were keyed by the user).

Just as with FORTRAN programming, "comment cards" of English-language (or French-language, etc.) text can be added to the data deck at any point. The punching of "C " in columns 1-2 is all that it takes for the EMTF to ignore a data card completely. Do not forget the blank in column two, however. Such comment cards will appear as part of the input data listing, but otherwise will be disregarded by the EMTF.

Also, whole blocks of data can be so ignored by the EMTF if recourse is made to \$DISABLE and \$ENABLE cards. Refer to Section 1.-D , as well as to the installation-dependent information for your computer system in Section 0.5a onward.

b) DESCRIPTION OF THE ELECTRIC NETWORK

Each non-ground node of the electric network is given a 6-character alphanumeric name. Only identical sequences of 6 characters will be recognized as one and the same node. Therefore, "VOLTS " will be a different node than " VOLTS". Six blanks (an all-blank name) is reserved for ground (common reference or local ground). Special names that the user should avoid are ".....", "TYP-16", "HEIGHT", "MARGIN", "SMOOTH", "TARGET", and "BRANCH".

Branches are identified by their data and the names of the nodes to which they are connected, or a 6-character element name (Sect. 1.-E).

Switches are identified in same way as branches.

Voltage and current sources are identified by node names and are assumed to be between the node and the local ground. If no ground resistance is involved, then "ground" is the common neutral. Otherwise "ground" means local ground.

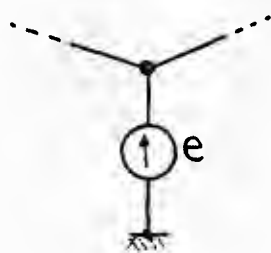
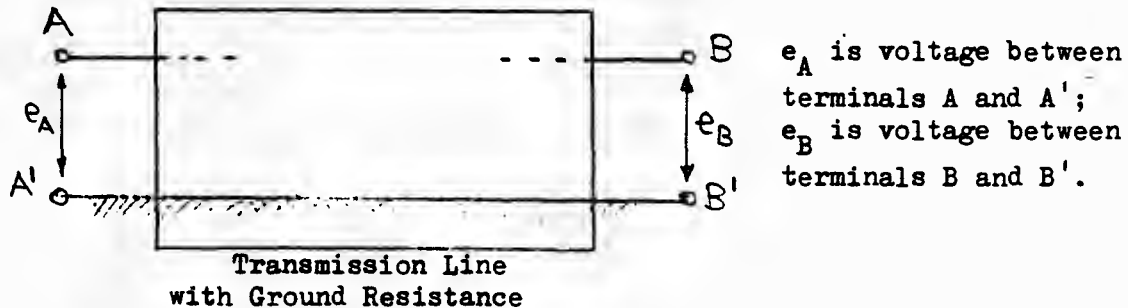

Voltage Source

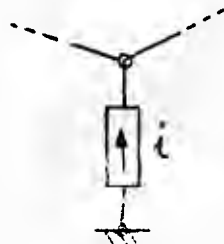

Current Source

Node voltage is the voltage from node to local ground.

Branch voltage is the voltage difference across a branch.

Output voltages of the EMTP consist of an arbitrary selection by the user of these two types of voltages. If one wants a voltage difference where no branch exists (or where such output is otherwise not permitted), the user need only add a very high resistance branch between the nodes in question, and request thereupon the branch-voltage output. Acceptable values for this purpose are 1.E18 for Univac and Honeywell/GE, 1.E35 for IBM, and 1.E100 for CDC.

Current source between 2 nodes: A current source from node A to node B can be represented by two current sources, one out of node A and one into node B.

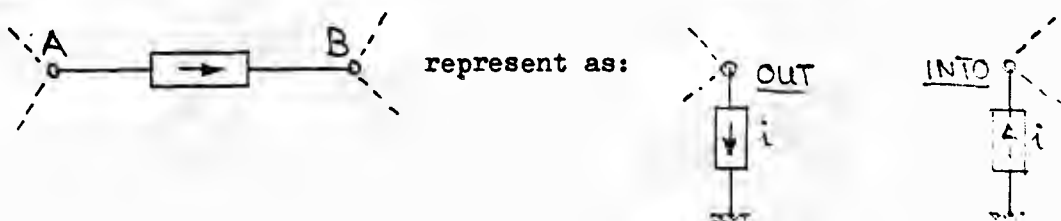

This representation does not change any impedances between nodes A and B.

Voltage source between 2 nodes: If the voltage source between 2 nodes has an internal resistance, then make an equivalent current source out of it and treat it as such (see Point 9), Section 1.6). For example,

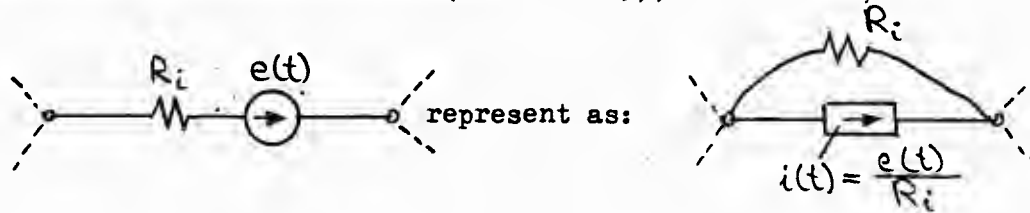

If $R_i = 0$, then the voltage source between 2 nodes cannot be handled by this program.

Voltage sources in series: If more than one voltage source is specified at the same node, the voltages will be taken in series from ground to that node. This permits the representation of a complicated wave form as a sum of different functions.

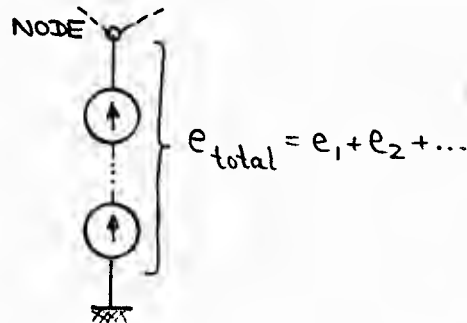

Current sources in parallel: If more than one current source is specified at the same node, the currents will be taken in parallel from ground to node.

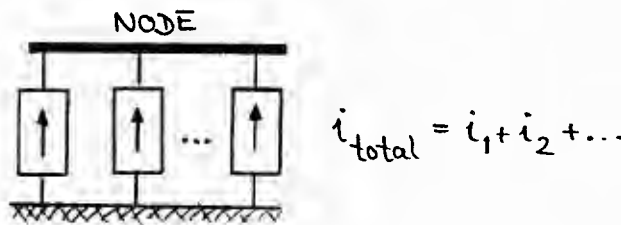

Simultaneous voltage and current source on same node: If voltage and current sources are specified at the same node, the voltage sources override and the current sources are ignored. Both forms cannot exist simultaneously.

Connectivity Requirement: With all nonlinear and time-varying branches deleted, the resulting equivalent resistive netw which is solved at each time step must be connected. See details in Section 1.3-D.

C) DESCRIPTION OF CONTROL SYSTEMS

The preceding summary has considered only the description of the electric network (resistors, capacitors, voltage sources, etc.). The modeling of control system dynamics is separate and distinct, as provided by the TACS code of Section 8.

Control system blocks can take various forms: Laplace transfer functions, summing junctions, nonlinear algebraic operations (multiply, divide, square root, etc.), logical operations, etc. The output of each control system block is given a distinct 6-character alphanumeric name, so as to identify the signal in question. Such blocks can be defined and interconnected arbitrarily by the user, forming a control system circuit. One such sample illustrative diagram is shown below:

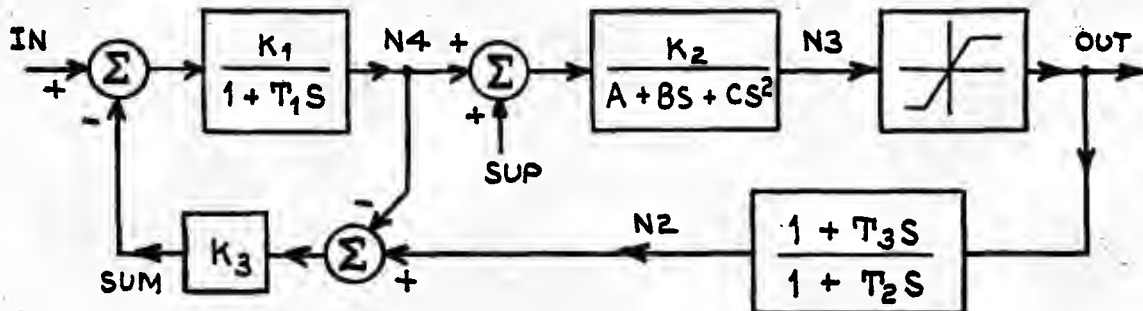

It might be mentioned that any given 6-character alphanumeric name can be used once in TACS and also once in the electric network; there is no confusion by the EMTP, since the TACS solution is completely separate from the electric network solution. Such double usage is in fact recommended in the case of interface quantities, to remind the user of the connection.

Note the one-way flow of signals (unlike for the electric network, control system components have an orientation, and are not bilateral). Signal sources which serve as input to such control circuitry can be either self-contained (e.g., a sinusoidal oscillator, or a step function), or can be controlled by the electric network (e.g., any node voltage or any switch current can be used as a TACS source). Likewise, any TACS variable can be passed back to the electric network for control purposes (e.g., the status of an electric network switch can be controlled by TACS, as can a voltage source, or the field voltage of a dynamic synchronous machine. Variables of this type which are passed back and forth between the electric network and TACS are referred to as interface quantities.

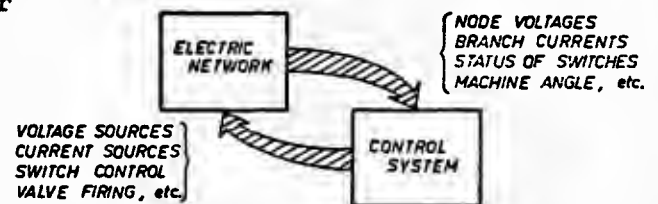

Fig. 7. Dynamic interaction between electric network and control system.

D) \$-CARDS for Special File Operations

The dollar sign "\$" is conventionally used as the continuation character CHCONT for free-format specification (see Section 1.0g6). But when placed in column number one, and when followed by the appropriate key word, it represents a request for a higher-level file operation.

The exact form of \$-cards, as well as the list of available key words and their meanings, will vary somewhat from one computer system or installation to another. If no instructions are to be found in Section 0.5a onward for the computer system of interest, check with the on-site Program Maintenance. Should they in turn deny all knowledge, procure a listing of the FORTRAN code of module CIMAGE (see near the beginning of Section 0.5 for the location), and study it. If \$-cards are allowed, there should be very conspicuous comment cards and DATA statements which define the acceptable key words. For the original VAX implementation, see Ref. 8, Vol. X, 20 January 1980, pages ANFC-1 through 7.

One trivial \$-card function whose form is invariant on all systems (and which can clearly be implemented on any system) is the \$DISABLE/ENABLE feature. A \$DISABLE card tells the EMTP to treat all following data cards as if they were comment cards, until the subsequent appearance of a \$ENABLE card. This is a very handy feature for big blocks of comments, or for the temporary removing of components from a data case without actually throwing the records away (one might want to later restore them).

Another universal \$-card is the \$LISTOFF/LISTON feature. A \$LISTOFF card tells the EMTP not to print and interpret data cards which follow. This continues until a \$LISTON card is encountered. The object is to minimize the size of the output file by omitting the listing and interpretation of blocks of data which have been tested and used before. This is particularly advantageous for users of slow (e.g., 300 baud) typewriter terminals, to speed the printout.

A third universal \$-card is the \$DIAGNOSTIC,M card, where "M" is an integer (diagnostic printout control variable IPRSUP; see Section 1.0h, integer miscellaneous data card). Within the overlay currently being executed, this allows redefinition of the dumping level. When the current overlay is left, however, the \$-card definition is lost. Free-format is used for the ",M" part, so imbedded blanks are permitted here. Printout can be turned off later in the overlay using \$DIAGNOSTIC,0 (remember that level zero implies none). Use of this \$-card does not replace the "DIAGNOSTIC" special-request card of Section 1.0g7 (for diagnostic control overlay by overlay). In fact, this is why the \$-card definition is local to the overlay: because IPRSOV is used to reset IPRSUP every time a new overlay is begun.

A fourth universal \$-card is \$STOP, to terminate execution immediately (within input module "CIMAGE", as the card is read).

A fifth universal \$-card is the \$WIDTH,M card, which allows the user to switch between 80 and 132-column EMTP output widths for different parts of the program output (M=80 or M=132 here). This will revise any earlier "OUTPUT WIDTH 80" or "OUTPUT WIDTH 132" card.

Finally, the universal \$VINTAGE,M card allows the user to choose between old and new data formats on a component by component basis. Here integer constant "M" characterizes the age of the data (only 0 and 1 have meaning as of the inauguration in June of 1980, for "M28." versions). Data options will be described later in the manual, along with the components which allow such choice.

By far the most important \$-card is \$INCLUDE, which was named after a comparable FORTRAN feature (in the Univac and VAX dialects, anyway). Also on this data card will be the specification of a file, which will vary from system to system. When \$INCLUDE is encountered, the EMTTP switches to the named file for all input. This continues until an end-of-file is encountered, at which time reading from the original input file (connected to unit LUNIT5) is resumed.

The user of any non-universal \$-card feature must remember that his data case is installation-dependent. He must not try to solve such a data case on a different computer system than it was set up for, without consideration of needed changes to one or more \$-cards.

E) 6-Character Element Names for Branch and Switch Identification

In the beginning, when cases were small and methods were less mechanized, the use of the pair of terminal node names was adequate for element identification. But since this is often not unique (parallel branches are allowed, and switches may parallel branches), there can be confusion and/or error from this, so branches have also been given 6-character names just as nodes are. In the years ahead, it is expected that branch and switch names will receive increased usage. So, although today the feature is not common, program users should at least be aware of the concept, and how it can be employed.

The first point is that each and every branch and switch is given a default name, before any data input begins. If DIAGNOSTIC printout is turned on, or if EMTSPY is used for interactive observation (with BRANCH or SWITCH commands), these names will be seen:

LIN001, LIN002, etc. for rows of the linear branch table;
 NLN001, NLN002, etc. for rows of the nonlinear element table;
 SWT001, SWT002, etc. for rows of the switch table.

Hence, even if the user does not supply names of his own (as explained below), he can use these default names, which really correspond to referring to elements by number in the associated table.

For both linear and nonlinear branches, it is simple to supply a name provided the element of interest is not a copy of some preceding element. In this case, the BUS3 and BUS4 name fields (columns 15 through 26) would otherwise be left blank. To provide a name, use:
 BUS3 = "NAME:" ---- A request word for the naming operation
 BUS4 = "?????" ---- Whatever branch name the user desires.
 This is not possible for switches, however, since no such name fields exist (unfortunately).

To copy a previously-named branch using the 6-character branch name of that original branch (rather than the pair of terminal node names), one again uses the two 6-character name fields of cols. 15-26:

BUS3 = "COPY " ---- A request word for the copying operation
 BUS4 = "???????" ---- Name of the branch being copied.

To name a branch which is a copy of some preceding branch (so that columns 15-26 are already being used), precede the branch to be named by a special, extra card which performs this function. The just-listed BUS3 and BUS4 appear in columns 15-26 of this extra card; in columns 3-14, add the special-request text:

BRANCH NAME: ---- if following branch to be named is linear

NONLIN NAME: ---- if following branch to be named is nonlinear

This will be extended to switches (using "SWITCH NAME:") for program versions dated 1 April 1983 ("M34.+") or later. Note that for switches, it is the one and only way of providing a name. But for versions of "M34." or earlier vintage, no such capability exists.

1.0 CARDS TO BEGIN A NEW DATA CASE (INCLUDING MISC. DATA CARDS)

Each new data case which is to be solved must be begun with one or more of the data types described in the following subsections. Structurally, there are an indeterminate number (possibly zero) of special-request inputs which come first, in any order. The miscellaneous data cards of Section 1.0h only come after the last of any such special-request inputs for the data case.

It should be mentioned that free format is particularly useful for special-request inputs, for the user who is assembling data via a conventional computer terminal (on which column position is not intuitively obvious). Take the "FREQUENCY SCAN" output of Section 1.0g3 as an example. Using free format, a valid sample card image is as follows: "FREQUENCY SCAN, 10., 5.0, 100., 0" . Even further abbreviation is possible for the really-lazy data assembler; rather than using the full request word, an acronym made up of the first letter of each sub-word can be used. In this case, "FREQUENCY SCAN" can be abbreviated to "FS" , if desired.

In the order that they are explained in subsequent sections, the following key words are recognized at this point of EMTP data input:

BEGIN NEW DATA CASE	case-separation cards
PRINTER LINES PER INCH	redefine no. of lines/inch on printer output
PLOTTER PAPER HEIGHT	redefine height of paper on a Calcomp plot
LIMIT ON PLOT OSCILLATIONS	redefine no. of osc. allowed before averaging
REDEFINE TOLERANCE EPSILN	redefine EPSILN for cases w/o misc. data cards
HIGH RESISTANCE	redefine R of internally added resistor
POWER FREQUENCY	synchronous power system frequency
REPLOT	batch-mode plot of case solved before
FILE REQUEST	access to module "MIDOV1" during input
USER IDENTIFICATION	user i.d. info. for batch-mode plot file
ABORT DATA CASE	skip the current data case
KILL CODES	print context of the kill codes
AVERAGE OUTPUT	average the values of EMTP output variables
ABSOLUTE TACS DIMENSIONS	allocation of storage for 8 TACS tables
RELATIVE TACS DIMENSIONS	relative sizing of the 8 TACS tables
TABULATE ENERGIZATION RESULTS	combine different runs of a statistics case
STATISTICS OUTPUT SALVAGE	save results of a statistics run

OMIT BASE CASE	skip base base solution in a statistics case
MISCELLANEOUS DATA CARDS	read miscellaneous data cards
CHANGE PRINTOUT FREQUENCY	change frequency of solution printout
BEGIN PEAK VALUE SEARCH	time at which extrema computation is to begin
TIME OF DICE ROLL	the time before which no random closing occurs
PEAK VOLTAGE MONITOR	request for peak node voltage
ABSOLUTE U.M. DIMENSIONS	allocation of storage for the 4 U.M. tables
RELATIVE U.M. DIMENSIONS	relative sizing of the 4 U.M. tables
START AGAIN	restart a halted simulation
TIME STEP LOOP	transfer of control to time-step loop
POSTPROCESS PLOT FILE	postprocess plot file using TACS
USER SUPPLIED SWITCH TIMES	user supplied random switching times
FIX SOURCE	EMTP load flow
MODE VOLTAGE OUTPUT	modal voltage output for distributed lines
JMARTI SETUP	freq.-dep. rep. of lines using "JMARTI SETUP"
XFORMER	derive impedance matrix for transformers
SATURATION	access B-H curves, hysteresis, ZnO data
WEIGHTING	freq.-dep. rep. of lines using "WEIGHTING"
LINE CONSTANTS	calculate overhead line constants
SEMLYEN SETUP	freq.-dep. rep. of lines using "SEMLYEN SETUP"
CABLE CONSTANTS	calculate cable system constants
ANALYTIC SOURCES USAGE	user supplied sources
TACS EMTP SOURCES	TACS-defined, user supplied, sources
FREQUENCY SCAN	multiple-freq. steady state solutions
RENUMBER BYPASS	bypass transient node renumbering
FREE FORMAT	redefine free format delimiters
DIAGNOSTIC	selective diagnostic printout
ALTERNATE DIAGNOSTIC PRINTOUT	selective printout in time-step loop
CUSTOM PLOT FILE	change precision of the plot file
OUTPUT WIDTH 80	request for 80-column output
OUTPUT WIDTH 132	request for 132-column output
MODIFY SWITCH LOGIC	alternative switch logic
FAULT DATA USAGE	request for generator equivalent
TACS WARN LIMIT	redefine limit on no. of TACS warnings
STEP ZERO COUPLE	subnetwork ident. with all switches closed
CONVERT ZNO	convert old data of $Z_n \cup$ to new formats
ZINC OXIDE	redefine controls of Newton iteration for ZnO

1.0a Optional Case-Separation cards

While not mandatory, it is good practice for the EMTF user to make the very first card of each data case a special case-separation marker:



See the sample data listing of Section 2.3 for an example of this usage.

For runs which terminate normally, or single-data-case runs, this card just described serves no operational purpose; it does of course appear on the 80-column input data listing, with appropriate interpretation on the left, but that's all.

On the other hand, should the EMTF decide to prematurely terminate execution of a particular data-case solution (with an EMTF error message), then a case-separation marker does come in handy. The EMTF automatically steps over remaining input cards, discarding them one at a time until it finds such a "BEGIN NEW DATA CASE" record. At this point, a new data case is known to begin, so the EMTF can correctly recover to solve the just-found following case. This is referred to as EMTF error-recovery capability, during multiple-data-case runs.

Yet suppose that it was during the solution of the final data case of the run that a fatal EMTF error termination occurs. In this case there would be no following data case, so further solutions would not be possible. To distinguish this situation, the final data case should always be followed by a "BEGIN NEW DATA CASE" card and a blank card --- which then will terminate execution. The blank card in this situation is read as the start of a new data case, and the lack of any punching on it is recognized by the EMTF as the end of all data cases.

It should be emphasized that "BEGIN NEW DATA CASE" cards must be properly positioned in the data deck; they do not in any way alter the need for blank termination cards (the function of which is explained elsewhere in this manual). The identity and function of these special cards is recognized by the EMTF in only two places.

1. Following an EMTF fatal error, such cards are watched out for, as other records of the input data are discarded.
2. Following normal completion of the solution for any particular data case, the very first non-comment record of the following data case will be checked for "BEGIN NEW DATA CASE".

Any other placement of these key cards will generally lead to program bomboff, since the alphanumeric text will be either read or decoded numerically, which is impossible, and will lead to a system error.

1.0b Blank Card for the Termination of EMTF Execution

The normal termination procedure for the EMTF is to have the first card of the following (non-existent) data case completely blank; by agreement, this means that there remain no more data cases to be solved, and EMTF execution is terminated.

In order to protect against bomboff by the operating system in the event that data should run out on the input file of the EMTF, the just-mentioned final blank card should always be preceded by a "BEGIN NEW DATA CASE" card. This is as per Section 1.0a.

1.0c Special Request Cards to Redefine Built-In Program Parameters

There currently are three plotting parameters which are given default or nominal values by the EMTF, but which can be redefined at the start of any new data case, if this is desired by the user. These are as follows:

Variable "LNPIN" :

1	2	3	4	5	6	7	8	9	10	11	12	13	14	15	16	17	18	19	20	21	22	23	24	25	26	27	28	29	30	31	32	33	34	35	36	37	38	39	40
PRINTER LINES PER INCH																						LNPIN																	
5A4																						18																	

Used only in conjunction with the line-printer plotting of graphs, variable "LNPIN" gives the number of lines per inch to which the line printer has been set. Since both 6 and 8 lines/inch are common in the USA, the user should check with Program Maintenance as to which default value his particular program translation has been set for. In any case, redefinition is by means of the above-listed special request card which carries the text "PRINTER LINES PER INCH" in columns 1-22, and the new desired value for "LNPIN" punched in columns 33-40 as 18 information.

Variable "SZPLT" :

1	2	3	4	5	6	7	8	9	10	11	12	13	14	15	16	17	18	19	20	21	22	23	24	25	26	27	28	29	30	31	32	33	34	35	36	37	38	39	40
PLOTTER PAPER HEIGHT																						SZPLT																	
5A4																						E8.0																	

Variable "SZPLT" is the height of the graph paper upon which Calcamp plots are to be drawn. Protection against pen movements which would go off the top of the paper (higher than "SZPLT" inches, relative to the location where the pen is initialized at the bottom of the paper) is provided by this variable. The nominal value presently used for "SZPLT" is 10.0 inches, though this may vary from translation to translation; the user should consult with Program Maintenance to find out what built-in value exists for his program. In any case, redefinition is by means of the above-listed special request card which carries the text "PLOTTER PAPER HEIGHT"

42-1

in columns 1-20, and the new desired value for "SZPLT" punched in columns 33-40 as E8.0 information.

Variable "NSMTH" :

1	2	3	4	5	6	7	8	9	10	11	12	13	14	15	16	17	18	19	20	21	22	23	24	25	26	27	28	29	30	31	32	33	34	35	36	37	38	39	40
LIMIT ON PLOT OSCILLATIONS																																NSMTH							
																																18							

Variable "NSMTH" is a limit on the number of successive ups and downs which a curve being plotted is to be allowed, before the averaging of successive ordinates for all later time is to be instituted. A default value of 50 is normally used (assigned in installation-dependent module "SYSDEP" ; see Section 0.5 for location). In any case, redefinition of this variable is possible by means of the special request card reading "LIMIT ON PLOT OSCILLATIONS" ; the new oscillation limit is to be punched in cols. 33-40.

Currently there also are three non-plotting parameters which can be redefined by the user, if need be, as follows:

Variable "EPSILN" :

1	2	3	4	5	6	7	8	9	10	11	12	13	14	15	16	17	18	19	20	21	22	23	24	25	26	27	28	29	30	31	32	33	34	35	36	37	38	39	40
REDEFINE TOLERANCE EPSILN																																E8.0							
																																EPSILN							

The familiar floating-point miscellaneous data parameter "EPSILN" (see Section 1.0h) is used far more than for the stated reason of checking matrix singularity. Often the EMTF wants to know whether a floating-point result is getting small, and "EPSILN" (possibly scaled by a power of ten) is usually used as the standard of comparison. This may occur in the solution of EMTF data cases which have no miscellaneous data cards, however, so that the user would otherwise have no control over this important parameter. A "LINE CONSTANTS" or "CABLE CONSTANTS" data case is such an example. By means of the "REDEFINE TOLERANCE EPSILN" request card shown above, the user can redefine this value at will. The default value is set in installation-dependent module "SYSDEP" (see Section 0.5), and typically has a value of 1.E-8 for REAL*8 translations, and 1.E-5 for 36-bit translations.

Variable "KPARTB" :

1	2	3	4	5	6	7	8	9	10	11	12	13	14	15	16	17	18	19	20	21	22	23	24	25	26	27	28	29	30	31	32	33	34	35	36	37	38	39	40
HIGH RESISTANCE																																18							
																																KPARTB							

Type-99 pseudo-nonlinear elements (see Section 1.28) have large resistance internally added, always. The value of resistance in both of these cases is normally based on the near-zero round-off tolerance "FLZERO" which is defined within installation-dependent module "SYSDEP (see Section 0.5). For example, most REAL*8 translations (IBM, VAX, PRIME, SEL, etc.) will have FLZERO = 1.E-12 . The EMTP uses resistance value RINF = .01/FLZERO ohms, or 1.E+10 for REAL*8 machines. Generally no problem in this case. But for lower-precision translations like the 36-bit Honeywell and Univac ones, the resulting RINF value will drop, and may be bothersome. By means of the "HIGH RESISTANCE" request card shown above, the default value of RINF can be replaced by 10**KPARTB . The user thus has control within a power of ten.

Variable "STATFR" :

POWER FREQUENCY	STATFR
4A4	E8.0

Variable "STATFR" is the synchronous power system frequency, in Hertz. This will normally be 50 Hz or 60 Hz, depending on the translation being used (the definition is made within installation-dependent module "SYSDEP" of overlay number 1). Yet special cases can be of interest (e.g., the 400Hz usage of the aircraft industry, or the usage of both 50 Hz and 60 Hz within Japan). In any case, if the user wants to change variable "STATFR", he need only punch a card according to the above format; the text "POWER FREQUENCY" is to be punched in columns 1-15, and the desired new power frequency goes in columns 33-40 as E8.0 information.

If the user chooses to alter two or more such parameters, the order of requests is immaterial. If the data case in question is a "REPLOTT" case, the above-described parameter redefinition cards (if any) must precede the "REPLOTT" card (see Section 1.0d), since immediately thereafter program control will be transferred to plotting.

1.0e Calling of Installation-Dependent Module "MIDOV1"

The principal installation-dependent module that is called at the start of execution of each data case is "SYSDEP". But there is yet another such module in overlay 1 which is used for initialization (see Section 0.5): "MIDOV1". For some computer systems, for certain special types of data cases, it may be necessary or desirable to have "MIDOV1" called at a certain point during the data input. This is possible, by means of the special request card "FILE REQUEST" (see format at the right). But a warning should be issued: do not use this without the knowledge and approval of Program Maintenance.

1	2	3	4	5	6	7	8	9	10	11	12	13	14	15	16	17	18
FILE REQUEST																	

1.0e1 Redefinition of 6-character Text "USERID"

In conjunction with the batch-mode plotted output (CalComp) of Section 1.10, there is the problem of identifying which plot belongs to which user. Of course, individual installations may have special exotic ways, in which case there is no problem. But if this is a problem, the EMTp comes to the rescue with six characters of user-name type identification "USERID". For sophisticated implementations, the assignment of an identifying name will automatically be performed within installation-dependent module "SYSDEP" (see Section 0.5), so the user need not be concerned by it. During and before 1978, this was done at BPA for the CDC installation. But for some systems it may be difficult to obtain such user identification at the FORTRAN level, or the user may want to over-ride it in any case. Such a redefinition of the six-character contents of "USERID" is possible, using the following special-request card:

1	2	3	4	5	6	7	8	9	10	11	12	13	14	15	16	17	18	19	20
USER IDENTIFICATION																A6			
																		USERID	

1.0e2 Card to Disable an Entire EMTp Data Case

Suppose a user has an EMTp data case which he wants to keep, but which he also knows is defective for one reason or another. To prevent the running of such a data case (and subsequent bomboff of the entire job of several data cases, for example), a user can resort to the key-word card shown immediately below. Once this is encountered, the EMTp will skip input records until the next "BEGIN NEW DATA CASE", at which point execution begins anew.

1	2	3	4	5	6	7	8	9	10	11	12	13	14	15	16	17	18	19	20
ABORT DATA CASE																			

1.0e3 Request for the Printing of EMTp KILL Codes (Error Messages)

It is sometimes handy to be able to generate the text of any particular fatal EMTp error message (KILL code) without actually having to set up a data case which will so bomb off the machine during execution. This is possible for most systems, using the request:

1	2	3	4	5	6	7	8	9	10	11	12	13	14	15	16	17	18	19	20	21	22	23	24	25	26	27	28	29	30	31	32	33	34	35	36	37	38	39	40	41	42	43	44	45	46	47	48
KILL CODES																															I8						I8										
																															KILL1						KILL2										

The key-word "KILL CODES" begins in column 1, and KILL1 and KILL2 are the beginning and ending KILL numbers of the consecutive KILL codes which are to be printed. Of necessity, KILL2 must not be less than KILL1.

A few words about the functioning of this feature are in order. As of April of 1980, EMTP error messages are confined to five overlays: 51, 52, 53, 54, and 55. The first four of these have 50 error messages each, and the last is well short of this limit (when we reach 50, a new overlay is created). As we loop over KILL codes, control always begins in overlay 51; then, a transfer is made to the overlay that has the error message in question (e.g., overlay 52 for KILL between 51 and 100); then a transfer is made to overlay 55, to the end of the loop; finally, if this is not the last error message, control passes back to overlay 51 where it began, and the cycle repeats. Of these three overlay transfers, not that one can be omitted (only two are actually required) if the error message is located in overlay 51 or overlay 55. Now, for computers with overlaying (non-virtual), all of this rolling of code in and out can be time consuming. In the Vol. VIII EMTP memo of Ref. 8, page AOVA-3 presents some CDC-6500 times as part of my bigger argument for virtual architecture. The figure presented is about 25 seconds of I/O time for each error message, worth perhaps 83 cents. On such a computer, then, do not expect to dump 100 or 150 error messages rapidly and economically.

Another caution is in order. Systems which do not allow the printing of garbage may have trouble with this feature. VAX is one such system, and the printing of a range of KILL codes will typically end prematurely with an I/O complaint by the operating system. We never had that problem with CDC. If this becomes a problem, perhaps later we shall carefully initialize all variables of /BLANK/ before the printing begins; but as of April, 1980, there is no such initialization, so a lot of garbage is printed.

1.0e4 Request to Average EMTP Output

By means of the special-request text "AVERAGE OUTPUT" beginning in column one, the user signals his intention that successive values of EMTP output variables be averaged before printing and plotting. The mathematics of EMTP solution are not affected; this is just a massaging of the answers at the time answers are printed and written to the LUNIT4 plot file. By averaging is meant the arithmetic mean of the current and the preceding variable value, $(V_{new} + V_{old})/2$.

1	2	3	4	5	6	7	8	9	10	11	12	13	14	15	16	17	18	19
AVERAGE OUTPUT																		

For studies where EMTP output variables are smooth functions of time, the "AVERAGE OUTPUT" request would have negligible effect, and should not be used (it just adds a small error to the answer). But there are problem cases like that of the hanging inductor (see the two pages of discussion in Section 1.40 about "REMARKS ON OPENING ACTION"). There are pathological cases where the trapezoidal rule gives answers that oscillate around the true value, so that this remedy is useful.

1.0e5 Request for Allocation of Total TACS Storage

TACS is the control system modeling feature of Section 8. Total working space for all TACS tables is assigned in List 19, along with the other 27 or so EMTF lists (see Section 0.6). But there still remains the question of how this total working space is to be divided among the 8 TACS tables. This allocation is performed at execution time, according to the description of the present section, thanks to the procedure of offset subscripting (see Ref. 8, Vol. VIII, 27 January 1979 page PROV-19 through 22).

The first way to allocate total TACS storage is with a request for absolute TACS table sizing, followed by two data cards giving those desired sizes:

ABSOLUTE TACS DIMENSIONS							
LT ₁	LT ₂	LT ₃	LT ₄	LT ₅	LT ₆	LT ₇	LT ₈

The format for the list sizes is (10I8), with the 8 TACS table sizes having the following meaning:

- LT1 : Maximum number of TACS dynamic function blocks, having Laplace transfer functions $H(s)$.
- LT2 : Maximum number of nonzero factors of the triangularized TACS network matrix. This limit applies to both the steady-state solution and the transient solution.
- LT3 : Maximum total number of input variables to TACS dynamic function and supplemental devices.
- LT4 : Maximum number of TACS sources. This includes built-in sources (e.g., "TIMEX" or "UNITY"), and variables passed from the electric network to be TACS driving functions.
- LT5 : Maximum number of supplemental variables and devices (type codes 99, 98, or 88 punched in columns 1-2).
- LT6 : Maximum total number of extra INTEGER pointers which are associated with supplemental variables and devices. There is no easy, exact formula, although sample figures can be given. Each parenthesis requires 3 cells, as does each arithmetic operation ("+", "*", "=").
- LT7 : Maximum total number of extra REAL cells which are associated with TACS variables. Each TACS variable requires one or more such cells. Again, a simple rule is impossible to state. Each first-order function block requires 10 cells, intermediate variables of supplemental-variable expression evaluation each requires one, the average device might require between 3 and 5, and the most complex device (the RMS sensor, Type 66) requires $1 / (f * DELTAT)$ where "f" is fundamental frequency.

This applies to translations having integers which are half as long as floating-point variables (INTEGER*4 vs. REAL*8 for IBM PRIME, VAX, SEL). Proportions are a little different for computers where floating-point variables are the same length as integers (CDC, Cray, Burroughs, FPS-164; also single-precision Univac and Honeywell).

In the absence of either such special request card for TACS dimensioning, the EMTP sets dimensions according to the following default absolute dimensions:

20 90 100 20 30.250 300 60

Depending upon the size of List 19, execution may or may not be possible (i.e., even with default dimensioning, there still might not be sufficient table space for execution).

1.0e6 Request for Combination and Tabulation of "STATISTICS"

Provided the user has previously executed a "STATISTICS" data case one or more times beforehand, and saved the essential internal tables (using "STATISTICS OUTPUT SALVAGE" request of Section 1.0e7), then it is possible to proceed with the statistical tabulation of overlay 29. This

begins with a special-request card reading:

1	2	3	4	5	6	7	8	9	10	11	12	13	14	15	16	17	18	19	20	21	22	23	24	25	26	27	28	29	30	31	32	33	34
TABULATE ENERGIZATION RESULTS																																	

--- followed by a statistics miscellaneous data card (see Sect. 1.1a). At this point, program control is transferred to overlay 29, where the 3-digit integers that uniquely identify all previous simulations (see parameter JFLSOS of Section 1.0e7) are specified:

I8	I8	I8	I8	I8	I8	I8	I8	I8	I8
JF ₁	JF ₂	JF ₃	JF ₄	JF ₅	JF ₆	JF ₇	JF ₈	JF ₉	JF ₁₀

Use as many cards as desired, skipping any of the 8-column data fields if this is convenient. Ordering of the integers is immaterial. Signal the end of such data by punching "9999" in a field to the right of the last real integer specification.

That is all that can be said for the data input. This constitutes the end of data for such a data case. After this universal data input in "SUBR29" is accomplished, installation-dependent module "STATRS" of overlay 29 is called, once for each partial simulation which is now to be tabulated. Module "STATRS" actually attaches (connects) the associated disk files, and reads the data into internal program storage.

the job bombed off for some reason, on the BPA CDC-6500 the EMTF would regain control from the operating system (provided the system itself had not crashed), and would save the relevant "STATISTICS" files by a call to installation-dependent module "STATSV" of overlay 55. But this is the exception rather than the rule. Systems as nice as this do not seem to be built any more (those were the good old days, when it came to salvaging "STATISTICS" simulations)!

1.0e8 Request for Omission of Base Case of "STATISTICS" Simulation

The conventional "STATISTICS" or "SYSTEMATIC" data case i involves a base case solution before any of the NENERG (integer miscellaneous data parameter; see Section 1.0h) energizations are begun. This is a preliminary shot right down the middle, with all of the variances set to zero. Well, the user can suppress this extra, preliminary simulation by a special request card reading:

1	2	3	4	5	6	7	8	9	10	11	12	13	14	15	16	17	18	19	20
OMIT BASE CASE																			

Resulting statistical tabulations are unaffected, since the base case solution was not part of the statistical processing anyway. So, if the user already knows what the base case solution looks like, he can save one shot, as well as some paper. A classic case is where one is solving one of several small pieces of a bigger problem, using "STATISTICS OUTPUT SALVAGE" as in Section 1.0e7. It would be wasteful and unnecessary to repeat the same base case solution for each piece of the problem that is solved.

1.0e9 Request to Read Miscellaneous Data Cards

The floating-point and integer miscellaneous data cards are described in Section 1.0h. For a conventional simulation, they come after all special requests of the type now being considered. For the normal simulation this is fine, and there is no problem.

But in special circumstances, the user may want to define one or more of the miscellaneous data parameters ahead of time. Perhaps I should not say "ahead of time," since in the extreme case where there is no simulation at all (e.g., when using "LINE CONSTANTS"), such data cards would otherwise never be read. Anyway, the user can have miscellaneous data cards of Section 1.0h read at this time provided he precedes the cards by the appropriate special-request word:

1	2	3	4	5	6	7	8	9	10	11	12	13	14	15	16	17	18	19	20	21	22	23	24	25	26	27	28	29	30	31	32	33	34	35	36	37	38	39	40	41	42	43	44	45	46	47	48	49	50	51	52	53	54
MISCELLANEOUS DATA CARDS																																																					
10E8.0 ~ floating point miscellaneous data card																																																					
10I8 ~ integer miscellaneous data card																																																					

The user is advised not to do this casually, however; there should be a real, known need, and local Program Maintenance should be aware of the usage.

1.0e10 Request to Change the Frequency of Time-Step Loop Printout

Printout in the time-step loop has frequency controlled by integer miscellaneous data parameter IOUT of Section 1.0h. But this frequency can be changed as simulation time progresses. Begin with the special-request card shown at the right, and follow this with the card of (KCHG, MULT) pairs of Section 1.1b:

1	2	3	4	5	6	7	8	9	10	11	12	13	14	15	16	17	18	19	20	21	22	23	24	25	26	27	28	29
CHANGE PRINTOUT FREQUENCY																												

1	2	3	4	5	6	7	8	9	10	11	12	13	14	15	16	17	18	19	20	21	22	23	24	25	26	27	28	29	30	31	32	33	34	35	36	37	38	39	40
1 st Change								2 nd Change								Etc.																							
KCHG								MULT																															
18								18																															

This card specifies at what time-step numbers the printout frequency is to be changed, and what values the frequency is to be changed to. Up to five pairs of step numbers and new printout frequencies are permitted, as per the following definitions:

- $KCHG_i$ ----- Time-step number at which the i -th variation in the printout frequency is to begin. Printout for this particular step number is always provided, as a beginning to the new frequency of output.
- $MULT_i$ ----- Modified value of "IOUT" (see second misc. data card), to begin at time-step number $KCHG_i$.

A change in the printout frequency was originally provided as per Section 1.1b, if integer miscellaneous data parameter IPUN was given a value of minus one. That still applies. But IPUN also has meaning when it is positive: the punching of terminal conditions. The user may want to do both of these operations in the same data case, which was impossible before (variable IPUN could not be both negative and positive at the same time). The special request card of the present section resolves this potential conflict. Users may prefer it even if there is no conflict.

1.0e11 Request for Delay in Extrema Calculation

The integer miscellaneous data parameter MAXOUT (see Section 1.0h) provides for the calculation and output of variable extrema. The same vector of extrema is used for "STATISTICS" and "SYSTEMATIC" output as well. Normally, extrema are wanted over the full time span of the simulation. But not always. There are cases where one wants to ignore a certain initial interval of the simulation, only considering transients after a certain minimum time. For example, in a "STATISTICS" simulation, it is possible that random closing shall follow the opening of breakers (clearing of a fault), but that the peak simulation voltage will be produced during the deterministic opening portion of the simulation. If extrema were calculated over the whole time span of the

simulation, each energization would generate identical peaks, which is useless to the designer. So, in this case, the solution is to inhibit the calculation of extrema until transients of the opening phase of execution have passed. This is possible, using a special-request card which reads as follows:

1	2	3	4	5	6	7	8	9	10	11	12	13	14	15	16	17	18	19	20	21	22	23	24	25	26	27	28	29	30	31	32	33	34	35	36	37	38	39	40
BEGIN PEAK VALUE SEARCH																																E8.0							
BEGMAX																																							

Here BEGMAX is the time in seconds at which the extrema computation is allowed to begin.

So much for the simplest possible case, where an initial time span is simply ignored in the extrema calculation. But more complex time ranges are possible, if the above BEGMAX is given a value of "-1.0". In this case, an extra card is to follow upon which monotone increasing times T1, T2, etc. are to be punched. In this case, extrema are to be calculated only for those portions of the simulation which intersect the sub-intervals (T1, T2), (T3, T4), etc. The format for this extra card is shown below, where the final subinterval is followed by some very large beginning time of a non-existent bounding interval:

E8.0	E8.0	E8.0	E8.0	E8.0	...
T1	T2	T3	T4	T5	Etc.

Temporary (initial) dimensioning has been limited to two subintervals, so either T3 or T5 is to be chosen to be a very large time (the bounding interval). For details of how to allow more such storage, see Ref. 8, Vol. XI, 20 September 1981, page MMED-1.

1.0e12 Request for "STATISTICS" Table Saving at a Specific Time

As explained in Section 1.40, Class 3a, a "STATISTICS" data case can involve the random opening of switches (rather than the more conventional random closing). The development of this capability is documented in Ref. 8, at the end of Vol. IX, 6 November 1979, page EOVN-1 and 2. Had there been sufficient time to develop this option, there would be no need for the special request of the present section. The special-request that is now to be described really just represents a patch; if EMTP tables are straightened out at some later date, it should be removed.

Well, if the user wants to manually define the simulation time at which the EMTP tables are to be saved, so that each energization need not repeat the deterministic simulation up to this point, he uses the following special-request card:

1	2	3	4	5	6	7	8	9	10	11	12	13	14	15	16	17	18	19	20	21	22	23	24	25	26	27	28	29	30	31	32	33	34	35	36	37	38	39	40
TIME OF DICE ROLL																																	E8.0						
TENERG																																							

Variable TENERG is in /BLANK/, and it is the time before which no random switching can reasonably occur. If this variable is set equal to -FLTINF in installation-dependent module "SYSDEP" of overlay one (see Section 0.5), which is the VAX and Univac usage as of March 1980, then we have the following cases:

1. If a "STATISTICS" or "SYSTEMATIC" data case is executed without a "TIME OF DICE ROLL" special-request card with reasonable positive TENERG, then internal program table dumping will be at time zero. This is done in overlay 15, at the end of "OVER15", by the call to TABLES. In this case, the deterministic portion of each energization is repeated for each random simulation. THIS IS REQUIRED FOR THE CASE OF ONE OR MORE RANDOMLY-OPENING SWITCHES, due to the aforescribed sloppy table housekeeping. But it is wasteful and unnecessary if there are no random-opening switches.

1.0e12a Declaration of Intention to Use EMTP Load Flow

EMTP load flow capability is associated with special data cards that are to follow the blank card ending sources, as explained in Section 1.66. But such observation of power constraints is optional. If such data is to be read at the appropriate time and place, the EMTP must know of its existence. The user declares this by means of the following request card:

1	2	3	4	5	6	7	8	9	10	11	12	13	14	15	16	17	18	19	20
FIX SOURCE																			

For examples of such usage, see the standard test cases BENCHMARK DC-25 and DC-26.

2. If the "TIME OF DICE ROLL" card is present in a "STATISTICS" or "SYSTEMATIC" data case, then the user defines the time at the end of the deterministic portion of all simulations at which tables can be saved. As long as there are no random-opening switches, do this, to save computer time (if TENERG is a significant fraction of TMAX).

Current (March, 1980) thinking is that all program versions to be set up during the summer of 1980 shall be this way. But there may be exceptions. The key point is the initialization of TENERG within "SYSDEP". If that negative initialization is not present, then the above does not apply. Instead, TENERG is automatically defined internally. This is fine for the case of just random closing, in this way sparing the user from defining the table-saving time himself manually. But then the random-opening case is fouled up, if the user fails to disable the automatic procedure by inputting a special-request card with TENERG negative. This would be a disaster (wrong answers to the simulation), and it is to guard against this worst case that the options of the preceding paragraph were decided upon. If there are questions about this, or if the second alternative are desired (e.g., if random opening will never, ever be used), contact Program Maintenance.

1.0e13 Request for Peak Node Voltage of Simulation

For the user who is interested in peak node voltage, but is not sure at which node this will occur, we have the paper-saving alternative requested as shown to the right:

1	2	3	4	5	6	7	8	9	10	11	12	13	14	15	16	17	18	19	20	21	22	23	24
PEAK VOLTAGE MONITOR																							

Then, at the end of the simulation, before the usual peak-value printout for the output vector, will be generated one line of output from the following statements:

```
WRITE (LUNIT6, 5011) PEAKND(1), PEAKND(2), BUS(N6)
5011 FORMAT ( 8X; 38HOVERALL SIMULATION PEAK NODE VOLTAGE =,
1 E15.6, 17H . TIME (SEC) =,
2 E14.5, 12H . BUS = ', A6, 3H' . )
```

Remember that this is the peak node voltage in volts, not in per unit. If the problem has transformers which step the voltage up or down, there is no way of spotting per unit peaks which might occur on the low voltage side.

1.0e14 Request for Allocation of Total U.M. Storage

The universal machine (U.M.) component of Section 1.63 has total working space for all tables assigned in List 25 of the overall program variable dimensioning (see Section 0.6). But there still remains the question of how this total working space is to be divided among the four U.M. tables. This allocation is performed at execution time, according to the description of this section, thanks to the procedure of variable dimensioning by arguments of a SUBROUTINE call (see Ref. 8, Vol. I, 3 July 1974, page VDTP-2 onward).

The first way to allocate total U.M. storage is with a request for absolute U.M. table sizing:

1	2	3	4	5	6	7	8	9	10	11	12	13	14	15	16	17	18	19	20	21	22	23	24	25	26	27	28	29	30	31	32	33	34	35	36	37	38	39	40	41	42	43	44	45	46	47	48	49	50	51	52	53	54	55	56	57	58	59	60	61	62	63	64
ABSOLUTE U.M. DIMENSIONS																								I8				I8				I8				I8																											
																								NCLFIX				NUMFIX				IOTFIX				IBSFIX																											

- NCLFIX ----- Maximum total number of U.M. coils in the data case. This is the total for all U.M. components involved.
- NUMFIX ----- Maximum number of U.M. components for the data case.
- IOTFIX ----- Maximum number of U.M. output quantities (total for all machines).
- IBSFIX ----- Maximum number of U.M. 6-character alphanumeric names (total for all machines).

Provided the total storage represented by this user request is less than or equal to the List 25 space available, execution will proceed in a nominal fashion. If not, this fact will be noted by module "UMOFFS" of overlay 5, as the first U.M. data component itself is ready for input, and an EMTF error stop will result. In any case, the corresponding minimum size for List 25 will be printed out by "UMOFFS" as part of the column 1-50 interpretation of the Type-19 request card for U.M. modeling. This way the user knows what fraction of the available space he is utilizing.

The second way to allocate total U.M. storage is with a request for relative sizing. That is, rather than request a specific number of coils, machines, etc., one can simply request a proportional allocation (e.g., 50% of the total storage could go for coils, etc.). The format for such an allocation is:

1	2	3	4	5	6	7	8	9	10	11	12	13	14	15	16	17	18	19	20	21	22	23	24	25	26	27	28	29	30	31	32	33	34	35	36	37	38	39	40	41	42	43	44	45	46	47	48	49	50	51	52	53	54	55	56	57	58	59	60	61	62	63	64
RELATIVE U.M. DIMENSIONS																								I8				I8				I8				I8																											
																								JNCL				JNUM				JIOT				JIBS																											

We still use integers, note; and the four data fields correspond one to one with the four tables as described for "ABSOLUTE U.M. DIMENSIONS". But here the meaning is a fraction of total available space for that table. In order to use this effectively, one must know the multiplicity of the four tables:

REAL	4	19	0	0
INTEGER	4	14	2	0
ALPHANUMERIC	0	0	0	1

For a computer with half-length integers (e.g., IBM, VAX, PRIME, and SEL, all of which use REAL*8 and INTEGER*4 translations), the overall byte weighting is: (6, 26, 1, 1). On the other hand, for a word machine where variables all have the same length (e.g., CDC), the overall word weighting is: (8, 33, 2, 1). Using whichever of these is appropriate, multiply the corresponding absolute dimensions by these components in order to produce the corresponding relative dimensions.

As an example of this, suppose that absolute dimensions that are deemed to be balanced are the default ones of the EMTF : (20, 3, 50, 60) . Well, operating at BPA on our VAX, the weighting (6, 26, 1, 1) then produces the associated relative dimensions (120, 78, 50, 60) . If the data card "RELATIVE U.M. DIMENSIONS, 120, 78, 50, 60" were then placed at the top of a data deck with involved U.M. modeling, these numbers would never have to be altered, no matter how many machines were involved. Of course, if there were too many machines for the available memory, there would be an overflow error stop. But this could be corrected by redimensioning the EMTF with larger List 25 , without touching the "RELATIVE U.M. DIMENSIONS" card.

If the user fails to input one or the other of the above two cards which specify U.M. table sizing, then the EMTF allocates absolute dimensions in "UMOFFS" of overlay 5 which equal (20, 3, 50, 60) . These, then, are default dimensions. For IBM, VAX, PRIME, and SEL, a List 25 size of 300 is sufficient for this usage (and it corresponds to the default allocation of VARDIM for List 25). Word machines will need more (it appears that 410 should do the job).

1.0e15 Request to Restart a Halted Simulation ("START AGAIN")

Integer miscellaneous data parameter MEMSAV will result in the dumping of EMTF memory onto disk at the conclusion of a simulation (i.e., at $t = T_{max}$). For those computer systems which have allowed this capability, such a simulation can be restarted, as documented in Ref. 8, Vol. X, pagination MSDO, 3 July 1980. Also see the following memo, which contains modifications. In the present material, it shall be shown how such a halted simulation can be restarted using the "START AGAIN" request.

The request to load those memory contents back from disk is of the form shown below. The request-word "START AGAIN" is universal, but the file specification that follows it will depend upon the computer system being used. Indeed, there may even be more installation-dependent information on this data card, so consult the instructions pertaining to your computer version at the front of the manual before going further. This just-described first card is to be followed by an arbitrary number of cards that redefine switch and TACS source parameters, one card per device that is to be changed. The last of these is terminated by a "9999"-card (punches in columns 5-8):

START AGAIN, file name

One card for each switch or TACS source to be changed
9999

As for the format of the cards to change parameters of switches or TACS sources, there are 5 choices:

A few additional points might be passed along as well. Between the "MISCELLANEOUS DATA CARDS" and the "TIME STEP LOOP" requests, the user is able to place any other special requests which seem appropriate. The most commonly used is "CHANGE PRINTOUT FREQUENCY", to alter the frequency of the time-step loop printout. If this is done, remember that step numbers begin where the previous halted run left off (e.g., for TMAX = 50 msec and DELTAT = 100 microsec, the first printed step would be for number 500). Yet the user should be aware that, while all requests may be accepted by the EMTP, some of the more complex ones can not possibly be honored in fact. Perhaps the best example is "RENUMBER BYPASS" of Section 1.0g4: since renumbering is to be skipped (control is transferred immediately to the time-step loop), there is no way node renumbering can be altered. Even worse are some requests which will simply make erroneous or inconsistent certain parameters of the memory contents to be restarted. An example of such a potential disaster is provided by use of the "ABSOLUTE TACS DIMENSIONS" request of Section 1.0e5. Use of this feature would alter the pointers to the TACS tables, without changing the tables themselves (which are already built), leading to "garbage out", and most likely an operating system interrupt of some sort. Hence the user is warned to be both intelligent and skeptical about any such usage; if there are some added hidden benefits, there also are some very real limits, and some hidden traps. Be cautious!

1.0e16 Request for Transfer to the Time-Step Loop

Used in conjunction with the "START AGAIN" request of Section 1.0e15, the appearance of the "TIME STEP LOOP" card will begin execution by a transfer of control to the time-step loop.

1	2	3	4	5	6	7	8	9	10	11	12	13	14	15	16	17
TIME STEP LOOP																

1.0e17 Request for Postprocessing of Plot File Using TACS

TACS can be used for the postprocessing of plot files, as described in Ref. 8, Vol. X, 3 July 1980, page MSDO-6. Yet the user is cautioned that this is installation-dependent, and will work only for those computer systems which honor a \$OLDFILE request (logic built into module "CIMAGE").

For so-equipped program versions, the procedure is summarized as follows. First connect the old plot file (input to the post processor) to LUNIT2 using \$OLDFILE:

\$OLDFILE, plot file specification , LUNIT2

Note that exact formats can not be indicated, due to the installation-dependent nature. Users should consult the specific information for their computer systems (Section 0.5a onward). As for LUNIT2, this is to be the I/O unit number that is assigned to variable LUNIT2. This will be 2 unless a system-dependent assignment within module "SYSDEP" alters the natural assignment. Variables in this plot file will be assigned to user-defined TACS sources in natural order by the EMTP, thereby providing the connection for postprocessing by the user.

Next comes the key request, as shown at the right. This is a universal card. Here "IPLOT" is to be an integer indicating frequency of the output, not unlike the miscellaneous data parameter of the same name. For example, if IPLOT = 3 is used, then only every third point of the old plot file shall be used. The most common (and least tricky) case is for IPLOT = 1, so that there are as many output points as there are input ones.

1	2	3	4	5	6	7	8	9	10	11	12	13	14	15	16	17	18	19	20	21	22	23	24	25	26	27	28	29	30	31	32
POSTPROCESS PLOT FILE,																							IPLOT								

The data case is completed by cards for a TACS-only (TACS STAND ALONE) EMTP data case. There are generally to be as many TACS sources as there are variables in the old data file, with 6-character names being arbitrary. In the order defined, these are automatically (internally) connected to variables of the old plot file. Most post-processing will involve supplemental variables, though function blocks are also useful (e.g., 1/S for integration of voltage to give flux).

1.0e18. User Supplied Switch Times

This special request allows the user to specify the random switch closing/opening times himself. To use this feature, one prepares the data the same way as for the regular statistics case except the followig two items:

1. Input a special request card "USER SUPPLIED SWITCH TIMES" before the first miscellaneous data card.

1	2	3	4	5	6	7	8	9	10	11	12	13	14	15	16	17	18	19	20	21	22	23	24	25	26	27	28	29	30	31	32	33	34	35	36	37	38	39	40
USER SUPPLIED SWITCH TIMES																																	IUNIT						
																																	18						

where IUNIT (default equals to 24) is the unit number of the file storing the user supplied switch times. The connection and disconnection of this file of switch times is installation-dependent, to be handled either externally (for VAX, using \$ASSIGN; for IBM, in the JCL), or via the installation-dependent \$ATTACH function of "CIMAGE".

2. Specify the switch closing times (TCLOSE) and opening times (TOPEN) of all the switches in a data file numbered IUNIT using 5E15.0 formats:

1	2	3	4	5	6	7	8	9	10	11	12	13	14	15	16	17	18	19	20	21	22	23	24	25	26	27	28	29	30	31	32	33	34	35	36	37	38	39	40
TCLOSE(I), I=1, KSWTCH																																							
E15.0							E15.0							E15.0							E15.0							E15.0											

1	2	3	4	5	6	7	8	9	10	11	12	13	14	15	16	17	18	19	20	21	22	23	24	25	26	27	28	29	30	31	32	33	34	35	36	37	38	39	40
TOPEN(I), I=1, KSWTCH																																							
E15.0							E15.0							E15.0							E15.0							E15.0											

Repeat this set of switching times (closing and opening) for each energization.

1.0g1 Declaration of Intention to Use Analytically-Defined Type 1-10 Sources

As explained in Section 1.6, source types 1 through 10 are reserved for functions which are directly defined by the user. If one or more such source functions is to be defined in FORTRAN within a special user-supplied version of subroutine "ANALYT", then the following special request record must precede input of the miscellaneous data cards for the data case in question:

ANALYTIC SOURCES USAGE

It is the user's responsibility to see to it that his own special module "ANALYT" has replaced the dummy one which comes with the program, when actually executing a data case which contains such an "ANALYTIC SOURCES USAGE" request.

1.0g2 Declaration of Intention to Use TACS-Defined Type 1-10 Sources.

As explained in Section 1.6, the source types 1 through 10 are reserved for functions which are directly defined by the user. If one or more such source functions is to be defined within TACS as a signal whose value is determined by the user-defined TACS data, then the following special request card must precede input of the miscellaneous data cards:

TACS EMTP SOURCES	A6	A6	A6	A6	A6	A6	A6	A6	A6	A6
	1	2	3	4	5	6	7	8	9	10
Names of TACS variables which control electric network sources having type-codes 1-10										

First, the special text "TACS EMTP SOURCES" is to be punched in columns 1-17 of the card. Then, if an EMTP electric-network voltage or current source of type-code number K (for K between one and ten) is to be controlled by TACS, the 6-character name of the controlling TACS variable is to be punched in the K-th name-field of the card. Of course any such name punched on this card must be defined as part of the TACS data specification of Section 8. (See also simpler source type 60-99 in Section 1.6)

1.0g3 Declaration of Intention to Use the "FREQUENCY SCAN" Feature

The "FREQUENCY SCAN" feature of the EMTP allows for the repetition of steady-state phasor solutions, as the frequency of sinusoidal sources is automatically incremented between a beginning and an ending frequency. Rather than conventional EMTP time-response output, the user then has available a frequency-response output. When plotted, the time axis of conventional EMTP simulations becomes the frequency axis, with the result being a Bode plot. Polar coordinates (magnitude and angle of the phasor solution variables) are used for output purposes. For example, the following could apply to the node voltage of phase "a" somewhere in the network:

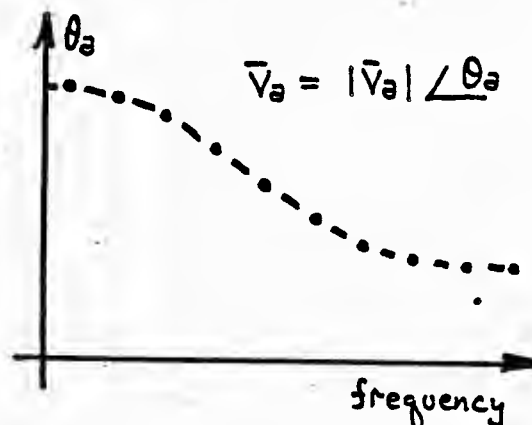
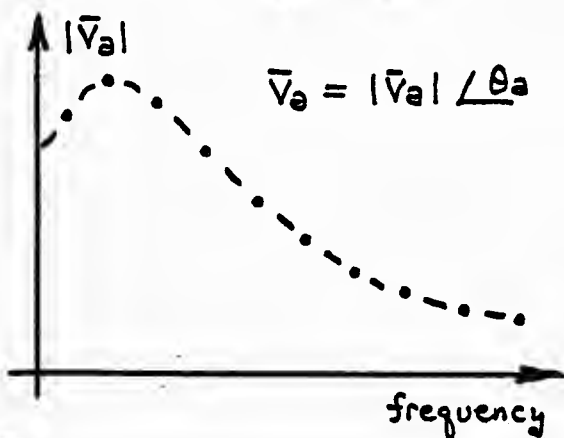

Should the user desire to make a "FREQUENCY SCAN" simulation, then the following card must precede input of the floating-point miscellaneous data card:

FREQUENCY SCAN				E8.0	E8.0	E8.0	I8
				f _{min}	Δf	f _{max}	NPD

- f_{min} ----- Beginning (minimum) frequency of the scan, in Hertz. This must be a positive number.
- Δf ----- The frequency increment, if the user wants uniform spacing between adjacent frequency points. In this case, $f_{k+1} = f_k + \Delta f$. If logarithmic (geometric) spacing between adjacent frequency points is desired, this field should be left blank.
- f_{max} ----- Terminal or end (maximum) frequency of the scan, in Hertz. This must be greater than or equal to f_{min}.
- NPD ----- For uniform spacing of the frequency points, leave this field blank. But if logarithmic (geometric) spacing is desired, this field is to be punched with the desired number of points per decade. In this case, adjacent frequency points are related by

$$f_{k+1} = (10^{1/NPD}) \cdot f_k$$

Special attention should be paid to integer miscellaneous data parameter "KSSOUT", when using the "FREQUENCY SCAN" option. See the Section 1.0h definition. If punched with unity, the full steady-state branch flow and injection printout will result, for each solution frequency of the scan. This could produce large quantities of printed output, if the number of frequency points is large. Be careful (save a tree in Oregon)!

Except for the just-mentioned full branch-flow and injection printout, only node-voltage output is presently available in the case of "FREQUENCY SCAN" data cases. Any column-80 punches for branch or switch variables (voltage differences, branch currents, powers and energies) will be disregarded by the EMTP. Node voltages are outputted in both polar (magnitude, angle in degrees) and rectangular (real, imaginary) forms.

For the LUNIT6 line printer output, there really are two component output vectors; first comes the polar part, and second (beginning at the left on a new line) comes the rectangular part. For the LUNIT4 plot file, the two are concatenated into one double-size output vector. An example of the LUNIT6 output is displayed on the following page. This output is extracted from a modified version of BENCHMARK-DC-51 (one extra node "DUMMY" was added, to produce more output, and clearly show the boundary between polar and rectangular outputs). The final line of heading (before step-1 output) shows that there are five complex output quantities, or 10 numbers total in both the polar output and the rectangular output. Prior to "M30." program versions, the output was in polar components only. For an explanation of the addition of rectangular components, see Ref. 7, Vol. XI, 5 August 1981, page MSPR-2, Point B.

For purposes of plotting, all output variables are given type code "9" (branch currents). A pair of names is associated with each number. Suppose that NODNAM is the name of the node which is of immediate interest. Then plot the "current" with names:

(NODNAM, MAG) ---- for the magnitude of node voltage NODNAM;
 (NODNAM, ANG) ---- for the associated angle in degrees.
 (NODNAM, REAL) --- for the real part of node voltage NODNAM;
 (NODNAM, IMAG) --- for the associated imaginary part.

Such plotting is illustrated by BENCHMARK DC-51, where printer plots of both polar and rectangular quantities are illustrated. For easy reference, I reproduce the two plot cards of that data case. All plotting is for steady-state voltage components versus frequency at node "CUR " :

```

    PRINTER PLOT
    19630. 60.150.          CUR  MAG  CUR  ANGLE
    19630. 60.150.          CUR  REAL  CUR  IMAG
    BLANK CARD ENDING PLOT CARDS
  
```

If the user needs branch currents, or voltage differences, he is of course free to add one or more measuring transformers for this purpose. See Section 1.25 . A 2-winding transformer which draws no magnetizing current and has small leakage impedance should of course be used, to ensure accurate measurement (just as in the real world of instrumentation). For a voltage difference, the primary would be connected across the two desired nodes; the turns ratio would be unity, and the secondary would be left open circuited, with one terminal grounded. See sketch at right.

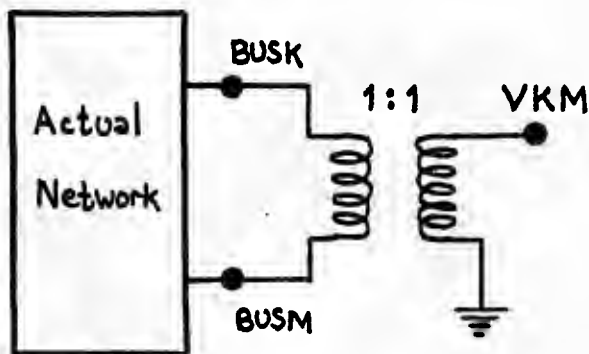

The just-described sampler of voltage difference can be easily extended to measure current. If nodes "K" and "M" are the terminals of a resistor which carries the desired current, then the measured voltage will equal the current if one uses a turns ratio of $R : 1$ (see sketch at right).

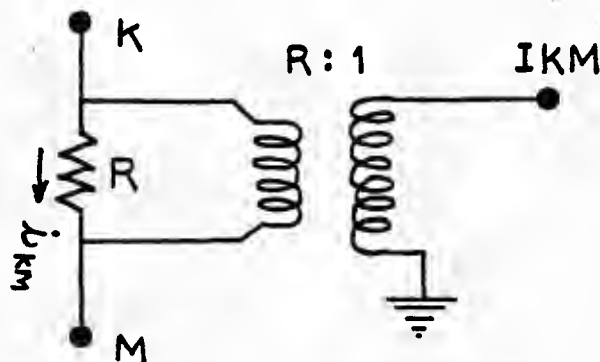

last data card of DC-51 (modified) before plot cards.

REQUEST FOR OUTPUT OF ALL NODE VOLTAGES. 1 1

THE 'FREQUENCY SCAN' OUTPUT VECTOR HAS THE FOLLOWING FORMAT. CELL NUMBER ONE CONTAINS THE FREQUENCY OF THE PHASOR SOLUTION (OR THE BASE-10 LOGARITHM OF THIS, IN THE CASE OF GEOMETRIC FREQUENCY SPACING). CELLS NUMBERED TWO ONWARD CONTAIN THE PAIRS OF MAGNITUDE AND ANGLE OF THE PHASOR NODE VOLTAGES. THESE PAIRS ARE IN THE ORDER REQUESTED BY THE USER ON THE CARD FOR SELECTIVE NODE VOLTAGE OUTPUT. FOR PLOTTING PURPOSES, THESE OUTPUT VARIABLES ARE TREATED AS THOUGH THEY WERE ORDINARY EMTF BRANCH CURRENTS (PLOT TYPE-CODE '9'). BOTH THE MAGNITUDE AND THE ANGLE USE THE ACTUAL NODE NAME FOR THE FIRST IDENTIFYING VARIABLE, AND THEN EITHER 'MAG' OR 'ANGLE' FOR THE SECOND. IN RESPONSE TO AN IREQ REQUEST DURING MAY OF 1981, RECTANGULAR OUTPUTS (USING 'REAL' AND 'IMAG' AS SECOND IDENTIFYING NAMES FOR PLOTTING) HAVE BEEN APPENDED. IN THE PRINTED OUTPUT, THIS ALTERNATE RECTANGULAR OUTPUT VECTOR FOLLOWS THE ORIGINAL POLAR ONE, WITH THE SAME NODE ORDERING (ONLY WITH 'REAL' TAKING THE PLACE OF 'MAG' AND 'IMAG' TAKING THE PLACE OF 'ANGLE'). THERE IS COLUMN ALIGNMENT (THE RECTANGULAR OUTPUT FOR ANY NODE IS LOCATED VERTICALLY BELOW THE CORRESPONDING POLAR OUTPUT). ACTUALLY, THE USER REQUESTED THE OUTPUT OF ALL NODE VOLTAGES BY MEANS OF A '1'-PUNCH IN COLUMN NUMBER TWO. IN THIS CASE, THE ORDERING OF NODES FOR OUTPUT PURPOSES IS AS FOLLOWS

← output node names, in order

OUTPUT VECTOR FOR STEP NUMBER	1	FREQUENCY =	0.600000E+02 HZ.
a {	0.100000E+03	0.9311005E+00	-0.2065694E+02
b {	0.9311005E+02	-0.2065694E+02	0.4655502E+00
	0.100000E+03	0.8712395E+00	-0.3284659E+00
	0.8712395E+02	-0.3284659E+02	0.4356197E+00
			0.1642329E+00
			0.9311005E+00
			-0.2065694E+02
			0.8712395E+00
			-0.3284659E+00

OUTPUT VECTOR FOR STEP NUMBER	2	FREQUENCY =	0.800000E+02 HZ.
	0.100000E+03	0.8890665E+00	-0.2668775E+02
	0.8890665E+02	-0.2668775E+02	0.444333E+00
			-0.2668775E+02
			0.8890665E+00
			-0.2668775E+02

: Etc.

"a" => polar half
 "b" => rectangular half
 The 3rd output name is "DUMMY",
 so the 60 Hz voltage at this
 node is

$$V_{\text{dummy}} = .4655 \angle -20.6^\circ$$

$$= .4356 + j(-.142)$$

40 - 20

1.0g4 Request for Bypass of Transient Network Renumbering

Sparsity-based node renumbering is normally used on the coefficient matrix [Y] of the time-step loop. As per Scheme 2 of Reference 4, nodes are thus renumbered so as to preserve sparsity during the triangular factorization of [Y].

But, the just-described transient node renumbering can be bypassed (omitted) if so desired, by means of the following special request card which must precede the miscellaneous data cards:

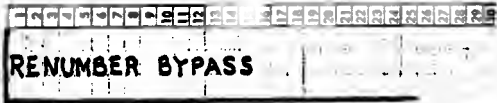

In such a case, nodes will remain numbered in the order that they will be encountered upon the reading of EMTP branch data. On any one branch card, it is the left node (data field "BUS1" of columns 3-8) which is processed before the right node (data field "BUS2" of columns 9-14).

Actually, more than just a bypass of transient network renumbering is involved. By agreement, the full [Y] is to be retriangularized whenever [Y] changes (e.g., when a switch changes status). Switch nodes and pseudononlinear element nodes are not necessarily eliminated after unknown voltage nodes which are not in this class, note. There is no partition-A triangularization outside of the time-step loop in this case. This is the whole rationale behind the use of the "RENUMBER BYPASS" feature ----- there is no artificial forcing of switch and pseudononlinear-element nodes toward the bottom of the matrix.

Use of the "RENUMBER BYPASS" feature is not recommended for beginners. In fact, its use by even old hands is rare, and is recommended only for very special big problems. One such example is a full ac/dc converter representation which might require 50 or 100 EMTP switches to represent the valves.

1.0g5 Option of linearly-varied bias for Monte Carlo Studies

At the request of BPA production users (specifically, Dan Goldsworthy), the normally random or zero bias that can be added to all switch times of Monte Carlo studies can be replaced by a linear variation. This will be the program response to the request:

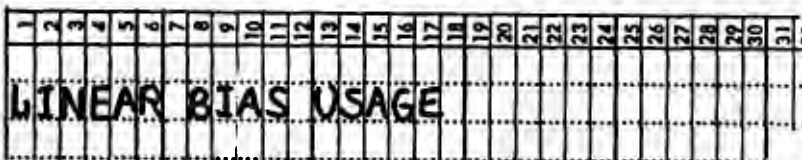

No further information is required, since limits on the bias have already been provided by the "STATISTICS" miscellaneous data parameters DEGMIN and DEGMAX (see Section 1.1a, columns 41-56). For a case with "LINEAR BIAS USAGE", there is replacement of the random number that normally is used by a variable that varies linearly between 1.0 / NENERG and unity as the NENERG energizations are performed.

1.0g6 Re-Definition of Free-Format Data-Field Delimiters

As explained in Section 0.7 , certain classes of EMTF data may be punched either according to the conventional fixed-format specifications, or using the newer free-format option. This latter mode makes use of two special alphanumeric characters : one which separates data fields, and one which requests a continuation card. Should the user want to re-define one or both of these characters, a data card in the following format should be punched, and should precede the miscellaneous data cards:

FREE FORMAT	A8	A8
CSEPAR	CHCONT	

CSEPAR ---- The single alphanumeric character which is to serve as separator between adjacent data fields. Punch this character left-adjusted in the field shown (i.e., in column 17). Mnemonically, the name signifies "Character SEPARator". If left blank, a comma (",") will be assumed; if no such redefinition card is present, a comma will be assumed.

CHCONT ---- The single alphanumeric character which is to serve as a request for a continuation data card. Punch this character left-adjusted in the field shown (i.e., in column 25). Mnemonically, the name signifies "CHaracter CONTInuation". If left blank, a "\$" sign will be assumed. Remember that this must be a special character which the user will never employ as part of his non-comment EMTF data cards.

If the user wants all data cards of the data case in question to be read using fixed formats, he should enter "9" (nine) for "CHCONT". By definition, this will bypass all attempts at free-format data reading (except for the free-format FORTRAN expression in TACS), and will thus speed up input slightly. It will also guard against possible confusion of the fixed-format data with free-format recognition rules.

As of April of 1980, the free-format option has been implemented for most EMTF data structures. But there are important exceptions, so it should be used with caution and considerable skepticism only.

The reason for incomplete implementation can be blamed on existing EMTF logic which uses two or more DECODEs of a data card image. For the first DECODE, which EMTF usage typically begins at the left edge of the card, there is no ambiguity. But for the second and later ones, it is sometimes impossible or impractical to determine how many data fields have preceded it. EMTF logic simply is not so component-oriented (it is more table-oriented). The column-80 punch for branch current is a classic example, and my recollection is that this must remain as a fixed-format punch, even if the rest of the data card is free-format. Switch cards likewise suffer from this multiple-DECODE problem. There is no simple rule for knowing which data structures work with free-format usage, and it is impractical to tabulate an exhaustive list. I can only recommend skepticism and caution.

But an even more fundamental reason for not completing the free-format work is that the resultant data has been judged to have unacceptable reduced readability. For small data cases, this is not a serious problem. But with hundreds of data cards, where the user forgets the modeling details or even the extent, readability is most important. Column positioning of the nonzero data is an important element in allowing for the rapid visual scanning and interpretation of EMTF data cards. The counting of commas becomes impossibly slow and error prone (e.g., an inductor and a capacitor are distinguished by only one comma in a string of several). Yes, we need free-format capability for use with CRT terminals, but current thinking is that it will not be of the simple-minded type described in this section. One idea under consideration is that of data tags (see ref. 8, Vol. IX, 6 August 1979, page FYIM-8, Project 2). Another idea is to write a special program which would assemble the fixed-format data records based on data which is supplied in various free-format pieces (thereby preserving readability for future use). Something will be done, though we are only talking about it today.

An important property of free-format numbers is that there is no distinction between integers and reals ("I" vs. "E" data fields). In fact, all numbers are extracted from the data card as reals, with a mode conversion subsequently used if the EMTF expected an integer.

The appearance of either "CSEPAR" or "CHCONT" characters (which have default values "," and "s", respectively) on a data card is the sole determiner as to whether the card uses free format. Thus, it is imperative that these two characters not be buried in A6 names like bus names, or TACS variable names. As a general rule for staying out of trouble, I recommend the "CSEPAR" and "CHCONT" not be redefined without very good reason, and that users simply never use commas or dollar signs in A6 names. This assumes that the user has not disabled free-format capability (easily done within installation-dependent module "CIMAGE"; see Section 0.5 for location), or that he does not always define "CHCONT" equal to "9".

The summary recommendation from Portland is that users stay away from the free-format usage, if possible. Being forced to enter EMTF data through a computer terminal is not a sufficiently strong reason for the use of free-format capability in the general case. All BPA data is so created, yet BPA production users still employ fixed-formatting. There should be a really overpowering reason, like the need for more precision, before it is recommended that the average user try his hand at free formatting. There simply are too many problem cases, too many things that can go wrong.

1.0g7 Request for Selective Diagnostic Printout

Parameter "IPRSUP" of the integer miscellaneous data card (Section 1.0h) will turn diagnostic printout on or off irrespective of the location of that printout within the program. That is either all printout is turned on, or all is turned off, at a certain threshold level. If positive, "IPRSUP" will override the selective printout request of this present section.

But if "IPRSUP" is to be punched zero or blank, then the EMTF diagnostic printout can be controlled overlay by overlay. A special-request card bearing the key word "DIAGNOSTIC" in columns 1-10 is used in this case. The following format is applicable for this card which must precede the miscellaneous data cards:

DIAGNOSTIC	1	2	3	4	5	6	7	8	9	10	11	12	13	14	15	16	17	18	19	20	21	22	23	24	25	26	27	28	29	30
	(IPRSOV(I), I=1,30) ;															12 format														

IPRSOV(K) ---- diagnostic printout control parameter as restricted to overlay number "K". Within overlay "K", IPRSOV(K) has the same meaning as "IPRSUP" described in Section 1.Ch.

For overlays "K" which exceed 30, IPRSOV(K-30) is used to control the diagnostic printout. That is, only 30 distinct codes have been provided for, with these being reused cyclically for higher overlay numbers.

In the selection of these diagnostic-printout codes, special care should always be taken with regard to the time-step loop, which is overlay number 16. Remember that diagnostic printout can be generated for each time step, so beware of the termination time "TMAX" in relation to the step-size "DELTA", should such printout be requested. Another consideration is for large networks, which will heavily impact on overlay number 7 (network node-renumbering). Here printout can be produced for each row of the matrix.

As a general rule, always consult with Program Maintenance if in doubt about the control of diagnostic printout. "Save a tree in Oregon."

Control of diagnostic printout for the time-step loop code of overlay 16 deserves further explanation. Actually, it is broken into four principal modules: SUBTS1, SUBTS2, SUBTS3, and SUBTS4. Printout control parameter IPRSOV(16) applies to the first of these (SUBTS1), 17 applies to the second, 18 applies to the third, and 19 is for the last (SUBTS4). Since the time-step loop is followed by UTPF overlay number 20, there is no contradiction or confusion in this usage.

If diagnostic printout is being turned off and on as a function of time (see Section 1.1b, with a minus sign on MULT), then (IPRSOV(J), J=16, 19) alternate with (IPR(J), J=1, 4) for control of diagnostic printout of the time-step loop. There are two distinct cases:

Case 1: If the user wants to start with no diagnostic (Step zero or one), then IPRSOV(16) through IPRSOV(19) should all be zero, and the "ALTERNATE DIAGNOSTIC PRINTOUT" request of Section 1.0g8 should be used to define the nonzero printout codes (one or more nonzero).

Case 2: If the user wants to start with diagnostic (Step zero), then IPRSOV(16) through IPRSOV(19) should not all be zero. In this case, no "ALTERNATE DIAGNOSTIC PRINTOUT" request is needed, since zero values are the default.

1.0g10 Request for 80-column Output of Many UTPF Printout Structures

Either because one only has available an 80-column computer terminal, or because one wants to save paper, or speed the output (by less printing), he can switch to 80-column output (rather than the more common 132-column output) by means of an "OUTPUT WIDTH 80" request. The philosophy behind this decision, as well as a sample of such output for phasor branch flows, is contained in Ref. 8, Vol. XI, 6 February 1982, Section I, pages ECEO-1 and 2.

In the absence of such a request, EMTF printout will normally be 132 columns ---- unless Program Maintenance for the computer system of interest has inserted a statement `KOL132 = 80` in installation-dependent SUBROUTINE SYSDEP of overlay 1. As of March 1983, however, no systems are doing this.

Use of 80-column output has some serious limitations which should be understood. First, the interpreted tabulation of input data cards, as well as the connectivity table, will be truncated at column 80, and all output to the right of this point will simply be lost. Second, not all displays any longer convey full information. For example, the phasor branch flows are now only in polar coordinates, for the near end of the line. Case summary statistics now only display PRESENT SIZE figures and computer times, without the voluminous associated English language text. Etc. If in doubt, try the feature on a small problem, and see if the output is satisfactory.

The request "OUTPUT WIDTH 80" is a single-time request which then would normally remain in effect for the entire EMTF solution. But there are times when the output width might profitably be switched between 80 and 132 columns at different points of the EMTF execution. This is generally possible via the universal dollar card \$WIDTH as described in Section 1.-D (serviced by installation-dependent "CIMAGE").

1	2	3	4	5	6	7	8	9	10	11	12	13	14	15	16	17	18	19	20	21	22	23
OUTPUT WIDTH 80																						

1.0g11 Request for 132-column Output of Many UTPF Printout Structures

There is need for an "OUTPUT WIDTH 132" request only if Program Maintenance for the computer system of interest has for some reason decided that 80-column output will be standard (via a `KOL132 = 80` statement within installation-dependent SUBROUTINE SYSDEP). See Section 1.0g11 for further explanation.

1	2	3	4	5	6	7	8	9	10	11	12	13	14	15	16	17	18	19	20	21	22	23
OUTPUT WIDTH 132																						

1.0g12 Request for Different Switch Logic

Provided Program Maintenance for the computer system of interest has not set `KTRLSW(6) = 1` within installation-dependent SUBROUTINE SYSDEP of overlay 1, few if any program users should have use for a "MODIFY SWITCH LOGIC" request. The value `KTRLSW(6) = 0` set near the top of universal "OVER1" gives simple switch logic ---- generally best.

The motivation behind two different switch logics was summarized in Ref. 22, Vol. 2, No. 4, pages 36-42, and Vol. 3, No. 1, pages 70-74 (Specifically Section III on page 73). The simple logic works so well that program default is set this way (no KTRLSW(6) = 1 definition of "SYSDEP") for all computers known to WSM as of March 1983 as this text is being frozen for publication. All but the most esoteric of hvdc experiments are advised to keep it this way.

1	2	3	4	5	6	7	8	9	10	11	12	13	14	15	16	17	18	19	20	21	22	23
MODIFY SWITCH LOGIC																						

1.0g13 Request for Constant-Parameter Generator Equivalent Routine

During the summer of 1982, WSM worked with Dan Goldsworthy (a BPA production user of the EMTP) on a routine which would calculate Thevenin impedances for a user who knew short-circuit currents at the busses of interest. The result was a 428-line SUBROUTINE FLTDAT (mnemonically, "FAULT DATA"), which for convenience was added to overlay 29, to be CALLED if and only if blank COMMON flag ISTEP = 6633 is set. This in turn is the response to the request word "FAULT DATA USAGE" which is of concern in this section.

It was the intention of Dan and WSM to jointly write a Newsletter article on the theory and usage of "FLTDAT", but this was not possible before WSM's trip to the Orient at the start of October. Nor has it been possible since, thus far. But the intention has not been abandoned, and once that background material has been completed, it should be relatively easy to complete the explanation of "FAULT DATA USAGE". But until that is done, nothing more in this present section shall be attempted. The current date is 22 March 1983.

1	2	3	4	5	6	7	8	9	10	11	12	13	14	15	16	17	18	19	20	21	22	23
FAULT DATA USAGE																						

1.0g14 Request to Redefine Limit on Number of TACS Warning Messages

Although the origins and intended operation no longer remain clear, we shall document the special request word "TACS WARN LIMIT" which can be found in the universal SUBROUTINE REQUES of overlay 1. This is not functional today, but could and should be expanded in the future. The present section should serve as a reminder of needed future program work.

The idea as best I can remember it on 22 March 1983 is simple: There are special cases where certain TACS warning messages are a nuisance. My recollection is that Vladimir objected to one from the frequency sensor, which apparently appeared many times during the course of hvdc start up. As he pointed out, the complaint had no meaning for his use, so it was unsightly and aggravating at best, and misleading at worst. On the other hand, I pointed out that the putting of such a message under normal DIAGNOSTIC control (Vladimir's solution, as I recall) could be dangerous. I decided to force the user to explicitly request the suppression of TACS warning messages via a "TACS WARN LIMIT" card --- but apparently never did anything outside of "REQUES".

1	2	3	4	5	6	7	8	9	10	11	12	13	14	15	16	17	18	19	20	21	22	23
TACS WARN LIMIT																						

1.0g16 Request to Convert ZnO Branch cards from Old to New Formats

With this special request card "CONVERT ZNO", the program will convert the "old" ("M36." or earlier vintage) Zinc Oxide arrester branch data into the "new" formats as required for "M38." and later versions of the EMTP.

1	2	3	4	5	6	7	8	9	10	11	12	13	14	15	16	17	18	19	20	21	22	23
CONVERT ZNO																						

To use this feature, one should add this special request card "CONVERT ZNO" before the first miscellaneous data card of the old data deck. The new ZnO arrester branch cards are outputted on LUNIT7. User then should replace the old ZnO branch cards by the new ones generated on LUNIT7 and remove the special request card "CONVERT ZNO" added earlier. To illustrate this, an example is given in the following:

- (1) Add special request card "CONVERT ZNO" to an old ZnO data case:

```

BEGIN NEW DATA CASE
CONVERT ZNO ! special request card to convert ZnO old data
C BENCHMARK DC-38B
C TEST OF SINGLE-EXPONENTIAL, NO-GAP, ZINC-OXIDE SURGE ARRESTER
C MODEL AS DESCRIBED IN SECTION 1.32 OF THE EMTP RULE BOOK.
C UNLIKE PRECEDING PROBLEM WHICH USED SINGLE-PHASE COMPENSATION,
C THIS ONE USES 3-PHASE COMPENSATION FOR THE THREE IDENTICAL
C ARRESTERS AT THE END OF THE 200-MILE OVERHEAD TRANSMISSION LINE
C (MODELED AS DISTRIBUTED, WITH CONSTANT PARAMETERS).
C 3-PHASE ZNO SURGE ARRESTER EXAMPLE TAKEN FROM ISSUE NO. 2 OF
C EMTP NEWSLETTER (SEE THIS ARTICLE FOR FULL DESCRIPTION).
Z0,20,,,,,9,,
.000050 .020000
      1      1      1      0      1      -1
      5      5      20     1      30     5      50      50
-1SENDA RECA .305515.8187.01210 200. 0
-2SENDB RECB .031991.5559.01937 200. 0
-3SENDC RECC
C 34567890123456789012345678901234567890
    
```

```

92RECA          5555.
-1.             -1.             Old ZnO data formats
 1.             1.
 9999.
92RECB          RECA          5555.
92RECC          RECA          5555.
BLANK CARD ENDING BRANCH DATA.
BLANK CARD ENDING SWITCH DATA.
14SEND A        408000.        60.          0.0
14SEND B        408000.        60.         -120.
14SEND C        408000.        60.          120.
BLANK CARD ENDING SOURCE CARDS.
C 345678901234567890123456789012345678901234567890123456789
C the following 3 cards are part of the ZnO data using the old formats
-1 2500.         26.           0.5             778000.
-1 2500.         26.           0.5             778000.
-1 2500.         26.           0.5             778000.

```

```

1
PRINTER PLOT
144 3. 0.0 20.          RECA
BLANK CARD ENDING PLOT CARDS.
BEGIN NEW DATA CASE
BLANK

```

(2) The new ZnO branch cards generated on LUNIT7 after running the above data deck with "M39." EMTF are as follows:

```

92RECA          5555.
0.7780000000000000E+06 -0.1000000000000000E+03 0.0000000000000000E+00
0.2500000000000000E+04 0.2600000000000000E+02 0.5000000000000000E+00
9999
92RECB          5555.
0.7780000000000000E+06 -0.1000000000000000E+03 0.0000000000000000E+00
0.2500000000000000E+04 0.2600000000000000E+02 0.5000000000000000E+00
9999
92RECC          5555.
0.7780000000000000E+06 -0.1000000000000000E+03 0.0000000000000000E+00
0.2500000000000000E+04 0.2600000000000000E+02 0.5000000000000000E+00
9999

```

(3) Replace the old ZnO branch cards in (1) by the new ones shown in (2), and remove the "CONVERT ZNO" special request card in (1), one then obtains the data deck with the correct new formast as required by "M39." EMTF:

```

BEGIN NEW DATA CASE
C BENCHMARK DC-38B
C TEST OF SINGLE-EXPONENTIAL, NO-GAP, ZINC-OXIDE SURGE ARRESTER
C MODEL AS DESCRIBED IN SECTION 1.32 OF THE EMTF RULE BOOK.
C UNLIKE PRECEDING PROBLEM WHICH USED SINGLE-PHASE COMPENSATION,
C THIS ONE USES 3-PHASE COMPENSATION FOR THE THREE IDENTICAL
C ARRESTERS AT THE END OF THE 200-MILE OVERHEAD TRANSMISSION LINE
C (MODELED AS DISTRIBUTED, WITH CONSTANT PARAMETERS).
C 3-PHASE ZNO SURGE ARRESTER EXAMPLE TAKEN FROM ISSUE NO. 2 OF
C EMTF NEWSLETTER (SEE THIS ARTICLE FOR FULL DESCRIPTION).
Z0,20,,,,.9,,
.000050 .020000
 1 1 1 0 1 -1
 5 5 20 1 30 5 50 50

```

-1SENDA RECA .305515.8187.01210 200. 0
 -2SENDB RECB .031991.5559.01937 200. 0
 -3SENDC RECC

C 34567890123456789012345678901234567890

92RECA 5555.
 0.7780000000000000E+06 -0.1000000000000000E+03 0.0000000000000000E+00
 0.2500000000000000E+04 0.2600000000000000E+02 0.5000000000000000E+00
 9999

92RECB 5555.
 0.7780000000000000E+06 -0.1000000000000000E+03 0.0000000000000000E+00
 0.2500000000000000E+04 0.2600000000000000E+02 0.5000000000000000E+00
 9999

92RECC 5555.
 0.7780000000000000E+06 -0.1000000000000000E+03 0.0000000000000000E+00
 0.2500000000000000E+04 0.2600000000000000E+02 0.5000000000000000E+00
 9999

BLANK CARD ENDING BRANCH DATA.

BLANK CARD ENDING SWITCH DATA.

14SENDA 408000. 60. 0.0
 14SENDB 408000. 60. -120.
 14SENDC 408000. 60. 120.

BLANK CARD ENDING SOURCE CARDS.

C 3456789012345678901234567890123456789012345678901234567890123456789

1

PRINTER PLOT

144 3. 0.0 20. RECA

BLANK CARD ENDING PLOT CARDS.

BEGIN NEW DATA CASE

BLANK

1.0g17 Request to Redefine Controls of ZnO Newton Iteration

The average ZnO surge arrester modeling can use default parameters to control the Newton iteration without difficulty. But sometimes the Newton iteration fails to converge, and then recourse should be made to special controls by means of the following request:

1	2	3	4	5	6	7	8	9	10	11	12	13	14	15	16	17	18	19	20	21	22	23	24	25	26	27	28	29	30	31	32	33	34	35	36	37	38	39	40	41	42	43	44	45	46	47	48	49	50	51	52	53	54	55	56	57	58	59	60	61	62	63	64						
ZINC OXIDE										MAXZNO										EPSZNO										EPWARN										EPSTOP										ZLIM ₁										ZLIM ₂									
IS										E8.0										E8.0										E8.0										E8.0										E8.0																			

Rather than explain such information here, however, the reader is referred to the end of Section 1.32-A, where the explanation was erroneously placed years ago.

1.0h Miscellaneous Data Parameter Cards

The first non-comment card which fails to be recognized as any of the preceding special request types will be taken to be the beginning of "regular data" for a conventional EMTP data case. This regular data begins with two miscellaneous data cards ---- first one card for floating-point parameters, and then one for integers, as follows:

First misc. data card (floating-point misc. data)

1	2	3	4	5	6	7	8	9	10	11	12	13	14	15	16	17	18	19	20	21	22	23	24	25	26	27	28	29	30	31	32	33	34	35	36	37	38	39	40	41	42	43	44	45	46	47	48	49	50	51	52	53	54	55	56
DELTAT								TMAX								XOPT								COPT								EPSILN								TOLMAT								TSTART							
E8.0								E8.0								E8.0								E8.0								E8.0								E8.0								E8.0							

where

DELTAT ---- The time-step size Δt of the numerical integration, in sec.
(1-8) The solution will be calculated at time instants with this spacing: $t=0, \Delta t, 2\Delta t,$ etc. seconds.

TMAX ---- The termination time T_{\max} of the study, in seconds.
(9-16) The simulation thus covers time interval $0 \leq t \leq T_{\max}$

XOPT ---- Parameter indicating whether inductance or inductive-reactance
(17-24) is to be inputted on all linear branch cards:

$$\left\{ \begin{array}{l} 0 \Rightarrow \text{All inductance values on branch cards are} \\ \text{interpreted as } L \text{ in mH (millihenries).} \\ f \Rightarrow \text{All inductance values on branch cards are} \\ \text{interpreted as } \omega L = 2\pi f L \text{ in } \Omega \text{ (ohms)} \\ \text{at frequency } f = \text{XOPT.} \end{array} \right.$$

COPT ---- Parameter indicating whether capacitance or capacitive reactance
(25-32) is to be inputted on all linear branch cards:

$$\left\{ \begin{array}{l} 0 \Rightarrow \text{All capacitance values on branch cards are} \\ \text{interpreted as } C \text{ in } \mu\text{F (microfarads).} \\ f \Rightarrow \text{All capacitance values on branch cards are} \\ \text{interpreted as } \omega C = 2\pi f C \text{ in } \mu\text{V} \\ \text{(micromhos) at frequency } f = \text{COPT.} \end{array} \right.$$

EPSILN ---- Near-zero tolerance ϵ , used for checking singularity of
(33-40) the real coefficient matrix $[G]$ within the time-step loop,
where $[G] \vec{v}_{\text{node}}(t) = \vec{i}_{\text{node}}(t)$

A blank or zero field is given a default value which is dependent upon the translation being used. With 36-bit floating-point words (single-precision Univac and Honeywell/GE), a default value of 1.E-5 is common; the 60-bit CDC and 64-bit IBM (REAL*8) versions are commonly given default values of 1.E-8.

TOLMAT ---- A second near-zero tolerance, used for checking singularity
(41-48) of the steady-state phasor (complex) admittance matrix $[Y]$.
A blank or zero field is given default value equal to whatever 'EPSILN' happens to be.

TSTART ----- The beginning simulation time. This will normally be zero (the data field can be left blank). If a previously-solved data case is to be restarted, however, then this field must be punched with the terminal (ending) time of that preceding partial simulation.

Second misc. data card (integer misc. data card)

IOUT	IPLLOT	IDOUBL	KSSOUT	MAXOUT	IPUN	MEMSW	ICAT	NENERG	IPRSUP
18	18	18	18	18	18	18	18	18	18

IOUT ----- Parameter providing control over the frequency of the printed transients simulation:
(1-8)

$\left. \begin{array}{l} 0 \\ 1 \end{array} \right\} \Rightarrow$ Output quantities are printed for every time step.
 $K \Rightarrow$ For $K > 1$, results are printed for every K -th step only; that is, for times $t = 0, (K \Delta t), (2K \Delta t), (3K \Delta t), \dots$ etc.

IPLLOT ----- Parameter providing control over the frequency of the plotted transients simulation:
(9-16)

$\left. \begin{array}{l} 0 \\ 1 \end{array} \right\} \Rightarrow$ Every computed point will be used for plotting.
 $M \Rightarrow$ For $M > 1$, only every M -th computed point will be used for plotting. This saves plotting time and reduces storage requirements if, for some reason, a smaller step-size is needed for solution than for graphical output. If the user should punch an even value for M , the program will automatically increment it by one, to make it odd. This is because even values will produce deceptive results for an oscillating curve, graphing only the upper or lower envelope.
 $-1 \Rightarrow$ No plotting is possible, as no permanent file of plot values is created. Use this option if no plots are desired, in order to speed execution.

IDOUBL ----- Parameter controlling the printing of a network connectivity table, showing how branches and switches topologically interconnect the network busses.
(17-24)

$\left. \begin{array}{l} 0 \\ 1 \end{array} \right\} \Rightarrow$ No such output is provided.
 $1 \Rightarrow$ A printout of network connectivity is provided. For each node, a list is given of the nodes to which it is connected through physical branches and switches. Mutual coupling between phases of multiphase elements is ignored in this output, as is the capacitance to ground of Pi-circuits and distributed-parameter lines. Since the node name " " (6 blank characters) which normally signifies ground would not show up in print, the word "TERRA" or "TERRA FIRMA" is used in the connection list.

KSSOUT ----- Parameter controlling the printout of all linear-branch line flows, switch flows, and all voltage-source injections, for the steady-state phasor network solution:

- 0 \Rightarrow No steady-state solution printout.
- 1 \Rightarrow Print complete steady-state solution (branch flows, switch flows, source injections).
- 2 \Rightarrow Print switch flows, source injections; but not branch flows.
- 3 \Rightarrow Print branch flows requested by column 80 punches, switch flows and source injections.

MAXOUT ----- Parameter controlling the printout of maximum absolute values of all output variables, the maximums which occurred during the simulation:

- 0 \Rightarrow No such output
- 1 \Rightarrow Print the maximums, as calculated using every time step.
- 2 \Rightarrow Print the maximums, as calculated using only the time steps t_i for which the output solution vector must be formed for printing or plotting. If the user's branch cards carry a power or energy-output request, every time-step is automatically used. though.

IPUN ----- Parameter controlling the punching of terminal conditions of the simulation (at time $t = TMAX$):

- 0 \Rightarrow No such punching.
- 1 \Rightarrow Node voltages and branch currents (plus capacitor voltage on series R-L-C branches) at the last time step are punched on cards; these can be used as initial conditions for other studies starting from this state of the system. The present version of the program interrupts punching if a branch with distributed parameters is encountered; in this case, a message "PUNCHING OF CURRENTS STOPPED BECAUSE INFORMATION INSUFFICIENT IN THE PRESENCE OF DISTRIBUTED PARAMETERS" is printed. The transient state of a branch with distributed parameters would have to be defined by the entire voltage and current profile along the line; this causes complications in the input/output phases, which have not yet been incorporated.
- 1 \Rightarrow An extra, special card will immediately follow this second misc. data card, to vary the printout frequency as described in Section 1.1 . See also Section 1.0e10 .

MEMSAV ---- Parameter controlling the dumping of memory onto disk at
(49-56) the end of the simulation (time TMAX), for subsequent use
with the "START AGAIN" request of Section 1.0e15 :

- { 0 ⇒ No such memory saving will occur.
 { 1 ⇒ Yes, save the memory contents for later use.

WARNING! The dumping of memory onto disk in this way is an installation-dependent feature which has not been implemented on all computer systems. Modules KATALG and PFATCH are involved (see Section 0.5). Consult the installation-dependent information for your computer system at the beginning of this manual, if in doubt.

RESTRICTION : The "START AGAIN" reactivation of a previously-halted simulation can only be guaranteed if the same EMTP version is used. An internal check is made on the size of /BLANK/ and /LABEL/ , with an EMTP error stop resulting if these figures do not match for the two program versions. The dimensioning must be identical, then.

ICAT : ---- Parameter which controls the permanent disk storage of plot
(57-64) data points which are accumulated on logical unit number 4 during the simulation:

- { 0 ⇒ No permanent storage will be provided, though conventional batch-mode plotting at the conclusion of the solution process is possible. But once the computer job ends, the plot file will be lost.
 { 1 ⇒ Permanent storage of the plot data file will be provided at the conclusion of the solution process; these will be cataloged on the disk using the date and the time (MM/DD/YY HH.MM.SS) when the data case began execution (see initial line-printer output of a data-case solution). No conventional batch-mode plotting of the results in this case will be allowed (the T.P. will skip over plot cards, discarding them until it finds the blank card which terminates plot cards).
 { 2 ⇒ Combination of the above. That is, the plot data file is saved on disk for later re-use, plus, conventional batch-mode plotting requests are honored.

WARNING! The saving of plot data points on disk is an installation-dependent feature which has not been implemented on all computer systems. Modules KATALG and PFATCH are involved (see Section 0.5). Consult the installation-dependent information for your computer system at the beginning of this manual, if in doubt. The practical production use of such files is for CRT plotting (see description of Section 5.).

NENERG ----- Control parameter related to the running of multiple-energization studies (either "STATISTICS" or "SYSTEMATIC").
(65-72)

0 \Rightarrow Conventional, single, deterministic T.P. simulation is desired; no dice rolling!

K \Rightarrow For $K > 0$, this is a request for a statistical study of this data case, in which K energizations (switch closings) will be performed.

For $K < 0$, this is a request for a systematic study of this data case, in which $|K|$ energizations will be performed.

See the section on switch cards for a complete discussion of such studies (both "STATISTICS" and "SYSTEMATIC"). Should "NENERG" be punched nonzero, an added special statistics or systematic miscellaneous data card must follow, giving necessary scalar parameters for the study.

IPRSUP ----- Parameter controlling the output of program diagnostic printout.
(73-80) Production runs should always leave this field blank (or punch a zero). Beware of astronomical paper requirements in using this capability; use only with understanding, or upon the advice of program maintenance.

0 \Rightarrow there will be no diagnostic printout, unless such was selectively requested using the "DIAGNOSTIC" key-word card of Section 1.0g7 .

M \Rightarrow For increasingly-positive "M", more and more diagnostic printout will be generated. Such a positive "M" over-rides any selectively-requested diagnostic printout (key-word "DIAGNOSTIC").

Sinusoidal steady-state solution output

In order to determine initial conditions for starting the transients solution, a single-frequency, sinusoidal, steady-state solution is automatically calculated by the Transients Program. This produces a phasor solution to the linear network which the user inputted ---- linear because all nonlinear elements are either disconnected during the solution, or are assumed to operate in their normal linear range.

Excitation for these solutions consists of only sinusoidal sources (Type 14 sources of Section 1.6) for which $TSTART < 0$ has been punched. Solution is only for a single frequency f_{STEADY} , that frequency read from the first Type 14 source card. All Type 14 sources within $\pm 1\%$ of this frequency are used; all others are ignored during the steady-state solution.

$$\begin{array}{c} | \\ \text{---} \\ | \\ R \\ | \\ \text{---} \\ | \end{array}$$

$$v = Ri$$

$$\Downarrow$$

$$\bar{V} = R\bar{I}$$

$$\begin{array}{c} | \\ \text{---} \\ | \\ L \\ | \\ \text{---} \\ | \end{array}$$

$$v = L \frac{di}{dt}$$

$$\Downarrow$$

$$\bar{V} = j\omega L \bar{I}$$

$$\begin{array}{c} | \\ \text{---} \\ | \\ C \\ | \\ \text{---} \\ | \end{array}$$

$$i = C \frac{dv}{dt}$$

$$\Downarrow$$

$$\bar{I} = j\omega C \bar{V}$$

If the user is interested in printout of the above steady-state solution, he has two options:

- a) Complete Solution. By punching a "1" in column 32 of the Integer Misc. Data Card (Section 1.0h; the 2nd miscellaneous data card), complete printout of the flows in all network branches is produced. The printout includes complex currents and powers, as well as terminal voltages for the two ends of each branch, in both rectangular and polar form.
- b) Transients variables only. By setting T_{max} of the Floating-Point Misc. Data Card to be non-positive (see Section 1.0h; columns 9-16 of the first miscellaneous data card), the EMTP will never reach the transients mode in solving the data case. Rather, the steady-state solution is found, and then a special phasor printout of only those variables normally printed during the transient run (see Section 1.8) occurs. The case is then terminated following this printout.

Note that following the output of option a), a transient solution to the network is allowed. Also, either, both, or neither steady-state printout can be requested, since they are independent. See Section 2.2 for sample output of this type.

The formula used for the power flow calculation is $P + jQ = V \cdot I^* / 2$. Hence it is implicitly assumed that sources are specified in peak, and not in rms, terms. Such a use of peak quantities will be found to be consistent with source-input rules of Section 1.6. For example, a nominal Wye-connected voltage source for 500kV would have amplitude $500 \sqrt{2/3} = 408248$ volts. With sources given in volts and amps, power then comes out in watts or vars.

The complete steady-state solution output provides printout on the extreme right of the page for power loss, branch by branch (see example of Section 2.2). Assuming that the branch in question connects nodes k and m as shown, then by definition, the program prints out the following:

$$P_{\text{loss}} + j Q_{\text{loss}} = (P_{km} + P_{mk}) + j (Q_{km} + Q_{mk})$$

For simple series R-L-C branches, this is indeed the true loss figure for the branch ---- the heating loss (considering real power only) in resistance of the branch.

But for distributed-conductor or Pi-equivalent branches, the loss figure so printed is not really loss at all; it is simply the sum of the power inputs at the two ends.

BEWARE!

Conservation of energy dictates that power in equals power out. But only if terminals k and m were the only connection to branch (k,m) would the printout actually give true branch loss. But mutual coupling (capacitive and/or inductive) between branch (k,m) and other branches provides additional paths for power entry and/or exit (see Fig. 2). Thus adding the k-to-m and the m-to-k powers does not provide loss.

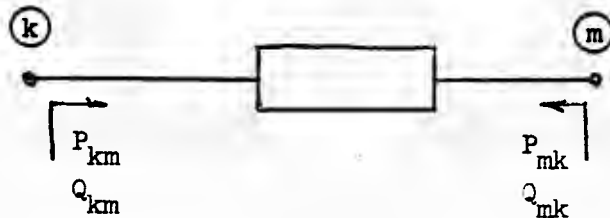

Fig. 1. Branch (k,m)

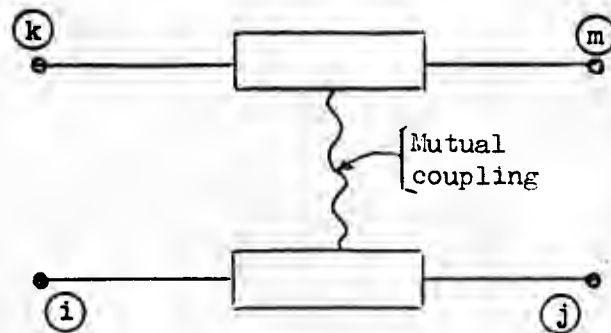

Fig. 2. Mutual coupling with branch (k,m) may be present.

CONCLUSION: With distributed or Pi-equivalent branches, do not interpret the printed loss figure (P or Q) of the complete steady-state solution printout as loss attributable uniquely to the branch in question. The one exception to this warning is in the single-phase (uncoupled) case, where there is no problem.

A sample of the complete steady-state solution printout is shown below. This begins with branch flows, as follows:

SINUSOIDAL STEADY STATE SOLUTION, BRANCH BY BRANCH. ALL FLOWS ARE AWAY FROM BUS, AND REAL PART, MAGNITUDE, OR P IS PRINTED ABOVE THE IMAGINARY PART, THE ANGLE, OR Q. SOLUTION FREQUENCY = .600000000E+02 HERTZ.								
BUS K	BUS M	RECTANGULAR	NODE VOLTAGE POLAR	RECTANGULAR	BRANCH CURRENT POLAR	POWER FLOW P AND Q	POWER LOSS P AND Q	
83A		.4043509E+06 .5599947E+05	.4082102E+06 7.8849	.3484110E+03 .7434821E+02	.3562553E+03 12.0458	.7252187E+06 -.5275966E+07	.5669779E+06 -.1025542E+09	
	84A	.3779949E+06 .1405543E+05	.3782561E+06 2.1295	-.3993057E+03 .4998589E+03	.6397687E+03 128.6191	-.7195489E+06 -.9727826E+08		
83B		-.1536785E+06 -.3781779E+06	.4082102E+06 -112.1151	-.1098180E+03 -.3389069E+03	.3562553E+03 -107.9542	.7252187E+06 -.5275966E+07	.5669779E+06 -.1025542E+09	
	84B	-.1768251E+06 -.3343809E+06	.3782561E+06 -117.8705	.6325434E+03 .9587942E+02	.6397687E+03 8.6191	-.7195489E+06 -.9727826E+08		
83C		-.2506724E+06	.4082102E+06	-.2385929E+03	.3562553E+03	.7252187E+06	.5669779E+06	

: Etc.

Note that the first branch connects node "B3A" with node "B4A". Using "k" and "m" as abbreviated subscripts for these, the following diagram shows which quantities are printed out for this branch:



In mathematical notation, the following answers will be read from the printout:

$$\begin{aligned}
 V_k &= 404350.9 + j55999.47 = 408210.2 \angle 7.8849^\circ \\
 V_m &= 377994.9 + j14055.43 = 378256.1 \angle 2.1295^\circ \\
 I_{km} &= 348.4110 + j74.34821 = 356.2553 \angle 12.0458^\circ \\
 I_{mk} &= -399.3057 + j499.8589 = 639.7687 \angle 128.6191^\circ \\
 P_{km} + jQ_{km} &= (72.52187 - j5.275966) \cdot 10^6 \\
 P_{mk} + jQ_{mk} &= (-71.95489 - j97.27826) \cdot 10^6 \\
 P_{loss} + jQ_{loss} &= \text{sum of above} = (.5669779 - j102.5542) \cdot 10^6
 \end{aligned}$$

After the last such branch-flow printout, there will be an injection printout for all non-ground nodes which are connected to voltage sources during the steady-state phasor solution. The general format is similar to that which has just been illustrated for branches:

SOLUTION AT NODES WITH KNOWN VOLTAGE. NODES SHORTED TOGETHER BY SWITCHES ARE SHOWN AS A GROUP OF NAMES, WITH THE PRINTED RESULT APPLYING TO THE COMPOSITE GROUP. THE ENTRY 'MVA' IS $\sqrt{P^2 + Q^2}$ IN UNITS OF POWER, WHILE 'P.F.' IS THE ASSOCIATED POWER FACTOR.							
NODE NAME	SOURCE VOLTAGE RECTANGULAR	SOURCE VOLTAGE POLAR	INJECTED SOURCE CURRENT RECTANGULAR	INJECTED SOURCE CURRENT POLAR	INJECTED SOURCE POWER P AND Q	INJECTED SOURCE POWER MVA AND P.F.	
GENA	.1966918E+05 -.7986827E+04	.2122890E+05 -22.1000	.1605429E+05 -.1779876E+05	.2396948E+05 -47.9499	.2289652E+09 .1109321E+09	.2544229E+09 .8999395	1
GENB	-.1675139E+05 -.1304860E+05	.2122890E+05 -142.1000	-.2344132E+05 -.5004043E+04	.2396948E+05 -167.9499	.2289652E+09 .1109321E+09	.2544229E+09 .8999395E+00	
GENC	-.2917797E+04	.2122890E+05	.7387033E+04	.2396948E+05	.2289652E+09	.2544229E+09	

: Etc.

Assuming that we are considering node "k", then the next to the last column gives the injection $P_k + jQ_k$ ----- positive if from the source into the network. The final column shows the magnitude of this complex number, plus the power factor (the cosine of the angle which has tangent Q_k / P_k).

One special feature of the injection printout concerns the effect of closed switches. There will only be one double line of injection printout for each point of known, equal voltage in the network. For example, suppose that three nodes happen to be shorted together by closed switches during the steady-state phasor solution, as per the sketch at the right. Then there would only be one line of injection printout for these three EMTP nodes. All three node names in question would be listed contiguously in the "NODE NAME" column, however, as indication of the node combination or shorting which has occurred:

RBG1
RBG2
RBG

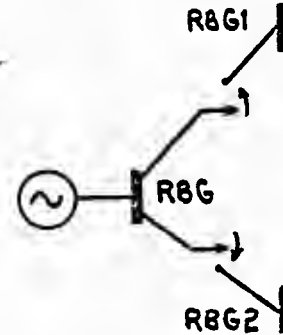

The user should be warned that the aforementioned steady-state phasor branch-flow printout shows an entry for each component in the EMTP branch table (List #2 of Section 0.6), in order. Since the branch table is not sorted (as of 1977), the printout is in the order of data input to the branch table. Nonetheless, there can be confusion in some cases, due to internally-defined nodes and branches. The following comments document the way data can thus be disguised:

- 2) The saturable "TRANSFORMER" of Section 1.25 may contribute a number of entries to the EMTP branch table. See the list of these elements under Message 48 of Section 2.2b . At least in this case all nodes are distinct, and user-defined (so that there is no ambiguity).
- 3) For the Type-16 EMTP source component of Section 1.61, the EMTP internally defines two branches (both resistors) and two nodes ("TYP-16" and "....."). There will be two entries in the steady-state branch-flow printout for each Type-16 component, then.
- 4) Each Type-98 pseudo-nonlinear inductor (Section 1.29) is represented by a linear inductor, for purposes of steady-state solution. The same holds true for each Type-93 (true) nonlinear inductor of Section 1.33 .

- 5) Flashover branches are all open circuits during the steady-state phasor solution. They are not in the branch table (List #2) at all, and have no associated steady-state printout. Included in this category are:
- a) Type-91 time-varying resistance of Section 1.31 ;
 - b) Type-92 (true) nonlinear resistance of Section 1.32 ;
 - c) Type-94 dynamic surge arrester of Section 1.34 .

There also is steady-state (initial condition) printout for dynamic synchronous machine (S.M.) source components (Section 1.62), although the requests for such printout are handled separately as part of the S.M. data. See "Class 5 S.M. Data" of Section 1.62.

Note that such printout is separately controlled for each machine, at present. Anyway, should such printout be requested for one or more machines, the aforementioned injection printout will be followed by the initial condition printout for each machine, of which the following is an illustrative example:

MACH 1A DATA PARAMETERS AND INITIAL CONDITIONS OF NEXT MACHINE FOLLOW. -----
 MACHA User-supplied name for phase "a" of armature connection ----- DUAL, 1ST HALF

MACHINE INDUCTANCE AND RESISTANCE PARAMETERS IN PER UNIT

.185994E+01	LF	=	J-AXIS FIELD SELF INDUCTANCE
.173000E+01	LAF	=	J-AXIS FIELD-ARMATURE MUTUAL INDUCTANCE
.173000E+01	LFKD	=	D-AXIS FIELD-DAMPER MUTUAL INDUCTANCE
.192000E+01	LD	=	D-AXIS ARMATURE SELF INDUCTANCE (SYNCHRONOUS REACTANCE)
.173000E+01	LAKD	=	D-AXIS ARMATURE-DAMPER MUTUAL INDUCTANCE
.189000E+01	LKD	=	D-AXIS DAMPER SELF INDUCTANCE
.220488E+01	LG	=	Q-AXIS CIRCUIT 1 SELF INDUCTANCE
.165000E+01	LAG	=	Q-AXIS CIRCUIT 1-ARMATURE MUTUAL INDUCTANCE
.165000E+01	LG#2	=	Q-AXIS CIRCUIT 1-CIRCUIT 2 MUTUAL INDUCTANCE
.185000E+01	LQ	=	C-AXIS ARMATURE SELF INDUCTANCE
.165000E+01	LAK#2	=	Q-AXIS CIRCUIT 2-ARMATURE MUTUAL INDUCTANCE
.174412E+01	LKQ	=	Q-AXIS CIRCUIT 2-SELF INDUCTANCE
.120000E+00	L0	=	ZERO SEQUENCE REACTANCE
.100000E+00	RH	=	RESISTIVE PART OF NEUTRAL GROUNDING IMPEDANCE
.100000E+00	LN	=	INDUCTIVE PART OF NEUTRAL GROUNDING IMPEDANCE
.108072E+02	RF	=	RESISTANCE OF FIELD WINDING
.172094E+02	RA	=	ARMATURE RESISTANCE
.181540E+01	RKD	=	D-AXIS DAMPER RESISTANCE
.707217E+12	RG	=	Q-AXIS CIRCUIT-1 RESISTANCE
.204599E+01	RKQ	=	Q-AXIS CIRCUIT-2 RESISTANCE

Machine Parameters

Note that this is a "dual" machine bus (2 in parallel)

MECHANICAL PARAMETERS OF MACHINE, IN PER UNIT.

MOMENT OF INERTIA OF ROTOR MASS	SELF-DAMPING COEFFICIENTS OF MASS	MUTUAL-DAMPING COEFF. (WITH FOLLOWING MASS)	TORSIONAL SPRING CONSTANT (WITH FOLLOWING MASS)
.135933E+04	SPEED-DEVIATION	.0	.0
	ABSOLUTE-SPEED	.0	.0

TOTAL CURRENT INJECTED INTO NETWORK AT GENERATOR BUS, IN PHASE COORDINATES. FOR A DUAL-MACHINE BUS, THIS IS THE TOTAL INJECTION (*A* + *B*). THE FIRST LINE DISPLAYS THE CURRENTS AS FOUND BY THE PHASOR NETWORK SOLUTION (WHICH MAY BE UNBALANCED, IF THE NETWORK IS). THE 2ND LINE SHOWS ONLY THE POSITIVE-SEQUENCE COMPONENT, WHICH IS USED FOR MACHINE INITIALIZATION. MAGNITUDES OF THE CURRENTS ARE IN UNITS OF PER UNIT.

	ARMATURE OF PHASE *A*		ARMATURE OF PHASE *B*		ARMATURE OF PHASE *C*	
	MAGNITUDE	DEGREES	MAGNITUDE	DEGREES	MAGNITUDE	DEGREES
ACTUAL	.5235359E+00	182.853900	.1386364E+11	-182.2184307	.1131931E+01	118.4374150
POS. SEQ.	.8316294E+00	21.1893932	.8316294E+00	-98.8106668	.8316294E+00	141.1393932

Note extreme imbalance. One phase of connecting line was open circuited

ARMATURE CURRENTS OF GENERATOR IN ROTATING REFERENCE FRAME (D-Q-0 COORDINATES), IN PER UNIT.

ID	IQ	ID
.1937393E+03	.4703755E+00	.0

ARMATURE CURRENTS OF GENERATOR IN PHASE (REAL AXIS) COORDINATES, IN PER UNIT. POSITIVE-SEQUENCE COMPONENT ONLY, AS USED FOR INITIALIZATION OF THE MACHINE.

ARMATURE OF PHASE *A*		ARMATURE OF PHASE *B*		ARMATURE OF PHASE *C*	
MAGNITUDE	DEGREES	MAGNITUDE	DEGREES	MAGNITUDE	DEGREES
.1333722E+05	21.1893932	.1333722E+05	-98.8106668	.1333722E+05	141.1393932

Note single row of table, since only one mass. No inter-mass torques!

FIELD CURRENT OF GENERATOR, IN PER UNIT.
 .1172413E+01

ELECTRO-MECHANICAL TORQUE OF GENERATOR, IN PER UNIT.
 .3162921E+00

MECHANICAL ANGLES OF ROTOR MASSES, IN UNITS OF (DEGREES) OR (RAD/ANS).
 -.8107134 *THETA* FOR MASS NO. 1 (IN RAD/ANS)

ANGULAR VELOCITIES OF ROTOR MASSES, IN PER UNIT.
 1.3993000 *OMEGA* FOR MASS NO. 1

MACH 1B DATA PARAMETERS AND INITIAL CONDITIONS OF NEXT MACHINE FOLLOW. -----
 MACHA ----- DUAL, 2ND HALF

MACHINE INDUCTANCE AND RESISTANCE PARAMETERS IN PER UNIT

.185994E+01	LF	=	D-AXIS FIELD SELF INDUCTANCE
.173000E+01	LAF	=	D-AXIS FIELD-ARMATURE MUTUAL INDUCTANCE
.173000E+01	LFKD	=	D-AXIS FIELD-DAMPER MUTUAL INDUCTANCE
.192000E+01	LD	=	D-AXIS ARMATURE SELF INDUCTANCE (SYNCHRONOUS REACTANCE)
.173000E+01	LAKD	=	D-AXIS ARMATURE-DAMPER MUTUAL INDUCTANCE
.189000E+01	LKD	=	D-AXIS DAMPER SELF INDUCTANCE
.220488E+01	LG	=	Q-AXIS CIRCUIT 1 SELF INDUCTANCE
.165000E+01	LAG	=	Q-AXIS CIRCUIT 1-ARMATURE MUTUAL INDUCTANCE
.165000E+01	LG#2	=	Q-AXIS CIRCUIT 1-CIRCUIT 2 MUTUAL INDUCTANCE
.185000E+01	LQ	=	C-AXIS ARMATURE SELF INDUCTANCE
.165000E+01	LAK#2	=	Q-AXIS CIRCUIT 2-ARMATURE MUTUAL INDUCTANCE
.174412E+01	LKQ	=	Q-AXIS CIRCUIT 2-SELF INDUCTANCE
.120000E+00	L0	=	ZERO SEQUENCE REACTANCE
.100000E+00	RH	=	RESISTIVE PART OF NEUTRAL GROUNDING IMPEDANCE
.100000E+00	LN	=	INDUCTIVE PART OF NEUTRAL GROUNDING IMPEDANCE
.108072E+02	RF	=	RESISTANCE OF FIELD WINDING
.172094E+02	RA	=	ARMATURE RESISTANCE
.181540E+01	RKD	=	D-AXIS DAMPER RESISTANCE
.707217E+12	RG	=	Q-AXIS CIRCUIT-1 RESISTANCE
.204599E+01	RKQ	=	Q-AXIS CIRCUIT-2 RESISTANCE

Printout for the 2nd half of dual machine follows the 1st

1.1 SPECIALLY-REQUESTED EXTENSIONS TO MISC. DATA CARDS

There are two fields on the integer miscellaneous data card which can require the input of additional data, data which is to immediately follow the integer (2nd) miscellaneous data card, in the following order:

- a) If 'NENERG' of columns 65-72 is nonzero, a special miscellaneous data card must immediately follow the integer miscellaneous data card, for this "STATISTICS" or "SYSTEMATIC" case.
- b) If 'IPUN' of columns 41-48 has value -1, the preceding card (if any) is to be followed by a card which varies the printout frequency.

The format and meaning of these additional cards is as described in the subsections which follow:

1.1a Extra "STATISTICS" or "SYSTEMATIC" Miscellaneous Data Card (Optional)

1 If and only if parameter 'NENERG' of the integer miscellaneous data card has a positive value, the following additional special "STATISTICS" miscellaneous data card is required:

ISW	ITEST	IDIST	AINCR	XMAXNX	DEGMIN	DEGMAX	STATFR	SIGMAX	NSEED
I8	I8	I8	F8.0	F8.0	F8.0	F8.0	F8.0	F8.0	IS

where:

- ISW { 1 --- Request for the printed output of all variable switch closing/opening times, for every energization.
0 --- No printed output of variable switching times will occur.
- ITEST { 0 --- An extra, randomly-selected offset time, calculated using the parameters "DEGMIN", "DEGMAX", and "STATFR", is to be added to the randomly-generated switching times, for each energization.
1 --- No such additional offset is added.
2 --- This extra offset is added to the randomly-generated switch closing times for each energization, but not to the random switch opening times.
3 --- This extra offset is added to the randomly-generated switch opening times for each energization, but not to the random switch closing times.
- IDIST { 0 \Rightarrow All randomly-generated switch closing times (for "STATISTICS" switches) will have Gaussian (normal) distribution.
1 \Rightarrow All randomly-generated switch closing times will have a uniform distribution.
- AINCR ~ The post-solution statistical tabulation of overvoltages, following the solution of all "NENERG" energizations, will use a voltage discretization increment of "AINCR" in per unit. A zero or blank field will be given default value AINCR = 0.05 per unit.

Note : Variable "AINCR" is also used as a flag for the request of additional printout by the EMTP. Add a bias of "55." in order to also produce the familiar base-case printout of minima and maxima (along with their associated times of occurrence) for each energization. This printout is in addition to, and not a replacement for, the regular printout that occurs for each energization.

XMAXMX ~ The maximum per unit overvoltage that the counting algorithm will consider. This is a per unit bound on the tabulated overvoltage distributions which will be outputted, with a default value of 2.0 assumed if the user should input a zero or blank value. A "-" sign on XMAXMX means that the built-in random number generator in the module "SANDMN" is going to be used.

DEGMIN }
DEGMAX } if statistics parameter "ITEST" of columns 9-16 of the
STATFR } same card is zero or blank. In this case, the additional
random time which is to be added to the randomly-generated
switch closing times is produced from these three parameters
for each energization using the following formula:

$$T_{\text{offset}} = \left\{ \frac{1/\text{STATFR}}{360} \right\} \cdot \left\{ (1-\alpha)\text{DEGMIN} + \alpha \cdot \text{DEGMAX} \right\}$$

where α is a random number which is uniformly distributed over the unit interval (0.0, 1.0). "DEGMIN" and "DEGMAX" are thus minimum and maximum angles in degrees which define a "window" of a sine wave having frequency "STATFR" Hz., from which the added time is randomly selected according to a uniform distribution. As an illustrative sample sketch, consider the following example:

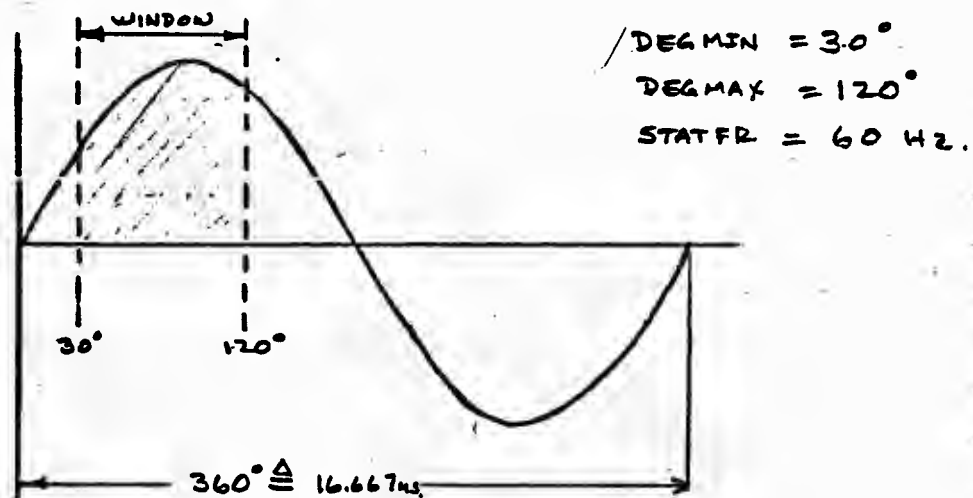

Blank or zero values for fields "DEGMIN" and "DEGMAX" are given default values of zero and 360 degrees, respectively; the corresponding default value for a blank or zero "STATFR" will depend on the particular translation being used, with a value of 60 generally used in North America (where virtually all electric power is of frequency 60 Hz). Default values are set within installation-dependent module "SYSDEP" of overlay number 1.

SIGMAX — For a Gaussian (normal) distribution, "SIGMAX" gives the point at which the "tails" of the distribution will be truncated, for calculating the random switch times. This is as a multiple of the standard deviation, and is symmetric about the mean. A zero or blank field will be given a default value of 4.0, which means that no random switch times further removed than 4σ from the mean will be allowed.

NSEED — Parameter which controls whether or not the random switch times will be identical, should a given "STATISTICS" data case be re-run a second time:

- 1 ⇒ a re-run of the data case will produce identically the same answers; the random-number generating algorithm uses a constant seed of 14 x PI, which does not depend on the time of day.
- 0 ⇒ a re-run of the data case will produce different answers; the seed does depend on the time of day.

The re initialization of the random number generator is done for each energization. However, this can be changed in the system dependent module "RANDNM". Starting with "M39.", VAX, IBM and APOLLO versions initialize the random number generator only once during the 1st energization.

2

If and only if parameter "NENERG" of the integer miscellaneous data card has a negative value, the following additional special "SYSTEMATIC" miscellaneous data card is required:

ISW	ITEST	AINCR	XMAXMX
I8	I8	F8.0	F8.0

ISW — Same meaning as for "STATISTICS" immediately above.

ITEST {

0 ⇒ The inputted switch-time TCLOSE, which is read from a "SYSTEMATIC" switch card, is understood to be the mean switch time. The variation will be around such center values, then.

1 ⇒ The inputted switch-time TCLOSE, which is read from a "SYSTEMATIC" switch card, is understood to be the minimum or beginning switch time. The variation will be for times greater than this, then.

AINCR — Same meaning as for "STATISTICS" immediately above.

XMAXMX — Same meaning as for "STATISTICS" immediately above.

3

If and only if parameter "NENERG" of the integer miscellaneous data card has a positive value, and field "ISW" of the "STATISTICS" miscellaneous data card is punched with the integer 4444, then a special test of the random switch times is produced. In this case, no simulations are actually produced. Rather, the random switch closing times are just generated, and subsequently tabulated statistically, so as to compare the observed distribution with the expected theoretical distribution. For this case where "ISW" is punched with value 4444, two other fields of the "STATISTICS" miscellaneous data card also take on special meaning:

ISW		AINCR		SIGMAX	NSEED
I8		F8.0		F8.0	I8

ISW ----- Punched with special flag 4444, in this case.

AINCR ---- The sample and theoretical cumulative distribution functions will be tabulated at a number of uniformly-spaced time instants. The time-spacing of this tabulation is "AINCR", as a multiple of the standard deviation σ of the switch in question.

SIGMAX --- The range of the just-described tabulated comparison is "SIGMAX" on either side of the mean closing time, as a multiple of the standard deviation σ .

NSEED --- For repeatable results (see previous explanation)

A number of comments might be appropriate, as to usage of this diagnostic feature :

Comment 1 : Characteristic printout of this feature is a series of tabulations for different pairs of switches. Recall that if closing times for switch "A" and switch "B" are both of Gaussian (normal) distribution, then the difference will also be Gaussian and will have mean and standard deviation given by:

$$\bar{T} = \bar{T}_A - \bar{T}_B \quad \sigma = \sqrt{\sigma_A^2 + \sigma_B^2}$$

It is this difference of closing times which is checked, and this is not the same as just looking at the closing times of any one switch. Recall that no random number generating algorithm is truly random; the K+1st number is a function of the K-th number, somehow (usually). Since there is only a finite number of different bit permutations within a computer word, every generating algorithm must eventually repeat. Presumably the period is so large that it is of no practical interest for EMTP usage. But what about correlation of successive numbers? I am still haunted by Stanford's assessment of IBM's random number generator, as reported in the July, 1975 issue of DATAMATION (in the Software and Services section):

"IBM's Scientific Subroutine Package, a collection of over 250 routines, is not getting high marks at Stanford Univ., and will be expelled before the end of the summer. But the real reason SSP is being bounced, says the school, is that many of its routines are inaccurate, obsolete and downright dangerous to use. For example, in RANDU, a uniform random number generator, consecutive triples of numbers are completely correlated. "

Well, for M Gaussian switches, there will be $M(M-1)/2$ such pairings of switches. For each, there will be one tabulated output, of which the following (extracted from a modified version of UTPF Test Case # 77) are typical:

SWITCH PAIR	2	'CSW1	'TO	'C1	'AND	'BSW1	'TO	'A1							
TIME		-3.5000	-3.0000	-2.5000	-2.0000	-1.5000	-1.0000	-0.5000	0.0000	0.5000	1.0000	1.5000	2.0000	2.5000	3.0000
SAMPLE		0.0000	0.0000	0.0000	0.0200	0.0700	0.1500	0.3000	0.4900	0.6700	0.8100	0.9100	0.9500	1.0000	1.0000
THEORETICAL		0.0000	0.0013	0.0062	0.0228	0.0668	0.1587	0.3085	0.5000	0.6915	0.8413	0.9332	0.9772	0.9938	0.9987
TIME		3.5000	4.0000												
SAMPLE		1.0000	1.0000												
THEORETICAL		0.9998	1.0000												

SWITCH PAIR	3	'CSW1	'TO	'C1	'AND	'BSW1	'TO	'A1							
TIME		-3.5000	-3.0000	-2.5000	-2.0000	-1.5000	-1.0000	-0.5000	0.0000	0.5000	1.0000	1.5000	2.0000	2.5000	3.0000
SAMPLE		0.0000	0.0000	0.0000	0.0300	0.0600	0.1800	0.3100	0.4800	0.6200	0.8200	0.9200	0.9400	1.0000	1.0000
THEORETICAL		0.0000	0.0013	0.0062	0.0228	0.0668	0.1587	0.3085	0.5000	0.6915	0.8413	0.9332	0.9772	0.9938	0.9987
TIME		3.5000	4.0000												
SAMPLE		1.0000	1.0000												
THEORETICAL		0.9998	1.0000												

Concerning units, it will be noted that everything has been normalized. The printed "TIME" row gives the number of standard deviations from the mean. The corresponding actual time in seconds could be found from

$$t_k = \bar{T} + \sigma * \text{TIME}(K)$$

Entries in the "TIME" row should normally vary from $-\text{SIGMAX}$ to $+\text{SIGMAX}$; I note that one compartment is missing on the left, since tabulations correspond to the right edge of the compartment.

Comment 2 : The just-described tabulation only applies to Gaussian (normal) switch-closing times. If one or more switches happen to be either deterministic (non-STATISTICS) or uniformly-distributed, they are ignored for purposes of this special tabulation.

Comment 3 : Recall that miniature printer plots of individual switch closing times are outputted at the end of the printout for a conventional "STATISTICS" solution. See Section 1.8b for an example. Well, such plots of switch closing times will also end the run being considered here. All parameters and assumptions related to this output remain unchanged.

Comment 4 : A complete EMTP data case must be used, at least through the blank card which terminates switch cards (see Section 1. for the structure of EMTP data cases). EMTP source cards and all later cards of a conventional case are optional; if so supplied by the user, they will be skipped by the EMTP as it searches for a "BEGIN NEW DATA CASE" record (just as if an EMTP error stop had occurred).

An example of such record skipping can be seen in the sample output of Section 2.4 . The user should remember to always supply such a separator record, even if no other data case follows, in order to avoid reading an end-of-file mark on the input unit "LUNIT5" .

For those knowing something about the EMTP overlay structure, it is worth summarizing where program control is transferred during such a data case. First, data input is quite normal through the blank card which ends EMTP switch cards, as read in "OVER5" . Then there is a jump to "OVER12" for all switch closing time calculation and the printout of Comment 1 ; then there is a jump to "OVER29" for the output as discussed in Comment 3 . Finally, excess cards are discarded in "OVER54" (looking for the "BEGIN NEW DATA CASE" card), before the loop back to "OVER1" to start a new data case.

ELECTROMAGNETIC TRANSIENTS PROGRAM (EMTP), DIGITAL (DEC) VAX-11/780 TRANSLATION AS USED BY SPA IN PORTLAND, OREGON 97208
 DATE (MM/DD/YY) AND TIME OF DAY (HH.MM.SS.)= 04/21/80 12.27.13 ANY PLOTS BEAR SAME FIGURES, VERSION = "M27." .
 IF IN DOUBT AS TO WHAT THE FOLLOWING PRINTOUT MEANS, CONSULT THE 564-PAGE EMTP USER'S MANUAL DATED NOVEMBER, 1977.
 INDEPENDENT LIST LIMITS FOLLOW, TOTAL LENGTH OF /LABEL/ EQUALS 200123 INTEGER WORDS. 703 1050 2500 30 9500
 125 6100 5000 50 300 100 140 5 9000 400 9 4 30 6000 500 72 200 3000 6 3700

 DESCRIPTIVE INTERPRETATION OF NEW-CASE INPUT DATA | INPUT DATA CARD IMAGES PRINTED BELOW, ALL 80 COLUMNS, CHARACTER BY CHARACTER,
 0 1 2 3 4 5 6 7 8
 0 0 0 0 0 0 0 0 0

MARKER CARD PRECEDING NEW DATA CASE. | BEGIN NEW DATA CASE
 MISC. DATA, 0.100E-03 0.200E-01 0.600E+02 | 100.E-6 20.E-3 60.
 MISC. DATA, 10 1 1 1 1 0 0 0100 0 | 10 1 1 100
 STATISTICS DATA, 4444 1 0 0.5000 | 4444 1 0.5 3. 4.0
 SERIES R-L-C, 0.000E+00 0.700E+01 0.000E+00 | 0GENA A1 7.
 SERIES R-L-C, 0.000E+00 0.700E+01 0.000E+00 | 0GENB B1 7.
 SERIES R-L-C, 0.000E+00 0.700E+01 0.000E+00 | 0GENC C1 7.
 SERIES R-L-C, 0.000E+00 0.700E+01 0.000E+00 | 0ENDA A10 7.
 SERIES R-L-C, 0.000E+00 0.700E+01 0.000E+00 | 0ENDB B10 7.
 SERIES R-L-C, 0.000E+00 0.700E+01 0.000E+00 | 0ENDC C10 7.
 0.300E+00 0.211E+01 0.645E+00 0.933E+02 0.301E-02 | 1ASW1 A5 .3 2.1146 0.645 80. 0
 0.266E-01 0.540E+00 0.210E-01 0.261E+03 0.274E-03 | 1BSW1 B5 .0268 .5397 0.021 50. 0
 JRD OR LATER UNIF.-TRANPOSED DISTRIBUTED CONO. | 1-3CSW1 C5
 SERIES R-L-C, 0.100E+01 0.000E+00 0.000E+00 | 1OA5 A5F 1.
 SERIES R-L-C, 0.100E+01 0.000E+00 0.000E+00 | 1OB5 B5F 1.
 SERIES R-L-C, 0.100E+01 0.000E+00 0.000E+00 | 1OC5 C5F 1.
 REFERENCE BRANCH, COPY 'ASW1' TO 'AS' | 1-1A5F ASW10 ASW1 A5
 REFERENCE BRANCH, COPY CONT. | 1-2B5F BSW10
 REFERENCE BRANCH, COPY CONT. | 1-3C5F CSW10
 BLANK CARD TERMINATING BRANCH CARDS.
 SWITCH, 0.20E-02 0.10E-03 0.00E+00 0.00E+00 | 1 A1 ASW1 2.E-3 .1E-3 STATISTICS
 SWITCH, 0.40E-02 0.10E-02 0.00E+00 0.00E+00 | 1 B1 BSW1 4.E-3 1.E-3 STATISTICS
 SWITCH, 0.60E-02 0.10E-02 0.00E+00 0.00E+00 | 1 C1 CSW1 6.E-3 1.E-3 STATISTICS
 SWITCH, 0.80E-02 0.10E+01 0.00E+00 0.00E+00 | 1 A10 ASW10 8.E-3 1.0
 SWITCH, 0.10E-01 0.10E-02 0.00E+00 0.00E+00 | 1 B10 BSW10 10.E-3 1.E-3 STATISTICS
 SWITCH, 0.12E-01 0.10E+01 0.00E+00 0.00E+00 | 1 C10 CSW10 12.E-3 1.0
 BLANK CARD TERMINATING SWITCH CARDS.
 1

SWITCH PAIR	1	'BSW1'	'TO'	'B1'	AND	'ASW1'	'TD'	'A1'				
TIME	-3.5000	-3.0000	-2.5000	-2.0000	-1.5000	-1.0000	-0.5000	0.0000	0	.0000	1.5000	2.5000 3.0000
SAMPLE	0.0000	0.0000	0.0300	0.0300	0.0700	0.1700	0.3100	0.4800		.8300	0.9200	1.0000 1.0000
THEORETICAL	0.0000	0.0013	0.0062	0.0228	0.0668	0.1587	0.3085	0.5000		.8413	0.933	1 0.9938 0.9987

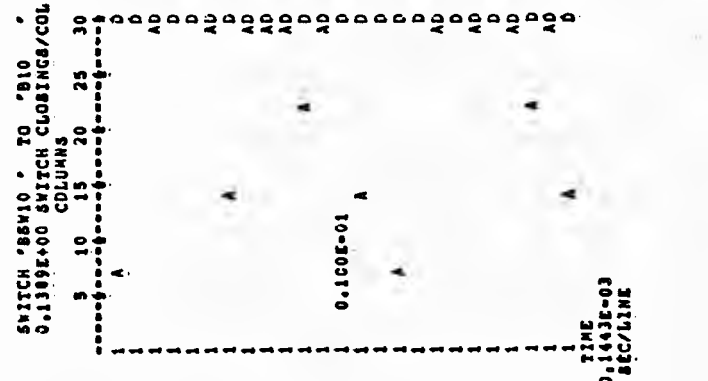
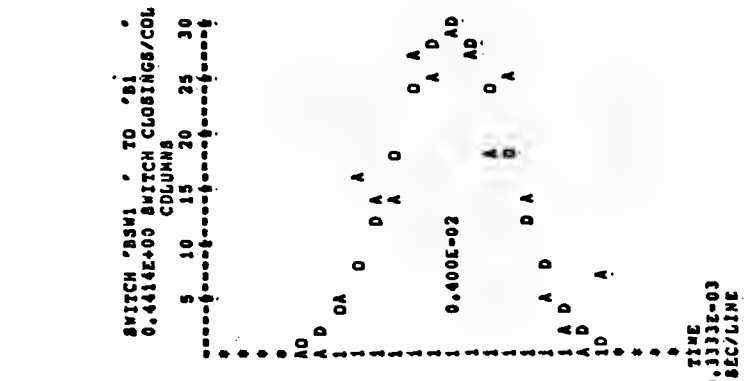

1.1b Card for Varying the Printout Frequency (optional)

If and only if parameter 'IPUN' of the second miscellaneous data card is set by the user to value -1, the following card is to immediately follow the second miscellaneous data card:

				9	10	11	12	13	14	15	16	17	18	19	20	21	22	23	24	25	26	27	28	29	30	31	32	33	34	35	36	37	38	39	40
1 st Change				2 nd Change				Etc.																											
KCHG				MULT				KCHG				MULT				●				●				●											
18				18				18				18																							

This card specifies at what time-step numbers the printout frequency is to be changed, and what values the frequency is to be changed to. Up to five pairs of step numbers and new printout frequencies are permitted, as per the following definitions:

- $KCHG_i$ ----- Time-step number at which the i -th variation in the printout frequency is to begin. Printout for this particular step number is always provided, as a beginning to the new frequency of output.
- $MULT_i$ ----- Modified value of "IOUT" (see second misc. data card), to begin at time-step number $KCHG_i$.

Pairs must be ordered corresponding to increasing time (increasing "KCHG"). No bounding entry is needed, as the last nonzero pair (if less than the full five pairs) simply remains in effect from the time it commences until the end of the study. The first "KCHG" value, read from columns 1-8, must be positive.

Special time-control of diagnostic printout

Minus signs can be appended to the $MULT_i$ values as defined above, if the user wants to control as a function of time the diagnostic printout of the time-step loop. Recall that diagnostic printout will produce output for every time step; if a large number of steps are taken, astronomical quantities of paper will be consumed --- unless such printout is selectively controlled as a function of time. The following scheme is used:

- a) If a minus sign is appended to $MULT(J)$, then at step number $KCHG(J)$ the diagnostic printout status will be changed. That is, there will be a switching of the two sets of diagnostic printout control parameters:
 1. (IPRSOV(K), K=16, 19) of Section 1.0g7 ;
 2. (IPR(K), k=1, 4) of Section 1.0g8 .
 For further explanation, refer to the two sections just cited.
- b) If there is no minus sign, there will be no change in status of the diagnostic printout at the associated time step.

If one or more minus signs are used as just described, it is only the absolute value of $MULT_i$ which controls the production (non-diagnostic) printout frequency as originally described. That is, the use of minus signs does not interfere with the original usage.

1.20 TACS DATA CARDS (IF ANY)

TACS is an acronym derived from the name Transient Analysis of Control Systems. In very general terms, it directly provides the user with modeling capability which is normally associated only with an analog computer, as fully documented in Section 8. . If such modeling is involved in a data case, this present mention is just a reminder that such data is to be physically positioned at this point in the data deck -- before the first EMTF branch card, but after the miscellaneous data cards (and any extensions).

The beginning of TACS data is announced to the EMTF by means of one of the two following special request records:

(A)

1	2	3	4	5	6	7	8	9	10	11	12	13	14	15	16	17	18	19	20	21	22	23	24	25	26	27	28	29	30	31	32	33	34	35	36	37	38	39	40	41	42	43	44	45	46	47	...
TACS STAND ALONE																			IFLAG		(Columns 21-80 available for any additional comments)																										
																			I2																												

This card introduces the TACS data cards describing a system modeled in TACS without any associated electric network components. The data case will look as follows:

```

:
TACS STAND ALONE
  { TACS cards (See Section 8.)
  plotting cards (See Section 1.10)
BEGIN NEW DATA CARDS
:

```

Variable IFLAG of columns 19-20 specifies the ordering the case is solved:

```

IFLAG { 1 -- case is solved according to the user supplied ordering
        0 -- case is solved based on the ordering given on p. 283
       -1 -- case is solved opposite to the ordering user inputted

```

(B)

1	2	3	4	5	6	7	8	9	10	11	12	13	14	15	16	17	18	19	20	21	22	23	24	25	26	27	28	29	30	31	32	33	34	35	36	37	38	39	40	41	42	43	44	45	46	...
TACS HYBRID																			IFLAG		(Columns 21-80 available for any additional comments)																									
																			I2																											

This card introduces the TACS data cards describing a system modeled in TACS and including components interfaced with associated components of the electric network. The data case will look as follows:

```

:
TACS HYBRID
  { TACS cards (See Section 8.)
  {electric network cards (See Section 1.)
:

```

The variable IFLAG has the same meaning as described in (A).

NOTE: The characters 'TACS OUTPUTS' are also recognized as introducing a TACS hybrid case, for convenience to users of older data cases.

1.21 BRANCH CARD FOR UNCOUPLED, LUMPED, SERIES R-L-C BRANCH

To be used for the following types of branches without coupling:

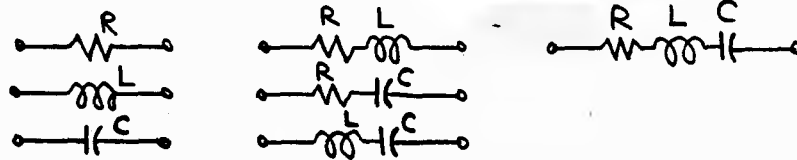
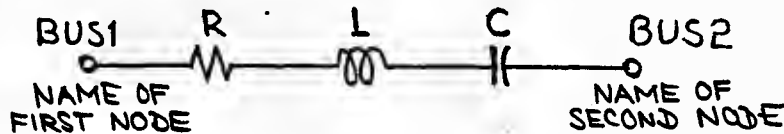
a) RULES

- 1) Punch the branch-type "ITYPE" of columns 1-2 as zero or blank.
- 2) Specify the two terminal nodes of the branch by 6-character alphanumeric node names, using fields "BUS1" and "BUS2" of columns 3-14. One node of the branch may be grounded (field for node name left blank).
- 3) At least one of the values R, L, C of the branch must be $\neq 0$.
- 4) When series branch has no R or L, then set R=0 or L=0. When no capacitance, set C=0 (program regards this as $\frac{1}{\omega C} = 0$).
- 5) If branch data R,L,C are identical with those on a preceding branch card, then the following storage saving option may be used:

Repeat node names of that preceding reference branch in the provided columns 15-26 in the same sequence and leave R,L,C blank.

CAUTION: If the reference branch has other branches in parallel, it is not clear which of them should be the reference branch. Therefore, the first branch among parallel branches with identical node-name pairs shall always be the reference branch. Note that two branches 'NODE-A' to 'NODE-B' and 'NODE-B' to 'NODE-A' do not have identical node-name pairs (order is reversed) and can therefore be used as two distinct reference branches.

- 6) The numerical values for parameters R, L, and C are in the following units. Recall that variables "XOPT" and "COPT" come from the floating-point (first) miscellaneous data card of Section 1.0h .

a) Specify R in ohms.

Maximum resistance to use for voltage sampling

Often the user will have occasion to add a very high resistance branch between two nodes the voltage difference between which he is interested in monitoring. But how high a value is permitted? The general rule is that

R must not exceed the square root of the largest number which the computer system being used can represent in floating-point form. Specifically, one can use a value of 1.E18 ohms on Univac and Honeywell/GE, 1.E35 ohms on IBM, and 1.E100 ohms on CDC. These are convenient round numbers which should always be legal.

Minimum resistance to use for switch isolation or current sampling

The user often has occasion to input one or more very small resistance or inductance branches, for the purpose of either:

- a) the isolation of switches (only one switch may be connected to a node of unknown voltage; see rules of Section 1.4), or
- b) the sampling of current in other branches of the network (not all EMTP components permit current output requests using the familiar column-80 punch).

Ideally, a zero-impedance branch would be used, but this is not possible for the EMTP (an attempt to input a zero-impedance branch will yield an EMTP error message). Instead, the user must employ a "small" impedance value, where the minimum permissible or desirable value is a function of several considerations:

Point 1 : The fundamental limitation is due to floating-point word length of the particular EMTP translation version and computer system which the user is working with. For example,

- a) The user must be very careful when working with a 32-bit REAL*4 translation of IBM (or other similar byte-oriented machine).
- b) Less caution is required for 36-bit translations such as for single-precision Univac or Honeywell/GE.
- c) The user is permitted great latitude on CDC, with its 60-bit word, or when working with a 64-bit REAL*8 translation of IBM.
- d) Finally, of course, a double-precision translation involving 72-bit words as on Univac or Honeywell/GE allows even more recklessness and carelessness!

Point 2 : Singularity tolerances "EPSILN" and "TOLMAT" (floating-point miscellaneous data parameters; see Section 1.0h) are actually used by the EMTP to protect the user against a too-small impedance value. Parameter "EPSILN" is used for the real, all-resistive transient equivalent-network solution, while "TOLMAT" applies to the complex (phasor) admittance-matrix solution for steady-state initial conditions. The general idea is that all impedances which terminate on a given node should not differ drastically in value, as measured by the just-mentioned singularity tolerances. Specific relevant points related hereto include the following:

- a) Considering "EPSILN", the impedances in question are equivalent Norton resistances which result from trapezoidal-rule integration (see Ref. 1). For a resistor, this is just

1.22 BRANCH INPUT USING "CASCADED PI" FEATURE

I. General Philosophical Explanation

The "CASCADED PI" option can be used only for runs which stop after the steady-state phasor solution is complete ($T_{max} \leq 0$, meaning that no transient simulation is to follow). For such studies, numerous Pi-circuits (see Section 1.23) are often cascaded so as to represent a total transmission line, with possible conductor transposition occurring at the points of interconnection of the Pi-circuits; series or shunt elements may sometimes be present at these interconnection points, also. The "CASCADED PI" option can be efficiently used in such cases, provided the user is only interested in the solution at the line terminals. Use of this feature makes it impossible to find out what is going on (i.e., the solution variables) at the internal interconnection nodes and adjacent branches.

The mathematical modeling associated with "CASCADED PI" is worth summarizing, since a general understanding aids efficient usage of this feature. It will later be seen that components representing the line are defined sequentially as a chain, from one end (the sending end) to the other (the receiving end). This data is processed as it is read, sequentially, so as to produce at any stage of the process a mathematical equivalent for all components between the sending end and the last component read. This is shown diagrammatically in Fig. 2.

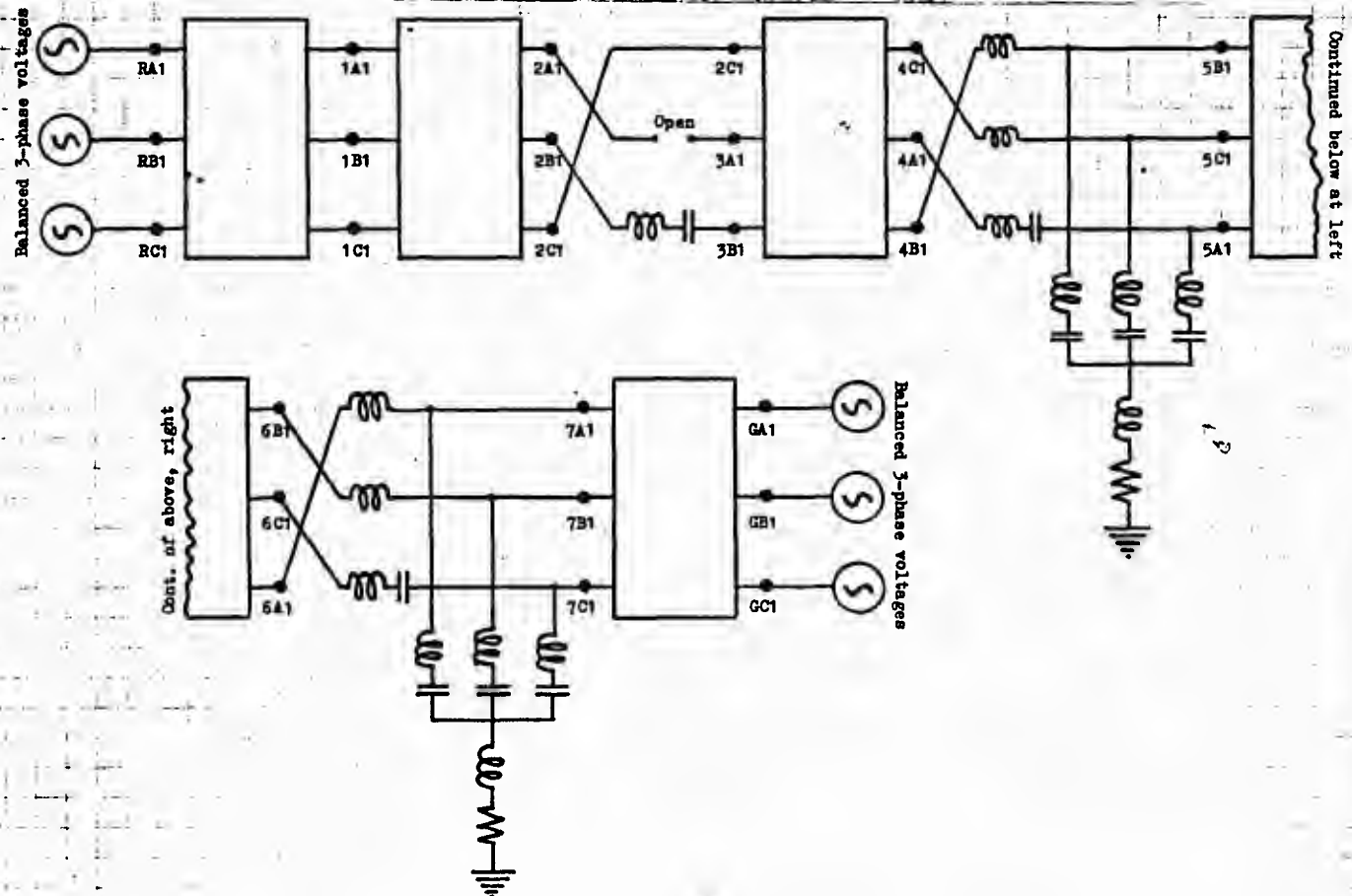

Fig. 1. Sample problem to illustrate usage of the "CASCADED PI" feature. Bus (RA1; RB1; RC1) is the sending end of the line, and bus (GA1; GB1; GC1) is the receiving end.

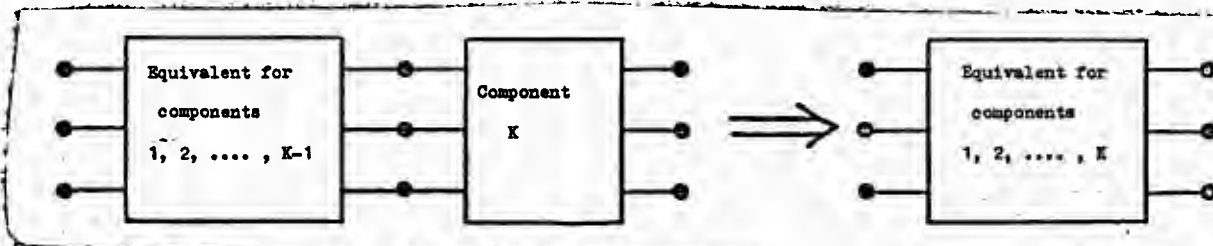

Fig. 2. Schematic illustration of cascading operation for K-th component.

The form of mathematical equivalent used for this is simply the nodal admittance matrix $[Y]$. Hence when input processing of the last component of the chain is complete, an admittance matrix among the terminal nodes of the line exists, as shown at the right. This is an exact mathematical equivalent for all of the interconnected components of the chain, as seen from the terminal nodes. Matrix $[Y]$ is symmetric and complex (i.e., admittance elements $Y_{km} = G_{km} + jB_{km}$).

	Sending	Receiving
Sending	Y_{SS}	Y_{SR}
Receiving	Y_{RS}	Y_{RR}

From the aforementioned description, several points concerning speed and storage requirements associated with this feature may be deduced:

- Point 1: The storage requirement (for $[Y]$) varies as the square of the number of transmission line conductors; it is independent of the number of components which are cascaded together.
- Point 2: Computational effort to produce the equivalent is proportional to the number of components which are cascaded together. The computer time associated with this effort adds to the "data input" time figure of the summary case-termination statistics, not to the time figure for the steady-state solution.

II. Some More-Specific Comments about "CASCADED PI"

Before detailing the specific format of data input for the "CASCADED PI" feature, a few additional comments about restrictions and/or assumptions might be mentioned. Fig. 1 shows a sample problem, the Section-IV setup of which illustrates some of these points:

1. The first line segment of the chain of elements which are to be cascaded may not have any series or shunt connections. That is, the sending end must begin with a Pi-circuit.
2. Second and later sections can each consist of up to four types of sub-components, as follows, in the order shown:
 - a) Series uncoupled R-L-C branches, if any.
 - b) Shunt uncoupled R-L-C branches, if any.
 - c) New line-position (thought of conceptually as transposition) specification, if any.

Class 2 : Specification of bus names, matrices [R], [L], [C]

These data cards are for inputting the sending-end and receiving-end bus names of the line, plus the [R], [L], and [C] matrices which characterize the line geometry of the first section. The format is identical to that which is used for a conventional Pi-circuit:

I T Y P E	Node Names				Reference br.			elements (k,m)			elements (k,m+1)			elements (k,m+2)		
	BUS1	BUS2	BUS3	BUS4	R	L	C	R	L	C	R	L	C			
12	A6	A6	A6	A6	EG.2	EG.2	EG.2	EG.2	EG.2	EG.2	EG.2	EG.2	EG.2			

Rule 1: Number the phases 1, 2, . . . NPHCAS. Make out one branch card plus possible continuation cards, (See Rule 6) for each phase and stack them in this sequence. Indicate this sequence by punching 1, 2, . . . NPHCAS in columns 1-2 of these cards (field ITYPE). These numbers will be referred to later as the line position number for this base matrix.

Rule 2: Specify the circuit consisting of NPHCAS phases by the names of the nodes at both ends (use columns 3-14; field names BUS1, BUS 2). Nodes may be grounded (indicated by blank field name) if desired. These names do not necessarily correspond to the R-L-C matrix values on the same card. The line position card takes care of the relation between bus name and R-L-C matrix values.

Rule 3: At least one of the matrices [R], [L] must be nonzero. Matrix [C] may be zero. Specifically, $[R] + j\omega[L]$ must be non-singular.

Rule 4: If this cascaded pi circuit is identical with another cascaded pi circuit then the following storage-saving option may be used:

Repeat node names of the first branch of that preceding set of branch cards in the provided columns 15-26 of the first branch in the same sequence and leave R, L, C blank. On the 2nd, 3rd, . . . NPHCAS-th branch card only the information in columns 1-14 is used.

CAUTION: 1) Same as in rule 5 of section 1.21.
2) Rule 1 & 2 of this section do not necessarily hold. Rule 1 & 2 of section 1.23 are more pertinent.

NOTE: The program will properly process the reference data with or without the CASCADED PI header card and STOP CASCADE terminator card. Care must be taken that either both or none of these cards should appear.

Rule 5: The numerical values for [R], [L], and [C] are in the following units. Recall that variables XOPT and COPT come from the floating-point miscellaneous data card (see Section 1.0h).

a) Specify R_{ij} in ohms

b) Specify inductances L_{ij} as

1) inductance L in mH if XOPT=0.

Example: If a 5 mile length of line is needed for a section and the R-L-C equivalent pi matrix is per mile then DSECTJ = 5.0. However, if the R-L-C equivalent pi matrix is for a 5 mile length of line, then DSECTJ = 1.0.

Rule 2: If N identical sections are to be cascaded together without any transpositions, then MULTIP can be set to N rather than include N line position cards. There may be series and shunt connections between these sections, but these connections must be the same for all sections handled by this multiplicity feature. Default value of 1 if MULTIP is left blank.

Rule 3: Specification of series connection

MSER=1 This indicates that there is a R-L-C series connection for this section(s) and data for this is to follow.

MSER=0 This indicates that there is no R-L-C series connection for this section(s).

MSER=-1 This indicates that there is a R-L-C series connection for this section(s). The data from the last R-L-C series connection is to be used.

Comment: Should the user desire to put the same R-L-C connection between every other section this can be easily accomplished as follows:

The first section preceded by the R-L-C series connection would have MSER=1. The next section would have MSER=0. The third section, which is to be preceded by a R-L-C series connection would have MSER=-1.

Rule 4: Specification of R-L-C shunt connections MBR=1, 0, -1 has same meaning for shunt R-L-C connections as MSER has for series connections.

Rule 5: Specification of line-section parameters R , L , and C

MSECT= 0 or blank means old R-L-C values are used for following section(s).

MSECT= 1 a new R-L-C matrix is to be read in

Rule 6: Specification of line position. These numbers are a map of the position of the phases of the cascaded circuit. The fields across the card starting in column 25 correspond to the phases in the order their names appear in the BUS1, BUS2 fields on the NPHCAS equivalent pi cards. The number entered in these fields are the row number of the R-L-C equivalent pi matrix. Thus if the conductor connecting the nodes specified by the first equivalent pi card BUS1-BUS2 field has electrical properties which are specified by the third row of the R-L-C matrix then a 3 would be put in column 28.

For 14 or fewer conductors, cols. 25-80 of the data card suffice, as shown. But for 15 or more conductors, the MAPCAS(I) data spills over onto as many extra cards of the format 24X, 14I4 as are required to complete the data input.

Class 6 : Shunt R-L-C branch specification

Series R-L-C branches may be connected in shunt, thereby being categorized as shunt R-L-C branches of data class number 6. This is illustrated by the Fig. 1 schematic diagram, at busses 7A1, 7B1, and 7C1. The shunt branches in question can be connected between any two nodes which are either conductor nodes or intermediate extra nodes, including local ground. The applicable format and rules for such shunt R-L-C branches are as follows:

Terminal node numbers		Branch parameter values		
N1	N2	R	L	C
IG	IG	E6.2	E6.2	E6.2

Rule 1: Fields N1 and N2 are to be punched with node numbers. If one wants a conductor, the associated node number is the positive integer (row or column number) assigned to it in the line-parameter matrices R, L, and C. Zero or blank is reserved for local ground. Any other new, intermediate nodes are given consecutive negative integer values -1, -2, etc. for as many as are needed. Such numbering is local to the line section in question, with one beginning over again with -1 the next time. A limit of "NPHCAS" such intermediate nodes for each section exists (i.e., not more than one for each conductor).

Rule 2: At least one of the parameter values R, L, or C of each branch must be nonzero.

Rule 3: If the desired branch has no resistance, set R equal to zero (or leave blank); if the branch has no inductance, set L equal to zero (or leave blank); if the branch has no capacitance, set C equal to zero (or leave blank), which is interpreted by the EMTP as though series capacitance C were actually infinite, a capacitive short circuit.

Rule 4: The numerical values for R, L, and C are in the following units. Recall that variables XOPT and COPT come from the floating-point miscellaneous data card (see Section 1.0h).

- a) Specify R_{ij} in ohms
- b) Specify inductances L_{ij} as
 - i) inductance L in mH if $XOPT=0$.
 - ii) reactance ωL in ohms at frequency $\frac{\omega}{2\pi} = XOPT$ if $XOPT \neq 0$.
- c) Specify capacitances C_{ij} as
 - i) capacitance C in μF if $COPT=0$.
 - ii) susceptance ωC in μ mhos at frequency $\frac{\omega}{2\pi} = COPT$ if $COPT \neq 0$.

Rule 5: The end of such shunt R-L-C branch cards is signaled by a blank card.

Class 7 : Change of line parameters [R], [L], and [C]

During the cascading process, the line geometry can be altered if desired, which necessitates the redefinition of matrices [R], [L], and [C]. If this is the case, field "MSECT" of the associated line-position card (Class 4 data) must have been punched with value "1". The general data format for Class 7 input then is like that of Class 2, with the following exceptions:

- a) Rules 2 and 4 of the Class 2 data description do not apply. There are no bus names "BUS1" and "BUS2" to be inputted, so leave columns 3-14 blank. No storage-saving option is possible, so likewise enter nothing in cols. 15-26.

Class 8 : Termination of Cascaded-PI data

The last card in the definition sequence for a line which is being modeled using "CASCADED PI" is a record reading "STOP CASCADE", as per the following format:

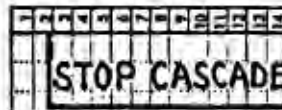

This card tells the EMTP that it has now processed all sections making up the line which connects the sending-end and receiving-end busses which were defined on the Class 2 data input.

IV. Illustrative Sample Usage of "CASCADED PI" Feature

Fig. 1 displays a sample network for which the steady-state sinusoidal phasor solution can be found in two different ways: first, using the conventional, manual EMTP data setup, and second using the "CASCADED PI" modeling capability just described. Listings of these two alternative data case setups for this problem are shown below:

```

BEGIN NEW DATA CASE
C   UTPF TEST CASE NO. 19
C   CHECK CASE FOR THE SAMPLE SMALL STEADY-STATE PROBLEM WHICH
C   ILLUSTRATES MANY FEATURES OF THE 'CASCADED PI' CAPABILITY OF THE T.P.
C   THIS CASE IS COMPLETELY SET UP MANUALLY, WITHOUT ANY USE OF THE
C   'CASCADED PI' OPTION. THE ANSWERS SHOULD BE IDENTICAL, OF COURSE.
    0      0      60.
      1      1
1RA1  1A1      .877  8.40 .1628
2RB1  1B1      .747  4.14-.0252  .852  8.43 .1559
3RC1  1C1      .735  3.47-.0067  .723  4.17-.0277  .829  8.46 .1571
11A1  2A1  RA1  1A1
21B1  2B1
31C1  2C1
02B1  3B1      13.1449.071
12C1  4C1  RA1  1A1
23A1  4A1
33B1  4B1
04C1  5C1      13.14
04A1  5A1      13.1449.071
04B1  5B1  4C1  5C1
05C1  5G1  2B1  3B1
05A1  5G1  2B1  3B1
05B1  5G1  2B1  3B1
      5.0 13.14
15B1  6B1  RA1  1A1
25C1  6C1
35A1  6A1
    6A1  7A1  4B1  5B1
    6B1  7B1  4C1  5C1
    
```



1.23 BRANCH CARDS FOR PI-EQUIVALENTS

This class of branches provides for the representation of lumped-element resistance, inductance, and capacitance matrices. For N conductors, the associated differential equations are:

$$\vec{V}_k - \vec{V}_m = [L] \frac{d\vec{I}_{km}}{dt} + [R] \vec{I}_{km}$$

$$\vec{I}_k = \frac{1}{2} [C] \frac{d\vec{V}_k}{dt} + \vec{I}_{km}$$

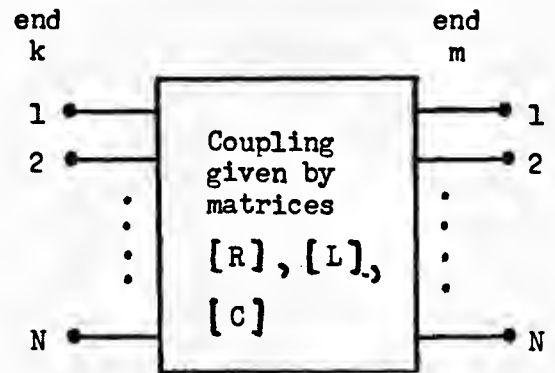
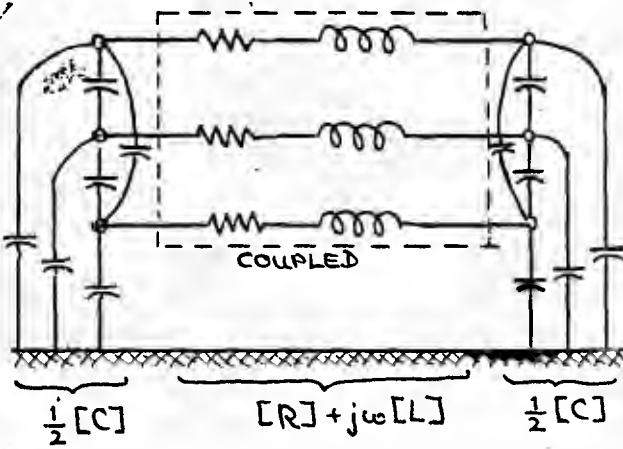
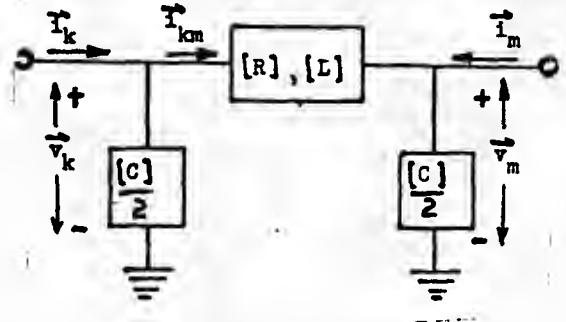
$$\vec{I}_m = \frac{1}{2} [C] \frac{d\vec{V}_m}{dt} - \vec{I}_{km}$$



All matrices are assumed to be symmetric, and it will be noted that $[C]$ is split in two, with half of the total on each end of the branch.

Principal use of this model at BPA is to represent short, untransposed sections of transmission line, for which the perfect-transposition assumption of distributed-parameter representation (Section 1.26) is not acceptable. By connecting many such short sections in series, keeping track of actual transpositions (if any), a model for a long line can be made. For such use, the matrices $[R]$, $[L]$, and $[C]$ can be automatically calculated by the BPA line constants program.⁵ Yet because of increased running time and core-storage requirements, this modelling should generally be used only as a last resort, where distributed-parameter lines are believed to be inadequate. Refer to further discussion in Section 3.3.

While $[C] = [0]$ (no capacitance) is a legal input option, this special situation represents only mutually-coupled R-L branches, for which the separate input format of Section 1.24 has been provided.

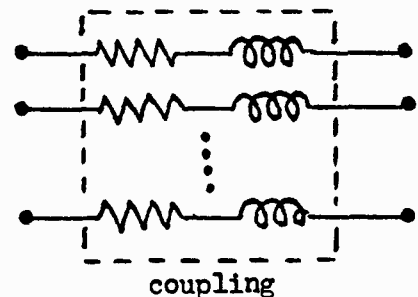

If the user wants just a multiphase ($N \geq 2$) capacitance matrix to ground, then he can input a near-infinite-impedance series branch, and ground all conductors at the far end. In particular, set

$$R_{ii} = 10^{\gamma} \quad \text{for all } i$$

$$R_{ij} = 0 \quad \text{for } i \neq j$$

$$[L] = [0]$$

$[C]$ = twice the desired final matrix, since it will be halved, remember.

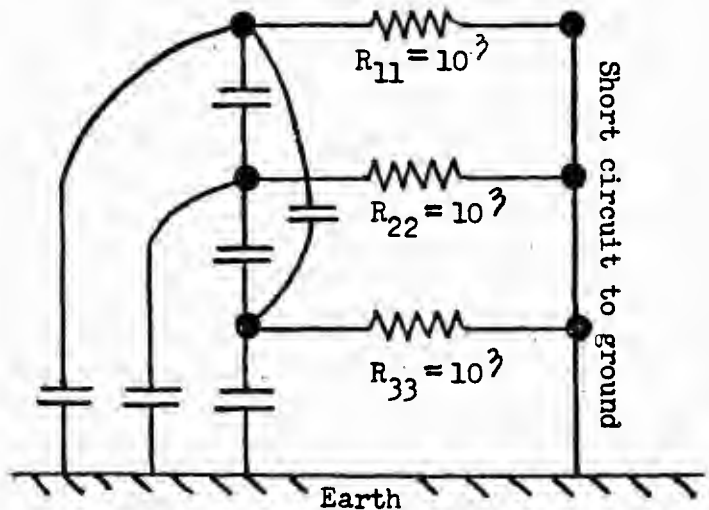

Here γ is a "large" exponent, ideally infinite; in practice it is limited by the computer installation being used. Refer to discussion of high-impedance branches, Section 1.21 .

Elements of the matrices $[R]$, $[L]$, and $[C]$ have the following meaning in the sinusoidal steady state at frequency ω :

diagonal $R_{ii} + j\omega L_{ii}$ = self impedance of branch i (impedance of loop "branch i --ground return"); off-diagonal $R_{ik} + j\omega L_{ik}$ = mutual impedance between branches i and k . ($R_{ik} \neq 0$ with nonzero ground resistivity)

diagonal C_{ii} = sum of all capacitances connected to the nodes at both ends of branch i ; off-diagonal C_{ik} = negative value of capacitance from branch i to branch k .

Data format for data cards

To specify an N-conductor Pi-equivalent, the following rules and format are to be observed:

ITYPE	Node Names				elements (k,m)			elements (k,m+1)			elements (k,m+2)		
	BUS1	BUS2	BUS3	BUS4	R	L	C	R	L	C	R	L	C
12	A6	A6	A6	A6	EG.2	EG.2	EG.2	EG.2	EG.2	EG.2	EG.2	EG.2	EG.2

Rule 1: Number the phases 1, 2, ..., N. Make out one branch card (plus possible continuation cards; see Rule 6) for each phase, and stack them in this sequence. Indicate this sequence by punching 1, 2, ..., N in columns 1-2 of these cards (field ITYPE). Limits on N are $1 \ll N \ll 40$.

Rule 2: Specify each of the phases 1, 2, ..., N by the names of the nodes at both ends (use columns 3-14; field names BUS1, BUS2). Nodes may be grounded (indicated by blank field name) if desired.

Rule 3: At least one of the matrices $[R]$, $[L]$ must be nonzero. Matrix $[C]$ may be zero, though then the Section 1.24 input can be used.

Rule 4: If branch data are identical with those on a preceding set of N branch cards, then the following storage-saving option may be used:

Repeat node names of the first branch of that preceding set of branch cards in the provided columns 15-26 of the first branch in the same sequence and leave R,L,C blank. On the 2nd, 3rd, ..., N-th branch card only the information in columns 1-14 is used.

CAUTION: Same as in rule 5 of section 1.21.

Rule 5: The numerical values for $[R]$, $[L]$, and $[C]$ are in the following units. Recall that variables XOPT and COPT come from the floating-point miscellaneous data card of Section 1.0h .

a) Specify R_{ij} in ohms

b) Specify inductances L_{ij} as

i) inductance L in mH if XOPT=0.

ii) reactance ωL in ohms at frequency $\frac{\omega}{2\pi} = \text{XOPT}$ if XOPT $\neq 0$.

c) Specify capacitances C_{ij} as

i) capacitance C in μF if COPT=0 .

ii) susceptance ωC in μmhos at frequency $\frac{\omega}{2\pi} = \text{COPT}$ if COPT $\neq 0$.

Rule 6: Matrices $[R]$, $[L]$, and $[C]$ are symmetric, so only need be specified on and below the diagonal. The following format applies:

1	Node names of 1st branch		R_{11}	L_{11}	C_{11}								
2	Node names of 2nd branch		R_{21}	L_{21}	C_{21}	R_{22}	L_{22}	C_{22}					
3	Node names of 3rd branch		R_{31}	L_{31}	C_{31}	R_{32}	L_{32}	C_{32}	R_{33}	L_{33}	C_{33}		
4	Node names of 4th branch		R_{41}	L_{41}	C_{41}	R_{42}	L_{42}	C_{42}	R_{43}	L_{43}	C_{43}		
			R_{44}	L_{44}	C_{44}								
5	Node names of 5th branch		R_{51}	L_{51}	C_{51}	R_{52}	L_{52}	C_{52}	R_{53}	L_{53}	C_{53}		
			R_{54}	L_{54}	C_{54}	R_{55}	L_{55}	C_{55}					

⋮ etc.

When one card is not sufficient for all required R-L-C values (for the fourth and later phases), then "continuation cards" are used, with columns 1-26 left blank, it will be noted.

Rule 7: No branch current output is possible for this branch type. However, the branch voltage can be obtained on the first two phases (where column 80 of the card is not being used) by punching a "2" in column 80.

Alternative performance equation for series segment of Pi-circuit

Instead of describing the series leg of a multi-conductor ($N \geq 2$) Pi-circuit by means of matrices [R] and [L], the user may prefer to use arrays [A] and [B], defined by the alternative performance equation

$$\frac{d\vec{I}_{km}}{dt} = [A] \cdot (\vec{V}_k - \vec{V}_m) + [B] \vec{I}_{km}$$

If this be the case, he then can use the following procedure:

Rule 8: Immediately preceding all mutually coupled branches (note plural; $N \geq 2$) for which the AB-option is desired, insert an extra data card with the code "USE AB" punched in what is normally the BUS1-field

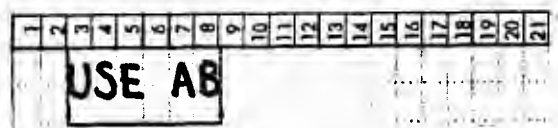

Rule 9: For all multi-conductor coupled circuits in question, punch the elements of [A] where those of [R] would normally appear, and those of [B] instead of [L]:

$$[R] \xrightarrow{\text{becomes}} [A] \qquad [L] \xrightarrow{\text{becomes}} [B]$$

Rule 10: To return to the use of [R] and [L] after having used [A] and [B], insert an extra data card with the code "USE RL" punched in what is normally the BUS1-field. For all data following this card, then, use of the R-L formulation is assumed ---- until another "USE AB" card should be encountered.

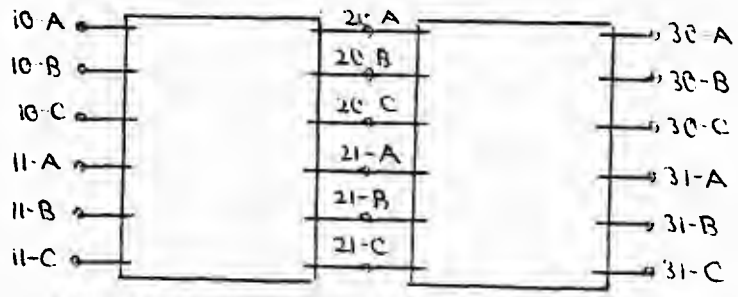
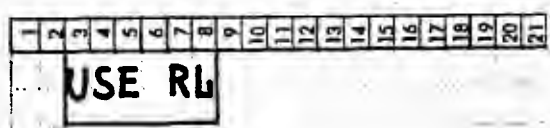

Example

Consider the modelling of two 3-phase circuits on the same right of way, so that they are mutually coupled. Together these two circuits constitute six coupled conductors ($N=6$). With two identical Pi-equivalents cascaded, the data cards appear as follows:

1.24 Branch Cards for Mutually-Coupled R-L Elements

This class of branches provides for the representation of lumped-element, mutually-coupled R-L branches. Associated with these branches are matrices [L] and [R] having performance equations

$$\vec{V}_k - \vec{V}_m = [L] \frac{d\vec{I}_{km}}{dt} + [R] \vec{I}_{km}$$

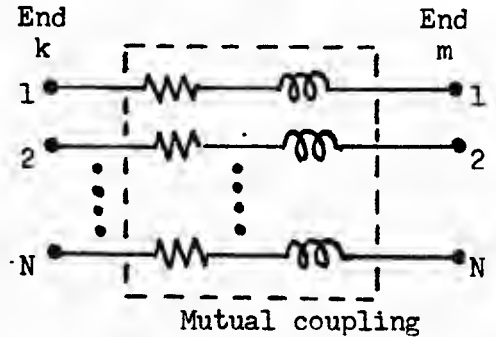
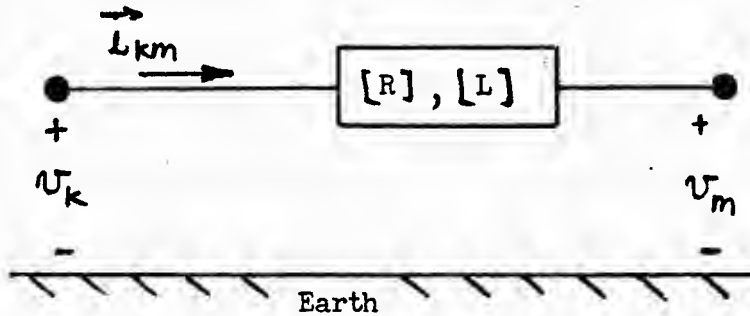

Matrices [R] and [L] are assumed to be symmetric.

Note that this branch type is identical in performance to the Pi-equivalent of Section 1.23, if the user therein sets the capacitance matrix [C] to zero. But in the present section the inductance data fields (see below) have 12 columns rather than just 6, allowing for greater precision. This option is intended to be used primarily for coupled impedances representing transformers, wherein it is necessary to have highly-accurate values for self and mutual impedances; otherwise the leakage impedances get lost in the magnetizing impedance. See Section 6. for a discussion of transformer representation.

Data format for data cards

To specify N mutually-coupled R-L elements, the following rules and format are to be observed:

ITYPE	Node Names				Reference br. elements (k,m)		elements (k,m+1)		elements (k,m+2)	
	BUS1	BUS2	BUS3	BUS4	R	L	R	L	R	L
12	A6	A6	A6	A6	E6.2	E12.2	E6.2	E12.2	E6.2	E12.2

Rule 1: Number the phases 51, 52, ..., (50+N). Make out one branch card (plus possible continuation cards; see Rule 5) for each phase, and stack them in this sequence. Indicate this sequence by punching 51, 52, ..., (50+N) in columns 1-2 of these cards (field ITYPE). Limits on N are $1 \leq N \leq 40$.

Rule 2: Specify each of the phases 51, 52, ..., (50+N) by the names of the nodes at both ends (use columns 3-14; field names BUS1 and BUS2). Nodes may be grounded (indicated by blank field name) if desired.

Rule 3: If branch data are identical with those on a preceding set of N branch cards, then the following storage-saving option may be used:

Repeat the node names of the first branch of that preceding set of branch cards in columns 15-26 (fields BUS3 and BUS4) of the first branch in the same sequence of this new group, and leave R and L fields blank. On the 2nd, 3rd, ..., N-th branch card, only the information in columns 1-14 (ITYPE, BUS1, BUS2) is used.

CAUTION: As the reference branch is only identified by an ordered pair of node names, ambiguity is possible. If more than one candidate fulfills this description (of 2 or more parallel branches), then the program simply chooses the first such branch inputted. Note that two branches 'NODE-A' to 'NODE-B' and 'NODE-B' to 'NODE-A' do not have the same node-name pairs (since the order is reversed), and can therefore be used as two distinct reference branches.

Rule 4: The numerical values for [R] and [L] are in the following units. Recall that variables XOPT and COPT come from the floating-point miscellaneous data card (see Section 1.0h) .

- a) Specify R_{ij} in ohms
- b) Specify inductances L_{ij} as
 - i) inductance L in mH if $XOPT = 0$.
 - ii) reactance ωL in ohms at frequency $\frac{\omega}{2\pi} = XOPT$ if $XOPT \neq 0$.

Rule 5: Matrices [R] and [L] are symmetric, so only need be specified on and below the diagonal. The following format applies:

51	Node names of 1st branch		R_{11}	L_{11}					
52	Node names of 2nd branch		R_{21}	L_{21}	R_{22}	L_{22}			
53	Node names of 3rd branch		R_{31}	L_{31}	R_{32}	L_{32}	R_{33}	L_{33}	
54	Node names of 4th branch		R_{41}	L_{41}	R_{42}	L_{42}	R_{43}	L_{43}	
			R_{44}	L_{44}					
55	Node names of 5th branch		R_{51}	L_{51}	R_{52}	L_{52}	R_{53}	L_{53}	
			R_{54}	L_{54}	R_{55}	L_{55}			

∴ Etc.

When one card is not sufficient for all required R-L values (for the fourth and later elements), then "continuation" cards are used, with columns 1-26 left blank, it will be noted.

Rule 6: No branch current output is possible for this branch type. However, the branch voltage can be obtained on the first two phases (where column 80 of the card is not being used) by punching a "2" in column 80.

Optional use of Z_0 and Z_1 for 3-phase coupled R-L branches

Suppose that the user has exactly three coupled R-L branches, with the associated $[R]$ and $[L]$ matrices having common diagonal values Z_s and common off-diagonal values Z_m , as shown in the sketch. Then rather than inputting $[R]$ and $[L]$, it may be more convenient to input the associated zero and positive-sequence values, (R_0, L_0) and (R_1, L_1) , respectively.

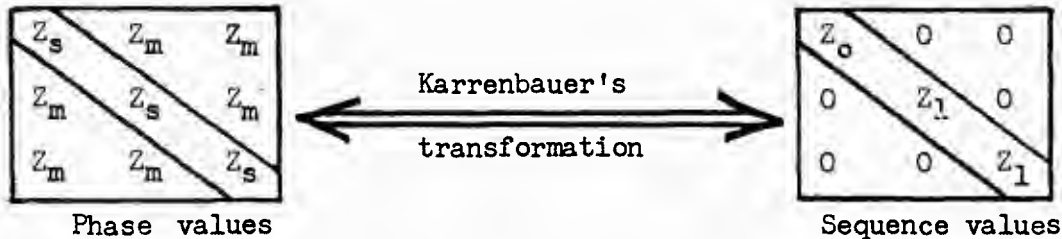

Section 4.1 details the transformation formulas of Karrenbauer which are assumed to apply, and the preceding format specification is modified slightly, giving the following:

1	2	3	4	5	6	7	8	9	10	11	12	13	14	15	16	17	18	19	20	21	22	23	24	25	26	27	28	29	30	31	32	33	34	35	36	37	38	39	40	41	42	43	44
ITYPE		Node Names												Sequence Values																													
		BUS1						BUS2						R					L																								
I2		A6						A6						E6.2					E12.2																								

Rule A: Number the 3 phases 51, 52, and 53. Make out a branch card for each, in this sequence. Indicate this sequence by punching 51, 52, and 53 in columns 1-2 of these cards (field ITYPE).

Rule B: Specify the phases by means of the names of the nodes at both ends (use columns 3-14; field names BUS1 and BUS2). Nodes may be grounded (indicated by blank field name) if desired.

Rule C: Resistance and inductance values are punched in columns 27-44 (fields R and L). Zero sequence values R_0, L_0 go on the first (phase 51) card, while positive-sequence values R_1, L_1 go on the second card; columns 15-80 of the third card are to be left blank. Units for R are ohms, while L is in mH unless XOPT \neq 0 (in which case L is in ohms at frequency XOPT; see Rule 4).

Rule D: Once a 3-phase branch has been so inputted, it can be used as a reference branch for identical 3-phase branches to follow. See Rule 3 above.

WARNING! If columns 15-80 of that third branch card are not left blank, the EMTP will not recognize the coupled branches as being specified with sequence values. In that case, the phase-domain format will be assumed, with the result being one very unbalanced, erroneous representation. Something as innocent as an illegal column-80 punch for branch current will cause big trouble (ask Al Legate; 7 April 1980).

1.25 Saturable Transformer Components

Single-phase transformer

The single-phase N-winding transformer shall be considered first. It is a building block for the 3-phase 3-leg core-type unit to be considered later.

Actually, the use of saturation is not mandatory. If the flux-current magnetization characteristic consists of a single finite-slope segment, then all-linear components are used in the model, and numerically the resulting solution will be identical (except for roundoff differences) to that of Section 1.24 where matrices $[R]$ and $[L]$ are used. Thus even in the linear case, the present section may be used; it may be found to be more convenient and more general than Section 1.24 .

The saturable N-winding single-phase transformer in question is modelled as per the figure below. Pertinent points include the following:

1. N-1 single-phase, 2-winding ideal transformers are involved, providing the correct transformation ratios of windings 2, 3, ... , N with respect to winding 1 .
2. Each winding k has an associated leakage-impedance branch, characterized by resistance R_k and inductance L_k . All leakage inductances with the exception of L_1 must be nonzero.
3. Saturation and magnetizing-current effects are confined to a single nonlinear reactor in the winding-1 circuit. This is internally modelled as a type-98 pseudo-nonlinear reactor, should the saturation characteristic have two or more segments; for a single segment, a simple, constant linear inductance element is used ---- in which case the transformer is completely linear.
4. Core losses are confined to the constant, linear resistance R_{mag} which is in parallel with the saturation branch.

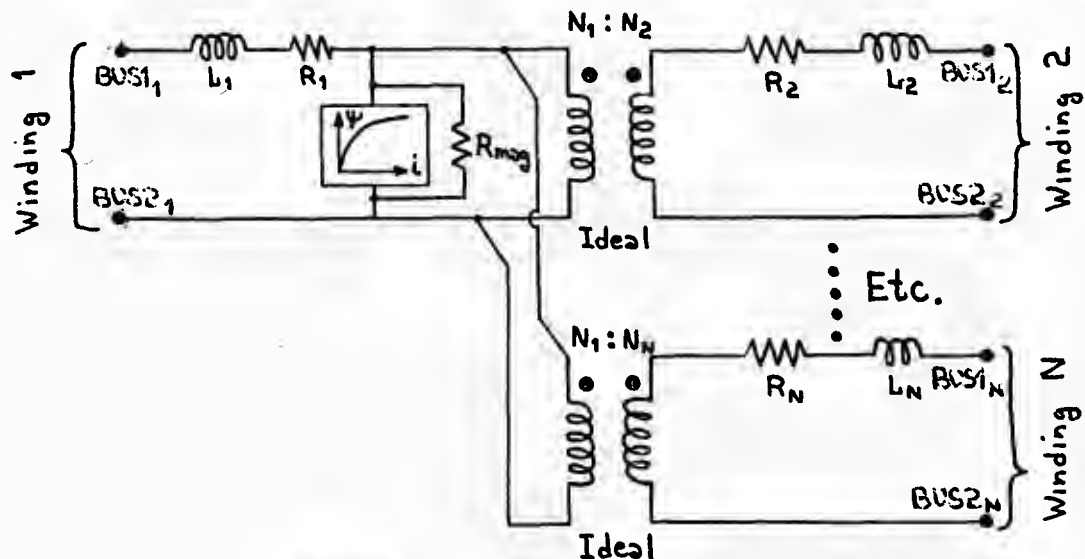

Equivalent circuit used to represent saturable, N-winding, single-phase transformer.

b) Current and flux pairs for the breakpoints are punched in fields CUR and FLUX. These use columns 1-32, one pair of values per card, inputted in monotone-increasing order (movement away from the origin). Both coordinates must be strictly monotone increasing.

CUR	FLUX
E16.0	E16.0

c) The final point on the characteristic merely defines the slope of the final segment, which is assumed to extend to infinity. The last point is followed by a terminating card with "9999" punched in columns 13-16.

9999

Normally the first point of the characteristic will equal $(i_{steady}, \psi_{steady})$, in order to provide continuity between steady-state and transient solutions at time zero, though this is not mandatory. Note that if only one $i-\psi$ point is inputted, a linear transformer results; with no $i-\psi$ data points preceding the 9999-card, the magnetizing reactance is assumed not to exist.

Rule 3: For each transformer winding k ($k=1, 2, \dots, N$), the user inputs a winding card in the following format:

1	2	3	4	5	6	7	8	9	10	11	12	13	14	15	16	17	18	19	20	21	22	23	24	25	26	27	28	29	30	31	32	33	34	35	36	37	38	39	40	41	42	43	44		80
ITYPE	Node names													Leakage Z				Volts				IOUT																							
	BUS1						BUS2							R_k		L_k		(N_k)		•••																									
	A6						A6							E6.2		E6.2		E6.2																											

Identifying node names for the current output will be "BUS1" of the primary terminals, and internal node "BUSTOP"

- ITYPE ----- Winding number (1, 2,). Cards must be placed in natural order, with winding 1 first, then winding 2, etc.
- BUS1 } ----- Six-character node names of the busses to which the
BUS2 } winding in question is connected. As usual, a blank field is taken to mean ground.
- R_k } ----- Leakage values associated with the winding in question.
 L_k } R_k is resistance in ohms, while L_k is inductance in mH (unless XOPT parameter of 1st misc. data card is nonzero, in which case L_k is in ohms at frequency XOPT Hz).
 R_k may be zero, but L_k must be nonzero (with the exception of winding 1, where $L_1 = 0$ is permitted if $R_1 \neq 0$).
- Volts ----- A number proportional to the number of turns of the winding in question. It is convenient simply to use the rated winding voltage in kV.
- IOUT ----- Only for winding 1 (the primary), a 1-punch in column 80 will make branch current i_1 an output variable.

Rule 4: Should the user desire to specify a transformer having parameters identical to those of a previously-inputted unit, he can use the following reference-component procedure:

- a) On the card of rule 1, punch only the fields shown at the right. Field BUS3 now carries the name which was punched as variable BUSTOP (cols. 39-44)

Special request word	Ref. name	BUSTOP
2AG	AG	AG

for the reference component of which a copy is desired.

- b) Omit the cards of Rule 2 (the $i-\psi$ curve).

	Node names	
11	EUS1	EUS2
12	AG	AG

- c) For the cards of Rule 3 (the winding cards), punch only the fields shown at the right.

The user is encouraged to use this option whenever possible, as it saves storage space in certain program tables, and avoids possible numerical error in the data associated with the components which are copied.

Three-Phase Transformer

In a 3-phase shell-type transformer, an iron-core path is provided for the return of zero-sequence flux. For this case, it is reasonable to model the device with 3 separate single-phase units, thereby assuming that the magnetic induction of the three phases is independent. In this way, a 3-phase shell-type transformer presents no complication.

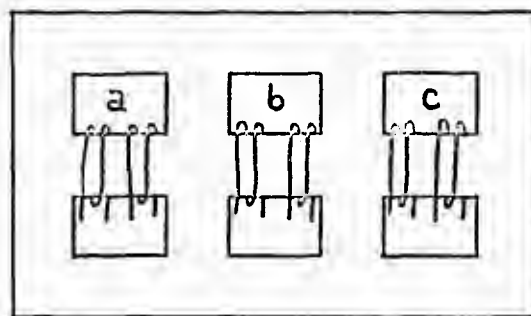

3-phase shell-type transformer

But for the 3-phase, 3-leg, core-type transformer, zero sequence flux is forced to return through the air. As the resulting performance is radically different (in general; for situations where the zero-sequence is excited) than that of three single-phase units, a new 3-phase component is clearly called for. Such a component now exists in the T.P., conforming to the following assumptions:

Assumption a)

A magnetization characteristic $i-\psi$ is known for each of the three legs of the transformer. For any one leg (any phase), this characteristic relates the flux in the leg to the MMF difference between the two ends of the leg (top and bottom in the sketch). Note that this is not the experimentally-measured curve obtained from one winding of one phase, with all others open-circuited.

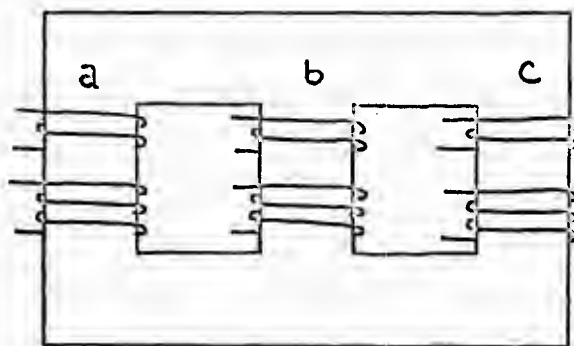

3-phase, 3-leg, core-type transformer

Assumption b)

The air-return path for zero-sequence flux is assumed to have known, constant magnetic reluctance \mathcal{R}_0 .
 By definition, zero-sequence flux travels between the top and bottom members of the unit, through the air.

With this physical data available, a 3-phase core-type transformer can be modelled as in the figure at the right. Note that this is an interconnection of three saturable single-phase transformers, two ideal isolation transformers, and a zero-sequence inductance L_0 . Data input for this model is according to the following rules:

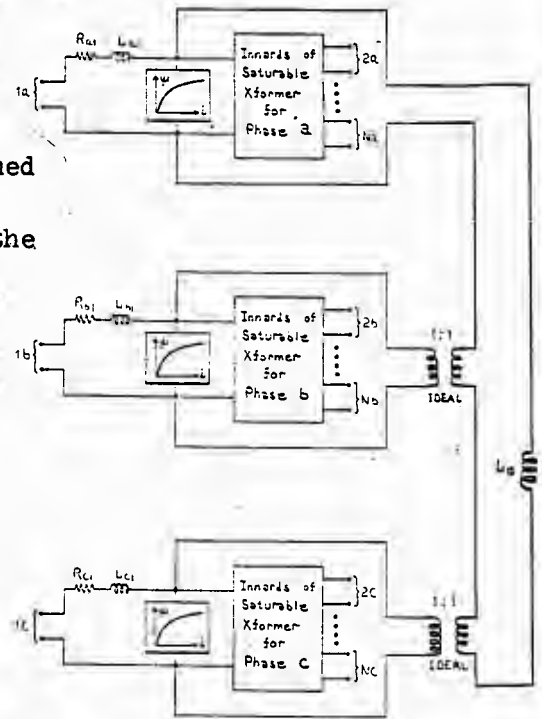

Rule 5: Begin with a request card for the 3-phase transformer component, using the following format:

1	2	3	4	5	6	7	8	9	10	11	12	13	14	15	16	17	18	19	20	21	22	23	24	25	26	27	28	29	30	31	32	33	34	35	36	37	38																								
		Special Request Word																																																											
		TRANSFORMER THREE PHASE																																																											

The field marked "Special Request Word" (columns 3-26) is to be punched with the 24 characters "TRANSFORMER THREE PHASE".

BUS3PH ----- A 6-character alphanumeric name associated with the transformer. This should be distinct from all other names used in the study.

\mathcal{R}_0 ----- Reluctance of the zero-sequence air-return path for flux. In the circuit, $L_0 = N_1^2 / \mathcal{R}_0$.
 Units used should be consistent with current and voltage used elsewhere; the units for "time" are always seconds.

Rule 6: The preceding request card is to be followed by data cards for three saturable, single-phase transformer components. These single-phase transformers have parameters which would exist if a perfect magnetic short circuit (i.e., a magnetic connection with a member having infinite permeability) were placed between the top and the bottom ends of the cores. The reference-component procedure (Rule 4) can be used for any and/or all of the single-phase units in question. In order of input, this transformer data defines the 3 saturable single-phase units of the above equivalent circuit. As the 2 ideal transformers and their associated interconnection is handled automatically by the program, this completes the data input for the 3-phase, 3-leg, core-type unit.

Delta transformer connections

Delta transformer connections can sometimes be a little tricky. They also are not uncommon, so that a little specific explanation of this configuration is perhaps in order.

First, there is the equivalent circuit when modeled using three single-phase saturable transformer components. If it is the primary which is delta connected, and if the secondary is grounded-Wye, then the following sketch shows the resulting interconnection of elementary components:

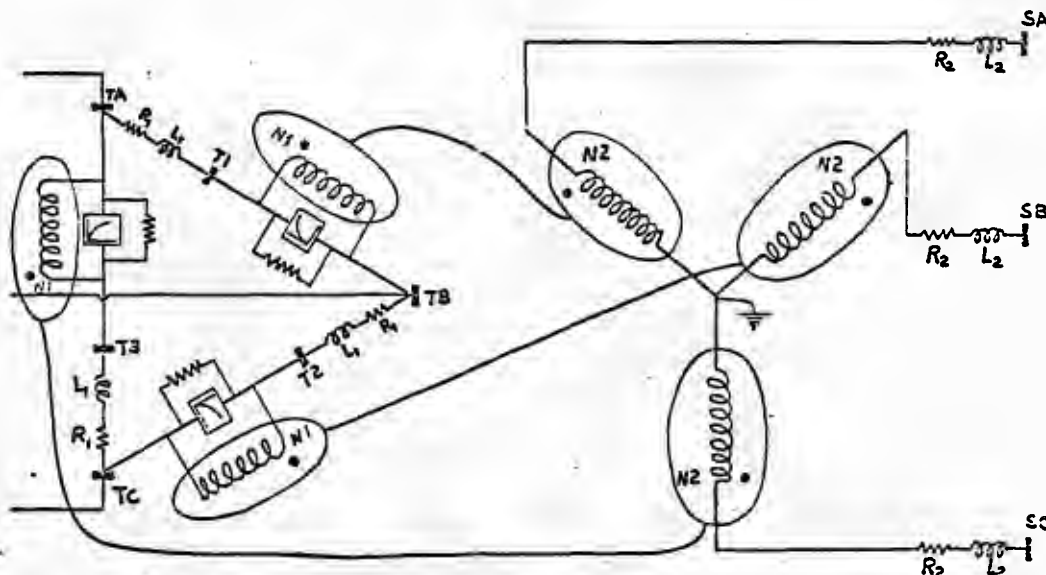

Here R_1 and L_1 are the primary leakage-impedance parameters (assumed to be the same for all three transformers), and R_2 and L_2 are those for the secondary. Bus "T1" is the internal node "BUSSTOP" for the first single-phase transformer whose primary terminals are "TA" and "TB", and whose secondary terminals are "SA" and ground. Et cetera for the other two single-phase transformers, as per the following EMTP data-setup listing (for details, see Ref. 8, November 12, 1975):

TRANSFORMER		2.0	1137. T1	3.00E5
2.	1137.			
50.	1365.			
10000.	1478.6			
	9999			
ITA	TB	.25	25.	3.03E5
2SA		.25	25.	3.03E5
TRANSFORMER T1			T2	
1TB	TC			
2S3				
TRANSFORMER T1			T3	
1TC	TA			
2S6				

A second principal point concerns the need for a path to ground on the delta side of the bank; a floating delta is not allowed, since mathematically the voltages there would then only be defined within an arbitrary constant. Of course if a transmission line is connected to the delta side, there is no problem, since line capacitance provides the connection to ground. Likewise

a connection to one or more voltage sources, either direct or through other "simple" elements, will satisfy the requirement. But the common, isolated, delta-connected tertiary of 3-winding transformers requires special attention. There are two common, general approaches:

Unbalanced solution : If the user is interested not at all in voltages on the delta side, it is convenient to simply ground one corner of the delta (see sketch). This provides the needed ground connection without altering the problem solution elsewhere (since no current can flow in the connection to ground anyway, by Kirchhoff's current law).

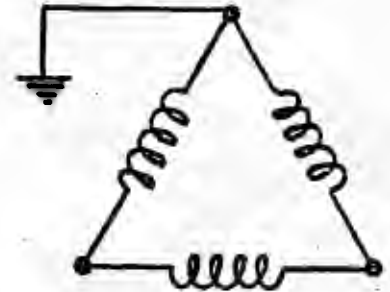

Balanced solution : If preserving the inherent balance on the delta side is important, then stray capacitance can be added. The simplest procedure is to connect three equal capacitors from the corners of the delta to ground, as in the sketch at the right. Caution must be exercised to use realistic values, however; as such capacitors go to zero, a matrix singularity will be approached, and the user will get into trouble with miscellaneous data parameter singularity tolerances "EPSILN" and "TOLMAT" (see Section 1.0h explanation). The EMTP memorandum of November 12, 1975 (Ref. 8), Fig. 2 shows a value of $0.003 \mu\text{F}$ being used on each corner of the delta connection of a 25-kV delta to 500-kV Wye transformer bank.

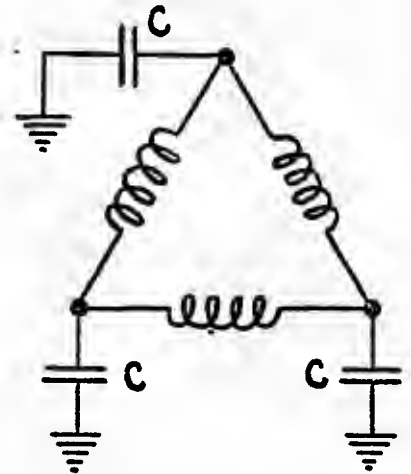

Warning About Possible 3-Winding Numerical Instability

A warning about possible numerical instability must be given, with respect to the three-winding saturable "TRANSFORMER" component. As of August 1977, three different groups of EMTP users have observed the problem:

1. Dick Webster of Pacific Gas & Electric in San Francisco, California;
2. Alan Courts of BPA, Portland, Oregon;
3. An associate of Dr. Brian Dixon of B.C. Hydro, Vancouver, B.C.

The obvious symptom of trouble with such numerical instability will be a string of Message-18 printout ("TROUBLE AT 73912 ON TYPE-99 OR 98 ELEM NUMBER") as described in Section 2.2b . This assumes that the magnetization characteristic is truly nonlinear (two or more sections), so will be internally represented by a Type-98 pseudo-nonlinear inductance element.

The Message 18 printout is somewhat deceptive, in that there really is no trouble with the Type-98 element at all. If one looks at network node voltages, he will see in such cases that the solution is diverging; it is blowing up exponentially. Program Maintenance at BPA looked at Dick Webster's problem in some detail. The transient simulation was really just a continuation of the 60 Hz steady state phasor solution; and for two or three cycles, the graphs appeared to the eye to be perfectly sinusoidal. There was no abrupt discontinuity or shock at any point. Rather, it appeared simply that roundoff error (numerical noise) was being amplified as the simulation progressed; one could not detect exactly when the "hash" began, but it appeared to grow exponentially with time. Physically, the performance was what an engineer might expect had there been negative damping in the system. Dick's case, which still looked nice and sinusoidal at 50 msec, was blown off the machine with exponent overflow by about 100 msec, as I recall.

So what is the reason for such erroneous behavior? It is not believed to be an EMTP bug (programming error). Hermann (Prof. Dommel) has some ideas, but we are not prepared to formally state anything at this time. The user should be aware of the potential for trouble in the 3-winding case, however. Yet he is not necessarily advised to avoid all 3-winding saturable "TRANSFORMER" usage, since most situations seem to pose no trouble. An example of trouble-free usage will be found in the GPU Stolle Road problem of UTPF Test Case #17.

The "XFORMER" supporting routine of Section 7.1 does provide an alternative to the use of the saturable "TRANSFORMER" component. The resulting transformer representation will be linear, however. Also, not over three windings are allowed at present. Here the approach is to generate [R] and [L] matrices, to be used as per Section 1.24 .

1.26 Branch Cards for Distributed-Parameter Transmission Lines

General Comments

The modelling used to represent transmission lines in the Transients Program poses a number of possibilities for the user.

To start the analysis, one can write the "exact" partial differential equations governing the voltage and current on the line. For N phases (conductors), these are

$$-\frac{\partial \vec{v}}{\partial x} = [L] \frac{\partial \vec{i}}{\partial t} + [R] \vec{i}$$

$$-\frac{\partial \vec{i}}{\partial x} = [C] \frac{\partial \vec{v}}{\partial t} + [G] \vec{v}$$

Although the incremental section of line has been sketched only for N=1, in general these are vector-matrix equations, where [L], [R], and [C] can be determined from a line-constants program. See "LINE CONSTANTS" of Sect. 7.4.

Now if the transmission line is assumed to be transposed (or just-balanced, if 2-phase), then all matrices have only two distinct element values: all diagonals have a common value "S", and all off-diagonals have a common value "M".

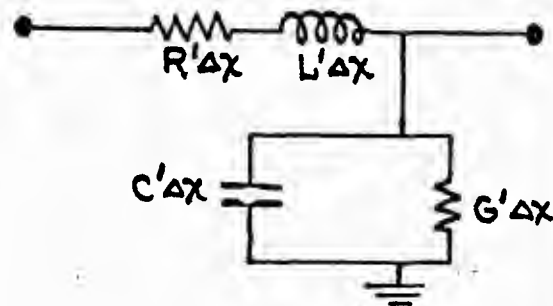

Incremental section, length = Δx

"S" ⇒ Self
 "M" ⇒ Mutual

S	M	M
M	S	M
M	M	S

But if such a transposition assumption is not realistic for the study contemplated, two options are now available. For a long time, the only option was to cascade lumped-parameter Pi-sections, each of which approximately represents the actual construction over the maybe 20 or so miles of the sections. Yet such a lumped-parameter solution is costly in computer time and storage requirements, so should be avoided if practical.

In December, 1980, the option of modeling the line as untransposed was implemented in the EMTP with the help of Dr. K.C. Lee of the University of British Columbia in Vancouver, B.C., who originally developed this modeling capability (see Reference 30).

Untransposed lines

For an untransposed transmission line, the self impedances (capacitances) of all phases as well as their mutual impedances (capacitances) are no longer equal among themselves. However, the line constants matrices are still symmetric. Modal decoupling is still possible, but the transformation matrices required for the diagonalization process are now characteristic of the line configuration, and must be supplied by the user. The diagonal matrices [Z'(mode)] and [C'(mode)] in the modal domain are obtained from



13 a

$$[Z'(\text{mode})] = [Tv]^{-1} [Z'(\text{phase})] [Ti]$$

$$[C'(\text{mode})] = [Ti]^{-1} [C'(\text{phase})] [Tv]$$

where $[Ti]^{-1} = [Tv]^t$,

with the columns of $[Tv]$ being the eigenvectors of the matrix product $[Z'(\text{phase})] [j\omega C(\text{phase})]$. Voltages and currents in phase quantities are obtained from modal quantities with $[Ti]$ and $[Tv]$ as follows:

and $[i(\text{phase})] = [Ti] [i(\text{mode})]$,

$$[v(\text{phase})] = [Tv] [v(\text{mode})]$$

Input data for untransposed transmission lines must be given in modal quantities, i.e., N sets of values $R'(\text{mode})$, $L'(\text{mode})$ and $C'(\text{mode})$ must be specified on the N cards of an N-phase line. These N cards are followed by cards for the modal transformation matrix $[Ti]$. This modal transformation matrix $[Ti]$ for the currents as well as the branch cards for the untransposed line are now automatically generated on unit LUNIT7 when one runs "LINE CONSTANTS" of the EMTF.

Theoretically, the transformation matrix $[Ti]$ is complex as well as frequency-dependent. For overhead lines, however, it was found that the matrix $[Ti]$ can be approximated by a frequency-independent matrix over a frequency range from 10 Hz to 10 kHz with sufficient accuracy.

An example of branch cards and transformation matrix generated on LUNIT7 is shown below. This is the result of running "LINE CONSTANTS" of an untransposed John Day to Lower Monumental line of 138. miles long.

I								N
T								P
Y								H
P	NODE NAMES	R	Zs	v	DIST			A
E								S
								E
\$VINTAGE, 1								
-1JDA	LMA	0.48410E+00	0.59859E+03	0.13567E+06	-0.13800E+03	1	3	
-2JDB	LMB	0.28246E-01	0.29090E+03	0.18277E+06	-0.13800E+03	1	3	
-3JDC	LMC	0.31914E-01	0.27530E+03	0.18181E+06	-0.13800E+03	1	3	
\$VINTAGE, 0								
	0.58603393	0.70710678	-0.40391419	} -----	real part of row 1 of [Ti]			
	0.02421025	0.00000000	0.02143232		imag. part of row 1 of [Ti]			
	0.55636368	0.00000000	0.81998412		.			
	-0.04914911	0.00000000	0.02034723		.			
	0.58603393	-0.70710678	-0.40391419		etc.			
	0.02421025	0.00000000	0.02143232	.				

where R is the modal resistance, Z_s is the modal surge impedance, v is the modal speed of propagation, and DIST is the length of the line (with extra minus sign appended). A few key points should be noted here:

1) The branch data on LUNIT7 are generated with the higher-precision format as shown on p. 15a-1.

2) The two 6-character bus names of each branch (columns 3 - 14) are automatically generated by the program when one runs "LINE CONSTANTS" with "BRANCH" option.

3) The negative sign on the length of the line is a flag for EMTF to recognize it is an untransposed line when this format is used.

4) Complex-valued transformation matrix $[Ti]$ elements use 6E12.5 format.

5) The user also has the option of inputting these branch cards with the regular format described on p.14 and p.15.

Transposed lines

The original modeling of the continuously transposed distributed parameter line can now be viewed as a special case of the untransposed line modeling, where the former has only two distinct matrix elements. The N mutually-coupled variables in the phase domain can again be converted to N equivalent uncoupled modes by the aforementioned transformation matrices $[Tv]$ and $[Ti]$. However, for a transposed line, there are only two distinct modes -- a zero-sequence (ground) mode and $(N-1)$ identical positive-sequence (line) modes.

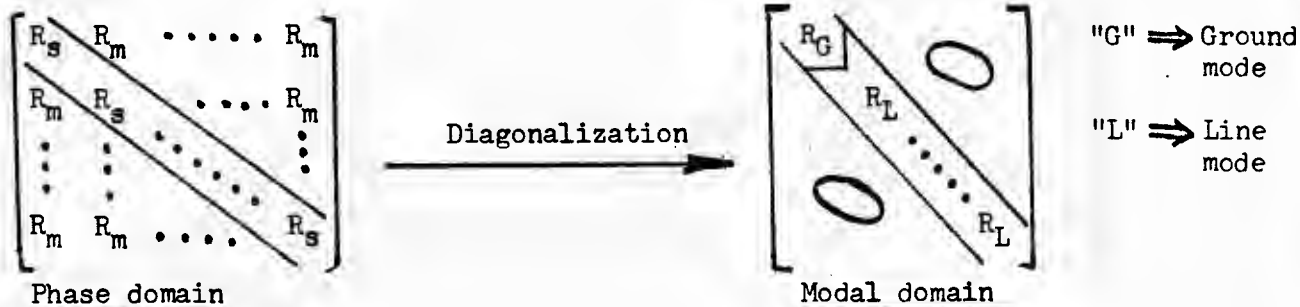

Similar relations apply to $[L]$ and $[C]$.

Until now, the Karrenbauer's transformation was used in the EMTF to diagonalize the matrices for a transposed line. However, one key characteristic of the Karrenbauer transformation, $[Tv] = [Ti]$, is not generally valid for an untransposed line. Rather than have two different sets of logic for the conversion of variables between phase and modal domains, it was decided to treat the transposed line as just a particular special case of the untransposed one. In both bases, the conversion formula given on the last page is used. To accomplish this, a more general transformation matrix has now been chosen to replace the originally used Karrenbauer transformation. This new transformation matrix $[Ti]$ was first used in the EMTF by Ontario Hydro, in the "SEMLYEN SETUP" code of Section 7.5. It has the following form:

$$[T_i] = \begin{bmatrix}
 \frac{1}{\sqrt{N}} & \frac{1}{\sqrt{2}} & \frac{1}{\sqrt{6}} & \dots & \frac{1}{\sqrt{J(J-1)}} & \dots & \frac{1}{\sqrt{N(N-1)}} \\
 \frac{1}{\sqrt{N}} & -\frac{1}{\sqrt{2}} & \frac{1}{\sqrt{6}} & \dots & \frac{1}{\sqrt{J(J-1)}} & \dots & \frac{1}{\sqrt{N(N-1)}} \\
 \frac{1}{\sqrt{N}} & 0 & -\frac{2}{\sqrt{6}} & \dots & \vdots & \dots & \vdots \\
 \vdots & \vdots & 0 & \dots & \vdots & \dots & \vdots \\
 \vdots & \vdots & \vdots & \dots & -\frac{(J-1)}{\sqrt{J(J-1)}} & \dots & \vdots \\
 \vdots & \vdots & \vdots & \dots & 0 & \dots & \vdots \\
 \frac{1}{\sqrt{N}} & 0 & 0 & \dots & 0 & \dots & -\frac{(N-1)}{\sqrt{N(N-1)}}
 \end{bmatrix}$$

J-th col. ↓

J-th row →

where N is the number of phases of the line.

When $N=1$, $[T_i]=1$. This corresponds to a single-phase transmission line which is mathematically identical with its zero sequence (i.e., transformation produces no change), this special case simply has no positive sequence values; only zero sequence data is inputted.

Such a transformation matrix $[T_i]$ is generated by the EMTF right after each continuously-transposed line is inputted. From then on, there is no difference in the EMTF in treatment of untransposed and transposed lines, as far as the conversion logic between phase and modal domains is concerned. Removal of the Karrenbauer transformation and its associated logic resulted in a reduction of about 350 lines of EMTF FORTRAN. This, however, does not change the original input format for the transposed line, nor does it change the results of physical variables (i.e., phase voltages and currents should be identical).

Distortionless line modelling

A transmission-line mode is well known⁶ to be distortionless if parameters for that mode satisfy the relation $R/L = G/C$. Of course actual leakage conductance for an overhead line is very nearly zero, and no provision for inputting a nonzero value is provided by this program anyway. If the user wants distortionless-line modelling, it is presumed that the input value of R' is meant to be a measure of the total line losses. Therefore the program splits the losses into series and shunt losses by computing the series resistance R'_{series} and the leakage conductance G'_{leak} from the relation

$$\frac{R'_{\text{series}}}{L'} = \frac{G'_{\text{leak}}}{C'} = 0.5 \left(\frac{R'}{L'} \right)$$

With this formula, the ac steady-state results are practically identical whether the line is modelled as distortionless or in the other two ways to follow. Transient responses differ mainly in the initial rise of voltage pulses. The attenuation constant α is found from the relation

$$\alpha = \frac{1}{2} \cdot \frac{R'}{L'} \cdot \sqrt{L'C'} = \frac{1}{2} \frac{R'}{Z}, \text{ with } Z = \sqrt{\frac{L'}{C'}}$$

The corresponding decrement factor is $e^{-\alpha \ell}$ where ℓ is the line length. Such distortionless modelling is generally used only for the positive sequence, if at all.

Lumped-resistance line modelling

The second (and only other) distributed model which is readily solvable is that in which the series resistance is pulled outside of the distributed line, and represented as a lumped element. This is the most common representation used in BPA studies, the standard representation which is assumed unless the user specifically requests otherwise (see variable IPUNCH, cols. 53-54). The program automatically cuts the line in two, inserting half of the resistance in the middle, and one fourth at each end:

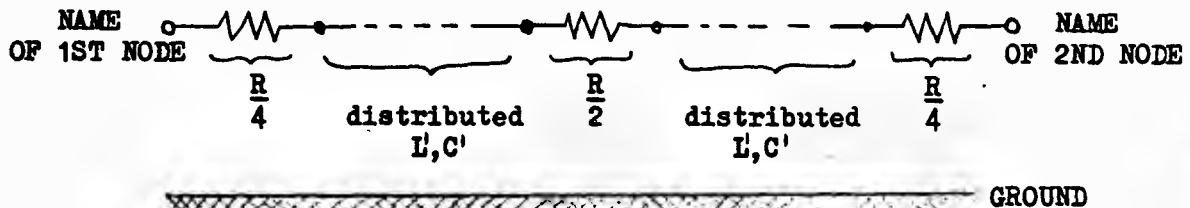

The half-length distributed sections then become lossless (hence distortionless, with attenuation $\alpha = 0$). Both modes of most lines in BPA studies are usually so represented at present. See further comments in Section 4.2.

Frequency-dependent modelling

The resistance and inductance of the zero-sequence mode are typically quite variable with frequency; the resistance in particular, which is furthermore substantially larger than for the positive-sequence mode. Several frequency dependent representations are now available, as described in Sections 1.26b and 1.27 .

Data format for distributed-parameter line cards

To specify an N-conductor, distributed-parameter transmission line, conform to the following rules and format:

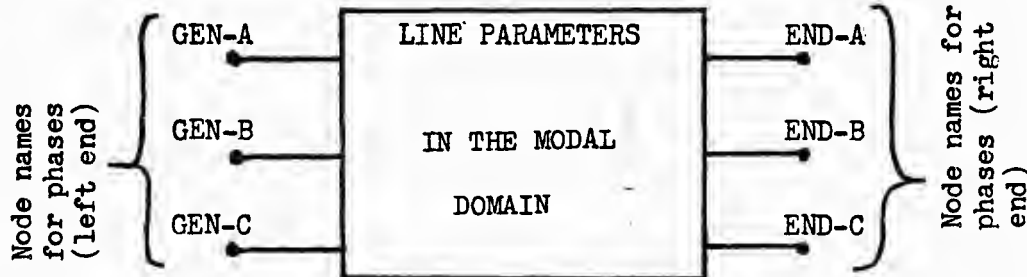

- Rule 1:** Number the phases -1, -2, -3, ..., -N . Make out one branch card for each phase, and stack them in this sequence. Indicate this sequence by punching -1, -N in columns 1-2 of these cards (field ITYPE). N cannot exceed 9 phases.
- Rule 2:** Specify each of the phases -1, , -N by the names of the nodes at both ends (columns 3-14; field names BUS1, BUS2). Nodes may be grounded (indicated by blank name field) if desired.
- Rule 3:** If the parameters for this line are identical to those of another N-phase line previously inputted, then the option of rule 4 in section 1.23 may be used, except that no storage is saved here. Columns 15-26 with field names BUS3 and BUS4 are used in this case. Otherwise, they are left blank.
- Rule 4:** For an N-phase continuously-transposed line, there exists only two modes. Specify the zero-sequence parameters on the first card (the card for the first phase), and the positive-sequence parameters on the second card (the card for the second phase). Leave the modal parameters blank on the third and later branch cards. For an N-phase untransposed line, there exists N different modes. Specify the modal parameters for the first mode on the first card, and those for the second mode on the second card, etc. for the the third and later modes. The four basic pieces of modal information needed are resistance, inductance, capacitance, and length; yet three forms for this input are possible:
- In all cases, punch resistance R' in ohms per unit length in columns 27-32, and line length l in consistent units in columns 45-50.
 - Parameter ILINE (columns 51-52) determines how L' and C' may be disguised. Remember that variables XOPT and COPT come from the floating-point (first) miscellaneous data card of Section 1.0h .

15 a

Rule 9: IPOSE = $\begin{cases} 0 & \text{or blank: Line is assumed to be transposed.} \\ N & \text{: Number of phases of an untransposed line.} \end{cases}$

Rule 10: Only when IPOSE is nonzero, the transformation matrix [Ti] is read immediately after the N-th branch card. The elements of the matrix [Ti] are read in by rows (row 1 first, then row 2, etc.). For a given row, the real part of matrix element for all columns come first; then the imaginary part follows on a new card. Within each row, elements are read in order of increasing column number. Each row begins with a new card, and there are 6 or fewer elements per card. The following format is applicable to row 'k' of a 6-phase line.

TI _{k,1}	TI _{k,2}	TI _{k,3}	TI _{k,4}	TI _{k,5}	TI _{k,6}
E12.5	E12.5	E12.5	E12.5	E12.5	E12.5

If the transmission line had only 3 phases, the final three fields (columns 37-72) would not be used. For $N < 6$ phases, exactly $2N$ data cards are involved; for $7 \leq N \leq 12$ phases, exactly $4N$ data cards are involved, etc. Note that there must be exactly $2N^2$ elements for [Ti].

1.26a SPECIAL DOUBLE-CIRCUIT DISTRIBUTED LINE, WITH ZERO-SEQUENCE COUPLING

General Applicability

The double-circuit configuration, where both circuits share the same right of way, is common enough so as to deserve special attention. Here the restriction to two 3-conductor circuits is made, for a total of six phases or conductors for the components. The modeling option of this section assumes that the circuits are themselves individually continuously transposed, but that there is inter-circuit zero-sequence coupling. As such, it is a special 6-conductor extension to the continuously-transposed distributed-parameter transmission line modeling of Section 1.26 .

Zs	Zm	Zm	Zm	Zm	Zm
Zm	Zs	Zm	Zm	Zm	Zm
Zm	Zm	Zs	Zm	Zm	Zm
Zm	Zm	Zm	Zs	Zm	Zm
Zm	Zm	Zm	Zm	Zs	Zm
Zm	Zm	Zm	Zm	Zm	Zs

Fig. 1 Matrix structure assuming continuous transposition.

Zs	Zm	Zm	Zp	Zp	Zp
Zm	Zs	Zm	Zp	Zp	Zp
Zm	Zm	Zs	Zp	Zp	Zp
Zp	Zp	Zp	Zs	Zm	Zm
Zp	Zp	Zp	Zm	Zs	Zm
Zp	Zp	Zp	Zm	Zm	Zs

Fig. 2 Structure of matrices for new double-circuit line having zero-sequence coupling between circuits.

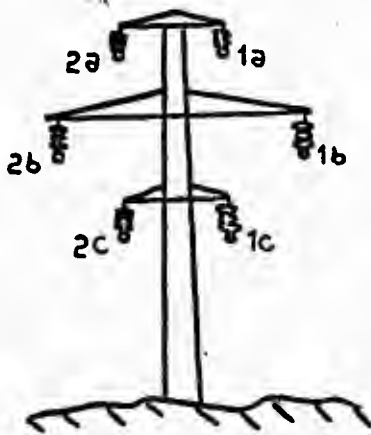

Fig. 3 Double-circuit line supported by a single tower.

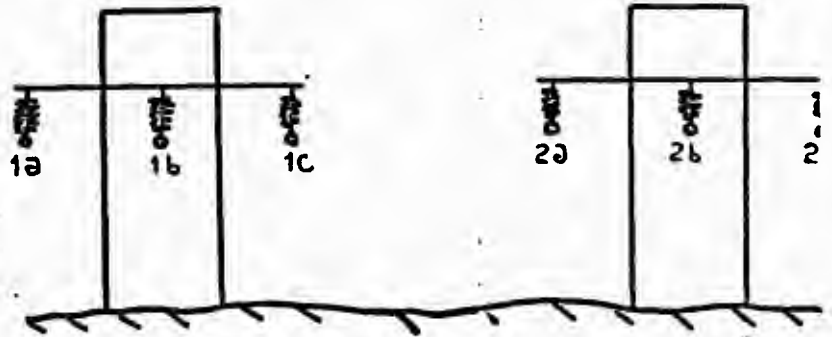

Fig. 4 Double-circuit line where each circuit is supported by its own tower.

This special double-circuit representation is an approximation of course, but the idea is not too different from approximating a transposed single-circuit line as a balanced line, rather than representing it as three untransposed sections.

In general terms, the special double-circuit representation of this section is to be preferred if the two circuits are physically separated, as in Fig. 4; if both circuits are supported by the same tower as in Fig. 3, it is questionable if any advantage over the conventional continuously-transposed representation of Section 1.26 .

Mathematics of Double-Circuit Model

Mathematically, the coupling (resistive, inductive, and capacitive; we use the general symbol "Z" simply for illustration) between phases is assumed to have the structure of Fig. 2, where three distinct parameters are seen to be allowed. This is to be contrasted with the continuously-transposed model of Fig. 1, where there are only two distinct parameter values. Several specific points concerning this difference follow:

Point 1: The two circuits of the double-circuit component representation are assumed to be identical. That is, rows and columns 1, 2, and 3 of Fig. 2 can be interchanged (permuted) with those of 4, 5, and 6 without altering the matrix. In Fig. 5, the two 3 x 3 diagonal submatrices [Z(1,1)] and [Z(2,2)] are identical.

Z(1,1)	Z(1,2)
Z(2,1)	Z(2,2)

Point 2: Z_s and Z_m are the self and mutual coupling associated with either one circuit taken separately.

With variable grouping after row and column 3 in Fig. 2, the partitioned matrix form or structure of Fig. 5 results. Note that [Z(1,1)] and [Z(2,2)] each are of the form of Section 1.26, which means mathematically that each circuit taken individually is continuously transposed.

Fig. 5. Partitioned form of matrix of Fig. 2 (each block is 3 x 3).

Point 3: All elements of [Z(1,2)] or [Z(2,1)] are equal to the same value Z_p ---- the mutual coupling between any one of the three conductors of one circuit and any one of the three conductors of the other circuit.

Point 4: The three distinct phase coupling parameters Z_s , Z_m , and Z_p can be indirectly specified by means of the three distinct modal coupling parameters Z_G , Z_L , and Z_{IL} . The relationship is:

$$\begin{aligned} Z_G &= Z_s + 2Z_m + 3Z_p \\ Z_L &= Z_s - Z_m \\ Z_{IL} &= Z_s + 2Z_m - 3Z_p \end{aligned}$$

Here Z_G is the ground-mode parameter, identical to the value for the zero-sequence mode of the continuously-transposed line of Section 1.26 if parameters Z_p and Z_m happen to be equal (so that the six conductors actually are continuously transposed). Parameter Z_L is identical with the familiar line-mode of the continuously-transposed line, always, and has modal multiplicity

of four. Finally, parameter ZIL is completely new, a line mode associated with intercircuit zero-sequence coupling.

Point 5: The following transformation matrix, which converts the current and voltage between the phase and modal domains, was found by Hermann Dommel (see EMTP Newsletter, Vol. 2, No. 3, Feb., 1982, p. 57):

$$[Ti] = \frac{1}{\sqrt{6}} \begin{bmatrix} 1 & 1 & \sqrt{3} & 1 & 0 & 0 \\ 1 & 1 & -\sqrt{3} & 1 & 0 & 0 \\ 1 & 1 & 0 & -2 & 0 & 0 \\ 1 & -1 & 0 & 0 & \sqrt{3} & 1 \\ 1 & -1 & 0 & 0 & -\sqrt{3} & 1 \\ 1 & -1 & 0 & 0 & 0 & -2 \end{bmatrix}$$

with

$$[Ti]^{-1} = [Ti]^t$$

and

$$[Tv] = [Ti]^{-1} = [Ti]^t$$

EMTP Data Format for Double-Circuit Distributed Line

Data preparation and input for the double-circuit distributed-parameter line component is the same as that for a continuously-transposed line (see Section 1.26) of six conductors, except for the following:

Comment 1: The three conductors of one of the circuits must be numbered -1, -2 and -3; conductors of the other circuit are then numbered -4, -5, and -6.

Comment 2: Modal parameter values are to be punched on the first three data cards (corresponding to the conductors -1, -2, and -3) in the following order:

- a) The "G" mode goes on the card of conductor 1, and the "L" mode goes on the card of conductor number 2. Note that for the special case of Zp and Zs being equal, this data input is absolutely identical to what would have been done for the continuously-transposed line model.
- b) The "IL" mode goes on card number 3 (that for the third conductor).
- c) Cards 4 through 6 are to be left blank, for columns 27-80.

The fields and units used for such data of columns 27-80 are identical to those for the constant distributed parameter line.

The resulting impedance matrix [Z] for 50 Hz is then found to be:

.....
 FOLLOWING MATRICES ARE FOR EARTH RESISTIVITY= 100.00 OHM-M AND FREQUENCY= 50.00 HZ. CORRECTION FACTOR= .000001
 *****EARTH WIRES WILL BE SEGMENTED*****

.....
 IMPEDANCE MATRIX (OHM/MILE) FOR THE SYSTEM OF EQUIVALENT PHASE CONDUCTORS
 ROWS AND COLUMNS PROCEED IN SAME ORDER AS SORTED INPUT

1	1.03245E-01 0.95642E-01				
2	7.59474E-02 4.53672E-01	1.01654E-01 4.97224E-01			
3	7.66662E-02 4.31747E-01	7.59864E-02 4.53669E-01	1.03246E-01 4.95656E-01		
4	7.64993E-02 3.26215E-01	7.59673E-02 3.42918E-01	7.66138E-02 3.76628E-01	1.03246E-01 4.95656E-01	
5	7.57431E-02 3.09823E-01	7.51370E-02 3.27795E-01	7.58673E-02 3.42918E-01	7.59444E-02 4.57649E-01	1.01654E-01 4.97224E-01
6	7.63682E-02 2.95779E-01	7.57431E-02 3.08823E-01	7.64993E-02 3.26215E-01	7.55662E-02 4.11747E-01	7.59839E-02 4.53672E-01

An arithmetic averaging of these elements so as to fit the Fig. 4 model produces the following mean values:

$$\bar{Z}_g = 1.02782E-01 + j8.96182E-01$$

$$\bar{Z}_m = 7.62115E-02 + j4.46363E-01$$

$$\bar{Z}_p = 7.60354E-02 + j3.27722E-01$$

Deviations of the actual values from these mean values then are summarized by the following statistics:

Quantity	Maximum fractional deviation from the sample mean, $\max \left \frac{Z - \bar{Z}}{\bar{Z}} \right $	Sample standard deviation as fraction of sample mean, $\frac{\sqrt{\sum (Z - \bar{Z})^2 / N}}{\bar{Z}}$
R_g, L_g	0.90% , 0.12%	0.63% , 0.08%
R_m, L_m	0.60% , 3.27%	0.42% , 2.32%
R_p, L_p	1.18% , 9.75%	0.60% , 6.43%

It is the average values just stated which are next converted to modal values, using the formulas of Point 4. One finds $.483311 + j2.772074$, $.0270988 + j.805742$, and $.0265705 + j.449819$ for modes "G", "IL", and "L" , respectively.

An analogous calculation would of course have to be performed for the capacitance matrix. Then, having modal values for R, L, and C, data cards for the line could be punched as per the preceding Comment 2.

1.26b FREQUENCY DEPENDENCE FOR DISTRIBUTED-PARAMETER LINE

Over the past few years, there have been numerous research efforts devoted to the frequency-dependent modeling of the distributed-parameter lines. Five such models have been implemented in the EMTP. Starting from the Meyer-Dommel's Weighting Function Model in 1974, then came the Semlyen's Recursive Convolution Model (see point 2 of Section 0.2) and Ametani's Linear Convolution Model in 1976 (see point 8 of Section 0.2), Hauer's Model in 1979 (see point 9 of Section 0.2), and most recently, the Marti's Model was implemented in the EMTP in 1981 (see point 10 of Section 0.2).

1.26b1 Marti's Model

During 1977 and August of 1981, Prof. Jose R. Marti of Central University of Venezuela (Caracas) was on a leave of absence while he worked toward his doctorate in Vancouver, studying under Prof. Hermann Dommel. His Ph.D. dissertation was concerned with a new, simplified procedure for the frequency dependent representation of transmission lines in a transients program. Through a contract with BPA, Jose started implementing his new procedure in the EMTP in August, 1981. Although some work remains (the contract with Jose will be completed in December, 1982), useful results have already been obtained.

Jose summarized the theory of his model in an EMTP Newsletter article entitled: Implementation At BPA Of A New Frequency-Dependence Model (Volume 2, Number 3, February 1982, pp. 33 - 37). A copy of this article is printed in the following:

IMPLEMENTATION AT BPA OF A NEW FREQUENCY-DEPENDENCE MODEL

José R. Martí

School of Electrical Engineering, Central University of Venezuela
(Universidad Central de Venezuela, Escuela de Ingeniería Eléctrica,
Caracas, Venezuela)

Introduction

In the September 1981 issue of the EMTP Newsletter, Tsu-huei commented on the progress made at BPA during the Summer of 1981 in the implementation on a production basis of the frequency-dependence line model introduced in references (1) and (2). Some of the theoretical aspects of the model and its interfacing with the EMTP will be elaborated further in this article.

Line Equivalent Circuit

The basic conceptual form of the model, for a given line mode, is shown in fig. 1(a) for end k of the line (an analogous model corresponds to end m). The final reduced form, compatible with the network representation in the EMTP, is shown in fig. 1(b).

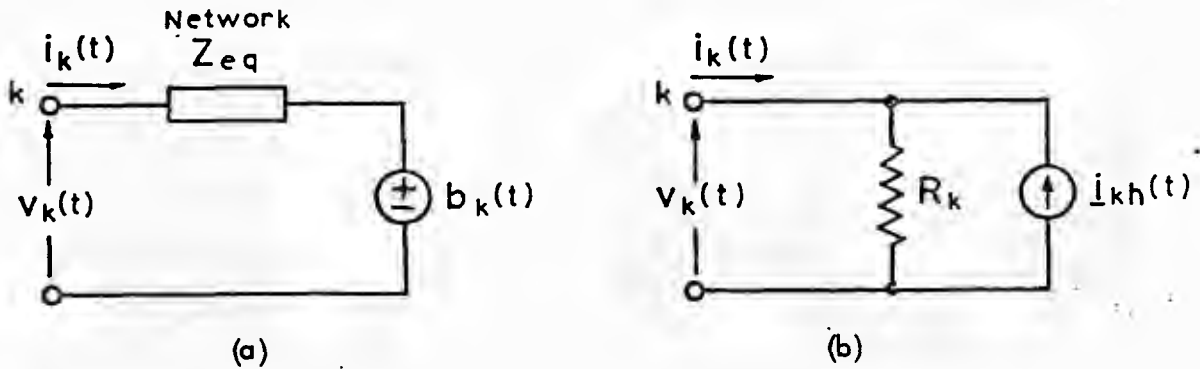

Fig. 1: Frequency-dependence line model. (a) Basic form. (b) Reduced form.

Network Z_{eq} :

In fig. 1(a), the network Z_{eq} consists of R-C blocks as shown in fig. 2. The frequency response of this network duplicates the frequency response of the characteristic impedance, that is, $Z_{eq}(\omega) = Z_c(\omega)$. The number of R-C blocks and the parameters of the network result from the approximation of $Z_c(s)$ (s is the complex variable) by a rational function of the form

$$Z_{eq}(s) = H \frac{(s + z_1)(s + z_2) \dots (s + z_n)}{(s + p_1)(s + p_2) \dots (s + p_n)}, \quad (1)$$

where the zeroes ($-z_i$) and the poles ($-p_i$) are real, negative, and distinct.

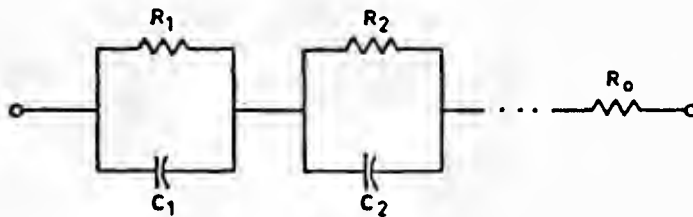

Fig. 2 : R-C network to synthesize Z_c .

History voltage source $b_k(t)$:

The equivalent voltage source $b_k(t)$ in fig. 1(a) represents the weighted effect upon end k of past values of current and voltage at end m . This weighting accounts for the different travelling times and attenuations of the different frequency components of the travelling waves. The source $b_k(t)$ is defined (2) as

$$b_k(t) = \int_{-\infty}^t f_m(t-u) a_1(u) du, \quad (2)$$

where $f_m(t) = 2v_m(t) - b_m(t)$ and the weighting function $a_1(t)$ is the time-domain form of the line response function $A_1(\omega) = e^{-\gamma(\omega)t}$.

In order to avoid the numerical difficulties involved in obtaining $a_1(t)$ from an Inverse Fourier Transformation of $A_1(\omega)$ and the numerical burden of accurately evaluating the convolution integral in eqn. 2 at each time step of the network solution, the function $A_1(\omega)$ is approximated in the complex plane by a rational function of the form

$$\begin{aligned}
 A_{1a}(s) &= P_a(s) e^{-s\tau} \\
 &= H \frac{(s+z_1)(s+z_2) \dots (s+z_n)}{(s+p_1)(s+p_2) \dots (s+p_m)} e^{-s\tau},
 \end{aligned} \tag{3}$$

where $m > n$ and, as in the case of $Z_{eq}(s)$, the zeroes and poles are real, negative, and distinct. For $s = j\omega$, the phase displacement τ represents the phase difference between $A_{1a}(\omega)$ and its associated minimum-phase-shift function $P_a(\omega)$. From eqn. 3, $a_1(t)$ is obtained directly in closed-form as a sum of exponentials with a time delay τ :

$$a_1(t) = \left[k_1 e^{-p_1(t-\tau)} + k_2 e^{-p_2(t-\tau)} + \dots + k_m e^{-p_m(t-\tau)} \right] U(t-\tau). \tag{4}$$

Since convolution with exponentials can be evaluated recursively (e.g. (3)), the voltage source $b_k(t)$ can be expressed as

$$b_k(t) = \sum_1^m b_{ki}(t), \tag{5}$$

with

$$b_{ki}(t) = m_i b_{ki}(t-\Delta t) + p_i f_m(t-\tau) + q_i f_m(t-\tau-\Delta t),$$

where m_i , p_i , and q_i are constants that depend on the residuals and poles of $P_a(s)$ in eqn. 3 and on the time step Δt of the network solution.

Asymptotic Tracing Technique to Obtain the Rational Functions

The rational functions $Z_{eq}(s)$ and $P_a(s)$ in eqns. 1 and 3 are obtained directly from an asymptotic tracing of the corresponding magnitude functions $|Z_c(\omega)|$ and $|A_1(\omega)|$ on log-log scales. The procedure is illustrated in fig. 3 for a typical shape of the zero sequence mode of $Z_c(\omega)$.

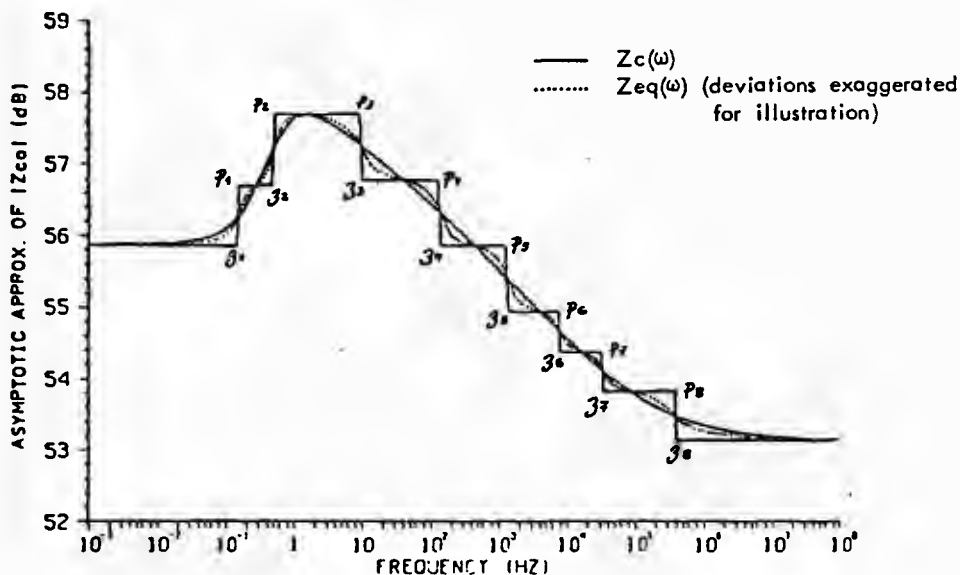

Fig. 3 : Asymptotic tracing of $Z_c(\omega)$ to obtain $Z_{eq}(\omega)$.

If the magnitude function is expressed in dB ($20 \log |Z_c(\omega)|$), then straight line segments with a slope of either zero or a multiple of 20 dB/decade will constitute an envelope for the rational function. That is, the rational function Z_{eq} (dotted line) is contained between Z_c and the asymptotes. The corners of the asymptotic envelope define the location of the zeroes and poles of the rational function. The construction of the asymptotic envelope can be visualized as follows. Starting from a horizontal reference level, every time a zero corner is added the slope of the envelope will increase in 20 dB/dec; when a pole corner is added, the slope will decrease in 20 dB/dec. How close the resulting rational function is to the data curve $Z_c(\omega)$ will depend on how far the asymptote is allowed to separate from the data curve before the next corner is added. (Actually, there is a limit on how close the corners can be from each other; excessive crowding will inhibit the envelope properties of the asymptotes.)

Time Delay τ

The time delay τ in $a_1(t)$ (eqn. 4) is obtained directly in the frequency domain by comparing the phase angle of the minimum-phase-shift function $P_a(\omega)$ with the phase angle of the data function $A_1(\omega)$. From eqn. 3, it follows that

$$\phi_{A_1}(\omega) = \phi_{P_a}(\omega) - \omega\tau,$$

from where

$$\tau = \frac{\phi_{P_a}(\omega) - \phi_{A_1}(\omega)}{\omega} \quad (6)$$

If the approximation were exact, eqn. 6 would give the same value of τ for any ω . In practice, even though the deviations are very small, an average value of τ is obtained.

Reduced Form of the Line Equivalent Circuit

Once the parameters of the basic equivalent circuit of fig. 1(a) have been identified, that is, Z_{eq} has been defined from eqn. 1 and the parameters of the recursive relationship to evaluate $b_k(t)$ in eqn. 5 have been found from eqn. 3, the circuit of fig. 1(a) is reduced by algebraic combinations to the simple circuit of fig. 1(b).

Implementation of the Model in the EMTP

a) Generation of the parameters of the equivalent circuit:

The generation of the parameters for the line equivalent circuit can be summarized as follows:

i) Through the Line Constants routine in the EMTP generate the modal parameters required to evaluate the functions $Z_c(\omega) = \sqrt{[R'(\omega) + j\omega L'(\omega)]/[G' + j\omega C']}$ and $A_1(\omega) = e^{-\gamma(\omega)l}$ (with $\gamma(\omega) = \sqrt{[R'(\omega) + j\omega L'(\omega)][G' + j\omega C]}$).

ii) The functions $Z_c(\omega)$ and $A_1(\omega)$ are processed by the fitting routines to obtain the corresponding rational approximations. The residuals and poles of a partial fractions expansion of these functions and the time delay τ define the parameters of the equivalent circuit.

b) Processing of frequency-dependent lines in the transients simulation:

The input "cards" for each line mode contain the model parameters obtained from the fitting routines. The supporting routines for the processing of frequency-dependent lines perform the following tasks:

- i) Evaluation of the parameters of the reduced line model (fig. 1(b)).
- ii) Initialization of the history vectors from steady-state ac or dc conditions. (In order to ensure a smooth transition between sinusoidal steady-state conditions and the transient simulation, the line power frequency parameters are regenerated from the parameters of the model).
- iii) Updating of the history vectors at each time step of the network solution.

Contributions

The solution code to interface the new line model with the EMTP was first extended to include all the line modes and user-defined dc initial conditions by Luis Martí in the University of British Columbia version of the program. The implementation in the larger BPA code was completed during the author's stay at BPA in the Summer of 1981 with the assistance of Tsu-huei Liu and W. Scott Meyer. The fitting routines developed at UBC were interfaced with the BPA code on a first stage by John Abramson early in the Summer of 1981, and later on further developed and tested by the author. Since then, computational improvements have been added by Scott and Tsu-huei.

Closing Remarks

The line models described in this article are valid under the assumption that the line equations can be decoupled by constant transformation matrices. In practice this seems to be a reasonable assumption for most cases of overhead transmission lines. For the more general case of frequency-dependent transformation matrices (specially critical for cable systems), the corresponding extensions are still to be done. It is expected that Luis Martí will undertake this job as his Ph.D. thesis at UBC under the supervision of Prof. Hermann W. Dommel.

References

- (1) J.R. Martí, "New Approach to the Problem of Frequency Dependence of Transmission Line Parameters". EMTP Newsletter, Vol. 1(3), pp. 17-20, April 1980.
- (2) J.R. Martí, "Accurate Modelling of Frequency-Dependent Transmission Lines in Electromagnetic Transients Simulations". Proc. IEEE Power Industry Computer Applications (PICA) Conference, Philadelphia, PA, 9 pages, May 1981.
- (3) A. Semlyen and A. Dabuleanu, "Fast and Accurate Switching Transient Calculations on Transmission Lines with Ground Return using Recursive Convolutions". IEEE Trans., PAS-94, pp. 561-571, March/April 1975.

15 m

NPZ -- The number of poles of the characteristic impedance Z_c .
 AKOZC - The value of Z_c at infinite frequency.

Rule 3: Then come a number of cards which carry the values of the residues of NPZ poles of Z_c . Each card can carry up to 3 residues in the format of E26.0 .

VOLTBC(I)	VOLTBC(I+1)	VOLTBC(I+2)
E26.0	E26.0	E26.0

Rule 4: The values of all the poles of Z_c are inputted in the format of E26.0 . The corresponding residues are inputted under Rule 3.

VOLTBC(I)	VOLTBC(I+1)	VOLTBC(I+2)
E26.0	E26.0	E26.0

Rule 5:

NPA	TAU
I8	E32.20

NPA: The number of poles of the Weighting Function A_1 of the branch.

TAU: The travel time of the branch.

Rule 6: Same format as described in Rule 3. Only now the residues are for the poles of the Weighting Function A_1 .

Rule 7: Same format as described in Rule 4. Only now the poles are for A_1 .

Rule 8: Repeat the data cards from Rule 1 to Rule 7 for each of the Marti's branches.

Rule 9: Only when IPOSE is nonzero on Marti's branch card, the transformation matrix $[T_i]$ is read in after all the Marti's branch cards are inputted according to Rules 1 to 8. The elements of $[T_i]$ are read in by rows (row 1 first, then row 2, etc.). For a given row, the real part of the element for all columns come first; then the imaginary part follows by starting on a new card. Within each row, elements are read in the order of increasing column number. Each row begins with a new card, and there are 6 or fewer elements per card.

TI(J,K)	TI(J,K+1)	TI(J,K+2)	TI(J,K+3)	TI(J,K+4)	TI(J,K+5)
E12.0	E12.0	E12.0	E12.0	E12.0	E12.0

15 n

If the transmission line had only 3 phases, the final three fields (columns 37 - 72) would not be used. For N less than or equal to 6, exactly 2N data cards for [Ti] are involved; for N greater than or equal to 7, and less than or equal to 12, exactly 4N data cards are involved, etc. Note that there must be exactly 2*N*N elements for [Ti].

The following is an example of a set of Marti's branch cards which are generated on the punched output by running the "JMARTI SETUP" of the untransposed 500 KV John-Day to Lower Monumental line:

```
C      PUNCHED CARD OUTPUT OF "JMARTI SETUP" WHICH BEGAN AT 09.11.53 12/23/82
C 1.3636 .05215 4      1.602 -20.75 50.      50.
C 1.3636 .05215 4      1.602 -19.25 50.      50.
C 2.3636 .05215 4      1.602 - 0.75 77.5     77.5
C 2.3636 .05215 4      1.602  0.75 77.5     77.5
C 3.3636 .05215 4      1.602 19.25 50.      50.
C 3.3636 .05215 4      1.602 20.75 50.      50.
C 0.5    2.61  4      0.386 -12.9 98.5     98.5
C 0.5    2.61  4      0.386 12.9 98.5     98.5
C
C 100.    5000.    1      138.      1      3-2
C 100.    60.00    1      138.      1      3
C 100.    .01      1      138.      1  9 10  3
C
-LJDA  LMA      2.      -2 3
      18      0.47487144790587633736E+03
-0.117967342612603676E+01 -0.316671345021416945E+01 0.255662317832426673E+02
-0.601654631032706213E+02 -0.118825306534453652E+03 0.128169142098635430E+04
0.589610442538186533E+04 0.292891488173549769E+05 0.115665757459954655E+06
0.456394278488149546E+06 0.153681652821077613E+07 0.681848054466802243E+07
0.155477562610202006E+08 0.231789897204889809E+08 0.143827766961221036E+08
0.241524708800130989E+08 0.245049034784953832E+08 0.476808364145524129E+08
0.321645453133055891E+00 0.897616891499021768E+00 0.165632367032913183E+01
0.166669419493737986E+01 0.253073682990780913E+01 0.200014655383098283E+02
0.124257951002701473E+03 0.657345842950598183E+03 0.278623017775457413E+04
0.117145310573639467E+05 0.427410884649070877E+05 0.202553264108715757E+06
0.968789502295299084E+06 0.296908522006270138E+07 0.737968316276072920E+07
0.121009167337626640E+08 0.132891445947112725E+08 0.252097199908134253E+08
      14      0.86849922355034161602E-03
0.580543547692027378E-01 0.269744993210893937E+00 0.358646519088160871E+00
0.775351125410303321E+00 0.512138885239558117E+01 0.838265420474254408E+01
0.700229782114551433E+02 0.393084113996384431E+03 0.138208543918962764E+04
0.706160326497019952E+03 0.527246586822120025E+04 0.528343251309080315E+05
0.178307801042244462E+08 -0.178914532139214980E+08 0.139222638455845416E+03
0.228360173022402559E+02 0.102750699821169642E+03 0.427793721751318543E+03
0.269608322018776349E+03 0.389220463867018758E+03 0.449341296469570784E+04
0.132148883486994569E+04 0.277178340638843952E+04 0.268314807408425609E+05
0.596603161966094046E+04 0.114714152641659609E+05 0.204231841543429041E+05
0.204027813729699374E+05 0.204231841543429041E+05
```

-2JDB	IMB	2.	-2 3
13	0.28580875773089412917E+03		
0.381761604345213937E+04	-0.269529222495194256E+04	0.445018224900628987E+03	
0.214658130219351957E+03	0.897325461203548596E+02	0.130480129629523557E+03	
0.683037485206981145E+02	0.746626715384042328E+02	0.133938729387751823E+04	
0.249954495902360986E+04	0.187764116219513962E+05	0.391031620802855847E+06	
0.562668431190422236E+07			
0.358668999787749571E+01	0.376679186833120605E+01	0.706439034439901681E+01	
0.109721634064781408E+02	0.140506334140286906E+02	0.234292596911152278E+02	
0.407686998675835062E+02	0.797598814775078377E+02	0.129106739969348092E+04	
0.242138030939135882E+04	0.182362646041542152E+05	0.379814243183306942E+06	
0.548808385606378876E+07			
13	0.74123751236187225360E-03		
0.192189595814866117E+02	0.210970481418780736E+01	0.383406546226878246E+02	
0.307999912886148377E+02	0.634013410317135580E+03	-0.253243195247025884E+03	
0.210540381301789585E+05	0.755533947306501213E+05	0.229576557459445205E+07	
0.607777584135430078E+13	-0.156620677810577402E+13	0.153143851607148541E+13	
-0.604300997216426831E+13			
0.325736126030671659E+04	0.366694913707514225E+03	0.675727697588602007E+04	
0.516024976370228876E+04	0.249456113770459356E+05	0.115067772934717425E+06	
0.105205466546493019E+06	0.240930799961836921E+06	0.633276538663731422E+06	
0.975820481990593078E+06	0.976796302472583702E+06	0.974176721795814519E+06	
0.975150898517610403E+06			
-3JDC	LMC	2.	-2 3
13	0.27248404992352929810E+03		
0.928429573805074611E+03	0.205756155237143687E+03	0.538106630554037494E+03	
0.105199818376817797E+03	0.821382476778668842E+02	0.133356875032521739E+03	
0.654774478488469374E+02	0.612546121562179922E+02	0.905544916173387175E+02	
0.973244316091135431E+03	0.267481871266201114E+04	0.138566411938941123E+05	
0.646075558955915112E+06			
0.297277477955690506E+01	0.413177069940672703E+01	0.739410817322770542E+01	
0.103072536754268027E+02	0.135874091964585511E+02	0.234792992956042879E+02	
0.384075708508238112E+02	0.692539345057236382E+02	0.997101922255402737E+02	
0.941460937860312015E+03	0.259295974388396348E+04	0.134538093446956691E+05	
0.628668738677182439E+06			
20	0.74871165651714267344E-03		
0.249456855794677125E-01	0.516637614002143797E+01	0.435227595525510835E+01	
0.696293545843378914E+01	0.113102519337405696E+02	0.107077756312168011E+02	
0.136526319661979056E+02	0.103057494642840895E+03	0.647491597081197526E+03	
0.221213037293260840E+04	0.164010494681972168E+05	0.517776934139508994E+05	
0.393233870054797451E+06	-0.101893253559274110E+05	-0.173413454816460973E+06	
0.524218185885896666E+06	0.711044562955652374E+12	-0.559640645251948380E+12	
0.582892127161347656E+12	-0.734296849907926895E+12		
0.887741958857318814E+01	0.183177145564733635E+04	0.151655674045953921E+04	
0.245910936284398730E+04	0.383273362703089043E+04	0.399285585783856465E+04	
0.496339281485561617E+04	0.253464455063045348E+05	0.272156609769823021E+05	
0.475215596432249567E+05	0.149791320991727040E+06	0.333884409922466803E+06	
0.541583000670874200E+06	0.670984155731562481E+06	0.569769858667429973E+06	
0.132622344670840449E+07	0.440534234233556024E+07	0.440974768467789621E+07	
0.436787151891064155E+07	0.437223939042955241E+07		
0.57154434	0.70710678	-0.41761362	---- real part of row 1 of [Ti]
0.00000000	0.00000000	0.00000000	---- imag. part of row 1 of [Ti]
0.58879039	0.00000000	0.80696823	
0.00000000	0.00000000	0.00000000	
0.57154434	-0.70710678	-0.41761362	Etc.
0.00000000	0.00000000	0.00000000	

1.27 Recursive Convolution Frequency Dependence

Modal wave propagation for overhead lines has a frequency response characteristic resembling that of a low-pass filter in series with a pure time delay τ . Figure A below is typical. Characteristic

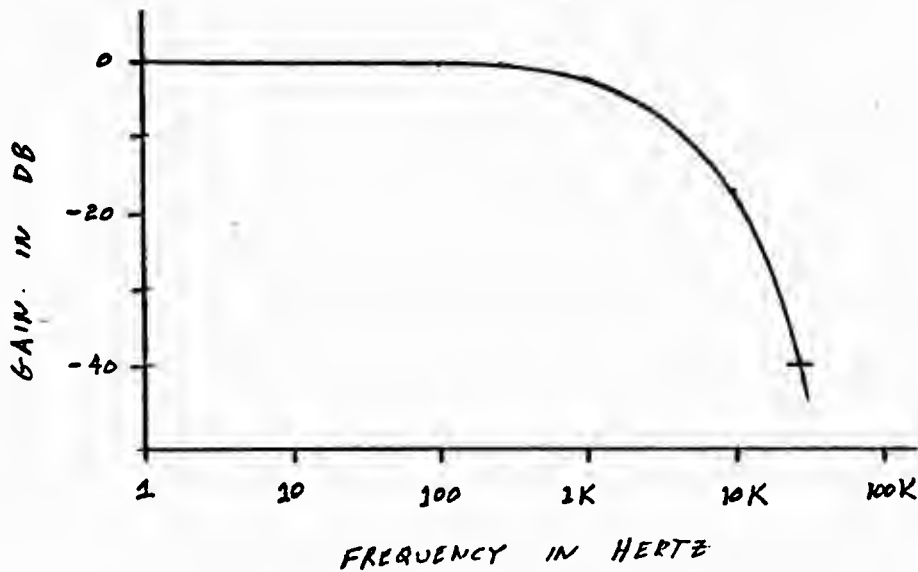

Figure A. Typical gain response for wave propagation

admittance, on the other hand, exhibits an initial \sqrt{f} behavior up to a "knee" somewhere around 1Hz. (Figure B). The upper modes often have y_0 essentially constant above 10Hz. For mode 1, however, y_0 may roughly double between 10Hz and response data cutoff (at -40 db).

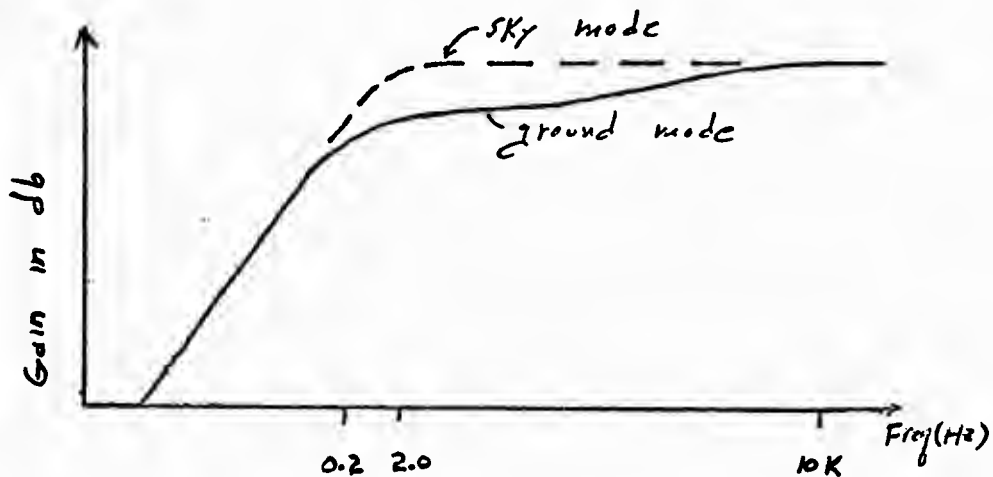

Figure B. Typical gain response for characteristic admittance

Models for wave propagation and characteristic admittance are specified by \hat{z} and the transfer function

$$T(s) = \frac{G(s-z_1) \dots (s-z_m)}{(s-p_1) \dots (s-p_n)} \tag{1A}$$

$$= K_{ff} + \sum_l \frac{K_l}{(s-p_l)} \tag{1B}$$

$$= K_{ff} + \sum_L \frac{\hat{K}_L / P_L}{(s - P_L)} \quad (1c)$$

where Z_L , P_L are the zeros and poles of $T(s)$; K_L and \hat{K}_L are the residues of $T(s)$ for impulse and step inputs respectively.

For the wave-propagation model the feedforward coefficient K_{ff} is zero, and τ is approximately the line travel time. The admittance model has $\tau = 0$, and K_{ff} approximates the high-frequency value of y_0 . Following "SEMLYEN SETUP" conventions, each transfer function is represented on cards by partial-fraction expansion (Eq. 1c).

1.27a Data Requirements for Recursive Convolution Representation

The original Recursive Convolution modeling code was contributed by Ontario Hydro of Toronto, Ontario, Canada. Please see Section 0.2, item 2 for additional information.

Suppose that the user wants to specify an N-conductor distributed-parameter transmission circuit which is modeled using Recursive Convolution. He should first procure the punched-card output of a "SEMLYEN SETUP"

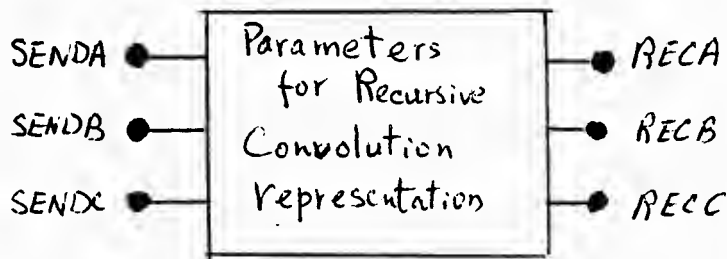

run which corresponds to the geometry (including line length and ground resistivity) and steady-state frequency of interest. A full discussion will be found in Section 7.5

Such cards will hopefully conform to the following rules:

Rule 1: There is to be a branch card for each phase (mode), punched according to the following format:

1	2	3	4	5	6	7	8	9	10	11	12	13	14	15	16	17	18	19	20	21	22	23	24	25	26	27	28	29	30	31	32	33	34	35	36	37	38	39	40	41	42	43	44	45	46	47	48	49	50	51	52	53	54	55	56	57	58	59	60	61	62	63	64	65	66	67	68	69	70	71	72	73	74	75	76	77	78	79	80
ITYPE	BUS1		BUS2		y_0					τ					N1	N2	N3	N4	N5	IOLT																																																											
I2	A6		A6		E12.5					E12.5					I3	I3	I3	I3	I4	I																																																											

ITYPE = -1 ---- Type code for branch.

BUS1 } ---- Six-character alphanumeric node names. The
 BUS2 } sending and receiving ends of the branch under
 consideration are to be connected to these two
 network nodes, respectively.

y_0 ---- Infinite-frequency characteristic admittance (K_{ff}
 in Eq. 1c)

Each of these cards specifies two partial fractions (See Eq. 1c). Let the mth pole P_m be defined as $P_m = -\sigma_m + j\omega_m$, where both σ_m and ω_m are positive, and let the corresponding residue \hat{K}_m be defined as $\hat{K}_m = \hat{K}_{r,m} + \hat{K}_{i,m}$. Then two real poles P_m and P_{m+1} can be specified on one such card where

$$\begin{aligned} \text{VOLT}(1) &= 0.0, & \text{VOLT}(2) &= \sigma_m, & \text{VOLT}(3) &= -\hat{K}_{r,m} \\ \text{VOLT}(4) &= 0.0, & \text{VOLT}(5) &= \sigma_{m+1}, & \text{VOLT}(6) &= -\hat{K}_{r,m} \end{aligned}$$

On the other hand, one whole card is needed for each of the complex pole P_m :

$$\begin{aligned} \text{VOLT}(1) &= 1.0, & \text{VOLT}(2) &= \sigma_m, & \text{VOLT}(3) &= -\hat{K}_{r,m} \\ \text{VOLT}(4) &= -1.0, & \text{VOLT}(5) &= -\omega_m, & \text{VOLT}(6) &= -\hat{K}_{i,m} \end{aligned}$$

Rule 4: The cards under Rules 1, 2, and 3 are repeated for each branch (or phase or mode), in order.

Rule 5: Following the cards of Rule 4 are to come records which define the voltage transformation matrix $[T_V]$, where

$$\vec{V}_{\text{phase}} = [T_V] \cdot \vec{V}_{\text{mode}}$$

Complex Matrix elements are inputted by rows, in natural order (row #1 first, then row #2, etc.) and are in terms of the real and imaginary pairs. However, the imaginary part of each element is set to be zero. Within any row, elements are inputted in order of increasing column number. Each row begins with a new card, and there are six or fewer numbers per card. The following format is applicable to row "K" for a 3-phase transmission circuit:

$TV_{K,1}^r$	$TV_{K,1}^i$	$TV_{K,2}^r$	$TV_{K,2}^i$	$TV_{K,3}^r$	$TV_{K,3}^i$
E12.5	E12.5	E12.5	E12.5	E12.5	E12.5

Rule 6: Following the cards of Rule 5, there is a second such grouping, only for the current transformation matrix $[T_i]$, where

$$\vec{I}_{\text{phase}} = [T_i] \cdot \vec{I}_{\text{mode}}$$

The number of elements and their ordering is identical to that for the voltage transformation matrix, which has just been described.

$TI_{K,1}^r$	$TI_{K,1}^i$	$TI_{K,2}^r$	$TI_{K,2}^i$	$TI_{K,3}^r$	$TI_{K,3}^i$
E12.5	E12.5	E12.5	E12.5	E12.5	E12.5

Rule 7: The column-80 punch on the branch cards (see "IOUT" of Rule 1) must always be supplied by the user if branch output variables for a Recursive Convolution line are desired. The punched-card output of "SEMLYEN SETUP" will always leave column 80 of the branch cards blank (corresponding to no such output).

An example of punched output from running "HAUER SETUP":

```

C 1.3636 .05215 4 1.602 -20.75 50. 50.
C 1.3636 .05215 4 1.602 -19.25 50. 50.
C 2.3636 .05215 4 1.602 -0.75 77.5 77.5
C 2.3636 .05215 4 1.602 0.75 77.5 77.5
C 3.3636 .05215 4 1.602 19.25 50. 50.
C 3.3636 .05215 4 1.602 20.75 50. 50.
C 0.5 2.61 4 0.386 -12.9 98.5 98.5
C 0.5 2.61 4 0.386 12.9 98.5 98.5
C
C 27. 60. 1 138.
C 27. 6.0 1 138. 9 20
C
-1BEGINAENDA 0.16087E-02 0.74835E-03 1 1 14 2 3
0.67519497E+02 0.22868008E+03 0.00000000E+00 0.62996694E-03 0.60000000E+02
0., 0.23272840E+03, 0.505695185E-01, 0., 0.61827942E+03, 0.748306243E-01
0., 0.460330237E+04, 0.227732022E+00, 0., 0.873771583E+04, -0.587245219E-01
0., 0.900430932E+04, 0.249999225E-01, 0., 0.159407707E+05, 0.975160389E+00
0., 0.194752175E+05, 0.117242152E+00, 0., 0.366005345E+05, 0.548528443E+00
0., 0.654818466E+05, -0.150033701E+01, 0., 0.212800153E+06, 0.120734101E+02
0., 0.271680247E+06, -0.185580738E+05, 0., 0.273142633E+06, 0.342711488E+05
0., -0.275102479E+06, -0.160808604E+05, 0., 0.287226841E+06, 0.356251978E+03
0., 0.000000000E+00, 0.000000000E+00, 0., 0.000000000E+00, 0.000000000E+00
-1BEGINBENDB 0.35258E-02 0.74318E-03 2 2 14 2 3
0.40944359E+01 0.80845419E+02 0.00000000E+00 0.10069636E-02 0.60000000E+02
0., 0.827674470E+03, 0.398806056E-01, 0., 0.130501996E+06, 0.508365787E+00
0., 0.252780509E+06, -0.280985689E+00, 0., 0.260749831E+06, 0.360866589E+00
0., 0.544371051E+06, -0.152645223E+01, 0., 0.696229069E+06, 0.773993647E+01
0., 0.768161125E+06, -0.566855648E+01, 0., 0.415043368E+07, -0.224486177E+00
0., 0.860106666E+07, -0.180297330E+02, 0., 0.104572655E+08, 0.286577225E+03
0., 0.118008018E+08, -0.243527045E+05, 0., 0.119761142E+08, 0.200319291E+06
0., 0.120018677E+08, -0.177347835E+06, 0., 0.125804003E+08, 0.111275201E+04
0., 0.000000000E+00, 0.000000000E+00, 0., 0.000000000E+00, 0.000000000E+00
-1BEGINCENDC 0.35258E-02 0.74318E-03 3 3 14 2 3
0.40944359E+01 0.80845419E+02 0.00000000E+00 0.10069636E-02 0.60000000E+02
0., 0.827674470E+03, 0.398806056E-01, 0., 0.130501996E+06, 0.508365787E+00
0., 0.252780509E+06, -0.280985689E+00, 0., 0.260749831E+06, 0.360866589E+00
0., 0.544371051E+06, -0.152645223E+01, 0., 0.696229069E+06, 0.773993647E+01
0., 0.768161125E+06, -0.566855648E+01, 0., 0.415043368E+07, -0.224486177E+00
0., 0.860106666E+07, -0.180297330E+02, 0., 0.104572655E+08, 0.286577225E+03
0., 0.118008018E+08, -0.243527045E+05, 0., 0.119761142E+08, 0.200319291E+06
0., 0.120018677E+08, -0.177347835E+06, 0., 0.125804003E+08, 0.111275201E+04
0., 0.000000000E+00, 0.000000000E+00, 0., 0.000000000E+00, 0.000000000E+00
0.57735026919E+00, 0., 0.70710678119E+00, 0., 0.40824829046E+00, 0.
0.57735026919E+00, 0., -0.70710678119E+00, 0., 0.40824829046E+00, 0.
0.57735026919E+00, 0., 0.00000000000E+00, 0., -0.81649658093E+00, 0.
0.57735026919E+00, 0., 0.70710678119E+00, 0., 0.40824829046E+00, 0.
0.57735026919E+00, 0., -0.70710678119E+00, 0., 0.40824829046E+00, 0.
0.57735026919E+00, 0., 0.00000000000E+00, 0., -0.81649658093E+00, 0.

```

1.28 Branch Cards for Pseudo-Nonlinear Resistance (Type-99 Element)

The true nonlinear $v-i$ characteristic of Section 1.32 has limited usage due to the required travel time separating such elements. It is because such a true nonlinear representation can not then be used for more than one phase of a 3-phase nonlinearity that the element now to be described was developed. The element to be described seems to generally be a good approximation to the true nonlinear characteristic, provided the user exercises caution in employing it.

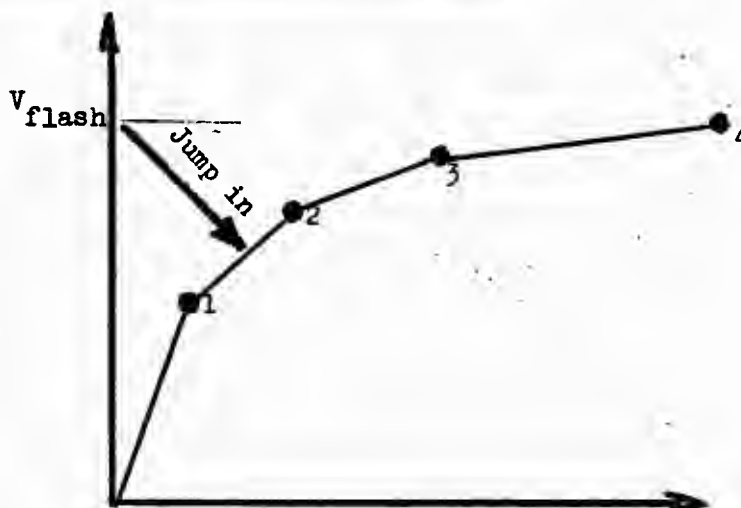

Fig. 1. Nonlinear $v-i$ characteristic, with flashover.

Conceptually, the idea is very simple. Since any segment of the piecewise-linear $v-i$ curve is a straight line (see Fig. 1), such a segment can be represented in the program by a resistor in parallel with the appropriate current source (see Fig. 2). The only problem is with limits, which of course are not observed by the linear representation of Fig. 2. We do not have a true (simultaneous) nonlinearity, and must rely on past history to tell us on what segment we should operate. In particular, the following points apply:

1. Upon flashover, there is no relevant history; the user must specify which segment he thinks it is appropriate to jump in on (see Fig. 1).
2. The user must use a small enough time step so that one moves up and down the nonlinearity slowly, smoothly. The program will only change segments after having illegally operated outside the range of the current segment for one time step, note (see Fig. 3).

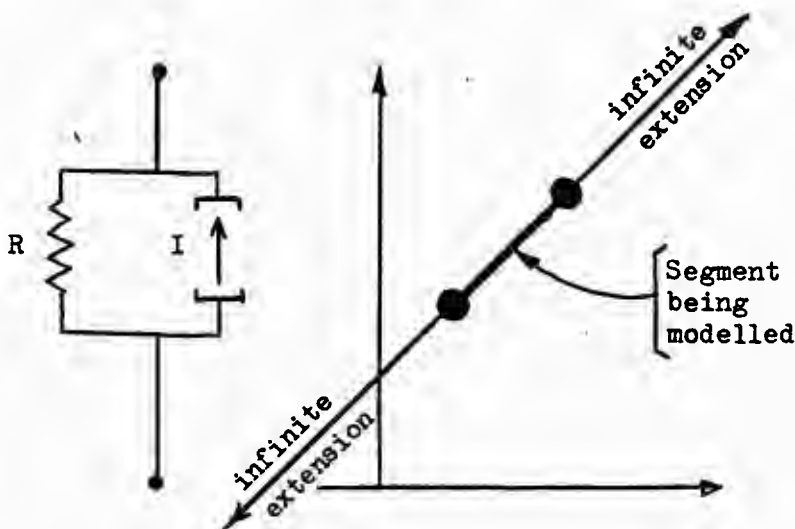

Fig. 2. Linear approximation used in program.

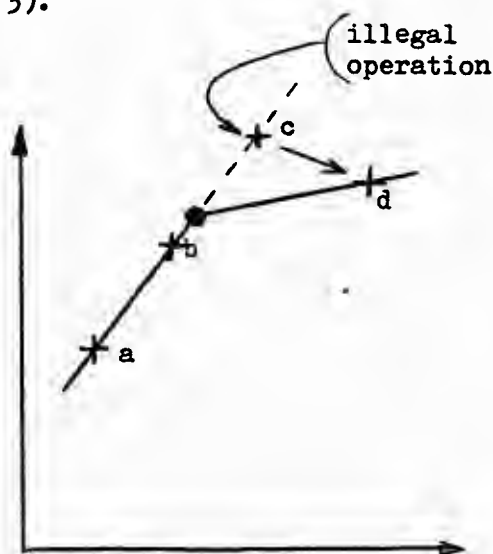
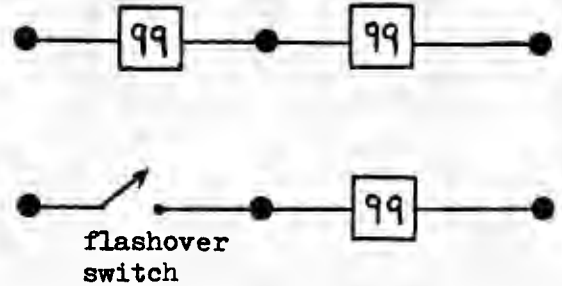

Fig. 3. Sample movement to a higher segment.

So as to avoid connectivity difficulties (see Section 1.3-D), the program automatically inserts a very-high-impedance resistive branch in parallel with a type-99 element, should no parallel branch exist as part of the user's data. This branch should have negligible effect on the answers, while sparing the user from the necessity of manually inserting such elements so as to provide the necessary connectivity.

The user must exercise care so as to always set up a physically-realistic problem. For example, the series connection of two type-99 elements is absurd, since mathematically there is no way to determine the voltage split between the two perfect gaps; the problem is not even defined. The same holds true of the series connection of a type-99 element and a flashover switch. Be nice to the program, and the program will be nice to you.



Rules for Data Input of type-99 element

- 1) Branch type is **99** (field ITYPE; columns 1-2).
- 2) Specify the terminal nodes by name (fields BUS1 and BUS2; columns 3-14). One node may be grounded, if desired (blank for node name).
- 3) If the v-i characteristic proper (exclusive of VFLASH, TDELAY, and JUMP) is identical with a preceding type-99 element, use the following storage saving option: Punch the node names of that preceding reference branch in fields BUS3 and BUS4 (columns 15-26), and omit the cards defining the v-i characteristic as mentioned in Point 8 below.
- 4) Field VFLASH specifies the breakdown voltage for the branch; until terminal voltage exceeds this figure in absolute value, a type-99 element is an open circuit. Such an open circuit is assumed for the steady state solution also.
- 5) The element will open up again after having been conducting when a current zero occurs (see illustration of Sect. 1.40), provided a time interval of TDELAY seconds has elapsed since the most recent firing (initiation of conduction as per Point 4). It is assumed that such a polarity change will occur only while operation is on segment 1 (that passing through the origin); if the polarity change occurs while operating on higher segments, a warning message of "TROUBLE" will be printed out (see Sect. 2.2b, Message 18).
- 6) Field JUMP gives the segment number that is to be jumped in on upon flashover. Segment L is, by definition, the one having point L (see Fig. 1 numbering) at its upper end, as shown in the sketch. A zero (or blank) field is automatically converted to a default value of unity.
- 7) Output options for printing and/or plotting use field IOUT in column 80:
 - 1-punch produces branch current
 - 2-punch produces branch voltage
 - 3-punch produces both branch current and branch voltage
 - 4-punch produces branch power and energy consumption (see Section 1.8)

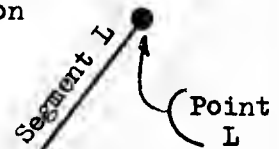

- 8) The v-i characteristic is defined point by point on cards which immediately follow the aforementioned branch card; these points are terminated by a 9999-card (punched in columns 13-16).
- a) The origin of the characteristic (i=0, v=0) is an implied point, which must not be inputted explicitly.
 - b) Current and voltage pairs of the break points are punched in fields CUR and VOLT, columns 1-32, one pair of values per card.
 - c) The order of input of points is as per Fig. 1, where both current and voltage values must be strictly monotone increasing. Thus segments with negative, zero, or infinite slope are not allowed.

No problem with spilling off the end of the curve exists, as the program assumes that the final two points define a segment which extends to infinity.

First Card Format

1	2	3	4	5	6	7	8	9	10	11	12	13	14	15	16	17	18	19	20	21	22	23	24	25	26	27	28	29	30	31	32	33	34	35	36	37	38	39	40	41	42	43	44	45	46	47	48	49	50	51	52	53	54	55	56	57	58	59	60
ITYPE	Node names				Reference br.				VFLASH	TDELAY	JUMP	VSEAL	IOUT																																														
	BUS1	BUS2	BUS3	BUS4																																																							
I2	AG	AG	AG	AG	E6.0	E6.0	IG	E6.0																																																			

Format for Points of V-I Characteristic

CUR	VOLT	9999
E16.0	E16.0	

Sample Data Listing

99	ALPHA	BETA	1.2E5	.065	3
		1.0	50000.		
		3.0	100000.		
		10.0	300000.		
		30.0	500000.		
		9999			
99	TESLA	ALPHA BETA	1.1E5		2

1.29 Branch Card for Pseudo-Nonlinear Reactor (Type-98 Element)

The true nonlinear flux-current characteristic of Section 1.33 has limited usage due to the required travel time which must separate such elements; it cannot, for example, be used in 3-phase configurations, which are the common cases of interest. Because of this restriction, the present pseudo-nonlinear reactor has been developed ---- an element which may be placed anywhere.

The pseudo-nonlinear reactor is the inductive analog of the pseudo-nonlinear resistance of Section 1.28, using a parallel connection of resistor and current source for internal representation (see sketch); resistance R changes only when operation moves from one segment of the characteristic to another, while the current source is updated at each time step. The qualification "pseudo" has been appended because operation moves from one segment to another only after having illegally operated outside the range of the present segment for one time step (Fig. 3, Sect. 1.28).

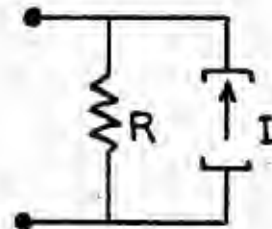
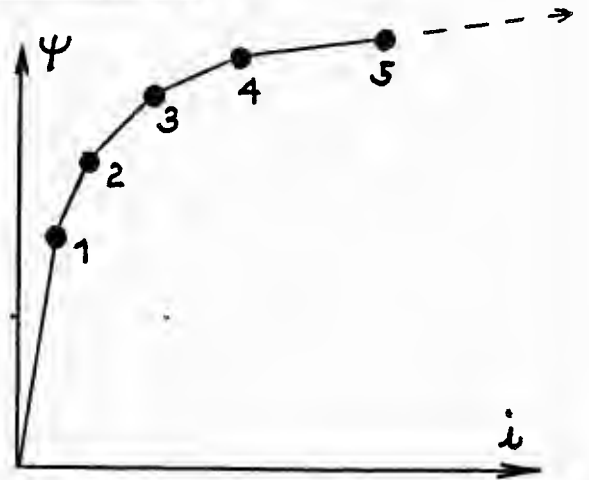
Rules for data input of type-98 element

- 1) Branch type is 98 (field ITYPE; columns 1-2).
- 2) Specify the terminal nodes by name (fields BUS1 and BUS2; columns 3-14). One node may be grounded, if desired (blank field for node name).
- 3) If the i - Ψ characteristic proper (exclusive of i_{steady} and Ψ_{steady}) is identical with a preceding type-98 element, use the following storage-saving option: Punch the node names of the preceding reference branch in fields BUS3 and BUS4 (columns 15-26), and omit the cards defining the i - Ψ characteristic as mentioned in Point 6 below.
- 4) Fields i_{steady} and Ψ_{steady} (columns 27-38) define the constant linear inductance to be used during the sinusoidal, phasor, steady-state solution. While only the ratio is actually required ($L = \Psi/i$), Ψ_{steady} is taken to be the limit on the linear region of operation; if initial flux exceeds this value, the T.P. prints out a warning message after the steady-state solution (see Sect. 2.2b, Message 15).
- 5) Output options for printing and/or plotting use field IOUT of column 80:
 - 1-punch produces branch current output
 - 2-punch produces branch voltage output
 - 3-punch produces both branch current and branch voltage
 - 4-punch produces branch power and energy consumption (see Sect. 1.8)

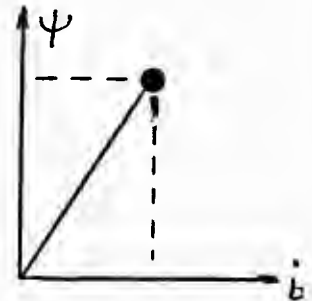

Caution concerning possible discontinuity at time zero

The user should always keep in mind that the sinusoidal steady-state phasor solution involves the linear magnetizing inductance given by $L = \psi_{\text{steady}} / i_{\text{steady}}$. Yet at the first time step, the EMTP shifts to using the user-defined nonlinear characteristic, at present always starting out on the first segment. If the initial-condition point does not lie on the characteristic, there will be a discontinuity which may produce a spurious transient immediately after time zero. Flux is always continuous, so the adjustment is accomplished by a horizontal jump having current discontinuity Δi , as per the sketch. If only one segment change is required as shown, this occurs in one time step. Hence a connected inductor of value L_s might well experience a corresponding voltage change of something on the order of $L_s \Delta i / \Delta t$, which may be substantial for small time steps (many per unit, in extreme cases). Present EMTP logic only allows one segment change per time step, so if the ultimate operating point really is on the K-th segment, K-1 time steps would be required to effect the total adjustment process, during which time a spurious transient of unpredictable shape might be observed.

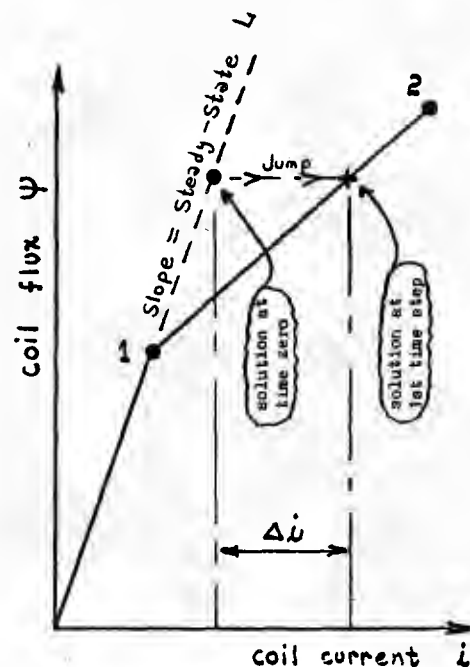

For balanced 3-phase initial conditions, the user can always shift his time reference (rotate the phase angles of all sinusoidal sources by some fixed phase angle) so that none of the three initial fluxes (or alternatively, currents) exceeds $\sqrt{3}/2 \approx .866$ times its peak value. In terms of figures which can be read from the phasor steady-state solution printout of branch flows, this corresponds to shifting the time origin so that current in one of the three components (for the 3-phase representation) is exactly zero at time zero.

The intelligent user will learn to always check the initial flux in type-98 pseudo-nonlinear inductors, and be wary of the aforementioned possible discontinuity. The initial flux in all data-case nonlinear or pseudo-nonlinear coils is printed out after the complete steady-state solution, and before the time-step-loop column headings, with a sample being:

INITIAL FLUX IN COIL 'JOHNDA' TO 'INTA' = E13.5

Assuming that the user has picked i_{steady} and ψ_{steady} equal to coordinates of the first point of the characteristic, then the aforementioned discontinuity trouble will be signaled by the following additional message:

WARNING. ASSUMPTION THAT AC STEADY STATE HAS FUNDAMENTAL FREQUENCY ONLY IS QUESTIONABLE WITH PRECEDING FLUX OUTSIDE LINEAR REGION.

Whenever the user sees such a message, he should be careful, and should study what the effect on the network solution will be; if possible, it is of course desirable to make legitimate alterations which cause all such messages to disappear.

TDELAY -----

- 1 \Rightarrow The first-step resistance value R_1 is assumed to be present for all time $t < 0$, as part of the sinusoidal phasor solution. Element time t_r and simulation time t are identical; field VFLASH is disabled.
- 0 \Rightarrow No such special fixed time delay (there may be delay due to positive VFLASH, though). Element is not connected for steady-state phasor solution.
- T_d \Rightarrow With $T_d > 0$, the element will never be connected until the simulation time t reaches this delay value. Positive VFLASH may provide added delay beyond this point, until such time as the branch voltage then exceeds the flashover value.

5) Output options for printing and/or plotting use field IOUT of column 80, as follows:

- 1-punch produces branch-current output;
- 2-punch produces branch-voltage output;
- 3-punch produces both branch-current and branch-voltage output;
- 4-punch produces branch-power and energy-consumption outputs
(see Section 1.8).

6) The $R(t)$ characteristic is defined point by point, on cards which immediately follow the aforementioned branch card; these points are terminated by a 9999-card (punched in columns 13-16).

- a) The beginning of the characteristic, at time $t_r = 0$, is the first point to be inputted.
- b) Time and resistance pairs defining each step of the staircase characteristic are punched in fields TIME and RESIS (columns 1-32), one pair of values per card.
- c) The order of input for points of the characteristic must be as per the numbering on the sketch, with time in seconds being monotone increasing. All resistance values must be positive, in units of [voltage/current] (ohms, if in MKS system).
- d) The last point is followed by the 9999-card.

TIME	RESIS
E16.0	E16.0

9999

1.31 Branch Card for Pseudo-Nonlinear Hysteretic Reactor

 (Type-96 Element)

The pseudo-nonlinear hysteretic inductor is very similar to the pseudo-nonlinear inductor described in section 1.29. The major difference is that this element allows the hysteretic behavior of the core material that will be represented. The element is represented internally by a resistor in parallel with the current source (see sketch at right). The resistance R is changed only when operation moves from one segment to another, whereas the value of the current source is updated at each time step. The qualification "pseudo" has been appended because operation moves from one segment to another only after having illegally operated outside the range of the present segment for one time step (Fig. 3, sect. 1.28).

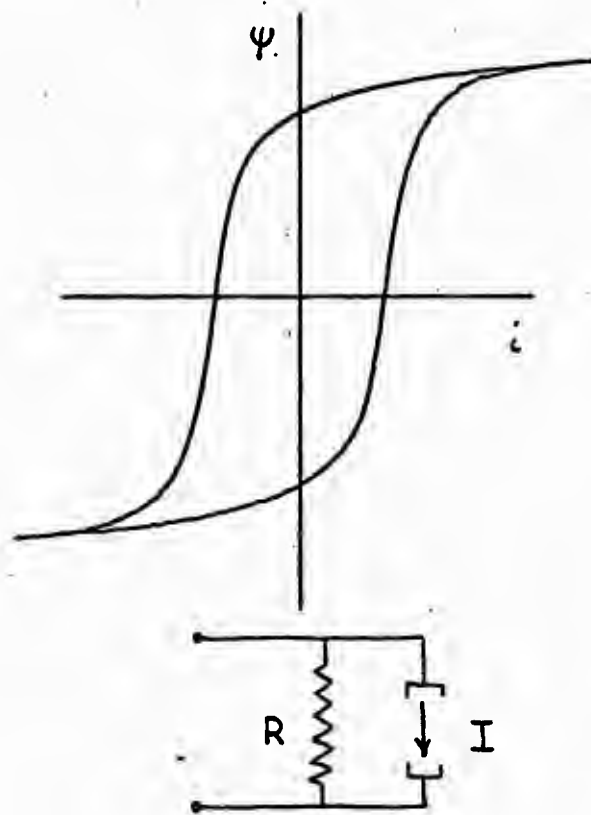

Rules for Data Input of Type-96 Element

- 1) Branch type is "96" (field ITYPE; columns 1-2).
- 2) Specify the terminal nodes by name (fields BUS1 and BUS2; columns 3-14). One node may be grounded, if desired (blank field for node name).

ITYPE	Node names				Reference br.				i steady	psi steady	psi res	...	IOUT
	BUS1	BUS2	BUS3	BUS4									
96	A6	A6	A6	A6	EG.2	EG.2	EG.2						

3) If the i-PSI characteristic proper (exclusive of i-steady, PSI-steady, and PSI-res) is identical with one of the preceding type-96 elements, use the following storage saving option: Punch the node names of the preceding reference branch in fields BUS3 and BUS4 (columns 15-26) and omit the cards defining the i-PSI characteristic as mentioned in point 6 below.

4) Fields i -steady and Ψ I-steady (columns 27-38) define the constant linear inductance that is to be used during the sinusoidal, phasor, steady-state solution. While only the ratio is actually required ($L = \Psi$ I-steady/ i -steady), Ψ I-steady is taken to be the limit on the linear region of operation; if initial flux exceeds this value, the EMTP prints out a warning message after the steady-state solution (see Sect. 2.2b, message 15). In addition, the point (i -steady, Ψ I-steady) must lie within the major hysteresis loop. If it does not, the EMTP will halt this run, providing an error message indicating this mistake.

The user also has the option of allowing the EMTP to calculate i -steady and Ψ I-steady itself. This option is chosen by specifying i -steady = 8888 and leaving Ψ I-steady blank. The EMTP chooses the steady-state point by the following method: first the trajectory from the origin to the positive saturation point is created, then the point on that trajectory, where the flux is equal to 70% of the saturation flux, is chosen as the steady-state point (see sketch).

5) Field Ψ I-res (columns 39-44) specifies the value of residual or remnant flux in the core. This will be used as the initial value of flux (Ψ I(0)) in the coil provided a non-zero flux value is not calculated for time zero by a sinusoidal, phasor, steady-state solution.

Therefore, if this type-96 element is not connected during a steady-state solution, the value of flux in the coil at time zero will be taken as the value specified in the field Ψ I-res. If this type-96 element is connected during a steady-state solution and only if the value of flux at time zero determined by the phasor solution is zero, the value of flux specified in the field Ψ I-res is used as the initial flux at time zero. (Note that if Ψ I-res = 0, the initial flux at time zero will be identical to that calculated by the phasor solution). Otherwise the initial flux in this type-96 element will be taken as the value calculated from the steady-state solution.

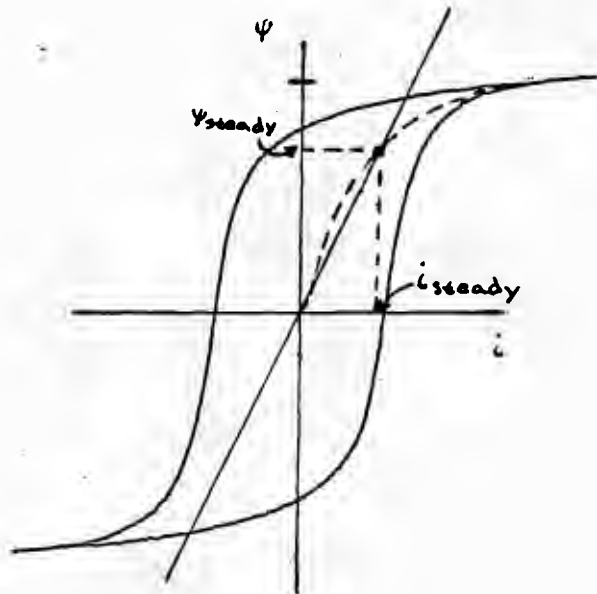
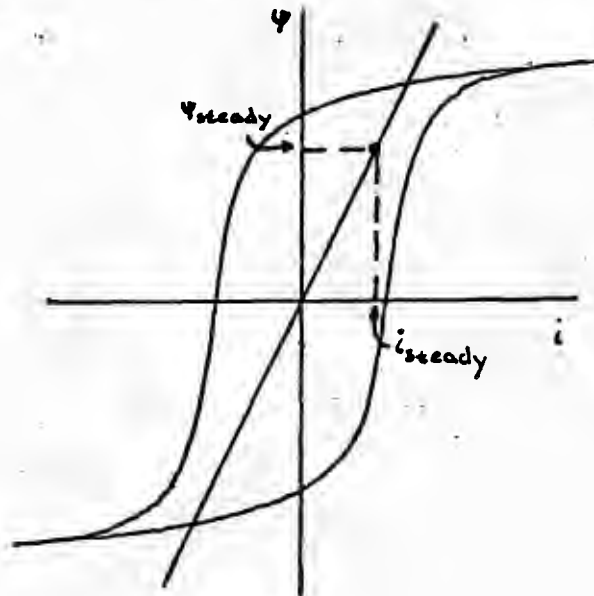

characteristic (which is then internally represented linearly at each time step). Herein lies a potential problem. If the initial point lies within the major loop, there is no problem; the operation simply begins at that point and proceeds from there as determined by the system. However if the initial point, as determined by a phasor solution, lies outside of the major loop, the problem arises because operation outside of the major hysteresis loop cannot occur in a real core. It happens here only because of the linear representation which is used in the steady-state solution. The EMTP will, therefore, move the initial point within the major loop (rather than terminating the run at this point, which is the only other option available). The scheme for moving the initial point into the major loop is as follows: draw a line of constant current through the initial point, determine the two points where it intersects the top and bottom half of the major loop (these will be the same points if $i(0)$ is greater than or equal to i -positive saturation or $i(0)$ is less than or equal to i -negative saturation) and take the average of these two points as the new initial point. Whenever this happens the following message is printed:

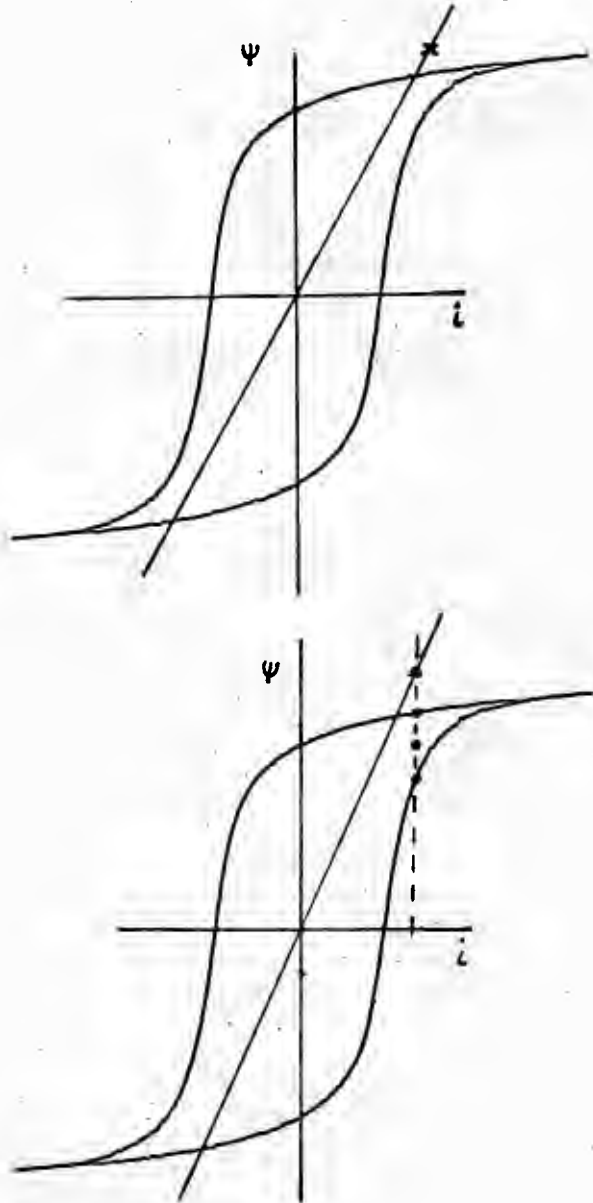

NOTE ---- NONLINEAR ELEMENT NUMBER 14 IS A TYPE-96 HYSTERETIC INDUCTOR WHICH IS CONNECTED BETWEEN BUSES 'A6' AND 'A6'. THE INITIAL FLUX-CURRENT POINT AS FOUND BY THE PHASOR STEADY-STATE SOLUTION HAS BEEN OBSERVED TO LIE OUTSIDE THE USER-DEFINED MAJOR HYSTERESIS LOOP, HOWEVER. THE INITIAL FLUX IS 14.4 AND THE INITIAL CURRENT IS 14.4. THE EMTP SHALL NOW ALTER THIS JUST-PRINTED FLUX SO AS TO MAKE IT LEGAL, WHILE HOLDING THE CURRENT CONSTANT. THE LINE OF CONSTANT CURRENT INTERSECTS THE USER-SUPPLIED MAJOR HYSTERESIS LOOP AT TWO POINTS (POSSIBLY EQUAL, IF THE CURRENT IS LARGE ENOUGH). THE 'UPPER' IS CUT AT FLUX VALUE 14.5, AND THE 'LOWER' AT FLUX VALUE 14.5. THE INITIAL FLUX SHALL BE TAKEN BY THE EMTP TO BE THE AVERAGE OF THESE, WHICH HAS FLUX VALUE 15.5.

If is the user's responsibility to determine if the change made is acceptable or not. It should be realized that transients due to sudden changes in flux (like those being made here) may die out very slowly. It is strongly suggested that the user make legitimate alterations which cause all such messages to disappear.

One potential cause for this type of problem could be a poor choice of i-steady and PSI-steady as discussed above. Consider the example in which a relatively low value of inductance (by method in point 1) was chosen to represent the loop during the phasor solution. Notice the required change in flux as discussed above. If point 2 is used as the steady-state point, rather than point 1, it is quite likely that no such problem with initial point outside of the major loop will occur. Any time the EMTP creates a new initial point whose flux coordinate is larger (in absolute value) than the initial point originally calculated from the phasor solution, one should check for the situation discussed in this example.

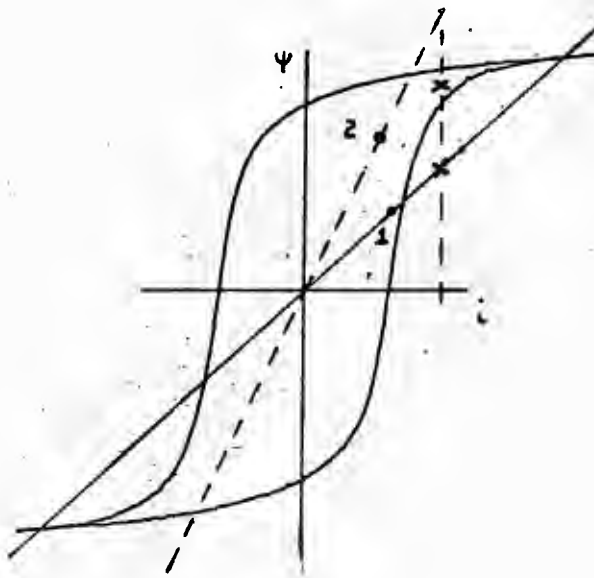

It should also be noted that for balanced 3-phase initial conditions, the user can always shift his time reference (rotate the phase angles of all sinusoidal sources by some fixed phase angle) so that none of the three initial fluxes exceeds $(\text{square-root of } 3)/2 = .866$ times its peak value. In terms of figures which can be read from the phasor steady-state solution printout of branch flows, this corresponds to shifting the time origin so that current in one of the three components (for 3-phase representation) is exactly zero at time zero.

If steps such as these do not eliminate problems of initial points outside of the major hysteresis loop, the user must decide if the changes made by EMTP are of small enough magnitude to be accepted or not.

The intelligent user will learn to always check the initial flux in each type-96 element in addition to checking for the message discussed above. The initial flux in all nonlinear or pseudo-nonlinear coils, is printed out after the complete steady-state solution, and before the time-step-loop column headings, with a sample being: INITIAL FLUX IN COIL 'NODEVA' TO 'NODEVB' = E13.5

By checking this, the user will be able to verify that he/she is correctly starting at a specified value of residual flux as desired. One will also be able to determine if the execution inadvertently begins at the user specified value of residual flux when, in fact, the user wants the initial flux to be calculated from a steady-state phasor solution.

It is anticipated that the user may have some difficulty obtaining the hysteresis characteristics required by the type-96 element. See Section 7.2a for EMTP's attempt at alleviating this difficulty.

1.32 MULTIPHASE ZnO SURGE ARRESTER MODEL

The model of this section provides for true (as opposed to pseudo) nonlinear representation of an arbitrary number of ZnO surge arresters. Theory has been documented in Ref. 22, Vol. 1 No. 2 (Dr. W. Scott Meyer) and No. 3 (Dr. Vladimir Brandwajn). The model is compensation-based, and Newton's method is used for iteration to the exact solution at each time step. While it is possible that no solution will so be found (in which case an EMT error message will result), if the case runs to completion, the answer is correct. Uncertainty associated with pseudo-nonlinear elements like the Type-99 resistor thus has been removed.

Nonlinearity for $q=30$

The basic constraint equation is resistive, and highly nonlinear:

$$i = p * (v / V_{ref})^{**q} \quad (1)$$

Typically one picks the reference voltage V_{ref} to be twice the rated voltage, or something close to it. In theory, the choice is arbitrary (it is an extra parameter). This then normalizes the equation, and prevents numerical overflow. Then constants "p" and "q" are unique characteristics of the device.

i/p	.0012	.0424	1.0	17.45
v/V_{ref}	0.8	0.9	1.0	1.1

237.4	2620	24201
1.2	1.3	1.4

As of November, 1983, the nonlinear V-I arrester characteristics can be approximated by an arbitrary number of exponential segments. Both gapped and gapless arresters can be represented. The gapped arrester requires the specification of two sets of exponential segments, while the gapless arrester requires only one.

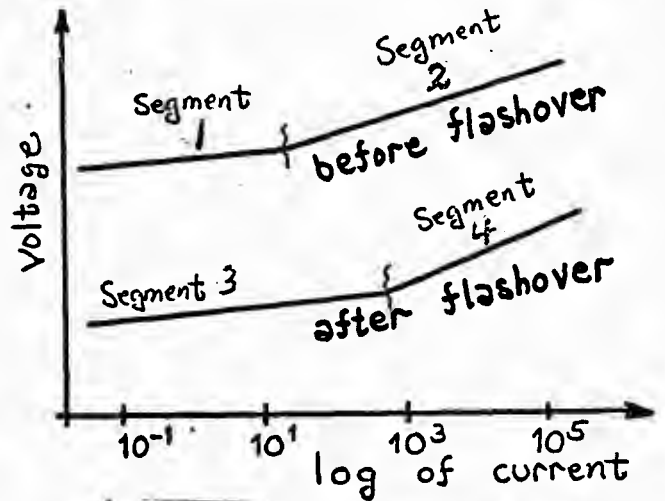

Due to the extreme nonlinearity of ZnO characteristics, very little current is drawn for voltages that are substantially below rated voltage V_{ref} (e.g., $0.5^{**30} = 9.E-10$). So as to avoid the possibility of exponentiation underflow, and also to speed the solution, a linear

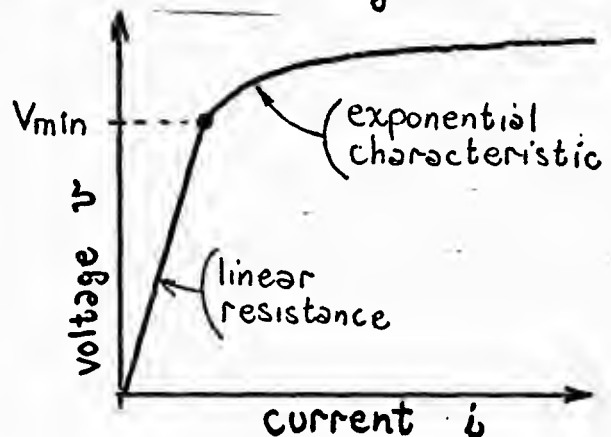

representation is actually used for low voltages (see sketch). But this is sort of hidden, and need not concern the user. In physical terms, the solution is unaffected by this usage (no ammeter could detect the difference).

Data cards for this component can be generated automatically by the support routine "ARRDAT" (mnemonically, "arrester data"). This is described in Section 7.2b, and is reached by key word "SATURATION" followed by key value $FREQ = 77$. Least mean square fitting is used. As of November 1983, there exists an additional support routine "ARRONT".

The use of multiphase compensation has some limitations which should be clearly understood. The most common application is for a 3-phase connection of arresters, using 3-phase compensation. The EMTP will normally be dimensioned to handle this (see Lists 24 and 26, Section 0.6). Such arresters are associated with a subnetwork which is then isolated (disconnected mathematically) from other such subnetworks by distributed-parameter transmission lines. As of November 1983, only the time-dep. and the piecewise nonlinear resistances can belong to a same subnetwork as the ZnO arresters. Thus, a subnetwork which uses the universal machine (U.M.; also compensation-based) can not involve the present ZnO arrester modeling, and vice-versa. In some cases a six-phase grouping of arresters can profitably be used, when both the high and the low sides of a 3-phase transformer bank are protected, and one does not want to worry about introducing stub lines to isolate the two sides (as described in Section 1.3). But the user should approach such larger groupings with caution, since the convergence of Newton's method may be adversely affected. It should be pointed out that the subnetwork identification is performed automatically by the program.

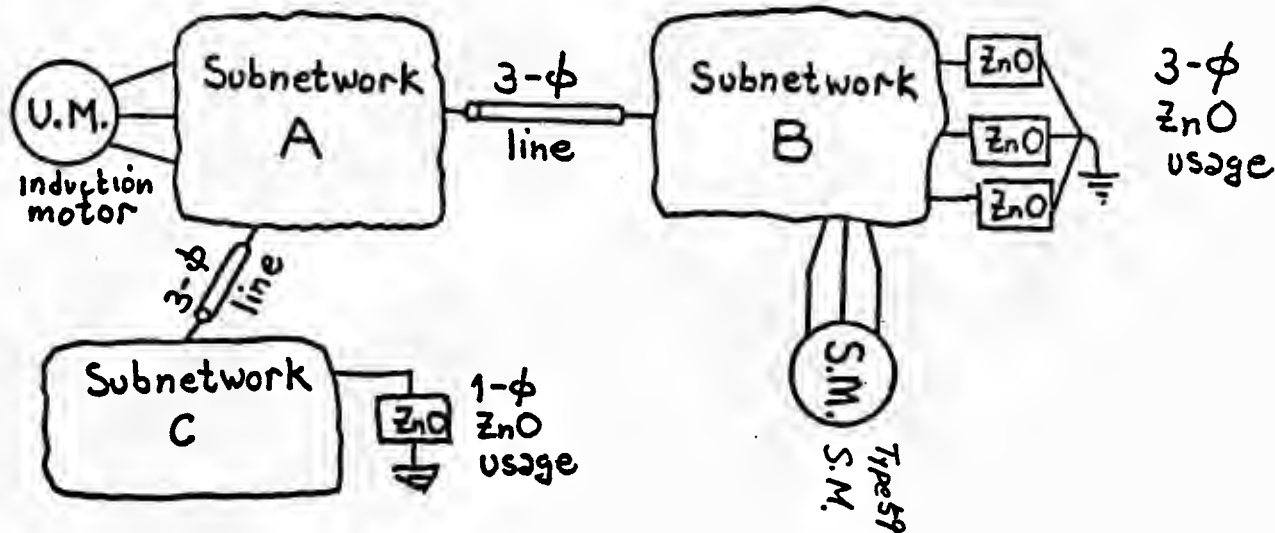

Finally, there is some application of the present model to silicon carbide (SiC) arresters, though serious (perhaps unacceptable) approximations must be made. No dynamics of the gap can be provided, unlike the sophisticated single-phase model of Section 1.34. Hence the possibilities of such usage shall not be emphasized here. Consult Vladimir's discussion in Vol. 1, No. 3 of the Newsletter for further details. In essence, one is representing the block very accurately ("two exponential segments appear to provide a very adequate fit"), and ignoring totally the dynamics of the gap (after flashover). But if one can not get data for the Type-94 representation of Section 1.34, maybe this is the best we can do for the time being.

E25.0	E25.0	E25.0
COEF	EXPON	VMIN

COEF --- Coefficient "p" of ZnO constraint Eqn. (1)
(1-25)

EXPON --- Exponent "q" of ZnO constraint Eqn. (1)
(26-50)

VMIN - - Minimum voltage for usage of the just-stated characteristic,
(51-75) in per unit based on VREF.

All such cards describing the exponential segments are to be in their natural order. Terminate each grouping with a "9999" card. If the arrester is equipped with a gap, the post-flashover data must follow that of the pre-flashover characteristic.

Control parameters of the ZnO iteration are specified via a special request word to be read in arbitrary order prior to the miscellaneous data cards. The request word "ZINC OXIDE" (or just "ZO", in abbreviated form) is used, with control parameters following to the right:

A 16	I 8	E 8.0	E 8.0	E 8.0	E 8.0	E 8.0
ZINC OXIDE	MAXZNO	EPSZNO	EPWARN	EPSTOP	ZNOLIM(1)	ZNOLIM(2)

MAXZNO --- Maximum number of Newton iterations which will be
(17-24) allowed for the solution of the surge arresters in each subnetwork. The Newton iteration will go this long unless tolerance EPSZNO is attained first.

EPSZNO --- Convergence tolerance for the Newton iteration. All
(25-32) voltage corrections of the coupled elements must be smaller than this in absolute value for the equations to be judged solved. A blank (zero) value is taken as a request for the value $\text{EPSILN} * V_{\text{ref}}$, where EPSILN is the familiar floating-point miscellaneous data parameter of Sect. 1.0h (1.E-8 for 60 and 64-bit versions like CDC, IBM, PRIME, VAX, SEL, Apollo).

EPWARN --- Voltage convergence tolerance for non-fatal warning
(33-40) message about a "sloppy solution." A blank (zero) data field is taken as a request for the value $V_{\text{ref}} / 1000$ -- representing one tenth of one percent of rated voltage, then, which is about the limit of graphical resolution.

EPSTOP --- Voltage convergence tolerance for a fatal error stop
(41-48) complaining about a non-converged iteration. A blank (zero) data field is taken as a request for the value $V_{\text{ref}} / 10$ -- or 10% of rated voltage. The current error in such a case could be astronomical, remember, due to the extreme nonlinearity (e.g., $1.1^{**26} = 11.9$).

ZNOLIM(1) --- The maximum per unit (based on VREF) voltage correction at each iteration step. A blank or zero is given the default value of 1.0 .
(49-56)

ZNOLIM(2) --- The maximum per unit (based on VREF) arrester voltage permitted during the iteration. A blank or zero is given the default value of 1.5 .
(57-64)

Or, rather than such a fixed-column specification, the user could employ format specification, with commas separating the data fields in question.

It might be noted that control of the maximum of voltage correction proved beneficial for the test case described in BENCHMARK DC-37. By limiting the per unit correction $DV/VREF$ to 0.9 using control parameter ZNOLIM(1), convergence during the initial massive shock was achieved in 6 iterations, rather than the original 9.

B. Use of Gaps for Practical Arrester Applications

The following material has been extracted from Vladimir's "User's Instructions for the EMT Representation of ZnO Surge Arresters," dated 8 April 1980 . This material was printed by Ontario Hydro, and provides insight into use of gap modeling.

At any point of time, the arrester is represented by a block with a variable conductivity (resistance). The value of this conductivity varies as the operating point of the arrester changes. The variation may be smooth or discontinuous. Consider, for example, an arrester equipped with a shunt, passive gap whown in Figure 2. Similar diagrams can be drawn for an arrester with a series passive gap, with the gap represented as a very high resistance.

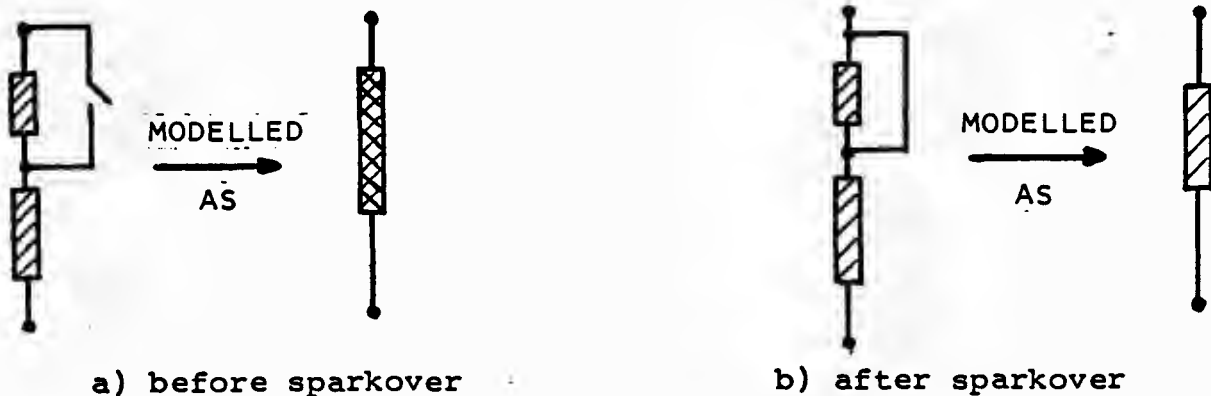

Figure 2. Representation of an arrester with a shunt gap.

Assume that two exponential segments are used to represent the arrester before and after gap sparkover. An idealized voltage-current characteristic of an arrester equipped with a shunt gap is shown in Fig. 3 . The numbers in circles correspond to the numbering sequence of the segments within the program. They also correspond to the data input order.

Consider, once more, an arrester equipped with a shunt gap. Its idealized voltage-current characteristic is shown in Figure 3. The numbers in circles correspond to the numbering sequence of the segments within the program. They also correspond to the data input order.

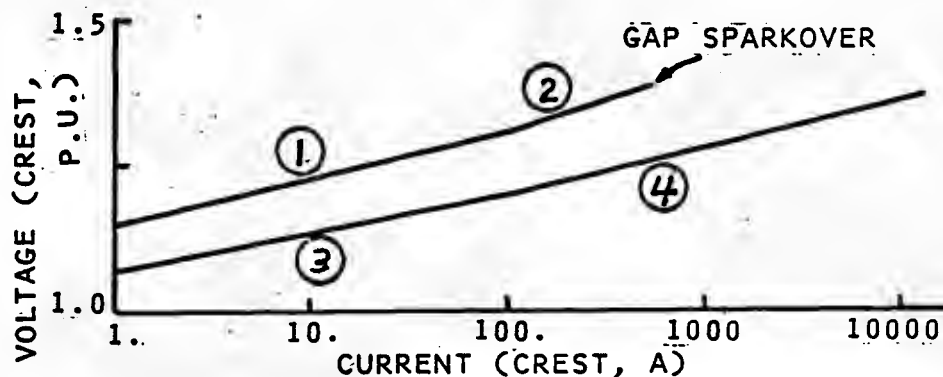

Figure 3. Protective characteristic of an arrester with a shunt gap.

The gap, when open, permits the flow of a very small leakage current. This behavior can be modelled by either a linear or nonlinear (exponential) resistor. Remember, a linear segment has an exponent $a = 1.0$.

Good results have been obtained with a linear resistor of $1.E8 - 1.E9$ ohm. Remember, the program uses admittance formulation and the gap characteristic is to be specified accordingly.

B.2 Remedies for problems with convergence

If one encounters convergence problem while using the ZNO model, three possible causes are:

- 1) The wrong arrester characteristic data set was used in the case.
- 2) The time step was too large.
- 3) Some spurious voltage oscillation occurred which can be taken care of by connecting the leakage capacitance or the bus capacitance in series with the chosen resistance, and then in parallel with the arrester. For further details of using this technique, please read the two articles written by Dr. Brandwajn and Dr. Alvarado in the February 1982 issue of the EMTP Newsletter (Volume 2, Number 3, pp. 10 - 32).

C. Sample ZnO Data Structures

As a first example, consider the gapless, single-phase example of issue No. 2, Vol. 1 of Ref. 22. The schematic is as shown at the right, with just a single exponential used to represent the ZnO arrester characteristic:

$p=2500$ amps $q=26$ $V_{ref}=778$ kV
A listing of the data case follows:

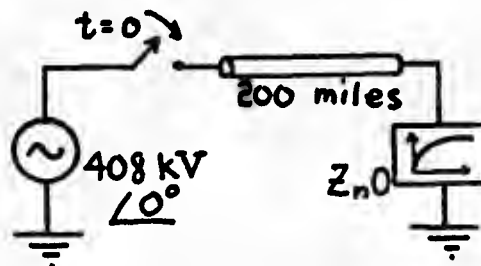

17f

```

BEGIN NEW DATA CASE
C   BENCHMARK DC-37
Z0,,,,,9,,
.000050 .020
      1      1      1      0      1      -1      0
      2      10     33      1      40     10     100     50
-1SEND REC .306 5.82 .012 200.
92REC      5555.
778000.    -100.
2500.      26.
              9999.
BLANK CARD ENDING BRANCH DATA.
BLANK CARD ENDING SWITCH DATA.
14SEND      408000.    60.
BLANK CARD ENDING SOURCE CARDS.
1
PRINTER PLOT
144 3. 0.0 20.      REC
194 4. 0.0 20.      REC
BLANK CARD ENDING PLOT CARDS.
BEGIN NEW DATA CASE

```

As for a 3-phase example, again consider the gapless, single-exponential case of issue No. 2 of Ref. 22:

```

-1SENDA RECA .305515.8187.01210 200. 0
-2SENDB RECB .031991.5559.01937 200. 0
-3SENDC RECC
92RECA      5555.
778000.    -100.
2500.      26.
              9999.
92RECB      RECA      5555.
92RECC      RECA      5555.
BLANK CARD ENDING BRANCH DATA.
BLANK CARD ENDING SWITCH DATA.
14SENDA      408000.    60.    0.0
14SENDB      408000.    60.    -120.
14SENDC      408000.    60.    120.
BLANK CARD ENDING SOURCE CARDS.
1
PRINTER PLOT
144 3. 0.0 20.      RECA
BLANK CARD ENDING PLOT CARDS.
BEGIN NEW DATA CASE

```

D. Singular Matrices

An aspect of the ZnO implementation which deserves comment is possible singularity of the equations being solved. The solution of each coupled arrester group is performed within "ZINCOX" using the general purpose linear equation solver "DGELG" which came with the SCE (Type-50) S.M. model (the model itself has been removed from the EMT since the fall of 1982). Pivoting is involved, along with miscellaneous data parameter "EPSILN" to measure possible singularity. Well, there has yet to be found a situation where this tolerance falsely caused trouble, when solutions were proceeding

normally. But it is not uncommon for there to be an EMTP error stop (KILL = 209, LSTAT(19) = 3501) if the iteration is diverging. Typically this is the result of excess voltage, which then is fed into the ZnO nonlinearity to produce astronomical currents; the elements of the Jacobian matrix thus are quite abnormal, and it is the singularity test of "DGELG" which terminates the simulation. BPA production users have had this problem in cases where ZnO protection of series capacitors was used, with a fault placed on the system in the phasor sinusoidal steady state solution for initial conditions (Ref. 8, Vol. X, Page MIOG-12, "Rule", 8 March 1980). To save others from the same fate, I reproduce that rule here:

RULE : THOU SHALL NOT BEGIN TRANSIENT SIMULATIONS INVOLVING NEW
ZnO SURGE ARRESTER MODELING WITH PHASOR SOLUTIONS WHICH
RESULT IN ABNORMAL ARRESTER VOLTAGES.

So, if a run is terminated due to a singular Jacobian, the user is advised to examine the voltages across the arrester at the time of difficulty, since this is the initial guess for Newton's method. Unless such voltages are reasonable physically, the iteration has little hope for convergence. Possibly the iteration limit would simply be reached, but more likely singularity of the Jacobian would be detected. The central of the Newton-Raphson iteration by means of ZNOLIM(1) might also be used to help the solution process.

1.3 COMMENTS ABOUT BRANCH CARDS FOR
NONLINEAR AND TIME-VARYING BRANCHES

A. Number and location of nonlinear and time-varying branches

- a) Network with only one such branch: No problem arises.
- b) Network with more such branches (see also reference 1 and c,d below)

The present solution method assumes that the network has only one nonlinear or time-varying branch within a topologically-connected region. In this respect, it is important to note that branches with distributed parameters do not connect their end nodes topologically (reason: the conditions at one end are seen at the other end not immediately, but only after the elapse of the travel time). Therefore, distributed parameter branches often break the network up into disconnected sub-networks. The solution method will work for more nonlinear or time-varying branches if these are "isolated," that is if each disconnected sub-network has not more than one nonlinear or time-varying branch. This condition can be checked as follows: In the original network graph erase all branches with distributed parameters and also all branches leading to nodes with known voltages (including ground). This will usually result in disconnected sub-networks. Each sub-network must have not more than one nonlinear or time-varying branch. This check is automatically made in the program; if the condition is not met, execution is stopped with the error-message NONLINEAR ELEMENTS AT 'NODE-1' AND 'NODE-2' WITHOUT TRAVEL TIME IN BETWEEN. JOB TERMINATED.

Hint for introducing disconnections: A lumped inductance L can be approximated by a lossless line of travel time $\tau = \Delta t$ and surge impedance $Z = \frac{L}{\Delta t}$. Since such a branch with distributed parameters is erased in the

connectivity check, it will help in further disconnecting the network. This approximation of a lumped inductance by a short, lossless line is known in the literature as "stub-line representation" (Barthold, L. O., and G. K. Carter, "Digital traveling-wave solutions," AIEE Trans., part III, vol. 80, p. 812, 1961). The stub-line representation must be used with caution; it works only if Z is large compared with the surge impedance of distributed lines (Thorén, H. B., and K. L. Carlsson, "A digital Computer program for the calculation of switching and lightning surges on power systems," IEEE Trans., vol. PAS-89, pp. 212-218, February 1970).

B. Singularity check

Every nonlinear or time-varying branch can have a characteristic with a region where $R = \infty$ (see Fig.1); therefore, the solution method must account for the eventuality that such a branch is blocked. This blocking might exclude a solution, which will show up mathematically in a matrix singularity. Fig. 2 shows such a case, where no solution exists whenever the nonlinear branch is blocked.

The program does not recognize whether a specific characteristic may or may not block. To make a case with a non-blocking characteristic solvable that would be unsolvable in the blocked state, it is necessary to split the nonlinear branch into two parallel branches--one linear and one nonlinear--, thus providing a branch of finite resistance. This is done by splitting the current in the nonlinear characteristic (see Fig. 3).

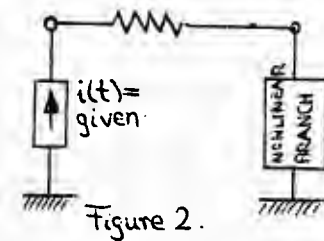
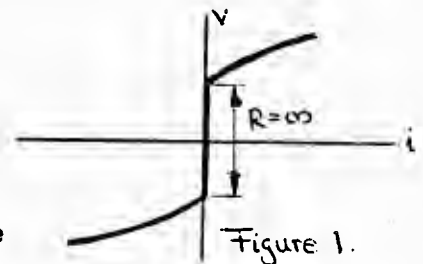

One branch with potentiality of blocking

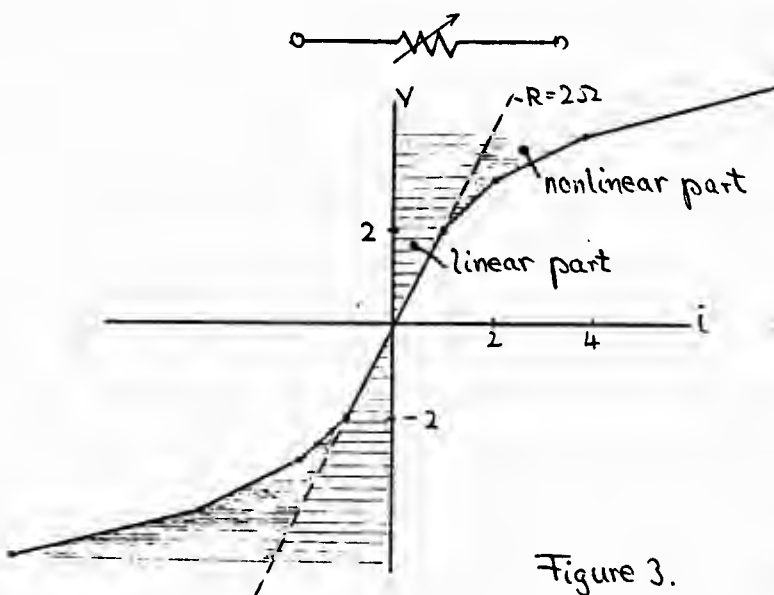

Two equivalent parallel branches

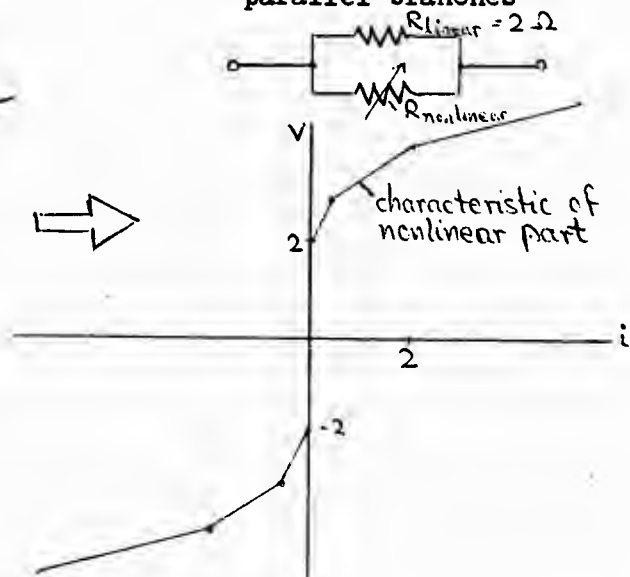

Figure 3.

C. Treatment in steady-state solution to set initial conditions

All nonlinear and time-varying resistances as well as lightning arresters are excluded from the network in the ac steady state solution. Nonlinear inductances are included with their linear region as specified on the branch card (see section 1.37).

Complication

Nonlinear and time-varying elements affect this requirement in that they must be ignored while making the aforementioned connectivity check. No such branch can be used as part of the paths satisfying the connectivity criterion.

Example

The network sketched at the right can not be solved by the Transients Program in the form shown. With switch S open as shown, ignoring of the time-varying element $R(t)$ leaves the right-hand switch node without a finite-resistance path to ground, and hence disconnected from the rest of the network. This problem would be rejected by the program (the solution process would break down, and the case would be terminated).

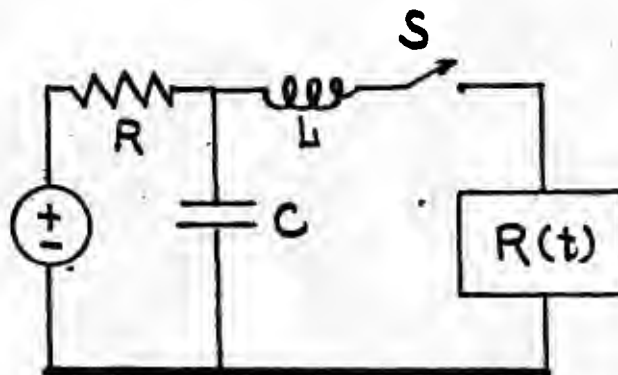

Remedy

One can provide required connectivity by inserting high-resistance paths where needed. By making such a resistance several orders of magnitude larger than other typical problem resistances, the transient solution is unaffected for engineering purposes. But be moderate in selecting such values. One can not in general use arbitrarily large values

it has been found. Due to the solution by superposition, one must not make these artificial resistances so large that they are lost in the roundoff of the equivalent diagonal conductances at the adjacent terminal nodes. In terms of floating-point miscellaneous data parameter "EPSILN", a resistance of $1.E-2 / \text{EPSILN}$ times other representative problem impedances might be reasonable.

5) Output options for printing and/or plotting are as usual (col. 80).

The second data card is to be punched with variable VSTART according to the following format:

1	2	3	4	5	6	7	8	9	10	11	12	13	14	15	16	17	18	19	20	21	22	23	24	25
VSTART																								
E25.0																								

VSTART --- Breakdown voltage in V (volts). The time count t_R starts as soon as v is $>$ or $=$ VSTART. This value cannot be left unspecified (blank field) or set to zero. To start the time count at the start of the transient study, set VSTART to a small value, e.g., VSTART = .01 V.

Next come cards which specify the time-varying characteristic point-by-point from left to right with one card for each pair of values $t_R, R(t_R)$. The format is:

1	2	3	4	5	6	7	8	9	10	11	12	13	14	15	16	17	18	19	20	21	22	23	24	25	26	27	28	29	30	31	32	33	34	35	36	37	38	39	40	41	42	43	44	45	46	47	48	49	50
R(t_R) in Ω										t _R in sec																																							
E25.0										E25.0																																							

Terminate the grouping of these data cards with a card having 9999 punched in columns 22-25.

Control parameters of the Newton-Raphson iteration are specified via a special request word, to be read in arbitrary order prior to the miscellaneous data cards. For details, see Section 1.32A .

Sample Data Listing

1	2	3	4	5	6	7	8	9	10	11	12	13	14	15	16	17	18	19	20	21	22	23	24	25	26	27	28	29	30	31	32	33	34	35	36	37	38	39	40	41	42	43	44	45	46	47	48	49	50
%I LEFT										RIGHT																																							
										300000.0																																							
										300.										0.0																													
										200.										0.3																													
										150.										0.6																													
										150.										1000.																													
										9999																																							

1.36 MULTIPHASE PIECEWISE LINEAR RESISTANCE WITH FLASHOVER

The model of this section provides for true (as opposed to pseudo) nonlinear representation of an arbitrary number of piecewise linear resistances. The model is compensation-based (see Section 1.32 for more explanations), and Newton's method is used for iteration to the exact solution at each time step. While it is possible that no solution will be found (in which case an EMTP error message will result), if the case runs to completion, the answer is correct. Uncertainty associated with pseudo-nonlinear elements like the type-99 resistor or isolating stub lines, thus has been removed.

The nonlinear resistance $R(i)$ in series with a linear resistance $RLIN$ is specified point-by-point. Linear interpolation is used between the data points.

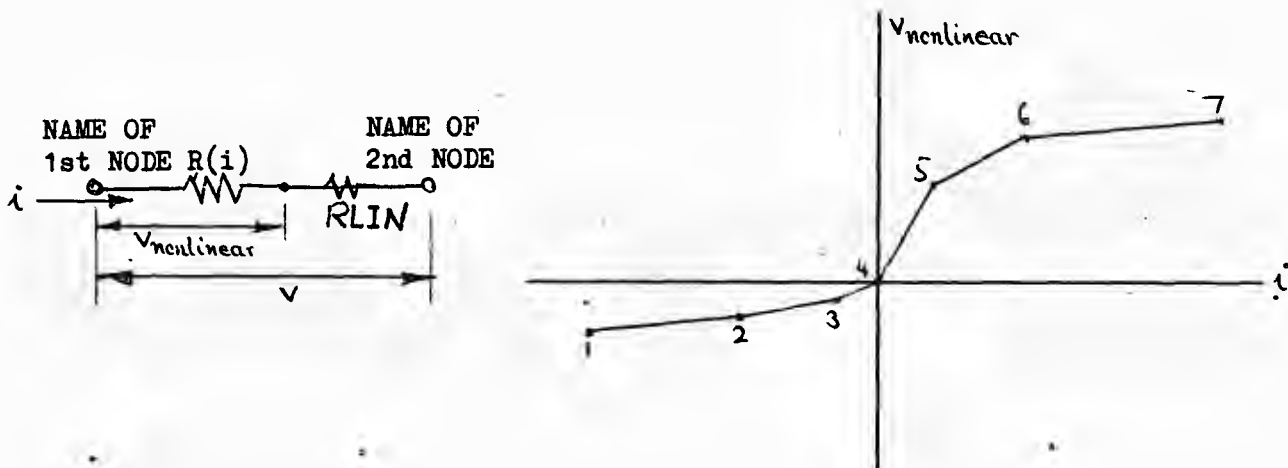
A. Applications:

- (1) Old Style
Lightning arrester:

R will be assumed infinite until $\text{abs}(V)$ is $>$ or $= VFLASH$; thereafter, $R = R(i) + RLIN$ according to specified nonlinear characteristic. The linear resistance $RLIN$ can be used to represent the grounding resistance of the lightning arrester; a value of zero is permissible, if desired.

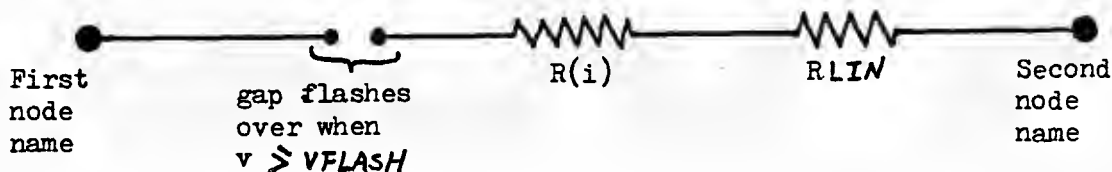

The user can choose between the following two options:

- a) No clearing after the sparkover (discharge), i.e., the gap remains shorted once it has fired.
- b) Clearing after the sparkover, i.e., following a discharge, the gap will open (clear) at the next current zero crossing.

- (2) Nonlinear resistance,
Modern gapless arrester:

The gap is omitted by setting $VFLASH <$ or $= 0.0$. $RLIN = 0.0$ if all resistance is in the piecewise-linear characteristic.

Next come cards which specify the nonlinear characteristic point by point from left to right with one card for each pair of values i , $V_{\text{nonlinear}}$. The format is:

E25.0	E25.0
CUR	VOLT

Terminate the grouping of these data cards with a card having 9999 punched in columns 22-25.

If the characteristic is symmetrical with respect to the origin, the following storage saving option can be used: Specify only the positive part of the characteristic (above the origin). Do not specify the origin (0.0, 0.0) which will be generated automatically by the module "NONLN2" of overlay 2.

Control parameters of the Newton-Raphson iteration are specified via a special request word, to be read in arbitrary order prior to the miscellaneous data cards. For details, see Section 1.32A or 1.0g17 ("ZINC OXIDE" request).

C. Sample Data Usage

C 345678901234567890123456789012345678901234567890123456789012345
92HOMA 4444.

0.0	600000.	0.0
-10000.	-600000.	
-4200.	-500000.	
-1630.	-400000.	
-630.	-300000.	
-200.	-200000.	
-50.	-100000.	
50.	100000.	
200.	200000.	
630.	300000.	
1630.	400000.	
4200.	500000.	
10000.	600000.	
9999.		

VFLASH = 600000.
NFLASH = 0

VZERO = 0.0
RLIN = 0.0

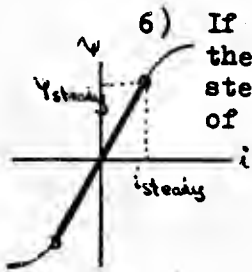

6) If the transient is started from a non-zero ac steady state condition, then the linear region of the nonlinear inductance will be used in the steady state solution. This linear region must be specified as a pair of values i_{steady} , ψ_{steady} . Special cases:

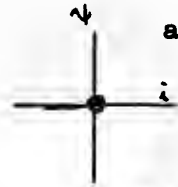

a) $i_{\text{steady}} = 0$ or blank } To be used if no ac
 $\psi_{\text{steady}} = 0$ or blank } steady state solution
 is asked for or if non-
 linear inductances are to be totally ignored
 during the steady-state solution.

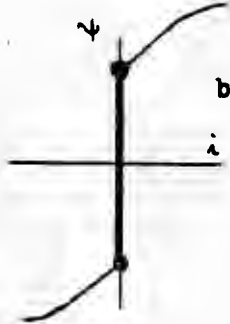

b) $i_{\text{steady}} = 0$ or blank } Nonlinear inductance
 $\psi_{\text{steady}} > 0$ } will be non-conducting
 in steady state solution,
 but will, in general, have a non-zero initial
 flux (is computed automatically).



c) $i_{\text{steady}} > 0$ } Is not permitted (would
 $\psi_{\text{steady}} = 0$ } be a short-circuit in
 steady state). This case
 leads to the following error message: "NO
 INTERSECTION WITH NONLINEAR CHARACTERISTIC NO. []".

The linear region to be used in the ac steady state solution is defined by the slope $L = \psi_{\text{steady}} / i_{\text{steady}}$. The initial flux $\psi(0)$ will be listed in the output. If the solution leads to a flux $|\psi(0)| > |\psi_{\text{steady}}|$, then the following warning is printed: "*** WARNING. ASSUMPTION THAT AC STEADY STATE HAS FUNDAMENTAL FREQUENCY ONLY IS QUESTIONABLE WITH PRECEDING FLUX OUTSIDE LINEAR REGION."

1.38 TYPE-94 MODERN-STYLE SiC SURGE ARRESTER COMPONENTHistory of Development

The EMTP branch component which has type-code 94 is a single-phase true nonlinear element whose dynamics are designed to represent a modern-style silicon-carbide surge arrester with current limiting gap.

The mathematics of the Type-94 model are fully documented in Reference 17. It is strongly recommended that a copy of this paper be procured from the library by anyone who is considering the use of this component. Details are too involved to be fully covered here.

The computer implementation of the Reference 17 mathematics was performed at the American Electric Power (AEP) Service Corporation in New York City. Dr. Arun Phadke, Chuck Wolf, and perhaps others of that organization remain (as of July 1977) the only persons who have any practical experience with the arrester model. Procurement of the seventeen data parameters is a complication, with the only known measurements to date being applicable to the 765-kV arresters which are used by AEP.

Details related to the acquisition and testing of this AEP surge arrester code are summarized in Reference 8 (Vol. VII, 15-page memorandum dated February 10, 1977). This memo is recommended reading for the uninitiated, too. Highlights include a fully-documented sample simulation, plus five pages of comments by Arun.

EMTP Data Format for Type-94 Arrester Component

Data input for a Type-94 surge arrester component begins with the usual branch card, which is to be punched according to the following format:

ITYPE	Node names		Reference br.		V _{flash}	F _v	F ₁	...	IOUT
I2	A6	A6	A6	A6	E6.2	E6.2	E6.2		I1

ITYPE ----- Branch type-code "94" is to be punched in columns 1-2 of the card, as a request for the arrester component.

BUS1 } ----- EMTP node names for the two ends of the branch. These
 BUS2 } are two pieces of 6-character alphanumeric information, to be punched in columns 3-14.

BUS3 } ----- Columns 15-26 are used only for the reference branch feature,
 BUS4 } for the second or later arrester of a set of arresters which have identical characteristics. If the present arrester is identical to a preceding arrester, the user can punch the node names of that preceding arrester (as an ordered pair) in the data fields BUS3 and BUS4. As illustrated by the sample data listing below, parameters V_{flash}, F_v, and F₁ are not considered to be part of this check for "identical" characteristics; these three

floating-point parameters must always be punched, and can take on any values, irrespective of whether the reference-branch procedure is used.

V_{flash} — Arrester flashover (sparkover) voltage, in units of voltage (whatever they may be, for the problem under consideration).

$\left. \begin{matrix} F_v \\ F_i \end{matrix} \right\}$ — Voltage and current scaling factors (respectively), which allow the same arrester constants to be used without alteration in data cases for which base voltage and current may be different. By definition (see note below):

$$V_{system} = F_v \cdot V_{arrester}$$

$$I_{system} = F_i \cdot I_{arrester}$$

IOUT — A nonzero punch in column 80 requests output of the following arrester variables:

- punch "1" for branch current;
- punch "2" for branch voltage;
- punch "3" for both branch current and branch voltage;
- punch "4" for both branch power and energy consumption.

Provided (i.e., if and only if) fields "BUS3" and "BUS4" are blank, six additional cards bearing 18 parameters of the arrester must immediately follow the branch card above. The format and meaning are as follows

E16.0	E16.0	E16.0	E16.0		
K of (2)	b of (2)	u_b of (1)		Read, but unused, at present	Card 1
K_c of (9)	I_c of (9)	E_1 of (10)			Card 2
K_r of (12)	K_o of (12)	K_1 of (12)			Card 3
K_2 of (12)	W_2 of (16)	K_d of (17)			Card 4
W_o of (18)	W_1 of (18)	K'_o of (24)			Card 5
K_3 of (24)	I_3 of (22)				Card 6

The meaning of these parameters is documented in the aforementioned IEEE paper (Ref. 17), portions of which have been reproduced below. It is hoped that the symbol references above are clear. For example, the expression "K of (2)" which is in the first field of the first card means that this data field (columns 1-16) is to be punched with parameter "K" of Eqn. (2) of the IEEE paper. Etc. for the other references.

Simulation of Dynamic Arrester Performance

The block characteristics of Figure 1 suggest a simple equivalent circuit would include a nonlinear resistor in series with an inductance and shunting diode, the latter to give the common return characteristic.

Since the gap dynamic characteristics were so dominant, the diode was not represented in this study. For the equivalent circuit we may thus write

$$V_b = R_b i_a + L_b \frac{di_a}{dt} \tag{1}$$

In this equation, R_b is not a constant. For our purpose we may write

$$R_b i_a = K i_a^b \quad (2)$$

Where K and b are constant over a given range of currents, but may vary from one range to another.

During the period immediately following sparkover, $t_0 < t < t_1$, the gap voltage increases rapidly as the arc is lengthened. The development of this arc voltage resembles the charging of a capacitor, therefore the relationship chosen to represent this phenomena has form

$$v_g = \int_{t_0}^t \frac{i_a}{C} dt \quad t_0 < t \leq t_1 \quad (8)$$

It was found that the capacitance C for this type of representation is itself a function of arrester current and time such that

$$\frac{1}{C} = K_c \int_{t_0}^t i_a' dt \quad \begin{aligned} i_a' &= i_a, & i_a < I_c \\ i_a' &= I_c, & i_a \geq I_c \end{aligned} \quad (9)$$

where K_c and I_c are constant for a given gap design. Therefore the capacitance is infinite at sparkover and monotonically decreases according to equation (9). If R_r and R_d of Figure 5 are assumed infinite during this first interval of time, then the expression for C given by equation (9) is the same C shown in the equivalent circuit diagram. The final time t_1 for this first interval occurs when the gap voltage reaches a level E_1 , which is a constant for a given gap design and a specified arrester rating, thus t_1 is defined by

$$v_g(t_1) = E_1 \quad (10)$$

During the second stage of gap response, $t_1 < t < t_2$, the arc voltage exhibits a form of negative resistance in that it remains relatively constant at E_1 for high current levels but increases somewhat as the current decreases. This phenomenon is represented by the equation

$$v_g = K_r \int_{t_1}^t \frac{K_o - v_g}{K_1 + K_2 i_a} dt + v_g(t_1) \quad t_1 < t \leq t_2 \quad (11)$$

which may be written in the differential form

$$\frac{1}{K_r} \frac{dv_g}{dt} = \frac{K_o - v_g}{K_1 + K_2 i_a} \quad t_1 < t \leq t_2 \quad (12)$$

where K_r , K_o , K_1 , and K_2 are constant for a specified arrester. If R_r in Figure 5 is assumed infinite during this second interval of time, the equivalent circuit may be related to equation (12) by letting

$$E_r = K_o - K_1 i_a - K_2 i_a^2 \quad (13)$$

$$R_r = K_1 + K_2 i_a \quad (14)$$

$$C = \frac{1}{K_r} \quad (15)$$

The final time t_2 for the negative resistance period occurs when a critical level of thermal energy W_2 is reached so that t_2 is defined by

$$\int_{t_1}^{t_2} v_g i_a dt = W_2 \quad (16)$$

During the thermal decay period, $t_2 < t < t_3$, the gap voltage tends to decrease as the arc heats the arc chamber walls. This effect is represented by adding a negative energy-dependent term to the integrand in equation (11), that is

$$v_g = K_r \int_{t_2}^t \left[\frac{K_o - v_g}{K_1 + K_2 i_a} + \frac{W}{K_r} (K_d - v_g) \right] dt + v_g(t_2) \quad t_2 < t \leq t_3 \quad (17)$$

where K_d is a constant and the thermal energy factor is given by

$$W = W_o + W_1 \int_{t_1}^t v_g i_a dt \quad (18)$$

where W_o and W_1 are constant. Equation (17) may also be written in the differential form

$$\frac{1}{K_r} \frac{dv_g}{dt} = \frac{K_o - v_g}{K_1 + K_2 i_a} + \frac{W}{K_r} (K_d - v_g) \quad t_2 < t \leq t_3 \quad (19)$$

The equivalent circuit for the gap given in Figure 5 is therefore defined over this interval by equations (13) - (15) and the relationships

$$E_d = K_d \quad (20)$$

$$R_d = \frac{K_r}{W} \quad (21)$$

The final time t_3 for the thermal decay period occurs when the arrester current decreases to a very low level, a region of arc instability. Therefore, t_3 is defined by

$$i_a(t_3) = I_3 \quad (22)$$

$$\frac{di_a}{dt}(t_3) < 0 \quad (23)$$

The region occurs immediately prior to the arrester interruption time t_4 . During this interval, $t_3 < t < t_4$, the gap voltage rises rapidly. This phenomenon causes the current to decrease at a much greater rate which speeds up the desired interruption. The arc instability may be simulated by modification of equation (11), that is instability

$$v_g = K_r \int_{t_3}^t \frac{K_o - v_g}{K_1 + K_3 i_a^2} dt + v_g(t_3) \quad t_3 < t \leq t_4 \quad (24)$$

In order to decipher these equations, go get a complete copy of this IEEE paper (Ref. 17)!

As an illustration of Type-94 EMTF surge arrester data, consider the following usage. This is taken from UTPF Test Case #57, the solution of which is fully documented in the EMTF memo of February 10, 1977.

94	N11		8.5	1.0	1.0				
		5.8		.27		.0001			
		1.4E8		.268		5.0			
		10000.		7.0		2.0			
		.02		.0806		4.5			
		200.		4.0E6		10.			
		4000.		.05					
-1	81	83		.658	27.8	5.	0		
-1	93	82	81	83					
		AB2		1.E-8					
94	AB2		N11	25.5	3.0	2.0			
	N0	N1	-1.			1000.			
	B0	B1	-1.			1000.			
14	30	30.	60.						-1.

Two identical surge arresters (except for flashover voltage and scaling factors) are being defined here. The first, which is connected between node " N11" and ground has flashover voltage equal to 8.5 (in whatever units are being used; kV ?) and scaling factors of unity; there is no reference-branch usage (all parameters of the arrester are supplied with it). The second arrester connects node " B2" to ground, and is a copy of the first (the reference-branch procedure is used). Flashover voltage for this 2nd arrester is 25.5 , and voltage and current scaling factors are 3.0 and 2.0 , respectively, note.

The following explanation of voltage and current scaling factors F_v and F_i was taken from the EMTF memorandum dated February 10, 1977:

Since the constants are usually derived from a prorated arrester module, they correspond to a physical description of the module. Typically, one would calculate the constants to describe the kiloamperes - kilovolts relationship for the arrester module. The usual EMTF representation of a power system is in some per unit system. Rarely would the power system be modeled on the physical voltage - current scales of a prorated arrester module. It is therefore necessary to effect a scale change before the arrester model can be directly used in the EMTF.

The necessary scale changes are implemented through the voltage and current scale factors F_v and F_i entered on each Type 94 card:

$$V_{\text{system}} = F_v \cdot V_{\text{arrester}}$$

$$I_{\text{system}} = F_i \cdot I_{\text{arrester}}$$

Consider the two simulations in the test case as examples of the use of F_v , F_i . In both simulations, the arrester module used is the same, so that the constants of the arrester model also are the same. The current base for the first system (buses $N_1 - N_{11}$) is 1 KA. V_{flash} for the arrester moduel is 8.5 KV. Since it is desired to simulate the discharging of a line energized to 10 KV through this arrester module, F_v and F_i are both set equal to 1.0 and a generator voltage of 10 is used.

Now consider the second system operating at 30 KV (Generator voltage = 30) with a base current of 2 KA. A line similar (though not identical) to the one of the previous simulation is connected between buses B1 and B2. Flashover voltage for the arrester is set at 25.5. The flashover voltage of a single module is 8.5 KV, so that the voltage and current conversion factors must be set at $F_v=3.0$ and $F_i=2.0$. Note that this selection closely parallels the actual test of this nature, which would require a series connection of three arrester modules each with a flashover voltage of 8.5 KV. The voltage and current waveforms from EMTP output are expressed in system variables, consequently although all the voltages and currents for the two cases are approximately similar to each other, the voltage and current scales for the two cases differ by a factor of 3 and 2 respectively.

The familiar EMTP requirement of isolating true nonlinear elements by distributed-parameter lines also applies to the Type-94 AEP surge-arrester component. Refer to Section 1.3-A-a of the present EMTP User's Manual. Later extension to a 3-phase component seems inevitable, if there is sufficient interest on the part of users (see Section III-E of the EMTP memo dated May 15, 1976 --- Vol. V of Ref. 8).

Storage requirements for the Type-94 surge arrester component are easily calculated. First, each arrester contributes one entry to EMTP List number 9 (the nonlinear element table). The contribution from each arrester to List number 10 (points defining nonlinear characteristics) depends upon whether the reference branch procedure is used; 11 cells are required if it is, while 18 cells are required if it is not.

The reader is advised not to confuse silicon-carbide (SiC) arresters ---- for which the present Type-94 nonlinear element was designed ---- with the newer zinc-oxide arresters. As of July 1977, the latter are still believed to be somewhat experimental, and are the subject of ongoing development. Zinc-oxide arresters are radically different in that they have no flashover gap; the nonlinear element is extremely nonlinear, and is simply permanently connected to the system (drawing a leakage current in the steady-state). At present, the only EMTP modeling which has been designed especially for zinc-oxide arresters is the Type-17 EMTP source component (see Section 1.6).

The Type-94 surge arrester component is of course an open circuit during the steady-state phasor solution for initial conditions. Then, should a flashover occur at some particular time during the simulation, a message is printed. The following is an example, taken from UTPF Test Case #57:

```
ARRESTER * AB2* TO * * FLASHOVER AT TIME .32750E-02 SEC.
```

Finally, when the arrester seals again (becomes an open circuit once again), a second message is printed, such as:

```
ARRESTER * AB2* TO * * CLEARED AT TIME .27050E-02 SEC.
PER UNIT ENERGY DISSIPATED = .983621E-02
```

Note that the dissipated energy is also printed. This is in per unit, and is just the energy which has been absorbed since the last firing. This figure is totally independent of that which comes from a "4"-punch in column number 80 of the branch card for the arrester ---- for which physical units are used, and with the energy accumulation beginning at time zero.

The term "per unit" which is used for arrester energy printout is based on the user-supplied scaling factors F_v for voltage and F_i for current (columns 33-44. of first data card for arrester). One can convert between absolute energy and per unit energy using the following definition:

$$P \text{ [absolute]} = F_v \cdot F_i \cdot P \text{ [per unit]}$$

If the user specifies source amplitudes to be in volts and amps, then the unit of absolute energy is the Joule ; but if kV were used for the units of source voltage (as in UTPF Test Case #57 illustrated in this section), then the unit of absolute power is the megaJoule .

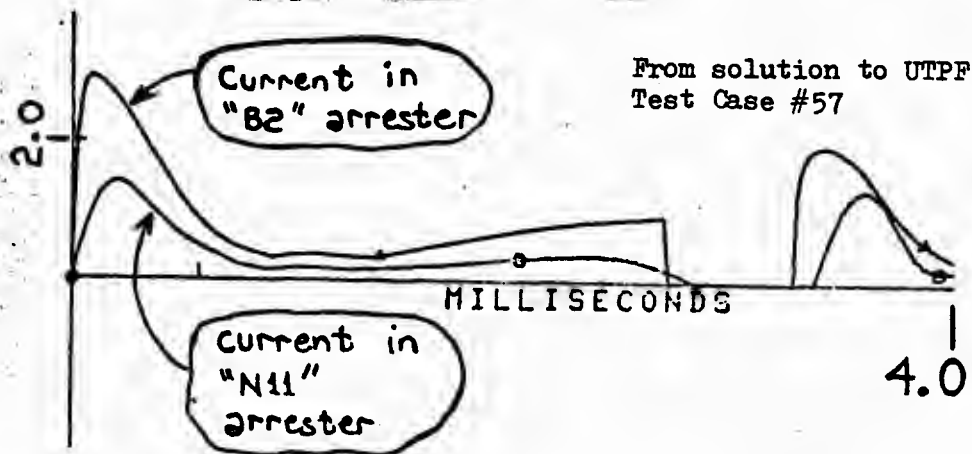
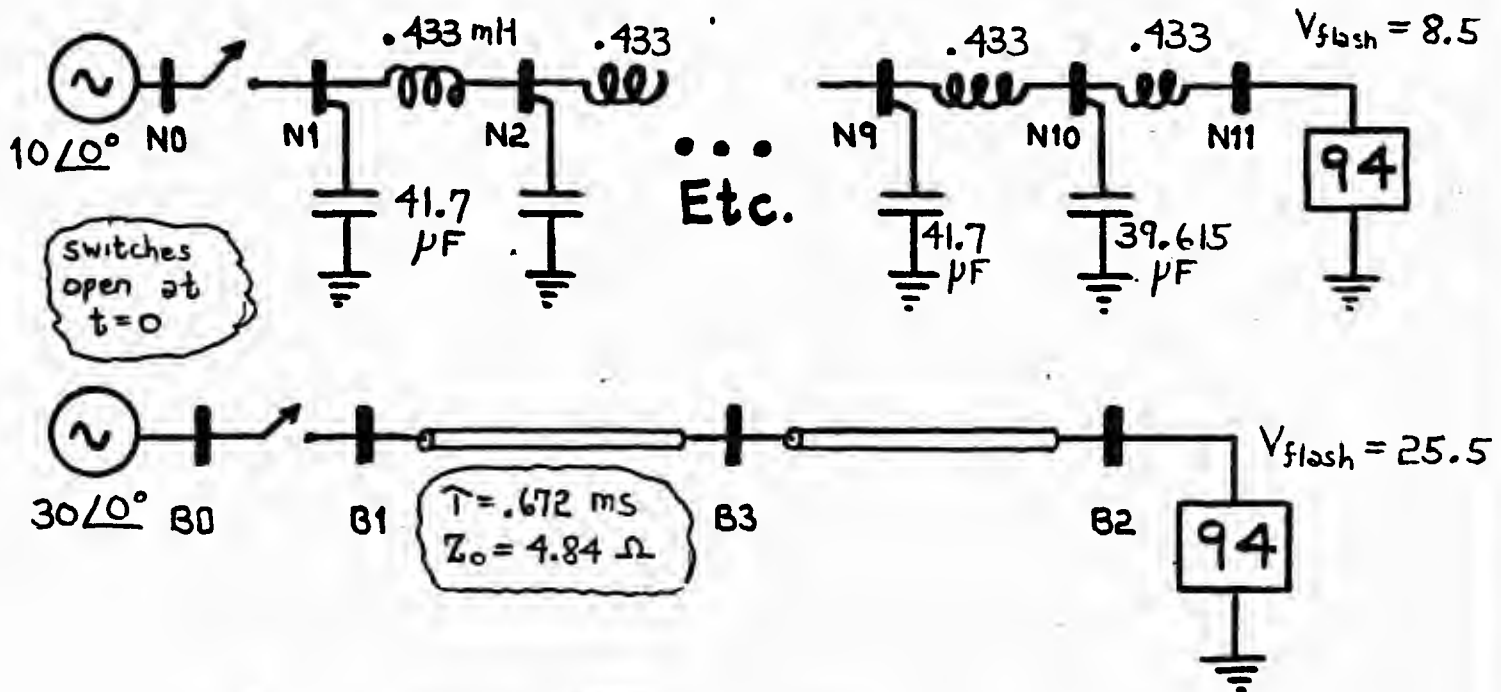

1.4 SWITCH CARDS

Cards inputted as part of this class of data input include the following:

1. "Ordinary" switches, for which the voltage drop is zero when closed, and for which the current is zero when open. Such switches bear the type code ITYPE = 0 (columns 1-2 of data card), or possibly ITYPE = 76 for exceptional "STATISTICS" switches.



4. TACS-controlled switch, wherein the switch status is controlled by TACS. Recall that TACS is the EMTP "digitally-simulated analog computer," as fully described in Section 8. . The TACS-controlled switch bears type code ITYPE = 11, 12 or 13 (cols 1-2 of data card). Important special cases of this general component capability are diodes and valves (as used for ac/dc conversion). See Sections 1.43, 1.44 and 1.45 for details.

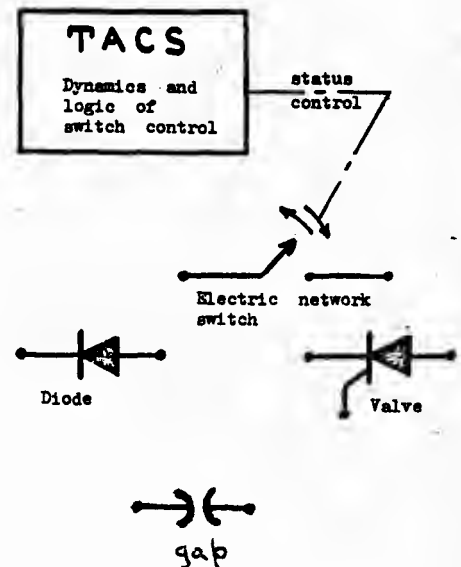

Such data cards are collectively referred to as switch cards, since in all cases the computer model for the element in question involves a "perfect" or "ordinary" switch. Such cards follow the regular EMTP branch cards, and precede the EMTP source cards.

If a network involves no such switch components, then the blank card ending switches immediately follows the blank card ending branches. "Not to worry" (the EMTP can handle this case without trouble).

If a case starts from zero initial conditions, no switches are necessary for connecting voltage and current sources to the network at time zero, provided the sources remain connected throughout the study.

Switches can be connected quite arbitrarily, although there are a few restrictions. One is that switch currents must be unique: there must be no loop involving closed switches. A more obvious restriction is that Kirchhoff's voltage law must not be violated for a loop involving a voltage source and a switch. For example, a closed switch must not be connected to two nodes of known voltage (including ground). The theoretical basis for such statements can be found in the technical papers which documented the "M32." installation of this new switch logic (Ref. 22, Vol. 2, No. 4, pp. 36-42, May

1982). Yet such restrictions seem almost never to be a problem for practically-formulated studies, so the average production user need not be concerned with them.

Along with the "M32." switch logic came a new, optional printout of steady-state phasor switch flows (both current and power can be monitored). The integer miscellaneous data parameter KSSOUT (cols. 25-32) continues to control such steady-state output, of which the following is a representative illustration (from BENCHMARK DC-32):

OUTPUT FOR STEADY STATE SWITCH CURRENT		I-IMAG			DEGREES	POWER	REACTIVE
NODE-K	NODE-M	I-REAL	I-IMAG	I-MAGN			
FAULT		OPEN	OPEN	OPEN		OPEN	OPEN
SECB	CATH1	OPEN	OPEN	OPEN		OPEN	OPEN
SECA	CATH2	0.16873295E+02	0.15329059E+02	0.22796670E+02	42.2545	0.13409098E+04	-0.12595678E+04
SECC	CATH3	OPEN	OPEN	OPEN		OPEN	OPEN
AN4	CATH4	0.24078446E+01	-0.20983161E+02	0.21120861E+02	-83.4539	-0.99120545E+03	-0.67237260E+03
AN5	CATH5	OPEN	OPEN	OPEN		OPEN	OPEN
AN6	CATH6	0.29476803E+01	0.34029172E+02	0.34156601E+02	85.0493	-0.98793323E+03	0.12053019E+04

Note that there are seven switches (actually, one switch and six diodes), with four of them open during the phasor steady-state solution. If such phasor switch output is requested (KSSOUT positive), it will follow the phasor branch flows, and precede the injections at nodes of known voltage.

Also a result of the "M32." switch logic is the correct assignment of switch currents at time zero for purposes of printing and/or plotting. Prior program versions would assume zero values for purposes of such outputs at time zero, it may be recalled. But today, for any switch which is closed in the steady state, printed and plotted values will be correctly assigned for step zero. Also, all such switch currents at time zero can be seen from new printout which immediately follows the variable heading of the time-step loop. As an illustration, again consider BENCHMARK DC-32 at and immediately above the printout for step zero:

	AN5	AN6	SECB	SECA	SECC	AN4	AN5	AN6	TRANA
	CATH5	CATH6	CATH1	CATH2	CATH3	CATH4	CATH5	CATH6	GENB
***	PHASOR I(0) =	0.1687330E+02			SWITCH "SECA "	TO "CATH2 "	CLOSED AFTER	0.00000E+00	SEC
***	PHASOR I(0) =	0.2407845E+01			SWITCH "AN4 "	TO "CATH4 "	CLOSED AFTER	0.00000E+00	SEC
***	PHASOR I(0) =	0.2947680E+01			SWITCH "AN6 "	TO "CATH6 "	CLOSED AFTER	0.00000E+00	SEC
0	0.00000E+00	-0.358383E+01	-0.358383E+01	0.127072E+02	-0.753039E+02	-0.679347E+02	-0.739543E+02	-0.753039E+02	0.161380E+03
		-0.739543E+03	-0.739543E+03	0.770132E+02	0.671413E+00	-0.819947E+02	0.806896E+02	-0.679347E+02	0.770132E+02
		-0.799739E+04	-0.799739E+04						

The printed "PHASOR I(0)" equals the real part of the complex phasor switch current of the steady-state display, of course. Such output will be found for any switch which was closed during the phasor solution (three of them for this example). Unlike earlier program versions, note that the closing times for these switches are now zero. No longer can one look for such a negative value (typically -1.0 was used), and conclude that the switch was closed during the phasor solution. Now, it is a nonzero "PHASOR I(0)" value which reflects such a state.

1.40 ORDINARY SWITCH

Switches which are not diodes, valves, or gaps are of five different basic types or classes, as follows:

- Class 1 : Conventional (i.e., deterministic) time-controlled switch.
- Class 2 : Voltage-controlled (flashover) switch.
- Class 3a: "STATISTICS" switch (a time-controlled switch for which the closing or opening time is a random variable).
- Class 3b: "SYSTEMATIC" switch (a time-controlled switch for which the closing time is systematically [regularly] varied).

b) Specify inductance L as

i) inductance L in mH if $XOPT=0$.

ii) reactance ωL in ohms at frequency $\frac{\omega}{2\pi} = XOPT$ if $XOPT \neq 0$.

c) Specify capacitance C_{ij} as

i) capacitance C in μF if $COPT=0$.

ii) susceptance ωC in $\mu mhos$ at frequency $\frac{\omega}{2\pi} = COPT$ if $COPT \neq 0$.

7) Output options for printing and/or plotting:

Punch "1" in column 80 to get branch current;

" " "2" " " " to get branch voltage,

" " "3" " " " to get both branch voltage and current;

" " "4" " " " to get branch power and energy consumption (see details in Section 1.8).

b) FORMAT & EXAMPLES

ITYPE	NODE NAMES		NODE NAMES OF REFERENCE BRANCH		R (Ω)	L (mH) or ωL (Ω)	C (μF) or ωC ($\mu mhos$)	OUTPUT OPTION
	BUS1	BUS2	BUS3	BUS4				
Format: I2	A6	A6	A6	A6	E6.2	E6.2	E6.2	
Examples	0 VOLT-A	10-A			1.	123.	.21E-3	3 1
	0 BUSA	BUSB				12.8		
	0 VOLT-B	10-B	VOLT-A	10-A				
	0 PORT				300.			

Above examples (assuming $XOPT=0$ and $COPT=60$):

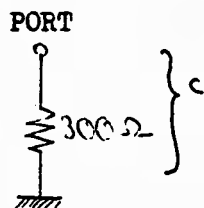
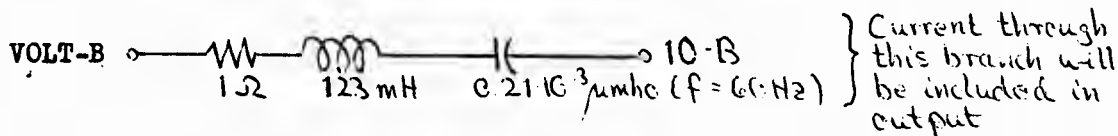
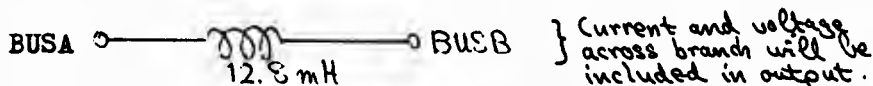
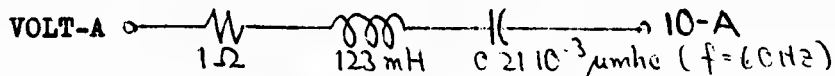

Class 4 : "MEASURING" switch, which is permanently closed for all time, by definition. It is used just for current or power and energy monitoring.

Class 5 : TACS-controlled switch (including diodes, valves, etc.).

Class 1 :

Time-controlled switch (circuit breaker pole): Switch is open originally, closes at $t \geq T_{CLOSE}$ and tries to open again after $t \geq T_{OPEN}$. In option A the opening is successful as soon as the current i_{SWITCH} has gone through zero (detected by a sign change in i_{SWITCH}). In option B the opening is successful as soon as $|i_{SWITCH}| < \text{CURRENT MARGIN}$ or as soon as i_{SWITCH} has gone through zero. After a successful opening, the switch will stay open.

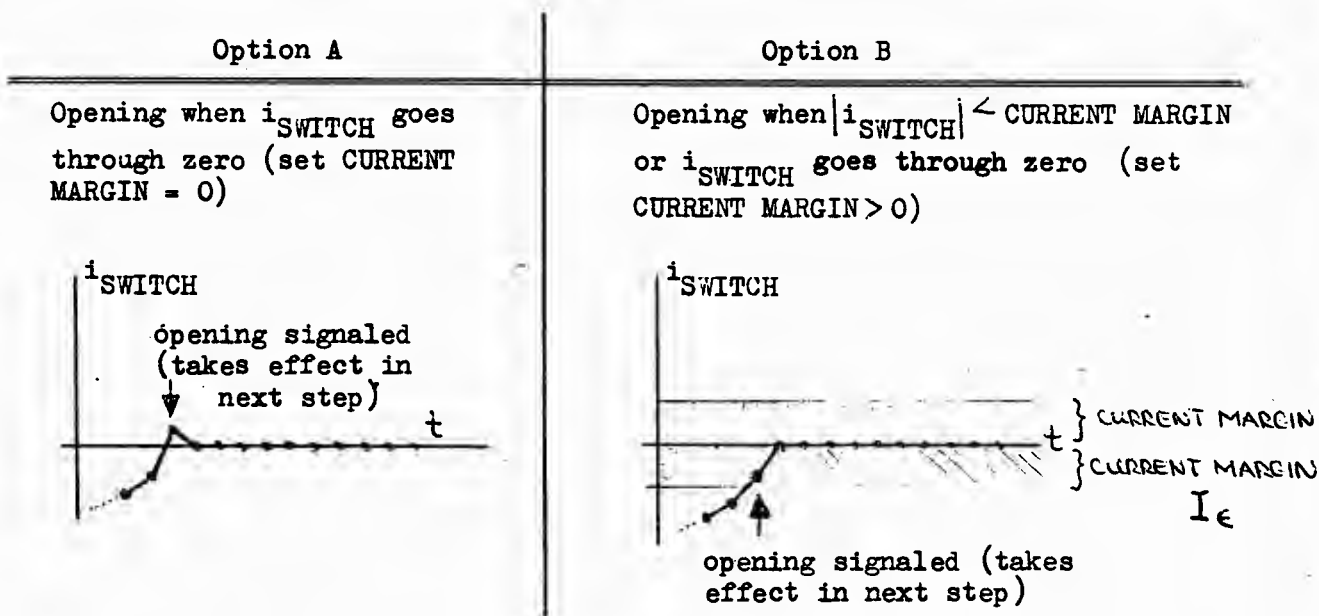

Class 2 :

Flashover-controlled switch (gap): Switch is open originally and tries to close after $t \geq T_{CLOSE}$. The closing is successful as soon as the absolute value of the voltage across the switch is $\geq \text{FLASHOVER VOLTAGE}$. After switch has closed, it waits until the time delay T_{DELAY} has elapsed and then tries to open again with the same current criteria as in option A and B above. The sequence "(1) flashover-controlled closing \rightarrow (2) elapse of time $T_{DELAY} \rightarrow$ (3) current-controlled opening \rightarrow back to (1)" remains effective throughout the study (see figure below).

There are cases where the voltage across the gap oscillates around the true value. An example of this is the case of an inductance "hanging in the air", as per the sketch. To avoid such problems, the gap voltage for checking flashover is computed as the average of the last two time-step figures:

$$v_{gap}(t) = \left(\frac{v(t) + v(t - \Delta t)}{2} \right)$$

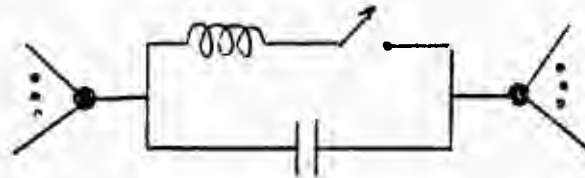

	Class 1 (time-controlled switch)	Class 2 (flashover switch)	Class 4 ("MEASURING" switch)
Columns 15-24 (in seconds)	Actual switch closing time. T_{close}	Time before which the switch is prevented from flashing over. T_{close}	—
Columns 25-34 (in seconds)	Time before which opening will not be allowed. T_{open}	Time elapsed after flashover, before which opening will not be allowed. T_{delay}	—
Columns 35-44 (in units of current)	Current margin which is used to determine when switch opening is possible. I_{ϵ}		—
Columns 45-54 (in units of voltage)	—	Voltage which must be exceeded for switch to close. V_{flash}	—
Columns 55-64	—	—	"MEASURING "

	Class 3a "STATISTICS" switch		Class 3b "SYSTEMATIC" switch	
	independent	dependent	independent	dependent
Columns 15-24 (in seconds)	Mean closing time. \bar{T}	Mean \bar{T}_B of random time delay T_{random}^B	Mid-time T_{mid} if ITEST = 0. Beginning time T_{beg} if ITEST = 1	Constant delay time. T_{offset}^B
Columns 25-34 (in seconds)	Standard deviation of switch closing time. σ	Standard deviation σ_B of random time delay T_{random}^B	Size of time increment (or step). ΔT	—
Columns 35-44	I_{ϵ}	I_{ϵ}	Number of time increments (or steps). $NSTEP$	—
Columns 45-54	—	—	—	—
Columns 55-64 (A10 format)	"STATISTICS"	"STATISTICS"	"SYSTEMATIC"	"SYSTEMATIC"
Columns 65-70 (A6 format)	possibly "TARGET"	BUS5 Node names of reference switch	possibly "TARGET"	BUS5 Node names of reference switch
Columns 71-76 (A6 format)	—	BUS6	—	BUS6

The closing time T_{close} for each "STATISTICS" switch is randomly varied according to either a Gaussian (normal) distribution or a uniform distribution, as illustrated in Fig. 2. Choice as to distribution type is generally controlled by appropriate selection of variable "IDIST" (statistics miscellaneous data parameter; see Section 1.1a) by the user. Then with all switch type codes "ITYPE" (cols. 1-2 of the switch card) zero or blank, all "STATISTICS" switches will use Gaussian distributions if "IDIST" is zero, or uniform distributions if "IDIST" is unity. In order to use both distribution types within the same data case, the user makes "IDIST" equal to zero, and leaves the Gaussian-distributed switches with type code "ITYPE" equal to zero or blank; the exceptional switches which are to have uniform distributions are then flagged by punching the type code "ITYPE" equal to 76. Fig. 2 illustrates the two available distribution types for "STATISTICS" switches. The mean closing time \bar{T} and associated standard deviation σ are specified by the user on the one or more "STATISTICS" switch cards.

In addition to switch closing-time variation caused by each switch's own distribution, there is an added random delay which is the same for all switches, provided the user has given variable "ITEST" (statistics miscellaneous data parameter; see Section 1.1a) a value of zero or blank. This added random delay which is applied equally to all "STATISTICS" switches is referred to by the term "reference angle"; it follows a uniform distribution always, the probability distribution for which is specified using parameters "DEGMIN", "DEGMAX", and "STATFR" of the statistics miscellaneous data card (see Section 1.1a). Line printer output for a statistical overvoltage study will show the reference angle for each energization, in approximately the columns which are normally used for the step number and time value (marked "STEP" and "TIME") of a conventional deterministic (non-"STATISTICS") data case. The numerical value printed out will be in degrees, and will lie somewhere between "DEGMIN" and "DEGMAX", of course. If the user punches "ITEST" equal to unity, the reference angle will simply be constrained to always be zero ---- which is mathematically equivalent to not having any added random delay.

The preceding discussion about "STATISTICS" switches mentioned nothing about the possible dependence of the closing time of one switch on that of a second switch (with both switches being "STATISTICS" switches). Where no such dependence exists, switch cards are completely independent, and the parameters affecting any one switch are totally contained on the switch card for that switch. This is perhaps the most common, and certainly the simplest, usage.

But there also is the capability for dependent "STATISTICS" switches. The closing time of a switch labeled "B" can be made equal to the sum of two components:

$$T_{\text{close}}^B = T_{\text{close}}^A + T_{\text{random}}^B$$



where:

$$T_{\text{close}}^A = \text{previously-determined closing time of another "STATISTICS" switch, labeled here as switch "A". This is a random variable, note, not a constant.}$$



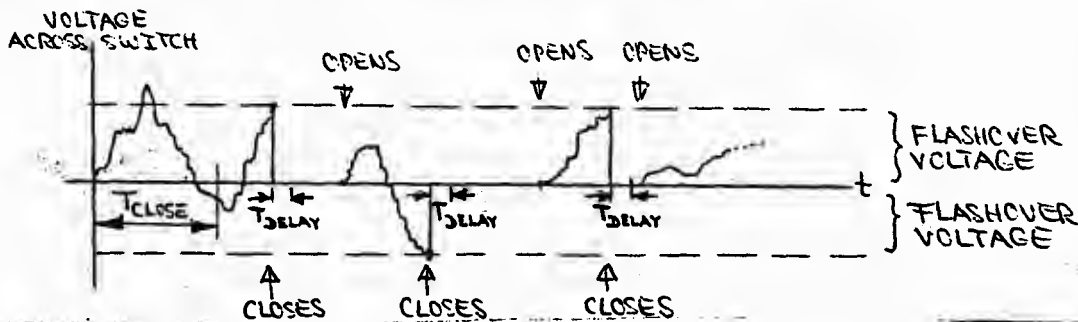
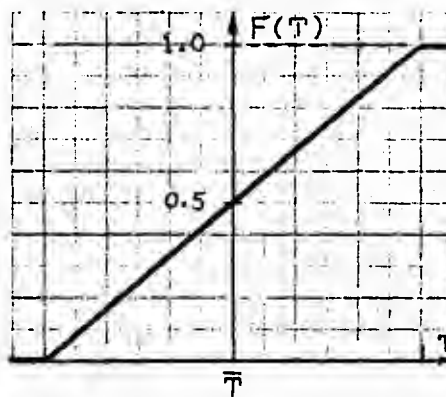
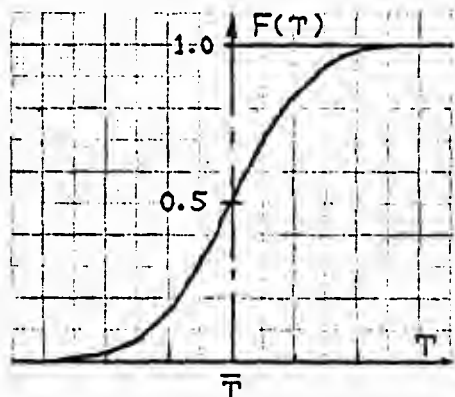
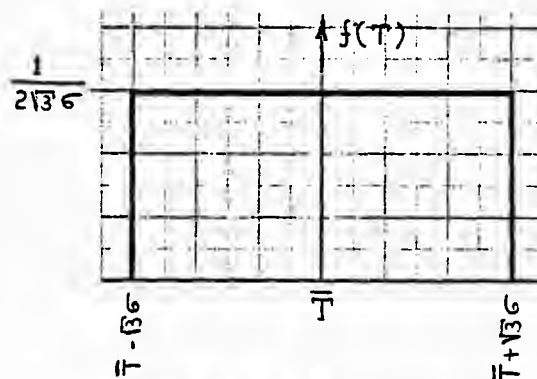
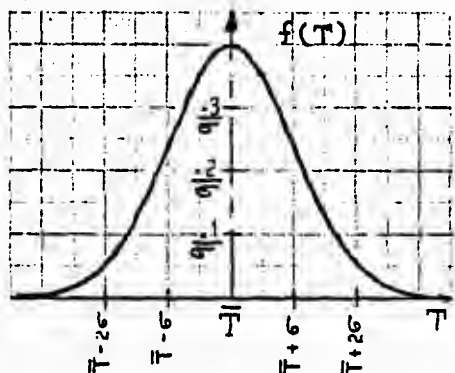

Fig. 1. Sample illustrative operation of flashover-controlled switch.

Class 3a:
"STATISTICS" switch

A statistical overvoltage study consists of "NENERG" (miscellaneous data parameter; see Section 1.0h) separate internally-generated simulations, the peak voltages of which are then processed statistically. The data case in question for such a study contains one or more switches the closing times of which are random variables. Such randomly-closed switches are called "STATISTICS" switches, so named after the key request word "STATISTICS" which must be punched in columns 55-64 of the switch card in question. "STATISTICS" switches are always initially open (in particular, they are always treated as being open for the phasor steady-state solution); they then close once at the appropriate random times (as determined by their probabilistic specifications), never to open again.



a) Gaussian (normal) distribution.
 IDIST = 0 (and ITYPE ≠ 76).

b) Uniform distribution.
 IDIST = 1 (or ITYPE = 76).

Fig. 2. Available probability distributions for the closing time T_{close} of a "STATISTICS" switch. Density functions $f(T)$ are shown above, and cumulative distribution functions $F(T)$ below.

T_{random}^B = random time delay having mean \bar{T}_B and standard deviation σ_B (parameters as punched on the data card for switch "B"). If desired, the mean \bar{T}_B of this component can be negative. The only constraint which must be kept in mind is that the resulting actual switch closing times must only very infrequently turn out to be less than the beginning time of the simulation (which is usually zero).

But switch "A" might itself in turn depend on a third switch "Z". The EMTP allows an arbitrary number of such dependencies. In terms of the above example, switch "B" is called a dependent (or slave) switch, while switch "A" is the reference (or master) switch. An arbitrary number of levels of servitude are permitted.

The identification or specification of reference switch "A" in the above example is actually made using the two 6-character alphanumeric bus names of the switch. The names of this reference switch "A" are to be punched using 2A6 format in columns 65-76 of the data card for dependent switch "B". This is the way in which the EMTP distinguishes between dependent and independent "STATISTICS" switches: whether or not columns 65-76 are non-blank.

A specialized data-convenience option is provided by the "TARGET" feature. Any non-dependent "STATISTICS" switch can be designated as a "TARGET" switch by punching this key word in columns 65-70 of the switch card. Only one such designation is permitted in any one data case. The effect is that all other non-dependent "STATISTICS" switches will be internally given mean closing times which are equal to the mean closing time of the "TARGET" switch. Several details might be noted:

- a) Only convenience of data punching is involved, for the "TARGET" option does not extend the modeling capability at all.
- b) Nothing has been said about standard deviations σ . It is only the mean closing time \bar{T} which is affected by the use of "TARGET".
- c) Columns 15-24 of non-"TARGET", non-dependent "STATISTICS" switch cards can be left blank (since the mean closing time will come from the "TARGET" switch).

Random switch opening

All of the preceding text of this section applies to the random closing of "STATISTICS" switches. Then along came the demand for random opening late in 1979 (see Ref. 8, Vol. IX, 6 November 1979, pages EOVN-1 to 3). Two key paragraphs from the memo writeup are reproduced here:

Special Switch-Card Flag for Random Opening

For random opening of a switch, columns 45-54 of the switch card are to be punched with the special numerical flag "3333.". Otherwise, data fields are unchanged (see pages 27a and 27e of the EMTP User's Manual) — except that "closing" is to be read as "opening" wherever it is encountered. That is, the mean opening time \bar{T} goes in columns 15-24, the standard deviation σ goes in columns 25-34, and the key-word "STATISTICS" must be punched in columns 55-64. The use of "TARGET" or dependency of switches is also allowed, according to the same rules as before. In fact, the user can mix random opening and random closing within the dependency chain, if so desired.

First, a word of caution about opening times. A switch which is to randomly open starts out as being closed in the steady-state, and it is subsequently inhibited from opening until the time which is determined by rolling the dice. But switch current is not generally zero at this instant of time. The actual opening is delayed until the switch current goes through zero. If this never happens, the switch will never open.

The user of random opening should read Section 1.0e12, wherein TENERG can be defined using "TIME OF DICE ROLL". It is crucial as of April 1980 that TENERG be negative in the case of random opening, as explained on page EOVN-3 of the memo. Either this is done automatically by "SYSDEP" (most computer versions should be set up that way), or else it must be done manually using the request of Section 1.0e12.

A positive current margin I (columns 35-44) can be used for random opening switches. When this is done, the random opening switch would open after $T > \text{or} = T_{\text{open}}$ and as soon as $|I_{\text{switch}}| < I$ or as soon as $I_{\text{switch}} = 0$.

Class 3b :

"SYSTEMATIC" switch

An EMTP study which involves a "SYSTEMATIC" switch consists of $|NENERG|$ (miscellaneous data parameter; see Section 1.0h) separate internally-generated simulations, the peak voltages of which are then processed and tabulated statistically. Each "SYSTEMATIC" switch has its closing time systematically (regularly) varied between a given beginning and ending time, in steps which are uniformly spaced. Such systematically-varied switches are named "SYSTEMATIC" switches after the key request word "SYSTEMATIC" which must be punched in columns 55-64 of the switch card in question. "SYSTEMATIC" switches are always initially open (in particular, they are always treated as being open for the phasor steady-state solution); they then close once at the appropriate systematic time, never to open again.

Note specifically the minus sign which is a part of "NENERG"; it is used to definitively distinguish a "SYSTEMATIC" data case from a "STATISTICS" data case, as the data input begins.

The user is warned of the potentially enormous number of energizations which can be involved in a "SYSTEMATIC" data case. As an example, consider a data case which has three independent "SYSTEMATIC" switches. Then one can think of the internally-generated energizations as being a methodical exploration of a rectangular region of the 3-dimensional vector space of switch closing times (see sketch above).

For example, if switch "A" were to take 6 steps, switch "B" 5 steps, and switch "C" 4 steps, then a total of $|NENERG| = 120 = 6 \times 5 \times 4$ energizations would be internally generated by the EMTP.

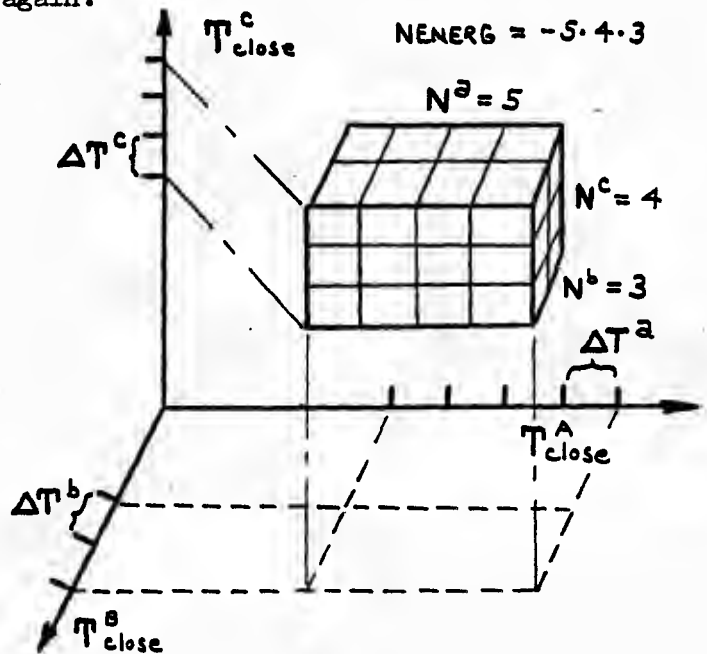

Dependency among "SYSTEMATIC" switches is permitted, and deserves an explanation. The general concept is similar to that for "STATISTICS" switches, but with several crucial differences. Let switch "B" be the dependent switch, and switch "A" the reference switch, as before. Then the closing time of dependent switch "B" is not independently varied, but rather is offset by a fixed amount from the closing time of the reference switch "A" :

$$T_{\text{close}}^B = T_{\text{close}}^A + T_{\text{offset}}^B$$

Here T_{offset}^B is a constant (it has the same value for all energizations). Rather than a beginning (or mid) time, a step-size, and a number of steps, the input time-data for a dependent "SYSTEMATIC" switch consists of only the constant offset time, which is to be punched in columns 15-24. A dependent "SYSTEMATIC" switch does not increase the dimensionality of the vector space of switch closing times which is to be systematically explored, note. The mechanism for indicating the dependence of a "SYSTEMATIC" switch is identical to that which is used for a "STATISTICS" switch; the node names of the reference switch are to be punched in columns 65-76 of the card for the dependent switch.

For each non-dependent "SYSTEMATIC" switch card, the size of the time increments ΔT is to be punched in columns 25-34. The number of steps NSTEP is to be punched in columns 35-44. The third and final time-parameter is to be punched in columns 15-24, and it depends on the value of "ITEST" (miscellaneous data parameter of Section 1.1a) :

$$\text{ITEST} = \begin{cases} 0 & \Rightarrow \text{punch the mid-time } T_{\text{mid}} \\ 1 & \Rightarrow \text{punch the beginning time } T_{\text{beg}} \end{cases}$$

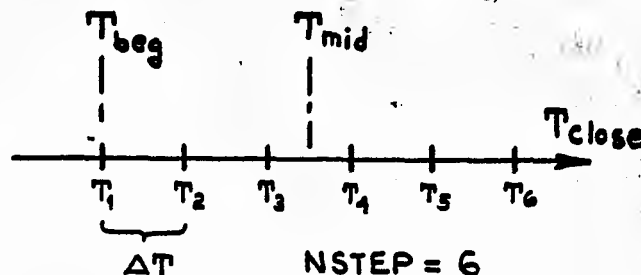

A specialized data-convenience option is provided by the "TARGET" feature. Any non-dependent "SYSTEMATIC" switch can be designated as a "TARGET" switch by punching this key word in columns 65-70 of the switch card. Only one such designation is permitted in any one data case. The effect is that all other non-dependent "SYSTEMATIC" switches will be internally given mid-times or beginning times which are equal to that of the "TARGET" switch. Several details might be noted:

- a) Only convenience of data punching is involved, for the "TARGET" option does not extend the modeling capability at all.
- b) Nothing has been said about the time increment ΔT and the number of steps NSTEP. It is only the mid-time or the beginning time which is affected by the use of "TARGET".
- c) Columns 15-24 of non-"TARGET", non-dependent "SYSTEMATIC" switch cards can be left blank (since the beginning or mid-time will come from the "TARGET" switch).

Class 4 :

"MEASURING" switch

By definition, a "MEASURING" switch is permanently closed for all time (including any phasor steady-state solution for initial conditions). It is used for the monitoring of current, or power and energy, in places where these quantities are not otherwise available. This may be for EMTP output purposes (printing or plotting), or in conjunction with use of the Type-91 TACS signal source (see Section 8.5.4).

To request a measuring switch, the key word "MEASURING" is to be punched in columns 55-64 of the switch card. The terminal bus names "BUS1" and "BUS2" must be punched as 2A6 information in columns 3-14, of course. Then it is only a possible column-80 punch for output purposes which is needed; the rest of the data card can be left blank.

a) Rules for Ordinary Switches

- 0) The switch type code (data card field ITYPE ; columns 1-2) is zero. Either the zero may be punched, or the field may be left blank.

A special exception is type code ITYPE = 76 . This is for a "STATISTICS" switch that the user wants to follow a uniform distribution, in a problem with one or more "STATISTICS" switches which follow Gaussian distributions (statistics misc. data parameter "IDIST" equal to zero).

- 1) Specify the two terminal nodes by names (fields BUS1 and BUS2 ; columns 3-14). One of the nodes may be ground, indicated by a blank field for the associated name.
- 2) The old restriction that a non-voltage source node may have only one switch connected to it has been removed since "M32." version of the EMTP.

- 3) No switch is permitted between two voltage sources, or between one voltage source and ground. Such a condition is absurd, of course, leading to a contradiction. The program will flag such a situation with an error message.
 - 4) If a switch connects a voltage source to a current source, then the current source is ignored whenever the switch is closed.
 - 5) Floating-point parameters and special request word which are to be punched on an "ordinary" switch card are dependent upon switch Class, as per the previously-displayed tables.
-
- 6) If transients start from a non-zero ac steady-state condition, make $T_{CLOSE} < 0$ for time-controlled switches which are closed in the ac steady-state condition. Flashover-controlled switches will always be open in the ac steady-state; if the user punches $T_{CLOSE} < 0$ on these switch types, the program will change it to $T_{CLOSE} = 0$ with the message " T_{CLOSE} CHANGED TO 0."

For a "STATISTICS" switch, it is the mean closing time \bar{T} , the expected value or mathematical expectation of the random closing time T_{close} , $\bar{T} = E\{T_{close}\}$, which is inputted by the user. Not only had this mean better be positive, but the particular switch closing times generated from the specified distribution had better almost always be positive also. This is because negative time in an EMTP simulation corresponds to the sinusoidal steady-state solution, into which we are powerless to inject switching events. To avoid such trouble, the simple requirement that $\bar{T} - A \cdot \sigma$ be positive is made upon data input, where "A" is a constant which depends upon distribution type:

$$A = \begin{cases} \text{SIGMAX} & \text{if Gaussian (normal) distribution.} \\ & \text{See Section 1.1 definition (user-supplied parameter which is defaulted to 4.0 if left blank).} \\ \sqrt{3} & \text{if uniform distribution} \end{cases}$$

A fatal EMTP error termination is the result, if this check is not satisfied for all "STATISTICS" switches. For a Gaussian distribution, this check ensures that any particular switch closing time turning out negative has probability which is less than 0.005%; for a uniform distribution, this guarantees that all switch closing times will always be positive (see Fig. 2). For dependent switches in which Gaussian and uniform distribution offsets are mixed, the "SIGMAX" value is applicable to the Gaussian components and the square root of three is used on all uniform components.

- 7) For either a "STATISTICS" or a "SYSTEMATIC" switch, the special request word "STATISTICS" or "SYSTEMATIC" must be punched in the field of columns 55-64. Be sure to spell such request words correctly, and begin in column number 55 ; if not, a Class-1 switch will result, rather than the desired Class-3a or Class-3b switch.

- 8) If a switch is chosen to be the "TARGET" switch of either a "STATISTICS" or a "SYSTEMATIC" data case, then this key word "TARGET" must be punched in columns 65-70 of that switch card. Only one switch card of a given data case might be so punched (there is at most one "TARGET" switch, by definition).

- 9) A dependent "STATISTICS" or "SYSTEMATIC" switch is to have the terminal node names of the reference switch punched in columns 65-76 . The format is 2A6 .

- 10) Output options for printing and/or plotting are punched in column 80, as follows:
 - "1" punch is a request for switch current output;
 - "2" punch is a request for switch voltage output;
 - "3" punch is a request for both switch current and voltage output;
 - "4" punch is a request for switch power and energy flow (see Section 1.8 for details).

The column positions and mode in which the various switch parameters for an "ordinary" switch are to be punched are indicated by the following format:

ITYPE	Node names		Time Criteria		I _c or NSTEP	Flashover Voltage V _{flash}	Special Request Word Column	Reference Switch Names, or "TARGET..."		Output option
	BUS1	BUS2	T _{close} or T _{open}	T _{open} ± or T _{delay} ΔT				BUS5	BUS6	
12	A6	A6	E10.0	E10.0	E10.0	E10.0	A10	A6	A6	13

Sample of "ordinary" switch specification

As an example of the preceding "ordinary" switch rules and data format specification, consider the four sample usages of the following listing:

1	BUS-1	BUS-2			.001					
2	BUS-3	BUS-4	.0005		.002	.001				
3	GAP-1	GAP-2				.1	1.E6			
4	JDAYGA	JDAYA	.002		.0004			STATISTICS		
5	AS	ASW	.003		.0001	12.		SYSTEMATIC		
6	BS	BSW	.004		.0005			STATISTICS	TARGET	
7	CS	CSW	.002		.0001	2.		SYSTEMATIC	TARGET	
8	DS	DSW	.006		.0002			STATISTICS	AS	ASW
9	ES	ESW	.005					SYSTEMATIC	CS	CSW

As verbal explanation of these:

1. breaker pole "BUS-1" to "BUS-2" closes at $t = 0$ and opens after $t \geq 0.001s$ as soon as current goes through 0.
2. breaker pole "BUS-3" to "BUS-4" closes at $t \geq 0.0005s$ and opens after $t \geq 0.002s$ as soon as absolute value of switch current is < 0.001 AMPS or goes through zero.
3. gap "GAP-1" to "GAP-2" closes whenever voltage across switch becomes $\geq 1\ 000\ 000$ VOLTS and opens as soon as absolute value of switch current becomes < 0.1 AMPS or goes through zero.
4. "STATISTICS" switch connecting node "JDAYGA" with node "JDAYA" has mean closing time of 2.0 msec and associated standard deviation of 0.4 msec. Assuming that statistics miscellaneous data parameter "IDIST" is zero, the probabilistic distribution will be Gaussian (normal). This assumes that there is no "TARGET" "STATISTICS" switch in the data case.

5. Non-dependent "SYSTEMATIC" switch that connects node "AS " with node "ASW " . The mid-closing-time is 3.0 msec , assuming "ITEST" is zero and that the data case in question has no "TARGET" switch. The closing time of the switch is to be varied in steps of size 0.1 msec ; 12 steps are to be taken.
6. "STATISTICS" switch connecting node "BS " with node "BSW " is the "TARGET" switch for the data case in question. All non-dependent "STATISTICS" switches of the data case will have the same mean closing time of 4.0 msec . That is, the information which is punched in columns 15-24 of all other non-dependent "STATISTICS" switches is over-ridden by the value for the present "TARGET" switch. The standard deviation of the closing time for this "TARGET" switch is 0.5 msec .
7. "SYSTEMATIC" switch connecting node "CS " with node "CSW " is the "TARGET" switch for the data case. All non-dependent "SYSTEMATIC" switches of the data case have the same mid-closing time of 2.0 msec (if "ITEST" is zero), or the same beginning closing time of 2.0 msec (if "ITEST" is unity). The information of columns 15-24 on all other non-dependent "SYSTEMATIC" switch cards is over-ridden by the value on the "TARGET" switch card (that now being discussed). The closing time of this switch is to be varied through 8 steps; the step-size is 0.1 msec .
8. The switch connecting node "DS " with node "DSW " is a dependent "STATISTICS" switch. Its reference switch is the one connecting node "AS with node "ASW " . Note that (or remember that) the reference switch must have been previously inputted. The closing time of the present switch is delayed from that of its reference by a random delay time which has a mean of 6.0 msec and a standard deviation of 0.2 msec .
9. The switch connecting node "ES " with node "ESW " is a dependent "SYSTEMATIC" switch. Its reference switch is the one which connects node "CS " with node "CSW " . The closing time of the present switch is offset (delayed) from that of its reference by a constant offset time of -5.0 msec . That is, the present switch will always close 5.0 msec before closure of the reference switch.

c) REMARKS ON OPENING ACTION

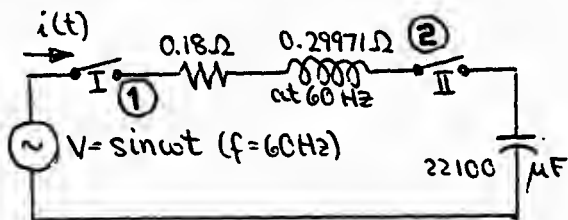

The circuit on the left is used to indicate the difficulties which can result during the opening of a switch in a physically improper model: Assume that both switches I and II are closed at $t = 0$. Then a transient current $i(t)$ will charge the capacitor. Switch II shall open as soon as $i(t)$ is approximately zero. In the time step in which the opening is signaled (i_{switch}

changing sign in option A, $|i_{\text{switch}}| < \text{CURRENT MARGIN}$ or i_{SWITCH} changing sign in option B), there will still be a residual current Δi through the inductance L . The next time step will find switch II open with no path left to dissipate the rest energy $\frac{1}{2} L (\Delta i)^2$. As a result, the computer cannot find the correct voltage $V_2(t)$ anymore (see left figure below). It should be noted that the incapability of the computer is a consequence of improper modeling. By putting a very small fraction of the capacitance over onto the left side of the switch, a path is provided for dissipating the rest energy, and a solution becomes possible again (see right figure below).

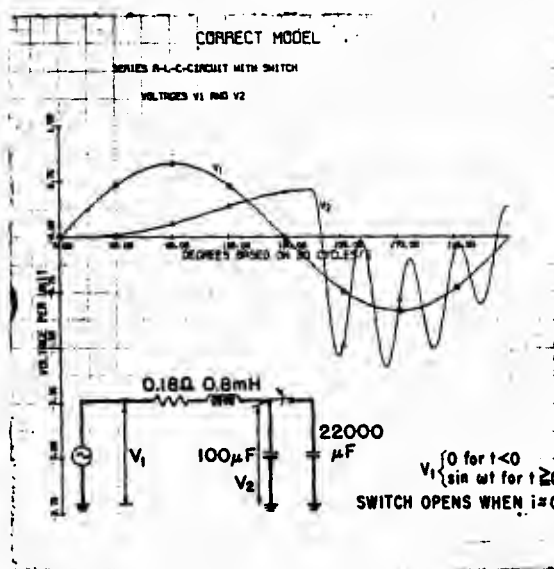
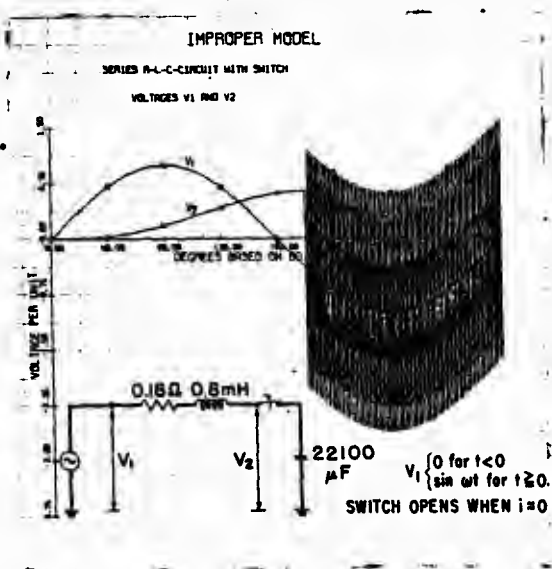

With $\text{CURRENT MARGIN} = 0$, the switch will open as soon as i_{SWITCH} changes its sign. Since the value of the current might be larger in the step where the sign change is noticed as compared with the value in the preceding step, it is advisable to use a non-zero current margin. See figures below.

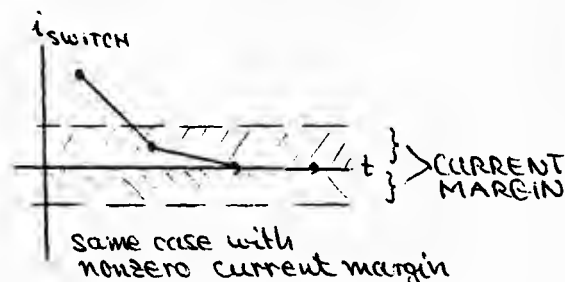
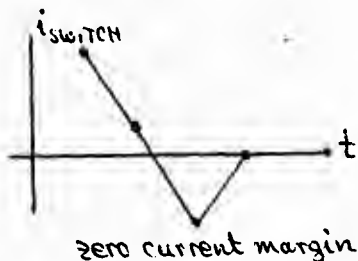

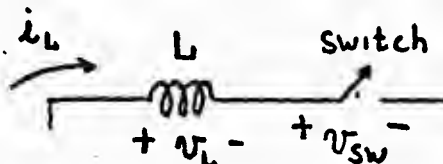

Added later insight (circa November, 1975)

The above comments are true; nonzero switch current at the instant of opening will cause trouble. But the problem is far more fundamental. There will in fact be voltage oscillations even though the switch opening occurs exactly at a current zero. The problem is inherent to the trapezoidal rule of integration which is being used, as explained in Reference 8, Vol. IV, November 12, 1975. Using the present EMTP logic, there will always be a voltage oscillation when the current through a hanging inductor is interrupted. Decreasing "DELTA T" so as to decrease the "rest energy" will not solve this problem.

$$i_L(t) = i_L(t-\Delta t) + \frac{1}{L} \int_{t-\Delta t}^t v_L(\tau) d\tau \quad (1)$$

or $\frac{1}{L} \left(\frac{v_L(t-\Delta t) + v_L(t)}{2} \right) \Delta t = 0 \Rightarrow v_L(t) = -v_L(t-\Delta t) \quad (2)$

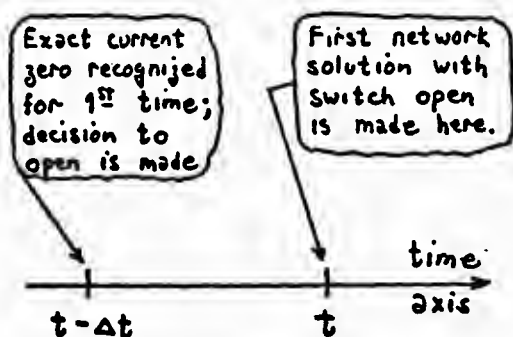

Fig. 6. Assumed switch opening schedule.

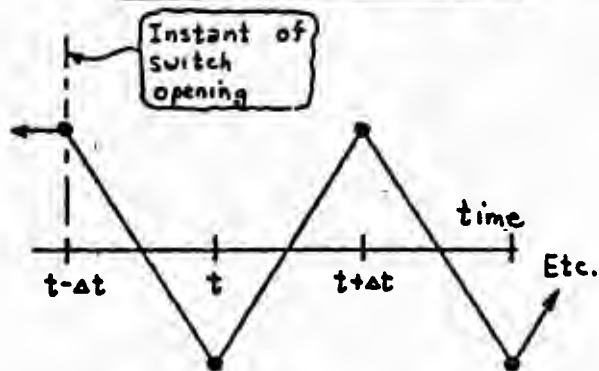

Fig. 7. Inductor voltage v_L for Figs. 5 and 6.

d) REMARK ON DELAY IN CLOSING ACTION OF SWITCHES

Except for a complication to be explained shortly, switch closing occurs as one would expect. When the program prints a message that a switch is closed after T seconds (see Fig. 1), it means that the closing occurs precisely at time t = T. For most cases, then, this is simple.

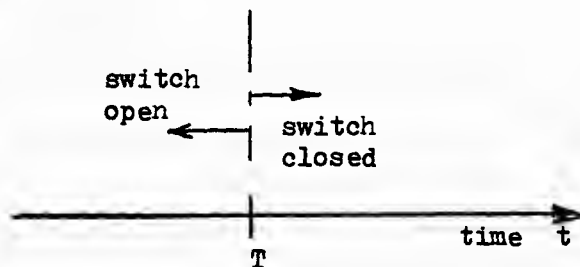

Fig. 1. Closing of switch at time instant t = T.

But a 1-step delay may actually occur in certain cases. A switch closing represents a change in the network; certain conditions (voltages, for example) immediately following the closure may be quite different than those immediately preceding the closure. In Fig. 1, we really should (ideally) get a network solution for t = T+, then. Among other things, this would clearly equalize the node voltages across the switch in question, and hence perhaps thereby initiate other flashovers which should also really be performed at time instant t = T+. But the program does not presently perform such extra solutions in the same time step. Equalization of node voltages for the just-closed switch will only occur as part of the network solution at time T+Δt, thereby introducing a delay of Δt.

Example

For the circuit of Fig. 2, with both the switch and type-99 (pseudo) nonlinear element open, no current flows. Hence source voltage $v_s(t)$ all appears across the switch, which will close when v_s exceeds flashover value V_{flash}^{sw} . At that instant the type-99 element should flashover too, assuming $V_{flash}^{99} < V_{flash}^{sw}$. But with present program logic, one time step would separate these two events.

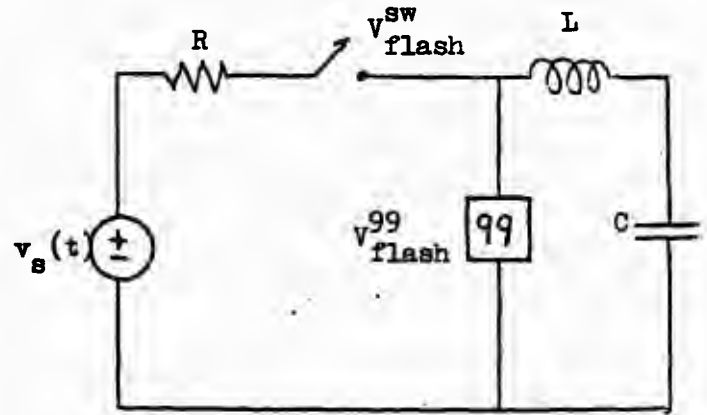

Fig. 2. Example illustrating delay.

1.43 TACS-CONTROLLED SWITCH TYPE-11
FOR DIODE AND VALVE APPLICATION

Used to simulate a switch which, while following the simple opening/closing rules of a standard diode, may simultaneously be controlled by any given TACS variable used as:

- a grid firing signal
- or an overriding OPEN/CLOSE signal .

This type-11 switch may thus represent any of the following:

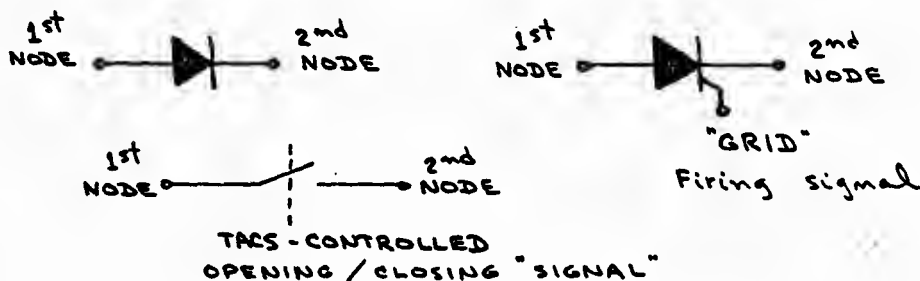

or a combination of any of those three modes, in which case either or both grid signal and overriding signal can simultaneously be active.

Besides the four alphanumeric node- and variable-names (used to define 1st-NODE, 2nd-NODE, and possibly -- but not necessarily -- "GRID" signal and "OPEN/CLOSE" signal), three additional parameters may be defined:

- the minimum ignition voltage (V_{ig}), defaulted to 0.0
- the minimum holding current (I_{HOLD}), defaulted to 0.0
- the de-ionization time (t_{DEION}), defaulted to 0.0 .

a) RULES

- 1) Punch 11 in columns 1-2 .
- 2) Specify the two terminal nodes by names (fields BUS1 and BUS2 of columns 3-14) . One of the nodes may be ground, indicated by a blank field. The direction of the current is taken to be from "BUS1" to "BUS2" . In other words, we have:

anode ---- always	"BUS1"	}	for valves or diodes
cathode ---- always	"BUS2"		

4) TACS grid signal and OPEN/CLOSE signal

- (a) if neither is specified, then the switch is a diode;



- : the diode starts conducting when the forward voltage across its terminals becomes greater than the minimum ignition voltage V_{ig} (defaulted to zero)
- : the diode ceases conducting as soon as the forward current becomes smaller than the minimum holding current I_{HOLD} (which is defaulted to zero)

- (b) if the grid signal is specified (identified by the alphanumeric TACS-variable name in columns 65-70), then the switch is a valve



- : which follows the opening and closing rules of the diode,
- : except that the closing operation (start of conduction) will not take place until the value of the grid signal becomes greater than zero;
- : unless the valve is actually reclosing within the de-ionization time following the previous opening, in which case the reclosing is immediate, with or without the presence of a valid grid signal. (Note that t_{DEION} is defaulted to zero.)

- (c) if the OPEN/CLOSE signal is specified (identified by the alphanumeric TACS-variable name in columns 71-76), then the operating rules of the diode or the valve are overridden as soon as this signal becomes different than zero;

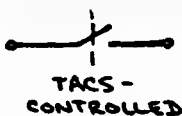

- : if positive, the switch will immediately close and stay closed as long as the positive signal is active;
- : if negative, the switch will immediately open and stay open as long as the negative signal is active;
- : if zero, the switch returns to its regular diode or valve operating mode.

- 5) The switch may be specified as closed during the program-calculated steady-state initialization, if the user punches the keyword "CLOSED" in columns 55-60 .
- 6) To facilitate the punching of cards, the user may use the option "SAME" (by punching the keyword "SAME" in columns 61-64), when data for the parametric fields (V_{ig} , I_{HOLD} , and t_{DEION}) have to be repeated on one or more cards that are placed immediately after the card bearing the definition of these parameters.
- 7) The user may obtain a printed echo of the occurrence of all opening and closing operations of the switch, by punching a "1" in column 79 . (No such diagnostic if left blank or zero.)
- 8) Output options for printing and/or plotting:

Punch "1" in column 80 to get switch current,
 " "2" " " " switch voltage,
 " "3" " " " both current and voltage,
 " "4" " " " switch power and energy flow.

(See Section 1.8)

1.44 TACS-CONTROLLED SWITCH TYPE-12
FOR SPARK GAP AND TRIAC APPLICATION

Used to simulate a spark gap or a triac, with firing controlled by a TACS variable.

OPERATION

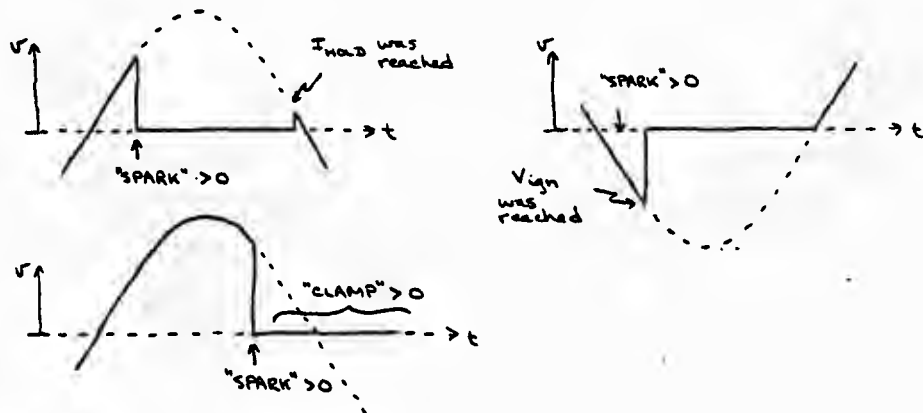

Opening/Closing Logic

"CLAMP" signal from TACS	{ undefined → depends on "SPARK" signal defined { = 0 → depends on "SPARK" signal < 0 { if closed → OPEN if open → maintain open > 0 { if closed → maintain closed if open → CLOSE } }
"SPARK" signal from TACS	{ undefined → maintain open defined { ≤ 0 { if open → maintain open if closed → depends on current > 0 { if open { if v < V _{ign} maintain open if v > V _{ign} CLOSE } if closed → maintain closed } }
current opening rules	{ i ≥ I _{hold} → maintain closed i < I _{hold} or if a } → OPEN current zero

1.45 SIMPLE TACS-CONTROLLED SWITCH TYPE-13

This type is used to represent a switch which is controlled by any given TACS variable.

The opening and closing operations are controlled by a single OPEN/CLOSE signal defined in columns 71-76 .

Comparison of switch type-11 type-12 and type-13

OPEN/CLOSE signal	type-11	type-12	type-13
< 0	OPEN	OPEN	OPEN
= 0	depends on GRID signal	depends on SPARK signal	OPEN
> 0	CLOSE	CLOSE	CLOSE

a) RULES

- 1) Punch 13 in columns 1-2 .
- 2) Specify the two terminal nodes by name (A6 fields BUS1 and BUS2 of columns 3-14). One of the nodes may be ground (blank).
- 4) The OPEN/CLOSE signal is identified by the TACS variable the name of which is punched in columns 71-76.
- 5) This switch is open during the program-calculated steady-state initialization at $t = 0.0$, unless the keyword "CLOSED" is punched in columns 55-60 .
- 6) The user may obtain a printed echo of the occurrence of all opening and closing operations of this switch, by punching a "1" in column 79 . (No such diagnostic if col. 79 is left blank or zero.)
- 7) Output options for printing and/or plotting:

Punch "1" in column 80	to get switch current
"2"	switch voltage
"3"	both current and voltage
"4"	switch power and energy flow (see Section 1.8)

note:

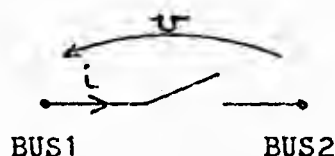

1.6 EMTP SOURCE COMPONENT DATA CARDS (SOURCE CARDS)

EMTP source components begin with conventional voltage and current sources which are analytic functions $f(t)$ of time. One terminal of these must always be grounded (see Rule 9 for ways of circumventing this restriction). Normally the function $f(t)$ can be chosen from a list of built-in function types, in which case the defining parameters are specified on the single source card. Up to ten functions of an arbitrary type can also be generated, as per Rule 4 immediately below. Finally, there are more complicated EMTP source components which have builtin differential equations (e.g., the 3-phase dynamic synchronous machine of Section 1.62).

If sinusoidal sources are active before the transient phenomena start (indicated by $TSTART < 0$), then the program will automatically pre-compute the correct ac steady-state conditions and use these as initial conditions (see rule 5).

RULES:

(Associated format with examples on page 34)

- 1) Specify the source by the name of the node to which it is connected (source is always from node to ground). See Rule 9 for non-grounded source.
- 2) Indicate a voltage source by punching a non-negative integer (≥ 0 or blank) in columns 9-10.
Indicate a current source by punching a negative integer (< 0) in columns 9-10 (current is measured into node).
- 4) The parameter TYPE specifies the type of the source function $f(t)$ [$e(t) = f(t)$ for a voltage source, $i(t) = f(t)$ for a current source]. All functions $f(t)$ are evaluated or read in at the discrete points $t = 0, \Delta t, 2\Delta t, \dots$ only; linear interpolation is assumed in between.

TYPE = 1, ..., 10: Up to 10 user-defined source functions $f(t)$ are possible, associated with source-type numbers 1 through 10. Here $f(t)$ are to be defined either empirically (one data card for every time step), or using the modeling of TACS, or in FORTRAN by means of a user-supplied subroutine "ANALYT". Details are covered in Section 1.9. Should only control by TACS be desired, use of Type 60-99 provides an alternative.

TYPE = 11:

$f(t) = \text{AMPLITUDE}$, which is an approximate step function in the case of zero initial condition $f(0) = 0$ or a dc source in the case of initial condition $f(0) = \text{AMPLITUDE}$.

The step function is approximate in the sense that linear interpolation between discrete points produces a finite rise time Δt (see figure).

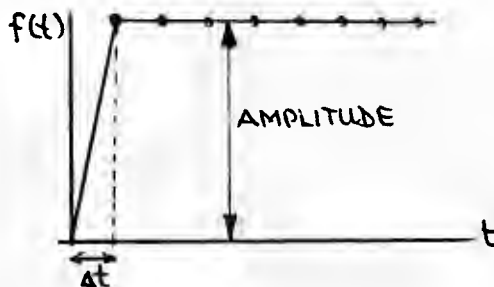

If initial condition $f(0) = \text{AMPLITUDE}$, then this type is a dc source (see figure).

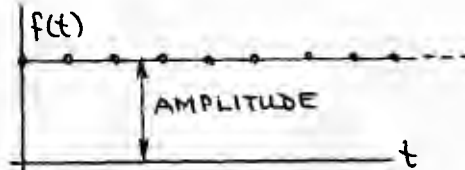

TYPE = 12: Ramp function with linear rise from $t = 0$ to $t = T_0$ and constant amplitude thereafter (see figure, drawn for $f(0) = 0$).

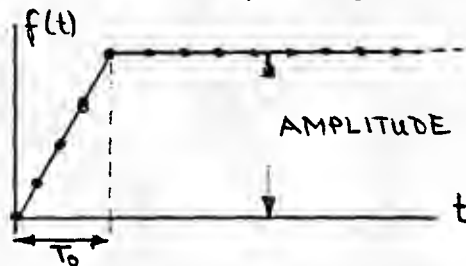

TYPE = 13: Ramp function with linear decay (see figure, drawn for $f(0) = 0$) or with linear rise if $A_1 > \text{AMPLITUDE}$. The special case $T_0 = 0$ is permitted.

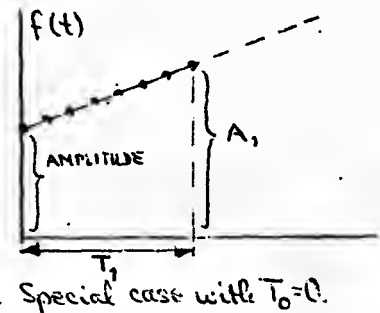
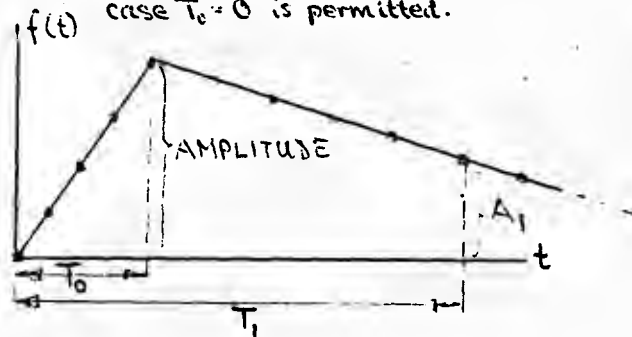

TYPE = 14: Sinusoidal function (see figure, drawn for $f(0) = 0$).

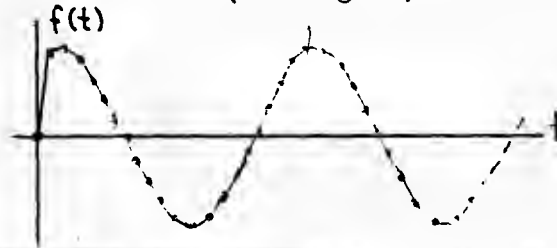

Two options are available. If

$$A_1 = 0: f(t) = \text{AMPLITUDE} * \cos(2\pi f \cdot t + \phi_0)$$

with $f = \text{FREQUENCY}$
 ϕ_0 in degrees

$$A_1 > 0: f(t) = \text{AMPLITUDE} * \cos[2\pi f(t + T_0)]$$

with $f = \text{FREQUENCY}$
 T_0 in seconds.

Note: For consistency, the user should specify all sinusoidal amplitudes as peak rather than as RMS values. Unless this is done, the power flow and loss figures of the complete steady-state phasor solution printout (see Section 1.0h; "KSSOUT" punched as "1" in column 32 of the integer misc. data card) will be only half of the correct values.

- TYPE = 15 : Surge function $f(t) = \text{AMPLITUDE} * (e^{\alpha t} - e^{\beta t})$
Note that α and β are usually negative.
- TYPE = 16 : Special simplified representation of dc converter, as seen from the dc side. See Section 1.61 for details.
- TYPE = 17 : Used to connect a TACS-generated modulating signal (a multiplying factor) to the source immediately following. Only columns 1-8 are punched, with the 6-character TACS variable name in cols. 3-8. This is only for the time-step loop (Type-17 sources are ignored for the phasor steady state solution). See Ref. 8, Vol. XI, 6 February 1982, page ECEO-14, where the source began (as Type 18).
- TYPE = 18 : Used to represent a combined ideal transformer and voltage source (possibly ungrounded), as shown in the sketch. For an ungrounded voltage source only, set the turns ratio "n" equal to zero. For an ideal transformer only, set the source amplitude almost to zero. The theory behind this modeling was first exposed in Ref. 22, Vol. 2, No. 4, Section II-C, page 41 (then called the Type-19 source of Fig. 4). The voltage source itself is defined on a preceding, conventional source card, which must be immediately followed by the Type-18 card that contains only the type code ("18"), four node names, and a turns ratio:

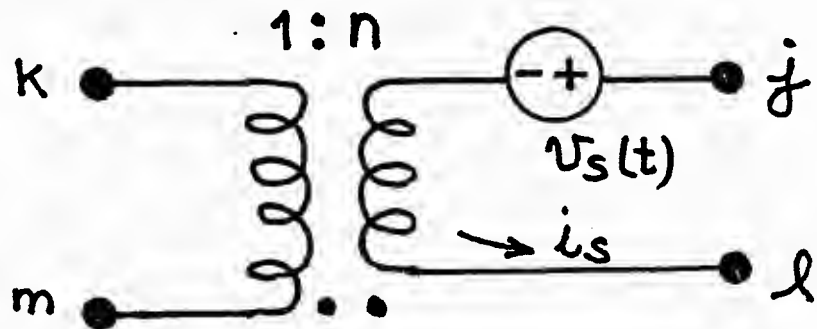

- node "j" ---- A6 name in cols. 3-8 of preceding source card;
node "L" ---- A6 name in cols. 3-8 of Type-18 card;
node "k" ---- A6 name in cols. 21-26 of Type-18 card;
node "m" ---- A6 name in cols. 27-32 of Type-18 card;
ratio "n" --- E10.0 number in cols. 11-20 of Type-18 card;
node "X" ---- A6 name in cols. 33-38 of Type-18 card. This is an extra, fictitious node which has voltage equal to the current of the source and/or transformer. Node voltage output can be used to display this current (printing or plotting).

TYPE = 19 : Request card which announces that all universal machine (U.M.) data cards for this data case follow. The rest of the data card (cols. 3-80) can be blank. See Section 1.63 for documentation of the U.M. data.

TYPE = 50 Three-phase dynamic synchronous machine component, the data
51 format and details of which are fully documented in Section 1.62 .
etc. :

59

TYPE = 60 These are special slave sources, reserved for connection to (control by) TACS variables. TACS dynamics are fully described in Section 8. . Source values are automatically set equal to the TACS variables having the same 6-character names. Columns 11-60 of the source card are not used, and can be left blank. Type-60 sources are limited in number only by List 4 dimensioning.

Unlike the TACS control of Type 1-10 EMTP sources (see Section 1.9a), here the interface is established automatically; there is no need for any specification like the "TACS EMTP SOURCES" card of Section 1.0g2 . On the other hand, the Type 1-10 sources are somewhat more flexible (note in particular that the controlling TACS variables could have arbitrary names, for Type 1-10 sources).

- 5) Sinusoidal ac steady-state conditions are automatically computed as initial conditions for the transient phenomena. Simply punch $TSTART < 0$ on all source cards of TYPE 14 which are active in the steady-state. Note that only sinusoidal functions (TYPE 14) are considered as potential steady-state sources. The first source card encountered with TYPE = 14 and $TSTART < 0$ will determine the steady-state frequency f_{ac} ; all other sources with TYPE = 14 and $TSTART < 0$, whose frequency does not deviate from f_{ac} by more than one percent, will also be included in the steady-state solution^{ac} (with their frequency set to f_{ac}).

If steady-state conditions are desired for dc, treat dc as a sinusoidal function with very low frequency ($f(t) = \cos 2\pi ft$ with f very low) or read in initial conditions (section 1.7). See footnote on p. 35.

To place trapped charge on a disconnected transmission circuit (and associated, isolated components), use a current source ("-1" in columns 9 and 10), a low sinusoidal frequency, and $Tstart = 5432.0$ in cols. 61-70. With the normal EMTP logic, this ensures that the source will not be present for the time-step loop, since a zero current source (one never started) in effect does not exist. As for the steady-state phasor solution, we now internally trick the EMTP into treating this source as a voltage source (as though $Tstart = -1.0$ and columns 9-10 had been blank). More documentation on this usage can be found in Ref. 8, Vol. XI, 5 August 1981, Pages MSPR-8 and 9. The only extra temporary complication is for degenerate problems: make sure at least one regular phasor source is present (if not, add a dummy one with $Tstart$ negative).

- 6) For a delayed start of a source function, use $TSTART > 0$. Then $f(t) = 0$ for $t < TSTART$ (not disconnected) and $f(t)$ as specified as soon as $t \geq TSTART$. Note that the time count for the source function starts with $TSTART$ (see figure) if $TSTART > 0$. Negative $TSTART$ is set to 0 by the program, except for TYPE 14 where it is used to indicate steady-state sources with the time count starting at $t = 0$.

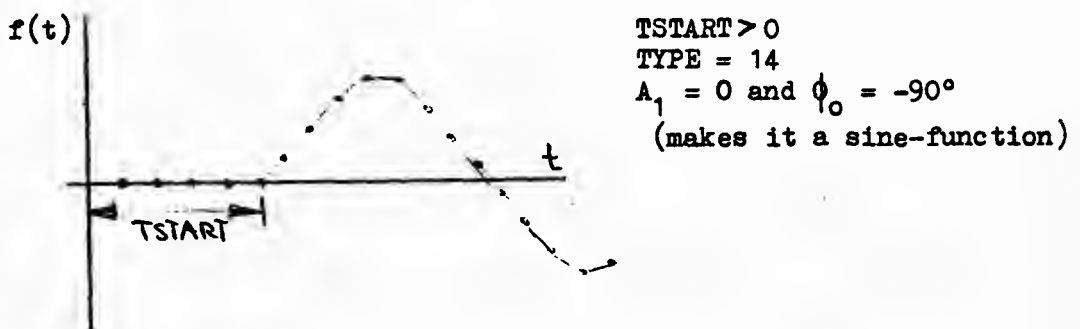

- 7) For nullification of a source function after $t > TSTOP$ use the appropriate $TSTOP > 0$. Then $f(t) = 0$ as soon as $t \geq TSTOP$ (not disconnected). $TSTOP = 0$ or blank will be interpreted to mean $TSTOP = \text{infinity}$.

- 8) Composite functions, which are composed of pieces of available function types, can be produced by using TSTART and TSTOP.

Example:

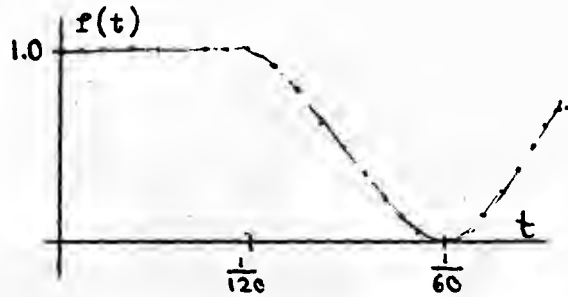

initial condition $f(t) = 1.0$

Three source cards:

1st card: TYPE = 11, AMPLITUDE = 1.0 TSTART=0
TSTOP = 1/120

2nd card: TYPE = 11, AMPLITUDE=0.5, TSTART=1/120
TSTOP=blank

3rd card: TYPE = 14, AMPLITUDE = 0.5,
FREQUENCY = 60, $A_1=0$, $\phi_0 = 0$,
TSTART = 1/120, TSTOP = blank

Source type 13 with the appropriate parameters TSTART and TSTOP can be used to simulate piecewise linear functions:

Example:

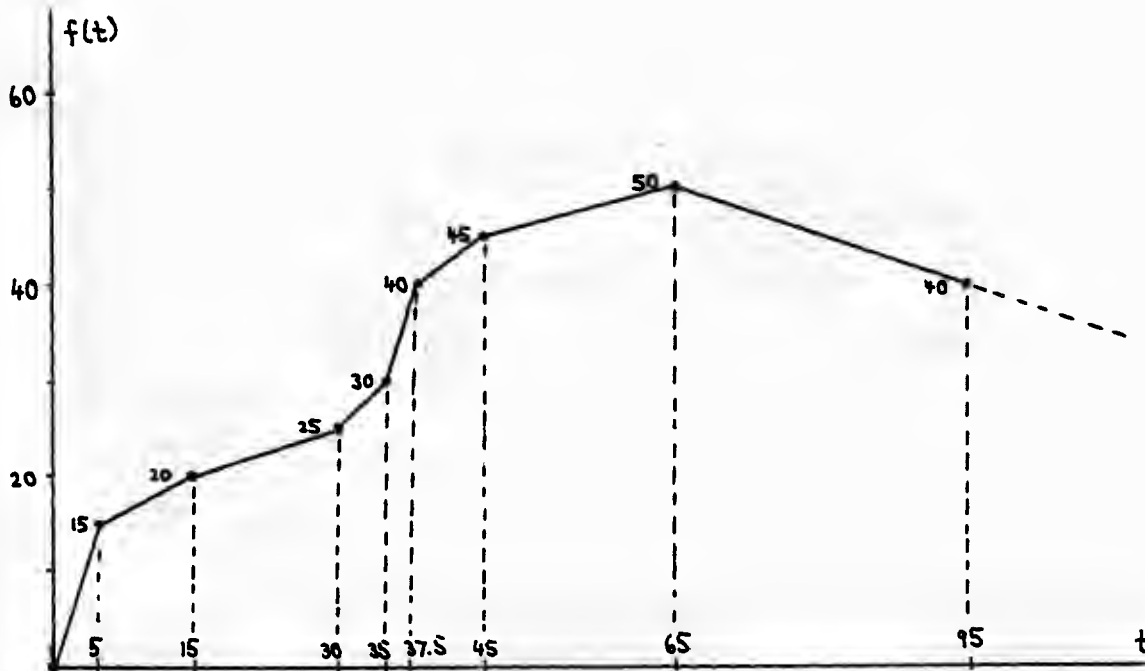

Use 7 source cards (first 2 slopes are simulated with one card):

	TYPE	AMPLITUDE	T_0	A_1	T_1	TSTART	TSTOP
1st card:	13	15	5	20	15	0	15
2nd card:	13	20	0	25	15	15	30
3rd card:	13	25	0	30	5	30	35
4th card:	13	30	0	40	2.5	35	37.5
5th card:	13	40	0	45	7.5	37.5	45
6th card:	13	45	0	50	20	45	65
7th card:	13	50	0	40	30	65	"blank"

9) For sources which are not grounded at one end, two tricks are available, as follows:

a) Current sources require only a duplication, with the desired source from k to m replaced by one from k to ground and a second one from m to ground:

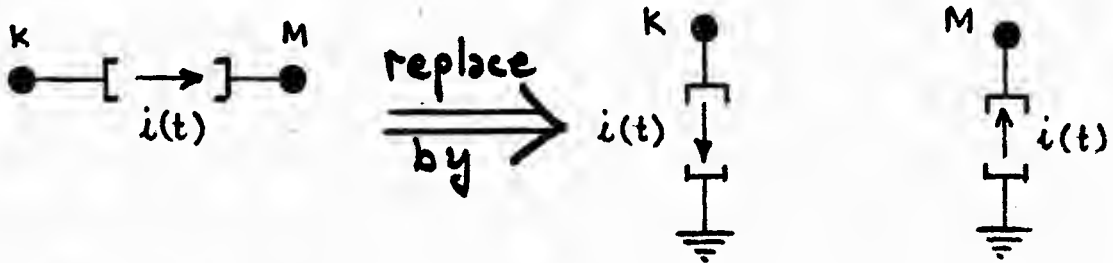

b) Voltage sources can be handled by first converting to equivalent current sources, provided that the voltage sources have some series impedance (which will always be true, physically). This amounts to finding the Norton equivalent of the original voltage source and impedance. Having done this, the current source in question is handled as per Point a) above.

Example: Consider the modelling of a 3-phase generator which is Wye-connected, but ungrounded, as per the sketch. Decoupled series source inductances $L \neq 0$ are assumed. The Norton equivalent of each phase is then found symbolically as follows, using Laplace transforms:

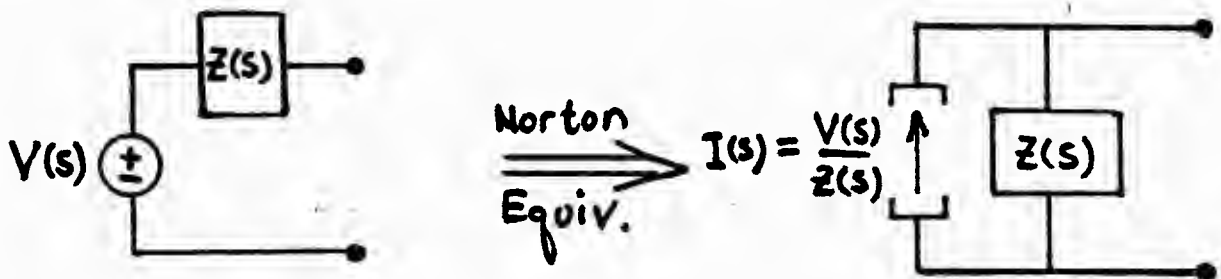
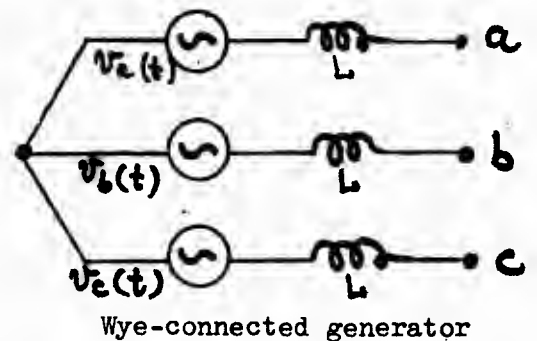

Assuming $v(t) = V_0 \sin(\omega t)$ for concreteness, we have the following calculations: $V(s) = \omega V_0 / (s^2 + \omega^2)$

$$Z(s) = sL, \text{ so}$$

$$I(s) = \frac{V_0}{\omega L} \left[\frac{\omega^2}{s^2 + \omega^2} \right] = \frac{V_0}{\omega L} \mathcal{L} \{ 1 - \cos \omega t \}$$

$$i(t) = \frac{V_0}{\omega L} - \frac{V_0}{\omega L} \cos \omega t$$

1	2	3	4	5	6	7	8	9	10	11	12	13	14	15	16	17	18	19	20	21	22	23	24	25	26	27	28	29	30	31	32	33	34	35	36	37	38	39	40	41	42	43	44	45	46	47	48	49	50	51	52	53	54	55	56	57	58	59	60	61	62	63	64	65	66	67	68	69	70	71	72	73	74	75	76	77	78	79	80
W	NAME	VOLTAGE OR CURRENT	AMPLITUDE (ignored for type=1...10)	FREQUENCY in HZ (ignored if not type #14 or α for type #15)	T ₀ in degrees (ignored if type=1...11 or β for type #16)	A ₁ (ignored if not type #13 or 14)	T ₁ in s (ignored if not type #13)	TSTART in s (ignored if type=1...10)	TSTOP in s (ignored if type=1...10)																																																																						
I2	AG	I2	E10.6	E10.6	E10.6	E10.6	E10.6	E10.6	E10.6																																																																						
7	BUS-1	-1	-5																																																																												
10	BUS-2	-1																																																																													
11	BUS-3	-1																																																																													
12	BUS-4		1.2	60	.05																																																																										
14	BUS-5																																																																														
13	BUS-6		1			0.5	50.0E-6	-1	50.0E-6																																																																						

EXAMPLES:

BUS-1 is a node with voltage excitation whose value is read in from cards as the 7th value (columns 57-64) on the card,

BUS-2 is a node with current injection whose value is read in from cards as the 10th value (columns 73-80) on the card,

BUS-3 is a node with current injection $i(t) = -0.5$

BUS-4 is a node with voltage excitation of the following form:

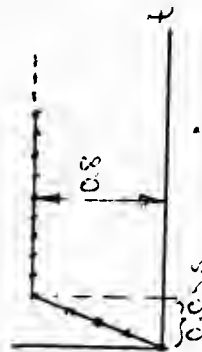

BUS-5 is a node with voltage excitation, present in the steady state and thereafter, $e(t) = 1.2 \cos(2\pi 60t - 0.06)$

BUS-6 is a node with voltage excitation of the following form:

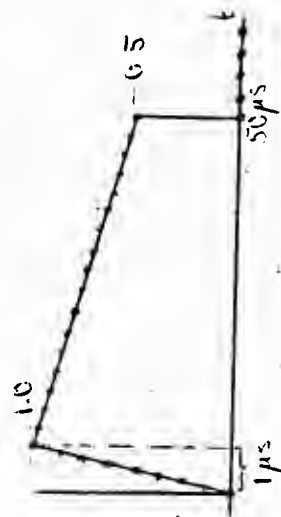

RULES:

- 1) Specify the source by type 16 on 2 cards (first card with node name for cathode side and parameters INITIAL, K etc., second card with node name for anode side and parameters k_1 , k_2 , etc.).

- 3) The steady-state initial conditions are automatically computed, with the d-c voltage source simulated as $e = e(0) \cdot \cos \omega t$ with $\omega = 2\pi f$ and $f = 0.001$ Hz. If the initial conditions are to be zero, simply set $e(0) = 0$. Depending on the value of INITIAL,

$$\begin{aligned} e(0) &= e_{\text{INITIAL}} && \text{if INITIAL} = 1 \\ e(0) &= e_{\text{max}} && \text{if " } = 2 \\ e(0) &= e_{\text{min}} && \text{if " } = 3 \end{aligned}$$

If the value of INITIAL is less than 1 or greater than 3, then an error message is printed "ERROR IN IDENTIFICATION OF SOURCE".

The initial current i_{INITIAL} must be given by the user because the voltage source has an internal resistance in series in the transients program (its value is printed in the record of source data as EQUIV. RESISTANCE). This equivalent resistance results from the transformation of the differential equations to difference equations with the trapezoidal rule of integration. The program then sets $e_{\text{SOURCE}} = e(0) + R_{\text{EQUIV}} \cdot i_{\text{INITIAL}}$. If the initial current is wrong, then the initial voltage at the terminals will not be exactly $e(0)$; this error may or may not be negligible depending on whether $|R_{\text{EQUIV}} \cdot i_{\text{INITIAL}}| \ll |e(0)|$ or not. Note that i_{INITIAL} is only used for the compensation just mentioned and for nothing else. If $i_{\text{INITIAL}} < 0$, then it is set to zero internally in the program.

- 4) The value I_{BIAS} in Eq. (2) is automatically computed after return from the steady-state subroutine. With e_{SOURCE} as defined in rule 3, the steady-state current $i(0)$ is automatically obtained. Note that this $i(0)$ may differ from i_{INITIAL} if the latter was not given correctly, except if the user specifies $i_{\text{INITIAL}} = 0$. In this case, $i(0)$ will also be zero because the switch which simulates the diode effect would be kept open for the steady-state solution. I_{BIAS} is then computed from

$$e_{\alpha}(0) = K \cdot (I_{\text{BIAS}} - i(0)) \quad \text{if INITIAL} = 1, \quad (4)$$

$$\text{or } e_{\alpha}(0) = K \cdot (I_{\text{BIAS}} - i_{\text{SETTING}}) \quad \text{if INITIAL} = 2 \text{ or } 3. \quad (5)$$

Eq. (5) is used if the steady-state voltage was at its minimum or maximum limit; in this case, the current setting i_{SETTING} is assumed to be the value where the control would begin to back off the limit again.

5) Output options for printing and/or plotting:

Punch "1" in col. 80 on card for ANODE side	to get branch current,
"2" " " " "	to get branch voltage,
"3" " " " "	to get both.

- 6) Spurious voltage oscillations may occur at the terminal after current extinction unless damping circuits are also modeled. Dr. W. Long of Hughes Research Laboratories obtained good results by adding a RC branch between anode and cathode ($R=900\ \Omega$, $C=0.15\ \mu\text{F}$). Bill is now (1977) with the University of Wisconsin in Madison, Dept. of Electrical & Computer Engineering.
- 7) Data field R_{ϵ} of columns 51-60 of the anode source card is used to specify the resistance in ohms of a small series isolation resistor which is defined internally by the program. In the following diagram showing internal EMTP representation of the type-16 source component, the resistor in question is that between the user-supplied anode node name "BUS1" and the internally-defined node "TYP-16" :

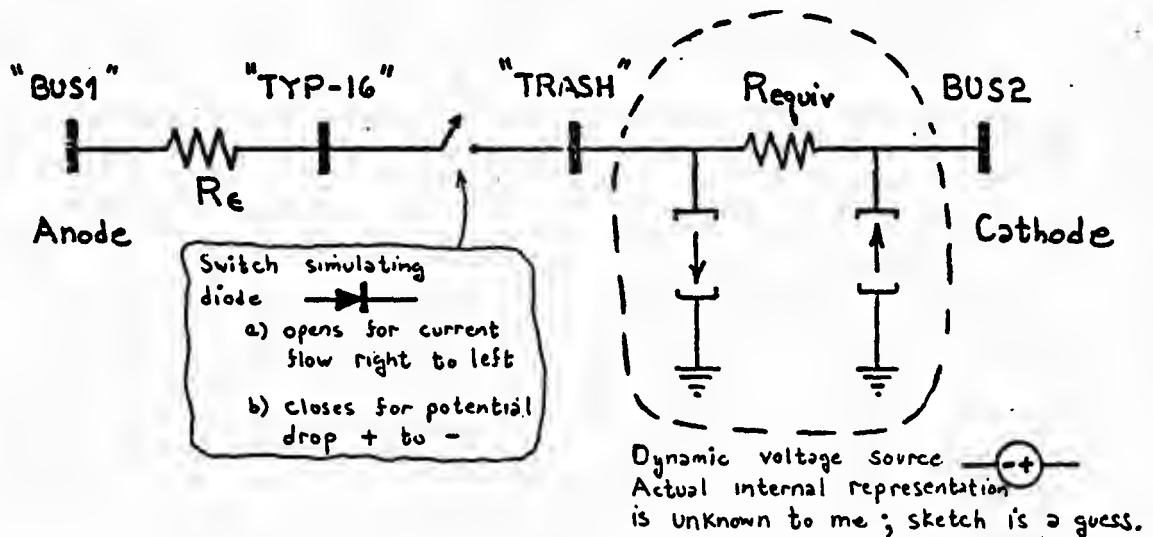

See the EMTP memorandum dated November 19, 1975 (Reference 8), as to the reason for this isolation branch. If field R_{ϵ} is left blank (or punched with the value 0.0), the EMTP will automatically supply a default value equal to the square root of "EPSLN", where "EPSLN" is a floating-point miscellaneous data parameter (see Section 1.0h). A column-80 (data field "IOUT") request for current output will be internally converted into a current-output request for resistor R_{ϵ} , and it will show up this way in the printed column headings which precede the transient printout; a column-80 request for branch-voltage output will produce the voltage difference from anode to cathode. Both node names TRASH = "....." and "TYP-16" are reserved for internal definition by the program. These names should never be used for anything else by the user.

1.62 THREE-PHASE DYNAMIC SYNCHRONOUS MACHINE SOURCE COMPONENT

Before describing what is involved in this section, let me first briefly mention what is not involved. If the dynamics of Parks's equations are not wanted, power system generators are typically represented by sinusoidal voltage sources (Type-14 source of Section 1.6). If the rotating machine is not a conventional, balanced three-phase synchronous generator, the user is referred to the universal machine (U.M) modeling of Section 1.63.

TYPE-59 DYNAMIC SYNCHRONOUS MACHINE SOURCE COMPONENT

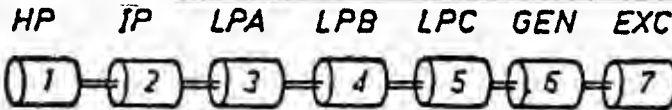
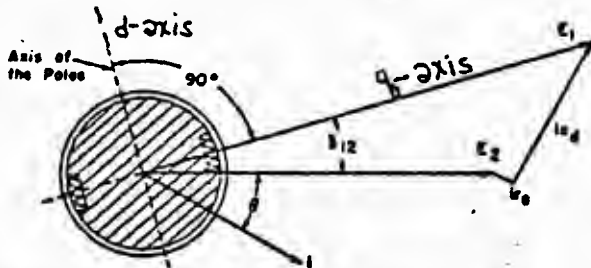

Fig. 3 Model of turbine-generator unit



General Description of Component

Mathematics of the Type-59 dynamic synchronous machine source component (an EMTP source by general classification) were developed at the University of British Columbia in Vancouver as part of the doctoral research of Dr. Vladimir Brandwajn, conducted under the supervision of Prof. Hermann W. Dommel. The theory is fully documented in Vladimir's Ph.D thesis (Ref. 15), and Ref. 20 provides a shorter summary. Actual implementation and enhancement in the EMTP was performed under contract with BPA, as documented in Ref. 8, Vol. VII, 23 December 1977, pagination CBVB.

Over the years, the code was subject to extensive modifications which were aimed at improving its reliability and flexibility [EMTP Newsletter]. For example, the original fixed dimensioned structure was removed in January, 1984. Some parts of the original algorithm were also modified. In particular, the prediction of variables was significantly changed so as to produce respectable improvements in the numerical stability of the algorithm.

The dynamic S.M. component is internally balanced (with respect to the armature phases), and is inherently three-phase. The windings are assumed to be Wye-connected, with a possible R-L branch between the neutral and local ground.

For output purposes, most machine parameters of interest are available: velocities and angles of the rotor masses, inter-mass shaft torques, winding currents, and certain d-q-o variables. Such output quantities are automatically appended to the end of the regular EMTP output vector upon the request of the user, and hence are available for printing and plotting just like any other EMTP variable.

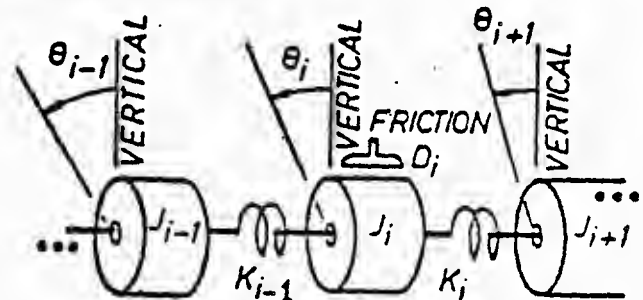
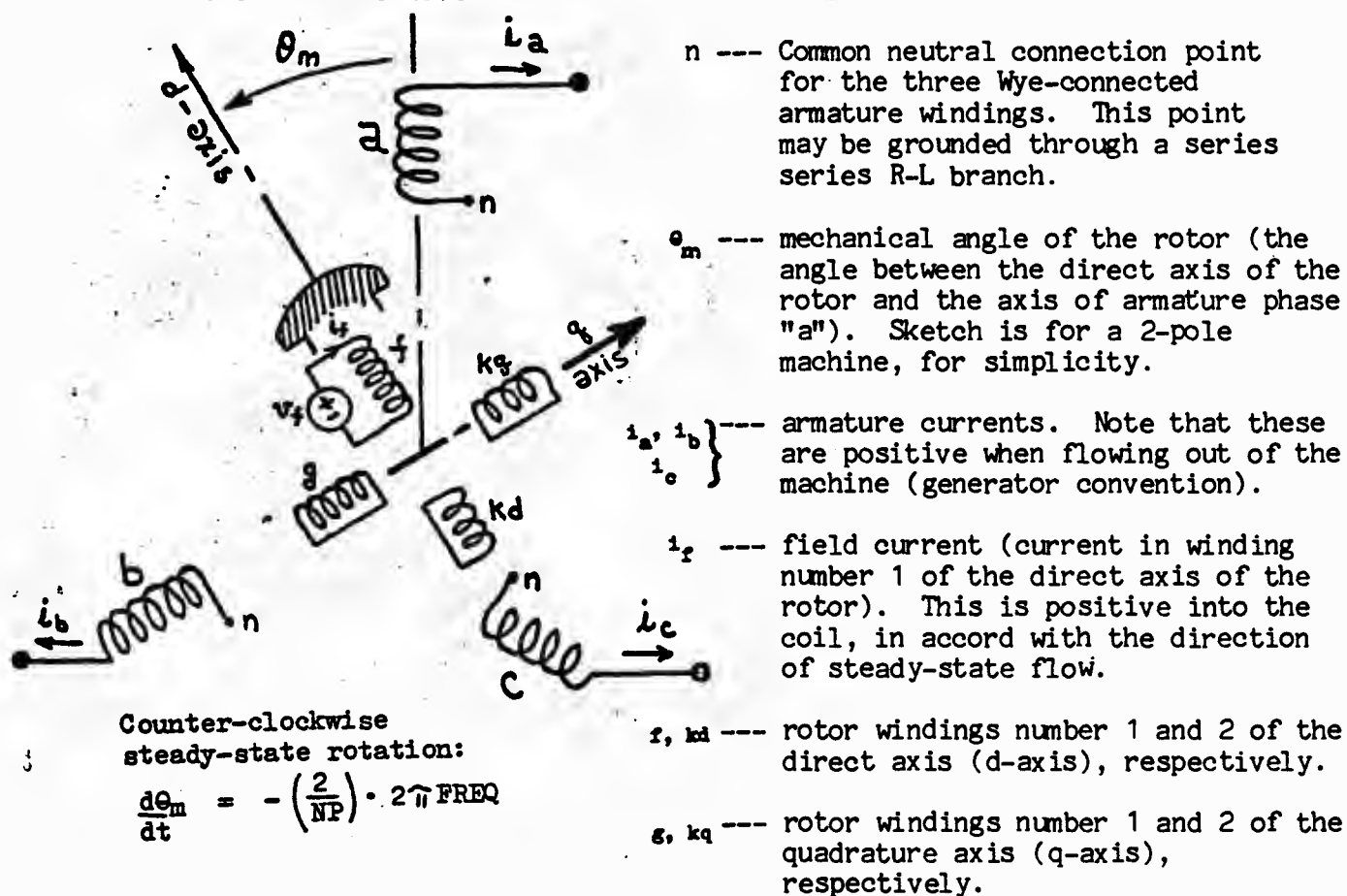

Fig. 4 Turbine-generator part around mass i

Each rotor mass is allowed to have a constant mechanical power applied to it (in addition to the torque of mechanical viscous damping and the spring connection to adjacent masses). The user specifies proportionality factors for each mass, with the actual constant power then determined internally by the ETP at the time of the sinusoidal steady-state initialization (so as to produce equilibrium). This is the basic scheme regarding mechanical input torque, in the absence of special connections. But the user is allowed to represent prime mover (e.g., governor, boiler, etc.) dynamics if he so chooses, by using TACS (see Section 8.) to control the just-described total mechanical power. In this case, the required TACS output variable is a normalized multiplicative constant (equal to unity if it is to produce no effect) for scaling the otherwise-constant mechanical power. Should the user desire a constant-torque representation of the prime mover, this can be readily provided by the TACS connection (TACS would divide the steady-state speed by the instantaneous speed to produce the required control signal).

Even without any detailed explanation of where they come from, it might be desirable to document the set of equations which is used to model the S.M. We have:



Notes about mechanical equation (see lower right-hand corner of next page)

- 1) Coefficient names are as defined in the section about Class 4 S.M. data cards
- 2) This equation is Newton's law in rotational form for mass number "k", assuming the most general case.
- 3) If case number "k" is not the generator rotor, omit the electromechanical torque T_{em} .

- 4) If mass number "k" is at one end of the shaft system, either mass number k-1 or mass number k+1 (or both, in the case of a single mass system) will not exist. In this case, the associated terms of mutual coupling ("DSM" AND "HSP") are defined to be zero.
- 5) The synchronous mechanical frequency "f" enters only through the speed-deviation self-damping term.
- 6) As used here, θ_k is the absolute angle of mass number "k" of the shaft system.
- 7) T_k^{mech} is the externally-applied mechanical torque on mass number "k", in the direction of $+\theta$.

Data Format for Dynamic Synchronous Machine

The specification of a dynamic synchronous machine source component within an EMTF data case requires a number of data cards. These shall now be described in order of data input, in groups, according to the following classification:

Class 1 S.M. data cards

First come three cards which specify the component type code, the voltage magnitude and angle in the steady-state, and names for the network nodes to which the armature windings are to be connected. The first of these 3 cards is for phase "a", as per the following format:

ITYPE	BUS	VOLT	FREQ	ANGLE
12	A6	E10.6	E10.6	E10.6

ITYPE ---- Type code for the dynamic synchronous machine component.
Punch ITYPE = 59 .

BUS ---- Six-character EMTF network node name, punched in columns 3-8 as A6 information. The armature winding of phase "a" is to be connected to this node of the electric network.

VOLT ---- The steady-state voltage magnitude at the terminals of the machine. This is peak voltage (1.414 times RMS), line to neutral (.577 times line-to-line). Use units of [volts] .

FREQ ---- The electrical frequency of the generator in Hz, for steady-state operation. For North American systems, this will be 60.

ANGLE ---- The steady-state voltage phasor angle at the terminals of the machine, for phase "a". Units are degrees. This machine component, all other ones, and all sinusoidal voltage or current sources of Type 14 are assumed to all have the same reference for phase angles, of course.

Conventional positive sequence is assumed, as this term is used in North America. That is, phase "b" voltage lags phase "a" voltage by 120 degrees (and "c" leads "a" by 120 degrees). See sketch.

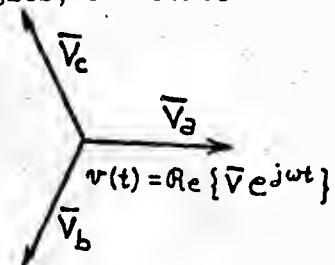

$$\begin{aligned}
 v_d &= -R_a \dot{i}_d - \frac{d\lambda_d}{dt} - \lambda_f \frac{d\theta}{dt} \\
 v_f &= -R_a \dot{i}_f - \frac{d\lambda_f}{dt} + \lambda_d \frac{d\theta}{dt} \\
 v_o &= -(R_a + 3R_n) \dot{i}_o - \frac{d\lambda_o}{dt} \\
 v_f &= -R_f \dot{i}_f - \frac{d\lambda_f}{dt} \\
 0 &= -R_g \dot{i}_g - \frac{d\lambda_g}{dt} \\
 0 &= -R_{kd} \dot{i}_{kd} - \frac{d\lambda_{kd}}{dt} \\
 0 &= -R_{kg} \dot{i}_{kg} - \frac{d\lambda_{kg}}{dt}
 \end{aligned}$$

$$\pi_{em} = \frac{NP}{2} (\lambda_d \dot{i}_f - \lambda_f \dot{i}_d)$$

λ_d	λ_f	λ_o	λ_f	λ_g	λ_{kd}	λ_{kg}
λ_d	λ_f	λ_o	λ_f	λ_g	λ_{kd}	λ_{kg}
λ_d	λ_f	λ_o	λ_f	λ_g	λ_{kd}	λ_{kg}
λ_d	λ_f	λ_o	λ_f	λ_g	λ_{kd}	λ_{kg}
λ_d	λ_f	λ_o	λ_f	λ_g	λ_{kd}	λ_{kg}
λ_d	λ_f	λ_o	λ_f	λ_g	λ_{kd}	λ_{kg}
λ_d	λ_f	λ_o	λ_f	λ_g	λ_{kd}	λ_{kg}

=

λ_d	λ_f	λ_o	λ_f	λ_g	λ_{kd}	λ_{kg}
λ_d	λ_f	λ_o	λ_f	λ_g	λ_{kd}	λ_{kg}
λ_d	λ_f	λ_o	λ_f	λ_g	λ_{kd}	λ_{kg}
λ_d	λ_f	λ_o	λ_f	λ_g	λ_{kd}	λ_{kg}
λ_d	λ_f	λ_o	λ_f	λ_g	λ_{kd}	λ_{kg}
λ_d	λ_f	λ_o	λ_f	λ_g	λ_{kd}	λ_{kg}
λ_d	λ_f	λ_o	λ_f	λ_g	λ_{kd}	λ_{kg}

34f-1

$$\vec{y}_{coil} = \begin{pmatrix} y_a \\ y_b \\ y_c \end{pmatrix} \quad \vec{y}_{park} = \begin{pmatrix} y_d \\ y_f \\ y_o \end{pmatrix}$$

$$\vec{y}_{park} = [S] \vec{y}_{coil}$$

$[S]^{-1} = [S]^t$ (orthogonal)

$\cos(\theta)$	$\cos(\theta - \frac{2\pi}{3})$	$\cos(\theta - \frac{4\pi}{3})$
$\sin(\theta)$	$\sin(\theta - \frac{2\pi}{3})$	$\sin(\theta - \frac{4\pi}{3})$
$1/\sqrt{2}$	$1/\sqrt{2}$	$1/\sqrt{2}$

$$[S] = \sqrt{\frac{2}{3}}$$

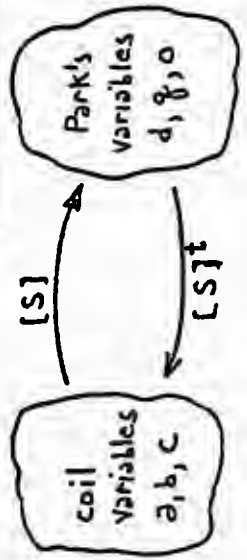

$$\begin{aligned}
 &HJ_k \frac{d^2\theta_k}{dt^2} + 0_k \frac{d\theta_k}{dt} + DSR_k \cdot \left(\frac{d\theta_k}{dt} - \omega \pi f \right) \\
 &+ DSM_{k,k+1} \cdot \left(\frac{d\theta_k}{dt} - \frac{d\theta_{k+1}}{dt} \right) + DSM_{k-1,k} \cdot \left(\frac{d\theta_k}{dt} - \frac{d\theta_{k-1}}{dt} \right) \\
 &+ HSP_{k,k+1} \cdot (\theta_k - \theta_{k+1}) + HSP_{k-1,k} \cdot (\theta_k - \theta_{k-1}) = \pi_{mech} - \pi_{em}
 \end{aligned}$$

The 2nd and 3rd cards in Class 1 use the same format described above:

ITYPE --- Blank.

BUS ----- Six character EMTP network node name. The appropriate armature winding (phase b or c) is to be connected to this node.

VOLT ----- The steady-state voltage magnitude at the above named SM terminal (network node). Use units of volts.

FREQ --- Blank.

ANGLE ----- The steady-state voltage phase angle at the above named SM terminal. Units are degrees.

If the values of VOLT and ANGLE on cards No 2 and 3 are not specified (left blank), the program assumes the presence of a 3-phase balanced source at the SM terminals. Otherwise, the presence of an unbalanced 3-phase source is assumed. This allows the user the specification of unbalanced S.S. conditions.

Class 2 S.M. data cards

Next in order of data input come optional special-request cards (if any) which are associated with the machine. There are 3 such possible cards, with format and meaning as described immediately below. Ordering of such cards (if two or more) within the Class 2 grouping is arbitrary.

a) "TOLERANCES" special-request card **

TOLERANCES	E10.0	E10.0	E10.0		I10
	EPSUBA	EPOMEG	EPOMEG		NIOMAX

EPSUBA - Number specifying the ratio between the built-in damping resistors and the resistive models of the inductive elements paralleled by these resistors, i.e., the following relationship holds true for each inductive element:

$$EPSUBA = \frac{R_p}{(\omega L / \Delta t)}$$

Should the columns 11-20 are left blank, a default value of EPSUBA = 100.0 would be assigned. The choice of the above shown default value is based upon the analysis presented in EMTP Newsletter, Vol. 3, No. 2, Nov., 1982, pp. 22-27.

For the, hopefully, rare cases of numerical instability, the recommended value is 20.0-50.0.

EPOMEG --- Tolerance associated with the iterative calculation of S.M. rotor speed at each time-step of the simulation.

The calculation is assumed to have failed when the relative speed correction is greater than this tolerance after NIOMAX iterations. The program execution is then terminated with an appropriate error message.

** Only non-blank (non-zero) fields of the 'TOLERANCES' card serve to redefine the built-in default values.

- EPDGEL -- Tolerance associated with the iterative calculation of S.M. rotor speed at each time-step. The calculation is assumed to have converged when the relative speed correction is less than this tolerance. If the relative speed correction is larger than this tolerance but smaller than EPOMEG, the solution is assumed to have converged marginally and an appropriate warning is printed.
- NIOMAX --- Maximum number of iterations which are allowed for the calculation of the S.M. rotor speed, at any time-step (default NIOMAX = 10).

It should be stressed that these are scalar variables only; they apply to the entire data case (all machines) rather than to the specific machine along with which they were defined.

The built-in default values are acceptable for double-precision (60 bits and more) calculations*. For lower-precision computers (UNIVAC, HONEYWELL etc.), the following values were recommended:

EPDGEL = 1.E-5
 EPOMEG = 1.E-4
 NIOMAX = 10

- * A full iterative solution of the type 59 SM is not possible and, consequently, the iterations are used for only minor adjustments of the calculations. There are, therefore, only minor benefits to be derived from applying very tight convergence criteria.

b) "PARAMETER FITTING" special-request card

The PARAMETER FITTING card is used to distinguish between different types of data. The presence of this card signals manufacturer's data, while its absence indicates the use of per unit inductances and resistances. Depending upon the value of FM, the EMTP logic will select either the simplified procedure or attempt to optimize the machine parameters.

1	2	3	4	5	6	7	8	9	10	11	12	13	14	15	16	17	18	19	20	21	22	23	24	25	26	27	28	29	30	31	32
PARAMETER FITTING																								E8.0		FM					

Commonly available S.M. test data turns out to actually be inefficient by itself to uniquely specify all parameters of the mathematical model (Park's equations) which is used by the EMTP. In the past, a simplified set of additional linear constraints has implicitly been added, thereby completing the parameter assignment.

Documentation of the mathematics used for parameter optimization is contained in Ref. 14; the procedure is explained in greater detail in Sections 2.3 and 2.4 of Reference 15, pages 12-18. For most EMTP users, however, such detailed machine considerations are too involved to be studied and understood in detail. Hence the only explanation presented here shall be a reproduction of the Abstract of Reference 14:

The conversion of measurable machine parameters into resistances and self and mutual inductances needed for the computer model is presented. The commonly used, simplified set of equations is replaced by a set of more accurate, non-linear equation. While the differences between parameters found from the accurate and approximate relationships are not great for typical machine parameters, the method does avoid the uncertainty associated with approximations, which do not really have to be made any more. The method does not require any additional test data, but they may be easily incorporated, when available. The effects of saturation on the inductances are briefly discussed.

Preliminary experiments seem to indicate that armature currents and voltages, plus mechanical quantities on the shaft system, are only affected in a very minor way, typically but rotor electrical quantities, and specifically the field current, may be significantly affected (ten to twenty per cent or more).

The parameter optimization involves the iterative solution of a set of nonlinear equations by Newton's method. The initial (starting) guess is taken to be the values as produced by simplified historical approximation. If so requested by the user (in terms of the numerical parameter values which he actually inputs), the fitting process may be performed twice for each generator --- once for the direct axis, and once for the quadrature axis. If the original machine parameters are unrealistic, the iteration may not converge, and a warning message to this effect will be printed (see message number 47 of Section 2.2b). Nothing is lost in this case, however, since the EMTP will recover, and will simply use the input data without any optimized adjustment. Preliminary experimentation would seem to indicate that convergence will most probably occur for cases in which the following parameter relationships apply:

$$T'_{dc} > 10 T''_{do} \quad T'_{do} > 10 T''_{do} \quad X''_d > 1.3 X_L \quad X''_q > 1.3 X_L$$

It is here assumed that unsaturated parameter values are used, and the factors of 10 and 1.3 are sort of empirical estimates.

If standard manufacturer data is being used, then there are several different cases of interest:

Case 0: To disable the parameter optimization, punch value 2.0 for "FM".

Case 1: If the user has a valid full set of S.M. data parameters (i.e., full transient and subtransient data which is not somehow degenerate), then usage of parameter optimization is optional; if used, "FM" should always be given a value of unity (FM = 1.0).

Case 2: If the user has data in which $X'_q = X_q$ and $T'_{dc} \neq T'_{do}$, such parameters can be shown to be inconsistent. There are two options available to the EMTP user who punches data that satisfies such conditions.

- a) If use is made of parameter "FM" somewhere in the range $.95 < FM < 1.0$, then the EMTP will use all q-axis coils. Internally, however, the constraint $X'_q = FM * X_q$ is observed (despite the user-punched equality of these two parameters).

- b) If use is made of parameter "FM" equal to unity (FM=1.0), then the q-axis damper winding is dropped from the model; this leaves just one q-axis coil.

Case 3: It is not uncommon for the user to have no data values for X'_{d0} and T'_{d0} . In this case, he can still run the simulation if he does three things to the data:

- 1) Use FM = 1.0;
- 2) Punch X'_{d0} equal to the known X_d value;
- 3) Set (punch) $T'_{d0} = 0.0$.

In this case, the EMTF will drop the q-axis damper winding from the model, leaving just one q-axis coil.

Case 4: Just like Case 2, only with "q" (referring to the quadrature axis) replaced by "d" (referring to the direct axis).

Case 5: Just like Case 3, only with "q" replaced by "d".

Case 6: If the user wants to model a machine without any dampers at all on the q-axis, he should punch a common value for X_d , X'_{d0} , and X''_{d0} .

c) "DELTA CONNECTION" special request card

If the armature windings of the dynamic S.M. are delta-connected (rather than Wye-connected), then this status must be communicated to the EMTF by a special-request card which bears the text "DELTA CONNECTION" in columns 1-16:



In the absence of such a card, the machine is assumed to be Wye-connected (which is by far the most common situation, for large power system generators). Except for the possible presence of this one special-request card, no other portion of the S.M. data specification explicitly makes reference to how the armature windings are connected.

For a machine the armature windings of which are delta-connected, a word about the interpretation of EMTF S.M. armature-current printout is in order. The labeling of variables is not altered (from that used for a Wye connection), so the user must be very careful. There are four situations, depending upon whether one considers initial conditions or time-step-loop printout, and whether coil variables or Park's variables. Of these four, two will be incorrectly labeled.

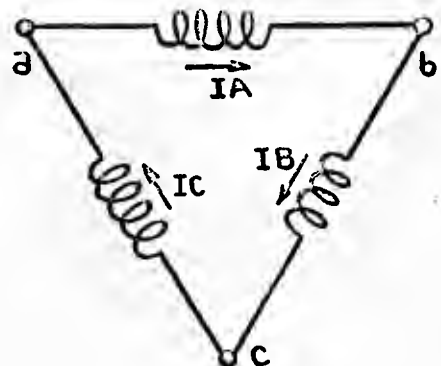

Fig. A. Erroneous initial-condition labeling, delta connection.

- 1) For the time-step-loop output, "ID", "IQ", and "IO" are indeed armature-winding variables (albeit in Park's coordinates). But "IA", "IB", and "IC" are erroneously labeled (see sketch), for they are

armature coil variables. E.g., what is labeled "IA" in the S.M. initial condition printout is actually i_{ab} , the current from "a" to "b" in the winding.

- 2) For the steady-state initial-condition output, the situation is identical to that in point 1).

Restriction: The option of "DELTA CONNECTION", when used for a multiple machine, applies to all machines connected to that bus. Consequently, it is not possible, to have a combination of Wye-connected and Delta-connected machines at the same bus. If such a rare configuration should ever arise, the user is required to isolate the machines by a small reactance or resistance.

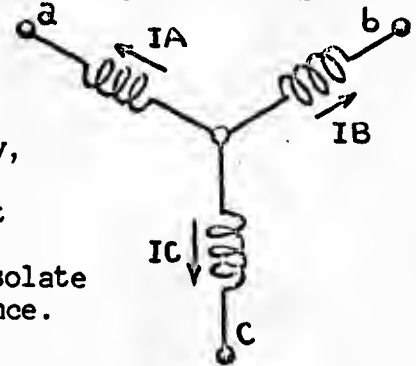

Fig. B. Conventional Wye labeling.

Class 3 S.M data cards

Next come either 4 or 5 cards, which specify the electrical parameters of the synchronous machine. The 1st of this group has the following format:

I2	NUMAS	I2	KMAC	I2	KEXC	I4	NP	SMOUTP	SMOUTQ	RMVA	RKY	AGLINE	S1	S2
I2	E10.6	I2	E10.6	I2	E10.6	I4	E10.6	E10.6	E10.6	E10.6	E10.6	E10.6	E10.6	E10.6

- NUMAS ---- The number of connected masses on the shaft system of this generator.
- KMAC ---- The mass number which corresponds to the generator (or motor) rotor, within the interconnected mass-spring shaft system. Masses are to be numbered by the user for identification, beginning with number one on either end, and continuing sequentially (2,3, ...) to the other end of the shaft. See Figs. 3 and 4 at the very beginning of Section 1.62.
- KEXC ---- The mass number which corresponds to the exciter on the shaft system. If no exciter exists, leave this field blank.
- NP ---- The number of poles (not pole pairs) which characterize the machine rotor. The electrical frequency of the machine is equal to the mechanical frequency times NP / 2, recall.
- SMOUTP --- Proportionality factor which is used only to split the real power among the generators constituting a multiple machine during the machine initialization. If a single machine, this field may be ignored. If a dual machine, suppose that the user punches value PA for this half of the dual, and value PB for the other half; then the fraction PA / (PA + PB) of the total steady-state real power output will be assigned to this half of the dual during machine initialization.

- SMOUTQ --- The same as "SMOUTP", only for reactive rather than real power.
- RMVA --- The total 3-phase volt-ampere rating of the machine, in units of MVA (million volt-amperes).
- RKV ---- The rated line-to-line voltage of the machine, in units of RMS kV. Taken as a pair, "RKV" and "RMVA" define the base values upon which per unit machine parameters are assumed to apply, it may be noted. Should the machine in question have a delta-connected armature, specify RKV as $\sqrt{3}$ times the rated winding voltage in kV RMS.

AGLINE ---- Value of the field current in amperes which will produce rated armature voltage (1.0 per unit) on the air gap line. This is an indirect specification of the mutual inductance between the field and the armature of the machine. See sketch below. If the S.M. is saturable, append an extra minus sign (making "AGLINE" negative) as a flag.

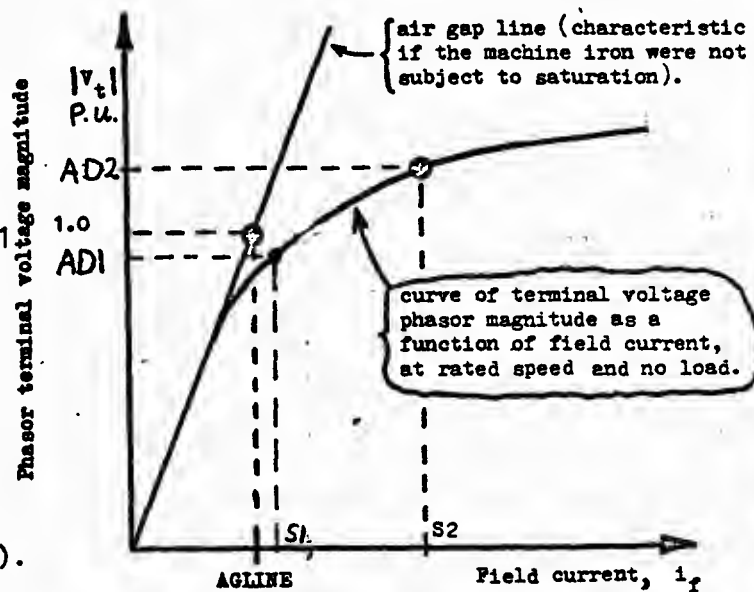

S1 --- Value of the field current in amperes which will produce AD1 *rated armature voltage (AD1 per unit) on the no-load saturation curve. See right. This field, as well as "S2", can be left blank if the S.M. is not saturable.

S2 --- Like "S1", only for AD2 of rated voltage (AD2 per unit).

The parameters "AGLINE", "S1", and "S2" just inputed actually apply to the d-axis of the machine. A second card follows --- call it Card 1a (as an extension of Card 1) --- to provide for the following parameters:

AD1	AD2	AQ1	AQ2	AG-Q	S1Q	S2Q
1.0	1.2	E10.6	E10.6	E10.6	E10.6	E10.6

If there is to be no saturation modeling at all, this card can be left blank.

- AD1 --- Per unit voltage at which current S1 was measured. Should this field be left blank, the default value of 1.0 will be automatically assigned.
- AD2 --- Like AD1, except for S2. Should this field be left blank, the default value of 1.2 will be automatically assigned.
- AQ1,AQ2 -- Like AD1 and AD2, but applied to the q-axis.
- AGLQ, S1Q, S2Q --- Like AGLINE, S1 and S2, but applied to the q-axis. Nonzero values of AGLQ indicate saturation as follows:

AGLQ > 0 : Here the q-axis air-gap line is known, and AGLQ is the value of the field current in amperes which will produce rated armature voltage on that line. Data fields "S1Q" and "S2Q" must not be left blank (supply correct values).

AGLQ < 0 : The negative value for AGLQ is a flag indicating that the user does not know the air-gap line for the q-axis. The EMTF will proceed to internally generate an approximate value, and use it for q-axis saturation modeling. In this case, "S1Q" and "S2Q" can be left blank, and -1.0 can be used for "AGLQ".

The remaining cards of Class 3 S.M. data depend upon whether standard manufacturer-supplied data are being used. If so ("PARAMETER FITTING" card was used), two additional cards having the following format complete the Class 2 data:

R_a	X_l	X_d	X_q	X'_d	X'_q	X''_d	X''_q
E10.6	E10.6	E10.6	E10.6	E10.6	E10.6	E10.6	E10.6
T'_{do}	T'_{qo}	T''_{do}	T''_{qo}	X_o	R_n	X_n	
E10.6	E10.6	E10.6	E10.6	E10.6	E10.6	E10.6	

R_a ----- Armature resistance, in per unit. This must be non-negative.

X_l ----- Armature leakage reactance, in per unit. If unknown, use 0.95 times the smallest of X''_d , X''_q , and X_o .

X_d ----- Direct-axis (d-axis) synchronous reactance, in per unit.

X_q ----- Quadrature-axis (q-axis) synchronous reactance, in per unit.

X'_d ----- Direct-axis (d-axis) transient reactance, in per unit.

X'_q ----- Quadrature-axis (q-axis) transient reactance, in per unit.

X''_d ----- Direct-axis (d-axis) subtransient reactance, in per unit.

X''_q ----- Quadrature-axis (q-axis) subtransient reactance, in per unit.

T'_{do} ----- Direct-axis (d-axis) open-circuit transient time constant, in seconds.

T'_{qo} ----- Quadrature-axis (q-axis) open-circuit transient time constant, in seconds.

- T''_{do} ----- Direct-axis (d-axis) open-circuit subtransient time constant, in seconds.
- $T''_{q'c}$ ----- Quadrature-axis (q-axis) open-circuit subtransient time constant, in seconds.
- X_0 ----- Zero-sequence reactance, in per unit. If this is unknown, it is suggested that the value of $X_l / .95$ be used. See note below.
- R_n ----- The real part of the neutral grounding impedance, in per unit. See note below.
- X_n ----- The imaginary part of the neutral grounding impedance, in per unit.

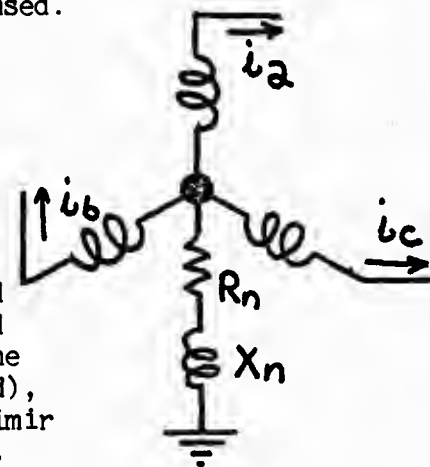

Note: The machine is assumed to have a Wye-connected armature, with the neutral connected to ground through the impedance $R_n + jX_n$. If the machine is in fact ungrounded (but still Wye-connected), simply use a large grounding impedance. Vladimir recommends 100 per unit or more, either R or X. (he has used both). This is done in Toronto, where Univac word length is only 36 bits.

On the other hand, should the user have chosen to describe the machine by means of per unit inductance and resistance matrices (no "PARAMETER FITTING" card used), then the Class 2 S.M. data is completed with three cards of the following format:

L_f	L_{af}	L_{fkd}	L_d	L_{kd}	L_{kd}
E10.6	E10.6	E10.6	E10.6	E10.6	E10.6

L_g	L_{ag}	L_{gkq}	L_q	L_{kq}	L_{kq}
E10.6	E10.6	E10.6	E10.6	E10.6	E10.6

X_0	R_a	R_f	R_{kd}	R_g	R_{kq}	R_n	X_n
E10.6	E10.6	E10.6	E10.6	E10.6	E10.6	E10.6	E10.6

- L_f ----- The self-inductance of the field winding (circuit number 1 on the direct axis (d-axis) of the rotor), in per unit.
- L_{af} ----- The mutual-inductance coefficient between the armature and the field winding (circuit number 1 on the direct axis (d-axis) of the rotor), in per unit.
- L_{fkd} ----- The mutual-inductance coefficient between the field winding (circuit number 1 on the direct axis (d-axis) of the rotor) and the direct axis damper winding (circuit number 2 on the direct axis (d-axis) of the rotor), in per unit.

- L_d ----- The self-inductance coefficient for the direct axis (d-axis) of the armature, in per unit.
- L_{akd} ----- The mutual-inductance coefficient between the armature and the direct axis damper winding (circuit number 2 on the direct axis (d-axis) of the rotor), in per unit.
- L_{kd} ----- The self-inductance of the direct axis damper winding (circuit number 2 on the direct axis (d-axis) of the rotor), in per unit.

Note: Direct-axis parameters L_{af} , L_{jkd} , and L_{akd} are generally assumed to all be equal. But this is not a constraint of the EMTP code. Unequal values can be used, if available. Recent experience from the fifth European EMTP Users Group Meeting (held in Mannheim, Germany, October 24-25, 1983) indicates that this could improve the simulation results of currents.

Numbering of windings on the direct axis (d-axis) $\left\{ \begin{array}{l} \#1 \text{ ----- field winding of machine} \\ \#2 \text{ ----- d-axis damper winding} \end{array} \right.$

Numbering of windings on the quadrature axis (q-axis) $\left\{ \begin{array}{l} \#1 \text{ ----- q-axis damper winding} \\ \#2 \text{ ----- eddy current winding} \end{array} \right.$

- L_q ----- The self-inductance of the q-axis damper winding (circuit number 1 on the quadrature axis (q-axis) of the rotor), in per unit.
- L_{aq} ----- The mutual inductance coefficient between the armature and the q-axis damper winding (circuit number 1 on the quadrature axis (q-axis) of the rotor), in per unit.
- L_{gky} ----- The mutual inductance coefficient between the two circuits on the quadrature axis (q-axis) of the rotor, in per unit.
- L_q ----- The self-inductance coefficient for the quadrature axis (q-axis) of the armature, in per unit.
- L_{aky} ----- The mutual-inductance coefficient between the armature and the eddy-current winding (circuit number 2 on the quadrature axis (q-axis) of the rotor), in per unit.
- L_{ky} ----- The self-inductance of the eddy-current winding (circuit number 2 on the quadrature axis (q-axis) of the rotor), in per unit.

Note: Quadrature-axis parameters L_{aq} , L_{gky} , and L_{aky} are generally assumed to all be equal. But this is not a constraint of the EMTP code. Unequal values can be used, if available. See comment about the d-axis data.

- X_0 ----- Zero-sequence reactance, in per unit. If this is unknown, it is suggested that the value of $X_d / 0.95$ be used. See note about Wye-connection 2 pages back.
- R_a ----- Armature resistance, in per unit.
- R_f ----- Resistance of the field winding (winding number 1 on the direct axis), in per unit.
- R_{kd} ----- Resistance of the damper winding on the direct-axis (d-axis) of the rotor, in per unit. This is the resistance of winding number 2 on the d-axis of the rotor.
- R_q ----- Resistance of the q-axis damper winding (winding number 1 on the quadrature axis (q-axis) of the rotor), in per unit.
- R_{kq} ----- Resistance of the eddy-current winding (winding number 2 on the quadrature axis (q-axis) of the rotor), in per unit.
- R_n ----- The real part of the neutral grounding impedance, in per unit.
- X_n ----- The imaginary part of the neutral grounding impedance, in per unit.

} See note about Wye-connected armature two pages back.

Class 4 S.M. Data Cards

Next in order of data input come the mass cards which contain mechanical parameters for the shaft system. There is to be one such card for each mass, punched according to the format immediately below. In number, there are "NUMAS" such cards (see 1st card of Class 3 data, columns 1-2); ordering is actually immaterial (the mass cards can be shuffled), though it is generally clearer to stack such cards in naturally-increasing order of the mass number "ML"

ML	EXTRS	HICO	DSR	DSM	HSP	DSD
I2	E10.6	E10.6	E10.6	E10.6	E10.6	E10.6

ML ----- The mass number, to be punched in the field of columns 1-2 using I2 format. Recall that masses are to be numbered by the user beginning with number one on either end of the shaft system, and continuing sequentially (2,3,) to the other end. See Figs. 3 and 4 at the very beginning of Section 1.62.

EXTRS -- Punched in columns 11-20 (read using E10.6 format) is to be the fraction of the total external mechanical torque (power) which is associated with this mass:

Generator: For a generator, enter the fraction of the total external mechanical torque of this shaft system which is applied to this particular mass. If a pump, enter a negative value.

Motor: For a motor, enter the fraction of the total external mechanical torque of the shaft system which is developed by this particular mass. If a pump, enter a positive value.

HICO ----- The moment of inertia (WR) of mass number "ML" is read from the field of columns 21-30 using E10.6 format. This is to be in units of
[million pound-feet]

DSR ----- The speed-deviation self-damping coefficient for mass number "ML" is read from the field of columns 31-40 using E10.6 format. By definition,

$$T_i = \text{DSR} (W_i - W_s)$$

where T_i is this particular damping torque under consideration for mass number $i = ML$, W_i is the angular velocity of mass i , and W_s is the synchronous mechanical velocity for this shaft system. Data is to be punched in units of

[(pound-feet) / (radians/second)]

DSM ----- The mutual-damping coefficient is to be read from columns 41-50 using E10.6 format. This pertains to the present mass (assumed to be number $i = ML$) and the mass with the next higher number ($i+1$). The damping in question is function of the velocity difference between the two masses:

$$T = \text{DSM} (W_i - W_{i+1})$$

The mutual-damping coefficient is to be punched in units of

[(pound-feet) / (radians/second)]

HSP ----- The spring constant is to be read from columns 51-60 using E10.6 format. This pertains to the elastic connection between the present mass (assumed to be number $i = ML$) and the mass with the next higher number ($i+1$). Units for this data are

[(million pound-feet) / (radians)]

DSD ----- The absolute-speed self-damping coefficient for this mass is to be read from columns 61-70 using E10.6 format. By definition,

$$T_i = \text{DSD} * W_i$$

where T_i is the associated damping torque on mass number i , and W_i is the angular velocity (absolute) of this mass. Units for this data are

[(pound-feet) / (radians/second)]

It will be noted that fields "DSM" and "HSP" contain data which really does not belong exclusively to mass number $i = ML$ ' it also pertains equally to the mass which is numbered $i+1$. For mass card of the highest-numbered mass (number "NUMAS"), then, these two fields have no meaning, and are to be left blank.

Terminate the mass cards (Class 4 data cards) with a blank card.

CLASS 5 S.M. DATA CARDS (OUTPUT REQUESTS)

.1 General Remarks

The Class 5 (output request) cards follow the blank card terminating the Class 4 (mass) cards.

The requests for the output of S.M. variables are divided into five separate groups as follows:

1. Electrical variables.
2. Mechanical angles of shaft masses.
3. Mechanical speed deviations of shaft masses.
4. Mechanical torques on shaft sections.
5. Machine parameters and initial conditions.

To request an output of any S.M. variable, the user has to specify the output group to which the variable belongs and a unique number identifying that variable within that output group. The rules for assigning those numbers are explained in the following sections.

There is one common data card format for all different output groups. The user must specify the desired S.M. output(s) in the following format:

1	2	3	4	5	6	7	8	9	10	11	12	13	14	15	16	17	18	19	20	21	22	23	24	25	26	27	28	29	30	31	32	33	34	35	36	37	38	39	40	41	42	43	44	45				
2X	GROUP	FLAG	4X	N1	N2	N3	N4	N5																																								
	FF	FF		I6	I6	I6	I6	I6																																								

where:

Group - Flag identifying output group to which the variables specified on this card belong.

ALL - Flag identifying a request for the output of all possible variables in this output group:

- { 0 or blank, selective specification of variables in columns 9-80;
- { 1 ----- all possible variables in this class are to be outputted, columns 9-80 will not be scanned;

N1- -- N12 - Identification of variables to be outputted (in I6 format)

The output request cards can be stacked in any order, i.e., a request for output group i does not have to precede the request for output group i+1. Similarly, the variable numbers (columns 9-80) can be specified in any order. It is also possible to stack any number of cards specifying the requests for different variables within any output group.

A blank card terminates the Class 5 S.M. data cards (output requests).

.2 Specification of Variables in Output Group 1

Presently there are 15 possible variables in this group. The actual number will vary depending on the complexity of the model used.

The following Table summarizes the possible outputs in Group 1:

Variable	Output request number	Units	A6 format	EMTP Output identification name
ID	1	A	"ID	"
IQ	2	A	"IQ	"
IO	3	A	"IO	"
IF	4	A	"IF	"
ID2	5	A	"IKD	"
IQ1	6	A	"IG	"
IQ2	7	A	"IKQ	"
IA	8	A	"IA	"
IB	9	A	"IB	"
IC	10	A	"IC	"
VF	11	V	"EFD	"
MFORCE	12	A	"MFORCE	"
MANGLE	13	Rad	"MANGLE"	"
TEG	14	Nm*10 ⁶	"TQ GEN	"
TEXC	15	Nm*10 ⁶	"TQ EXC	"

Table I. Summary of Variables in Output Group 1.

where:

- ID - current in the d-axis armature winding;
- IQ - current in the q-axis armature winding;
- IO - current in the zero-axis armature winding;
- IF - field winding current (winding # on the direct axis);
- ID2 - current in the d-axis damper winding (winding #2 on the DIRECT AXIS);
- IQ1 - current in the q-axis damper winding (winding #1 on the quadrature axis);
- IQ2 - current in the q-axis eddy-current winding (winding #2 on the quadrature axis);
- IA - current in the phase 'a' armature winding;
- IB - current in the phase 'b' armature winding;
- IC - current in the phase 'c' armature winding;
- VF - voltage applied to the field winding; this will be a constant (dc) voltage, unless the user explicitly specifies a connection to TACS exciter dynamics as part of the Class 6 S.M. data cards.
- MFORCE - the total mmf in the air-gap of the machine;
- MANGLE - angle between the q-and the d-axis components of the total mmf (MFORCE);
- TEG - electrodynamic torque of the machine;
- TEXC - electromechanical torque of the exciter.

.3 Specification of Variables in Output Group 2

This output group contains the mechanical angles of the different masses in the lumped mass model of the turbine-generator set. The number of possible variables in this group depends on the number of masses used in the representation of the S.M. (see parameter NUMAS in Class 3 S.M. Data Cards).

Every mass of the turbine-generator set has been assigned a number during the specification of its parameters (Class 4 S.M. Data Cards). The same number is to be used when requesting the output of the mechanical angle of that mass. The output is in units of degrees.

.4 Specification of Variables in Output Group 3

This output group contains the deviations of the mechanical speeds of the different masses of the machine shaft from the synchronous speed. Similarly to Output Group 2, specify the appropriate mass number to obtain the desired output in units of rad/sec.

.5 Specification of Variables in Output Group 4

This output group contains the mechanical torques on the different shaft sections of the turbine-generator set. The shaft torque number i is the torque on the shaft section connecting masses number i and $i+1$ (there is, therefore, no output possible for a single-mass model). The units of the output are million Newton-meters ($Nm \cdot 10^6$).

.6 Specification of Variables in Output Group 5

This output group can be printed only immediately following the steady-state solution. At present, there are two possible requests in this group obtained by punching 1 and/or 2 in any of the variable number fields (columns 9-80) of Group 5 card:

punch 1 to request the printout of all machine parameters^a (reactances, resistances, shaft data etc,) following the steady-state solution;

punch 2 to request the complete printout of the initial conditions of a machine.

Note: Do not forget to terminate the output requests with a blank card.

For EMTP output and plotting purposes, the just-delineated output variables are actually identified by a pair of 6-character names. The second name (lower name of printed pair) identifies the variable type mneumonicly, as documented above. The first name (upper name of printed pair) identifies the generator in question, in order of data input. For example, "MACH 3" would be for the third machine. A specific example of such column headings of printed EMTP time-step-loop output follows (next page):

COLUMN HEADINGS FOR THE 32 EMTF OUTPUT VARIABLES FOLLOW. THESE ARE ORDERED ACCORDING TO THE FIVE POSSIBLE EMTF OUTPUT-VARIABLE CLASSES, AS FOLLOWS

- FIRST 12 OUTPUT VARIABLES ARE ELECTRIC-NETWORK NODE VOLTAGES (WITH RESPECT TO LOCAL GROUND);
 - NEXT 0 OUTPUT VARIABLES ARE BRANCH VOLTAGES (VOLTAGE OF UPPER NODE MINUS VOLTAGE OF LOWER NODE);
 - NEXT 4 OUTPUT VARIABLES ARE BRANCH CURRENTS (FLOWING FROM THE UPPER EMTF NODE TO THE LOWER);
 - NEXT 16 OUTPUT VARIABLES PERTAIN TO DYNAMIC SYNCHRONOUS MACHINES, WITH NAMES GENERATED INTERNALLY;
 - FINAL 0 OUTPUT VARIABLES BELONG TO 'TACS' (NOTE INTERNALLY-ADDED UPPER NAME OF PAIR).
- BRANCH POWER CONSUMPTION (POWER FLOW, IF A SWITCH) IS TREATED LIKE A BRANCH VOLTAGE FOR THIS GROUPING!
 BRANCH ENERGY CONSUMPTION (ENERGY FLOW, IF A SWITCH) IS TREATED LIKE A BRANCH CURRENT FOR THIS GROUPING.

STEP	TIME	C2	B2	A2	A3	C3	B3	A1	B1	C1
		A4	B4	C4	A3 TERRA	A1 A2	B1 B2	C1 C2	MACH 1 ID	MACH IQ
		MACH 1 TO	MACH 1 IF	MACH 1 IKD	MACH 1 IG	MACH 1 IKQ	MACH 1 IA	MACH 1 IB	MACH 1 IC	MACH EFD
		MACH 1 MFORCE	MACH 1 MANG	MACH 1 TO GEN	MACH 1 ANG 1	MACH 1 VEL 1				
0	0.000000	0.791459E-01-0.929561E+01	0.921647E+01	0.102547E+03-0.378518E+02-0.646953E+02	0.986412E+01-0.986412E+01	0.436783E-				
		0.105301E+03-0.858422E+02-0.194588E+02	0.000000E+00	0.647649E+01-0.568503E+01-0.791459E+00-0.682118E+01	0.532563E+					
		0.233159E-14	0.101434E+01	0.222045E-15-0.693889E-17	0.000000E+00	0.647649E+01-0.568503E+01-0.791459E+00-0.184961E+				
		0.603575E+00	0.881956E+00	0.382277E-06	0.118450E+03	0.000000E+00				
1	0.000200	-0.592860E+00-0.894556E+01	0.953842E+01	0.103317E+03-0.438434E+02-0.594739E+02	0.102025E+02-0.948660E+01-0.715928E+					
		0.107500E+03-0.811500E+02-0.263498E+02	0.000000E+00	0.664107E+01-0.541040E+01-0.123068E+01-0.682126E+01	0.532553E+					
		-0.471680E-15	0.101435E+01	0.644931E-05	0.936663E-05	0.000000E+00	0.664107E+01-0.541040E+01-0.123068E+01-0.184961E+			
		0.603575E+00	0.881956E+00	0.382276E-06	0.118450E+03	0.710543E-14				

Old Style output request card

This single output-variable card represents the old-style Class 5 S.M. Data Card. It is less flexible than the output-variable request described earlier and it will, most probably, be removed in the near future.

To get access this old-style request:

Do not terminate the mass (Class 4 S.M.) data cards with a blank. Following the last mass card insert a card which is to be punched according to the format described immediately below.

Only those synchronous machine variables which are explicitly requested for output using this card will be a part of the EMTF output vector, which is used for both printing and plotting. The request scheme, unless otherwise noted below, is:

- "0" ---- leave blank, or punch a zero, if no such output is desired;
- "1" } ---- punch unity or two for output in physical
- "2" } (MKS) units. No per unit output is possible.

1	2	3	4	5	6	7	8	9	10	11	12	13 ...	23	...	33	...
JPAR	JMIC	JIDQB	JFI	JD2	JQ1	JQ2	JFV	JETM	JETE	JIABC	JSAT	Angles θ_i $1 \leq i \leq 10$	Speeds ω_i $1 \leq i \leq 10$		Torques T_i $1 \leq i \leq 9$	
I1	I1	I1	I1	I1	I1	I1	I1	I1	I1	I1	I1	all I1	all I1		all I1	

JPAR ----- Controls printout of the machine inductances and resistances, plus the mechanical data of the shaft system, during the steady-state initial-condition printout.

JMIC ----- Controls printout of the initial conditions for this synchronous machine, which are based on the EMTF steady-state phasor network solution. Punch 1 or 2 to get such output; leave blank (or punch a "0") to suppress it.

- JIDQO ----- Controls printout of the armature currents in d-q-o coordinates (rotating reference frame), within the time-step loop. The EMTP names which are used for output identification are (all A6 format) "ID ", "IQ ", and "IQ " . See also Col. 11.
- 3
- JFI ----- Controls printout of the current in the field winding of the machine (circuit number 1 on the direct axis). The EMTP name which is used for output identification is "IF " .
- 4
- JD2 ----- Controls printout of the current in the damper winding of the direct axis (d-axis) of the machine. The winding in question is winding number 2 on the d-axis. The EMTP name which is used for output identification is "IKD " .
- 5
- JQ1 ----- Controls printout of the current in the q-axis damper winding (circuit number 1 on the quadrature axis (q-axis) of the rotor). The EMTP name which is used for output identification is "IG " .
- 6
- JQ2 ----- Controls printout of the current in the eddy-current winding (circuit number 2 on the quadrature axis (q-axis) of the rotor). The EMTP name which is used for output identification is "IKQ " .
- 7
- JFV ----- Controls printout of the voltage which is applied to the field winding by the exciter. The EMTP name which is used for output identification is "VF " .
- 8
- JETM ----- Controls printout of the elect dynamic torque on the machine rotor. The EMTP name which is used for output identification is "TQ GEN" .
- 9
- JETE ----- Controls printout of the electromechanical torque at the exciter. The EMTP name which is used for output identification is "TQ EXC" .
- 10

- JIABC ----- Controls printout of the machine armature currents in phase coordinates (actual coil variables), within the time-step loop. The EMTP names which are used for output identification are (all A6 format) "IA " , "IB " , and "IC " .
- 11

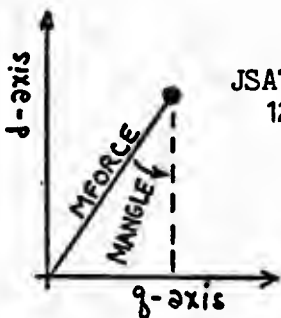

- JSAT ----- Controls the printout of the machine flux; or more precisely, of the magnetomotive force (MMF) which drives it. If this output is selected, two EMTP variables are produced: one for the magnitude of the flux, and the other for the angle (see sketch at left). The EMTP names which are used for output identification of these variables are "MFORCE" and "MANGLE" , respectively. Units of the output are ampere-turns and radians , respectively.
- 12

- θ_i ----- The I1 field of column 12 + i controls printout of the mechanical angle Q of mass number i , for i less than or equal to 10. Units of output are degrees. The angles in question are all measured with respect to a synchronously-rotating reference frame;

The EMT name which is used for output identification of the angle θ of mass I is "ANG I" .

For example, the name associated with the angle of mass number nine is "ANG 9", while that for mass number ten is "ANG 10" .

W_i ----- The I1 field of column 22 + i controls printout of the angular velocity W of mass number i, for i being a positive integer that does not exceed 10. Units for this output are radians/second. The EMT name which is used for output identification of the mechanical angular velocity W of mass I is "VEL I" .

T
i,i+1 ----- The I1 field of column 32 + i controls printout of the torque on the shaft which connects mass number i with mass number i+1, for i a positive integer that does not exceed 9. The EMT name which is used for output identification of the shaft torque in question (between mass i and mass i+1) is "TOR I" . Units of the output are million Newton-meters.

NOTE: Do not terminate this card with a blank card.
Class 6 S.M. Data Cards

Next in order of data input come cards which describe any interface connections between the machine under consideration, and TACS. The general format for the one or more such cards of Class 6 is as follows.

1	2	3	4	5	6	7	8	9	10	11	12	13	14	15	16	17
K			B	U	S										K	I
I	R		A	6					6	X					I	3

Rule 1 : If the field voltage of the machine is to be controlled by exciter dynamics which have been modeled using TACS, then the following is required:

KK ---- Punch "71" in columns 1-2, as a special request for the exciter connection.

BUS ---- The 6-character name of a TACS variable is to be punched in columns 3-8. The numerical value of this TACS variable will then be used by the EMT logic for the field voltage v of this machine.

If no such card is used, the EMT logic will simply hold the field voltage for this machine constant, at whatever value was dictated by the initial conditions.

Rule 2 : If the mechanical power applied to any mass on the shaft system is to be controlled by dynamics which are modeled using TACS, then the following card is required:

KK ---- Punch "72" in columns 1-2, as a special request for the TACS control of mechanical power.

BUS ---- The 6-character name of a TACS variable is to be punched in columns 3-8. the numerical value of this TACS variable will then be used by the EMTP logic as a multiplicative factor for scaling the otherwise-constant (steady-state) power values.

KI ---- Punch in columns 15-17 the mass number whose externally applied mechanical power is to be controlled by TACS variable BUS.

Should the user want to code the logic of this TACS connection, but temporarily bypass any associated dynamics, he can use the "UNITY" . Recall that this is the name of the built-in TACS source which has output identically equal to 1.0.

If no such card is used for mass #N, , the EMTP logic will simply hold the external mechanical power applied to that mass constant (at whatever value was dictated by the initial condition calculation). Consequently, the user can selectively control the mechanical power on different shaft sections.

Rule 3 : If the internal electrical machine variables are to be passed into TACS from the machine, then the following is required. There can be either zero, or one, or more such cards:

KK ---- Punch "73" in columns 1-2 as a special request for the internal electrical machine variables.

BUS ---- The 6-character name of the TACS source whose value is to be equal to the desired electrical machine variable at each time-step.

KI ---- Punch variable number in columns 15-17.

The following variables can be passed to TACS:

Variable	TACS request number	Units
ID	1	A
IQ	2	A
IO	3	A
IF	4	A
ID2	5	A
IQ1	6	A
IQ2	7	V
VD	8	V
VQ	9	V
VO	10	V
VF	11	V
MFORCE	12	A
MANGLE	13	Rad
TEG	14	Nm*10 ⁶
TEXC	15	Nm*10 ⁶
PSID	16	Weber-turn
PSIQ	17	Weber-turn

Table II. Summary of Variables Accessible by TACS

where:

- ID - current in the d-axis armature winding
 - IQ - current in the q-axis armature winding
 - IO - current in the zero-axis armature winding
 - IF - field winding current (winding # on the direct axis)
 - ID2 - current in the d-axis damper winding (winding #2 on the direct axis)
 - IQ1 - current in the q-axis damper winding (winding #1 on the quadrature axis)
 - IQ2 - current in the q-axis eddy-current winding (winding #2 on the quadrature axis)
 - VD - voltage applied to the d-axis
 - VQ - voltage applied to q-axis
 - VO - voltage applied to zero-axis
 - VF - voltage applied to the field winding; this will be a constant (dc) voltage, unless the user explicitly specifies a connection to TACS exciter dynamics as part of the Class 6 S.M. data cards.
-
- MFORCE - the total mmf in the air-gap of the machine
 - MANGLE - tangle between the q-and the d-axis components of the total mmf (MFORCE)
 - TEG - electrodynamic torque of the machine
 - TEXC - electromechanical torque of the exciter
 - PSID - d-axis flux linkage
 - PSIQ - q-axis flux linkage

A separate data card is needed for each variable.

Rule 4 : If one or more mechanical angles Q_i , angular velocities W_i , or shaft torques T_i of the shaft system of the machine are to be passed into TACS, then one data card must be punched for each such variable. Angles are in units of absolute radians (eg, increasing by $2\pi f$ every second for 60 Hz steady-state operation), angular velocities are in radians/second, and shaft torques are in million newton-meters. The data card format is:

- KK ---- Punch "74" in columns 1-2 as a special request for the access to mechanical variables of the S.M.
- BUS ---- The EMTP reads from columns 3-8 a 6-character alphanumeric name. This field is to be punched with the name of the TACS source whose value is to be controlled by the mechanical machine variable in question.
- KI ---- The EMTP reads from columns 15-17 a code number which identified the mechanical variable in question:

for θ_i , punch i
 for W_i , punch NUMAS + i
 for T_i , punch 2 * NUMAS + i

Type-50 Dynamic Synchronous Machine (S.M.) Exists No Longer

Earlier program versions ("M32." and before) contained both the present Type-59 S.M. modeling just described and also the original Type-50 S.M. model. Type-50 modeling was developed by Southern California Edison (SCE) in the aftermath of the disastrous Mohave SSR accident, and it worked well for many years (between 1975 and 1982, most EMTF users who modeled generator dynamics used this code). But it was slow compared with the Type-59 alternative, and inflexible compared with the U.M. alternative (Section 1.63). For some three years, there had been a warning of impending Type-50 removal unless users could show us good reason not to do so. During the late fall of 1982, as Vladimir prepared to leave Toronto for Palo Alto (to work for Systems Control, Inc.), he volunteered to do the work if we in Portland approved. Viewing this as a now-or-never opportunity, we approved, and the "M33." update at the end of the year was missing the Type-50 alternative. Users to have data cases with such data had just to convert of Type-59 or U.M. models, temporarily (for "M33." and "M34." versions). But beginning with "M35." versions, the old Type-50 data was once again accepted ---- not by the Type-50 code (which has indeed vanished forever), but by the Type-59 code. Recall that input data were very close anyway, so we had our Chinese visitor Ma Ren-ming simply modify Vladimir's input module "SMDAT" of overlay 5 for this. Very little was involved, other than honoring the old output-variable request card (Class 5 S.M. data cards). The situation became more complicated as of January, 1984 ("M38." version). A complete overhaul of the TACS interface and changes to saturation modeling made it difficult to maintain a full data compatibility. If the type-50 data case does not have any SM-TACS connections, then the SCE ^{data} can still be run provided that the previously optional q-axis saturation card is added. The TACS-SM connection cards, if present, have to be completely redone.

How to Modify the Limits on Masses, Generators, Output Variables

As of January of 1984 ("M38." vintage), the Type-59 S M. code is variably dimensioned. List 17 (see Section 0.6) defines the maximum number of machines while List 16 defines the maximum number of masses to be modeled on all machines. The size of the integer output vector (ISMOUT) is controlled by List 11. Only the auxiliary (internal) vectors Z and X1 remain fixed dimensioned, and they can be found in the UTF deck (FORTRAN "INCLUDE" file) named "SYNMAC", which is used in a number of different overlays of the program. For those computers with FORTRAN which does not have "INCLUDE" (e.g., IBM H-Extended) it is to be emphasized that all appearances of the labeled COMMON block /SMACH/ are identical in every respect, since they are made by copying the same master file (UTF deck). Hence if one is searching for such records using the system editor, he can count on fixed column positioning of all key characters. At least this will be the situation with EMTF FORTRAN as generated by machine translation (execution of Editor/Translator programs); if local Program Maintenance should upset this detail for some reason (e.g., by manual editing of program FORTRAN), then all bets are off! A listing follows (next page):

```

M16. 111      DECLARATION SYMAC
M33.  5C      REAL VARIABLES PRECEDE INTEGER ONES *****
M33.  32C     AUXILLIARY ARRAYS ( SIZE BASED ON NO. OF WINDINGS =.7 ) *****
M37.  97      COMMON /SMACH/  Z(100),X1(36)
M38.  37C     OUTPUT VECTOR *****
M33.  34C     COMPUTATIONAL CONSTANTS *****
M33.  35      COMMON /SMACH/  SQRT3,ASQRT3,SQRT32,THTW,ATHTW,RADEG,OMDT
M38.  39      COMMON /SMACH/  FACTOM,DAMRAT,DELTA6,OM2,BIN,BDAM
M33.  37C     INTEGER VARIABLES *****
M38.  40      COMMON /SMACH/  MFIRST, NST, ITOLD, IBROLD, NSMOUT

```

It should also be pointed out that all TACS-SM interface vector are contained in the UTPF deck (FORTRAN "INCLUDE" file) named "SYNCON" which appears in a number of different overlays of the program. A listing follows:

```

M31.  14      DECLARATION SYNCOM
M38.  41C     THIS DECK CONTAINS S.M. STORAGE USED BY TACS MODULES.
M38.  42      COMMON /SMTACS/  ETAC(20)
M38.  43      COMMON /SMTACS/  ISMTAC(20), NTOTAC, LBSTAC

```

Instructions for the Deletion of Type-59 S.M. Modeling

Since the U.M. can represent any machinery configuration which the S.M. can (plus many others which the S.M. can not), those who must minimize the size of their programs due to computer limitations (most often non-virtual architecture with limited central memory) might consider deletion of the Type-59 S.M. modeling. It is really very simple, following the structural reform documented in Ref. 8, Vol. XI, 18 October 1981, Section II-C, pages SSIA-10 through 12.

Deletion of Type-59 S.M. modeling begins with the omission of all S.M. SUBROUTINES. The following is a complete list:

```

Overlay 5 : "SMDAT", "SMPFIT", "SMOUT"
Overlay 11: "SMINT", "UNCOR"
Overlay 12: "PREMEC", "ELEC"
Overlay 14: "PAST"
Overlay 16: "UPDATE", "INCREM"

```

The previously-listed COMMON /SMACH/ storage will all disappear in the process, except for one usage in SUBROUTINE TABLES of UTPF overlay number 0 ("MAIN10" overlay), which must be manually deleted.

The user should also set the list sizes no. 11, 16, and 17 to minimum value of 1 while variably dimensioning the EMTP (See Section 0.6).

1.63 Complete Rules for U.M. Data Assembly and UsageINTRODUCTION

The U.M. module of the EMTF currently can be used to represent 12 major types of electric machines, as will be described in the next section. Despite the universality of the program set-up, a serious attempt is made not to burden the user with this universality if only the use of one or a few of the available types is desired. Therefore, a user's guide is given for each U.M. type. Then taking up these instructions for the desired U.M. type, reference will be found to the rules for setting up the three classes of U.M. data cards as described in the section regarding the format of the U.M. data cards. In the EMTF M32 and higher versions, it is possible to run the U.M. with the S.M. Type 50 to 59 Data Input. In this case, no understanding about the rules pertaining to the U.M. is required at all. Instead, only the rules as described in the section "U.M. with S.M. Type-59 Data Input" apply. The following points can be remarked:

1.63 A Number of machines and coils, compensation:

The number of U.M. machines which can be used is arbitrary. For each machine the following rules apply. The maximum number of coils on the power side is restricted to three. This is obviously justified by our today's usage of electric machines. These three coils are 3-phase compensated, i.e., they can be externally connected to each other in one electrical network. As far as compensation of the excitation coils is concerned, the general rule here is that only the first three excitation coils are 3-phase compensated, i.e., only the first three excitation coils are permitted to be externally connected to each other in one single electric network. If in addition more excitation coils are used, then each of these coils must be totally disconnected from other coils used. It is to be remarked that the above outlined restrictions can be overcome by the approach of using stub lines or inserting a TACS element between U.M. machines or between coils which are not supposed to be connected to each other.

1.63 B Note on coil parameters:

The purpose of this note is to supply conversion formulas for users who have data of coil-parameters specified in terms of self and mutual inductances, which due to the current U.M. data input have to be expressed in terms of leakage and main inductances. It is possible that future development will include an automatic preprocessor for this purpose.

In the next discussion the following notation will be adopted:

L_{li} = leakage inductance of coil i [H]

L_{mi} = main inductance of coil i [H]

R_i = resistance of coil i [Ohm]

2-Coil System:

The idea of how to obtain the leakage and main inductances from the self and mutual inductances will be illustrated for a transformer. Although a transformer is not an electrical machine, the basic mechanism to derive the desired conversion formulas is essentially not different. This is because an inductance is a parameter describing the relation between a coil current and the magnetic flux enclosed by the coil contour. By considering a 2 coil transformer, the central idea can be most easily understood.

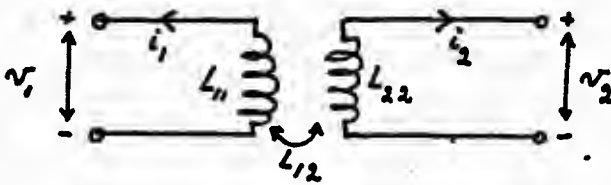

For the transformer as shown schematically in the figure above, the voltage equations can be written as:

$$v_1 = -R_1 i_1 - \frac{d\lambda_1}{dt} \quad (1)$$

$$v_2 = -R_2 i_2 - \frac{d\lambda_2}{dt}$$

The current-flux relation in terms of self-inductances, L_{11} and L_{22} , and of mutual inductance L_{12} , can be expressed as:

$$\begin{bmatrix} \lambda_1 \\ \lambda_2 \end{bmatrix} = \begin{bmatrix} L_{11} & L_{12} \\ L_{12} & L_{22} \end{bmatrix} \begin{bmatrix} i_1 \\ i_2 \end{bmatrix} \quad 36 \text{ g-1} \quad (2)$$

with: $L_{12} = L_{21} = \frac{N_1 N_2}{R_m}$

$$L_{11} = L_{\ell 1} + \frac{N_1^2}{R_m} \quad (3)$$

$$L_{22} = L_{\ell 2} + \frac{N_2^2}{R_m}$$

where N = number of turns and R_m = magnetic reluctance.

To express the equations in terms of leakage and mutual inductances, one of the "sides" of the transformer has to be reduced (referred) to the other.

Let us reduce the secondary side (index 2) to the primary side (index 1). Then introduce the following reduction factor, which for transformers specifically is called turn ratio:

$$a_2 = \frac{N_1}{N_2} \quad (4)$$

Now rewrite the voltage equations Eqn (1) as:

$$v_1 = -R_1 i_1 - \frac{d\lambda_1}{dt} \quad (5)$$

$$a_2 v_2 = - (a_2^2 R_2) (i_2/a_2) - \frac{d}{dt} (a_2 \lambda_2)$$

and also rewrite the current-flux relations Eqn (2) as:

$$\begin{bmatrix} \lambda_1 \\ a_2 \lambda_2 \end{bmatrix} = \begin{bmatrix} L_{11} & a_2 L_{12} \\ a_2 L_{12} & a_2^2 L_{22} \end{bmatrix} \begin{bmatrix} i_1 \\ i_2/a_2 \end{bmatrix} \quad (6)$$

Now by introducing the so-called reduced secondary variables:

$$v_2' = a_2 v_2$$

$$i_2' = i_2 / a_2 \quad (7)$$

$$R_2' = a_2^2 R_2, \quad L_{22}' = a_2^2 L_{22}$$

and realizing from Eqn (3) that

$$L_{m1} = a_2 L_{12} \quad (8)$$

The transformer can be described by the equations:

$$\begin{aligned} v_1 &= -R_1 i_1 - \frac{d\lambda_1}{dt} \\ v_2' &= -R_2' i_2' - \frac{d\lambda_2'}{dt} \end{aligned} \quad (9)$$

$$\begin{bmatrix} \lambda_1 \\ \lambda_2' \end{bmatrix} = \begin{bmatrix} L_{11} & L_{m1} \\ L_{m1} & L_{22}' \end{bmatrix} \begin{bmatrix} i_1 \\ i_2' \end{bmatrix} \quad (10)$$

Now at this point L_{11} and L_{22}' can be partitioned as:

$$\begin{aligned} L_{11} &= L_{l1} + L_{m1} \\ L_{22}' &= a_2^2 L_{22} = a_2^2 L_{l2} + L_{m1} = L_{l2}' + L_{m1} \end{aligned}$$

so that from Eqn (9) we have the current-flux relation:

$$\begin{aligned} \lambda_1 &= L_{l1} i_1 + L_{m1} (i_1 + i_2') \\ \lambda_2' &= L_{l2}' i_2' + L_{m1} (i_1 + i_2') \end{aligned}$$

The leakage inductance is then identified as L_{l1} and L_{l2}' , and both coils have now the same main inductance L_{m1} .

On the basis of the formulation of Eqn (8) and Eqn (10) the transformer can be interpreted as having the following connected network:

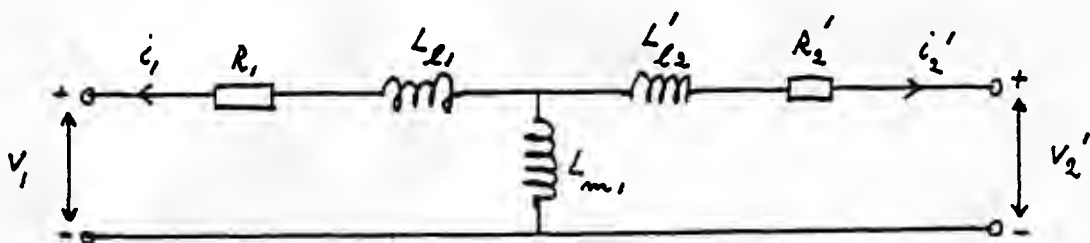

Several conclusions can now be made:

- (a) Physically this formulation corresponds with the concept of 2 coils linked by a main flux in addition to their individual leakage fluxes. The usefulness of this formulation to numerical implementation is the fact that practically only the main inductance L_m is susceptible to changes if the magnetic material becomes saturated.
- (b) If the reduction factor a_2 is given, then the conversion formulas needed to obtain the main and leakage inductances from given self and mutual inductances, are:

$$\begin{aligned} L_{m1} &= a_2 L_{12} \\ L_{\ell 1} &= L_{11} - L_{m1} \\ L'_{\ell 2} &= a_2^2 L_{22} - L_{m1} \end{aligned} \quad (11)$$

- (c) If the reduction factor is not given, then the following approximated conversion formulas is suggested:

$$\begin{aligned} L_{m1} &= 0.9 L_{11} \quad , \quad L_{\ell 1} = 0.1 L_{11} \\ a_2 &= L_{m1} / L_{12} \\ L'_{\ell 2} &= a_2^2 L_{22} - L_{m1} \end{aligned} \quad (12)$$

Sometimes the rated currents I_{1B} and I_{2B} are given. In this case the reduction factor can be approximated by:

$$a_2 = \frac{I_{2B}}{I_{1B}} \quad \left(\text{or } \frac{V_{1B}}{V_{2B}} \right) \quad (13)$$

Then the Conversion formulas of Eqn (11) can be used to obtain the desired main and leakage inductances.

(d) All parameters and variables of the secondary side, including the network to which it is connected, has to be reduced (see Eqn. 7), i.e.

- * their voltages are to be multiplied by a_2 .
- * their currents are to be divided by a_2 .
- * their resistances and inductances are to be multiplied by a_2^2 .

4-Coil System:

The concept of the 2-coil system linked by a main flux in addition to their individual leakage flux, can be easily extended to the general n-coil system. We will show this by considering a 4-coil system, and again we are interested to find the conversion formulas to obtain main and leakage inductances from self and mutual inductances.

In terms of self and mutual inductance, the 4-coil system is described by:

- * the voltage equations:

$$\begin{aligned} v_1 &= -R_1 i_1 - \frac{d\lambda_1}{dt} \\ v_2 &= -R_2 i_2 - \frac{d\lambda_2}{dt} \\ v_3 &= -R_3 i_3 - \frac{d\lambda_3}{dt} \\ v_4 &= -R_4 i_4 - \frac{d\lambda_4}{dt} \end{aligned} \quad (14)$$

- * the current-flux relation:

$$\begin{bmatrix} \lambda_1 \\ \lambda_2 \\ \lambda_3 \\ \lambda_4 \end{bmatrix} = \begin{bmatrix} L_{11} & L_{21} & L_{31} & L_{41} \\ L_{12} & L_{22} & L_{32} & L_{42} \\ L_{13} & L_{23} & L_{33} & L_{43} \\ L_{14} & L_{24} & L_{34} & L_{44} \end{bmatrix} \begin{bmatrix} i_1 \\ i_2 \\ i_3 \\ i_4 \end{bmatrix}; \quad L_{ij} = L_{ji} \quad (15)$$

- * the inductances in terms of the number of turns N and magnetic reluctance R_m :

$$L_{ij} = \frac{N_i N_j}{R_m} \quad \text{for } i \neq j$$

$$L_{ii} = L_{li} + \frac{N_i^2}{R_m} \quad \text{for } i = 1, 2, 3, 4 \quad (16)$$

Now in analogy with the 2-coil system, we reduce coil 2, 3 and 4 to the "primary" coil 1. This requires the introduction of 3 reduction factors (compare with Eqn. 4):

$$a_2 = \frac{N_1}{N_2}, \quad a_3 = \frac{N_1}{N_3}, \quad a_4 = \frac{N_1}{N_4} \quad (17)$$

These reduction factors are implemented in the system equations in the same way as for the 2-coil system shown in Eqn. (5) and (6):

* the voltage equations:

$$\begin{aligned} v_1 &= -R_1 i_1 - \frac{d}{dt}(\lambda_1) \\ a_2 v_2 &= -(a_2^2 R_2)(i_2/a_2) - \frac{d}{dt}(a_2 \lambda_2) \\ a_3 v_3 &= -(a_3^2 R_3)(i_3/a_3) - \frac{d}{dt}(a_3 \lambda_3) \\ a_4 v_4 &= -(a_4^2 R_4)(i_4/a_4) - \frac{d}{dt}(a_4 \lambda_4) \end{aligned} \quad (18)$$

* the current-flux relation:

$$\begin{bmatrix} \lambda_1 \\ a_2 \lambda_2 \\ a_3 \lambda_3 \\ a_4 \lambda_4 \end{bmatrix} = \begin{bmatrix} L_{11} & a_2 L_{12} & a_3 L_{13} & a_4 L_{14} \\ a_2 L_{12} & a_2^2 L_{22} & a_2 a_3 L_{23} & a_2 a_4 L_{24} \\ a_3 L_{13} & a_2 a_3 L_{23} & a_3^2 L_{33} & a_3 a_4 L_{34} \\ a_4 L_{14} & a_2 a_4 L_{24} & a_3 a_4 L_{34} & a_4^2 L_{44} \end{bmatrix} \begin{bmatrix} i_1 \\ i_2/a_2 \\ i_3/a_3 \\ i_4/a_4 \end{bmatrix} \quad (19)$$

Now at this point it is important to observe that due to Eqn. (16), all off-diagonal terms of the inductance matrix above are equal to the main inductance L_{m1} . In fact this is the reason of introducing the reduction factors. Thus:

$$L_{m1} = a_2 L_{12} = a_3 L_{13} = a_4 L_{14} = a_2 a_3 L_{23} = a_2 a_4 L_{24} = a_3 a_4 L_{34} \quad (20)$$

Moreover, again due to Eqn. (16) we have for the diagonal terms:

$$\begin{aligned} L_{11} &= L_{l1} + L_{m1} \\ a_2^2 L_{22} &= a_2^2 L_{l2} + L_{m1} \\ a_3^2 L_{33} &= a_3^2 L_{l3} + L_{m1} \\ a_4^2 L_{44} &= a_4^2 L_{l4} + L_{m1} \end{aligned} \quad (21)$$

Finally considering the results of Eqn. (18) to (21) we introduce the reduced variables for coil 2, 3 and 4 according to the same rule as for the 2-coil system. For $i = 2, 3, 4$, define:

$$\begin{aligned} v_i' &= a_i v_i \\ i_i' &= i_i / a_i \\ R_i' &= a_i^2 R_i \quad , \quad L_{ii}' = a_i^2 L_{ii} \quad , \quad L_{li}' = a_i^2 L_{li} \end{aligned} \quad (22)$$

Then our 4-coil system equations become:

* the voltage equations:

$$\begin{aligned} v_1 &= -R_1 i_1 - \frac{d}{dt} (\lambda_1) \\ v_2' &= -R_2' i_2' - \frac{d}{dt} (\lambda_2') \\ v_3' &= -R_3' i_3' - \frac{d}{dt} (\lambda_3') \\ v_4' &= -R_4' i_4' - \frac{d}{dt} (\lambda_4') \end{aligned} \quad (23)$$

* the current flux relations:

$$\begin{aligned} \lambda_1 &= L_{l1} i_1 + L_{m1} (i_1 + i_2' + i_3' + i_4') \\ \lambda_2' &= L_{l2}' i_2' + L_{m1} (i_1 + i_2' + i_3' + i_4') \\ \lambda_3' &= L_{l3}' i_3' + L_{m1} (i_1 + i_2' + i_3' + i_4') \\ \lambda_4' &= L_{l4}' i_4' + L_{m1} (i_1 + i_2' + i_3' + i_4') \end{aligned} \quad (24)$$

Conclusions we can make are:

- Basically the results for a 4-coil system are just extensions of the 2-coil system, in that we are able to obtain a main flux concept as represented by one main inductance L_{m1} in addition to the individual leakage fluxes of each coil as represented by L_{l1} , L_{l2}' , L_{l3}' , and L_{l4}' .
- The system formulation in terms of main and leakage inductances requires the reduction of all coils to one coil, which in above examples is coil 1. This means that all coils (plus networks connected to these coils) other

than coil 1 should have:

- * their voltages multiplied by the corresponding reduction factor.
- * their currents divided by the corresponding reduction factor.
- * their resistances and inductances multiplied by the corresponding square of the reduction factor.

(c) If all reduction factors are given, then the conversion formulas to obtain the main and leakage inductances from given self and mutual inductances are:

$$\begin{aligned} L_{m1} &= a_2 L_{12} \\ L_{l1} &= L_{11} - L_{m1} \\ L'_{li} &= a_i^2 L_{ii} - L_{m1} \end{aligned} \quad (25)$$

(d) If the reduction factors are not given, then the following approximated conversion is suggested:

$$\begin{aligned} L_{m1} &= 0.9 L_{11} \quad , \quad L_{l1} = 0.1 L_{11} \\ a_i &= L_{m1} / L_{1i} \\ L'_{li} &= a_i^2 L_{ii} - L_{m1} \end{aligned} \quad \left. \vphantom{\begin{aligned} L_{m1} &= 0.9 L_{11} \\ a_i &= L_{m1} / L_{1i} \\ L'_{li} &= a_i^2 L_{ii} - L_{m1} \end{aligned}} \right\} \text{for } i = 2, 3, 4 \quad (26)$$

(e) Sometimes the rated currents I_{iB} are given. In this case the reduction factors can be approximated by :

$$a_i \approx \frac{I_{iB}}{I_{1B}} \quad \left(\text{or } \frac{V_{1B}}{V_{iB}} \right) \quad \text{for } i = 2, 3, 4 \quad (27)$$

Having determined these reduction factors, the formulas in Eqn. (25) can be used to obtain the main and leakage inductances.

If only I_{1B} and I_{2B} are given, then find all a_i from:

$$a_2 \approx \frac{I_{2B}}{I_{1B}} \quad \left(\text{or } \frac{V_{1B}}{V_{2B}} \right)$$

$$\text{Then find } L_{m1} = a_2 L_{12}$$

$$\text{Then find } a_3 \text{ and } a_4 \text{ from: } a_i = L_{m1} / L_{1i}$$

Extension to Electric Machines

The concept of coils on the same magnetic shaft as linked by a main flux in addition to the individual leakage fluxes can be carried over to the coil-arrangement of electric machines. In the Park domain these magnetic shafts are the direct and quadrature axis. Then for each of these axis, the conversion formulas as given in Eqn. (25), (26), and (27) can be applied. A rigorous account of the reduction process to the power side d- and q-coil can be found for instance in: White and Woodson, "Electromechanical Energy Conversion", John Wiley.

Basically the main and leakage inductances are introduced in the same way as explained here in this note, except that proper account have to be taken of the winding distribution factors rather than by considering the number of turns only.

Let us now consider the case that all excitation coils are coils which have magnetic shafts either in the direct (d)-axis or in the quadrature (q)-axis or in both axis. See later special notes on Direct Current machines and UM type 4. It is convenient to formulate the main and leakage inductances on the basis of reduction of all excitation coils to the power coils which are positioned on the same magnetic shaft.

If the power side is a three-phase system, then their equivalent coil-parameters in the Park domain have to be determined first. This is a well-known procedure, and let us call these equivalent power coils the o-coil, d-coil, and q-coil. The o-coil is decoupled from all other coils, the magnetic shaft of the d-coil is in the direct (d) axis and the magnetic shaft of the q-coil is in the quadrature (q) axis.

Now let us consider the following example. Suppose that we have 4 excitation coils, 2 coils D and F on the d-axis and 2 coils Q and G on the q-axis. The system is schematically shown in the figure below:

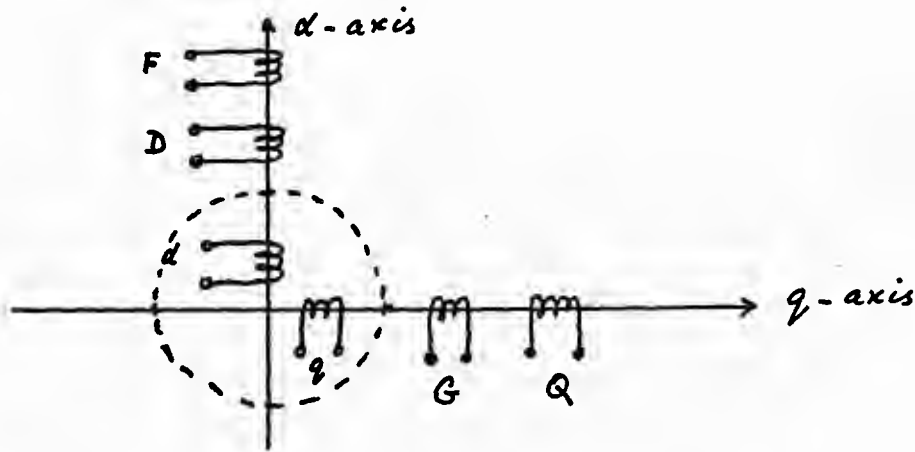

d- and q- coils : power coils ; F, D, G, Q- coils : excitation coils

Now suppose that the user has available all self and mutual inductances.

Then in order to find the main and leakage inductances as required by the UM, the same approach can be taken as outlined for the 4-coil system.

(a) If the reduction factors are given:

$$\begin{aligned}
 L_{md} &= a_F L_{dF} & L_{mq} &= a_G L_{qG} \\
 L_{ld} &= L_{dd} - L_{md} & L_{lq} &= L_{qq} - L_{mq} \\
 L'_{lF} &= a_F^2 L_{FF} - L_{md} & L'_{lG} &= a_G^2 L_{GG} - L_{mq} \\
 L'_{lD} &= a_D^2 L_{DD} - L_{md} & L'_{lQ} &= a_Q^2 L_{QQ} - L_{mq}
 \end{aligned}$$

Note: The prime on some of the variables indicates that they are reduced variables.

(b) If the reduction factors are not given, then the following approximated conversion is suggested.

$$\begin{aligned}
 L_{md} &= 0.9 L_{dd} & L_{mq} &= 0.9 L_{qq} \\
 L_{ld} &= 0.1 L_{dd} & L_{lq} &= 0.1 L_{qq} \\
 a_i &= L_{md} / L_{di} & a_i &= L_{mq} / L_{qi} \\
 L'_{li} &= a_i^2 L_{ii} - L_{md} & L'_{li} &= a_i^2 L_{ii} - L_{mq}
 \end{aligned}
 \left. \begin{array}{l} \\ \\ \end{array} \right\} \text{for } i = D, F \quad \left. \begin{array}{l} \\ \\ \end{array} \right\} \text{for } i = G, Q$$

If the rated currents I_{jB} of the coils are given, then the reduction factors can be approximated by:

$$a_F \approx \frac{I_{FB}}{I_{dB}} \quad (\text{or } \frac{V_{dB}}{V_{FB}}) \Rightarrow \text{Find } L_{md} = a_F L_{dF} \Rightarrow \text{Find } a_D = L_{md} / L_{dD}$$

$$a_G \approx \frac{I_{GB}}{I_{QB}} \quad (\text{or } \frac{V_{QB}}{V_{GB}}) \Rightarrow \text{Find } L_{mq} = a_G L_{qG} \Rightarrow \text{Find } a_Q = L_{mq} / L_{qQ}$$

Consequently the main and leakage inductances can again be found from the formulas of case (a).

- (c) It is elucidating to see that the current-flux relation is for the d-axis coils:

$$\lambda_d = L_{ld} i_d + L_{md} (i_d + i'_F + i'_D)$$

$$\lambda'_F = L'_{lF} i'_F + L_{md} (i_d + i'_F + i'_D)$$

$$\lambda'_D = L'_{lD} i'_D + L_{md} (i_d + i'_F + i'_D)$$

and for the q-axis coils:

$$\lambda_q = L_{lq} i_q + L_{mq} (i_q + i'_G + i'_Q)$$

$$\lambda'_G = L'_{lG} i'_G + L_{mq} (i_q + i'_G + i'_Q)$$

$$\lambda'_Q = L'_{lQ} i'_Q + L_{mq} (i_q + i'_G + i'_Q)$$

- (d) It is re-emphasized that all parameters and variables of the excitation coils including the network to which they are connected, have to be reduced according to rules as explained earlier:

- * their voltages are to multiplied by the reduction factor.
- * their currents are to divided by the reduction factor.
- * their resistances and inductances multiplied by the square of the reduction factor.

The power coil variables and parameters remain unchanged in the reduction process.

Special Note on UM Type 4

Since this type has a three-phase excitation system, it does not directly fit the general discussion as held earlier, where all excitation coils are supposed to have magnetic shafts in line with the direct and quadrature axis. This is solved internally in the UM program by an extended Park transformation which in effect creates 3 equivalent power coils and 3 equivalent excitation coils: 2 zero coils which are decoupled from all other coils, the other 4 coils in the direct and quadrature axis each with 1 power coil and 1 excitation coil. The user of the program needs not to bother about this transformation, it is mentioned here to indicate that as a result the general comments made earlier hold and can be applied. Since however the induction machine is balanced in its design with respect to its three a, b, c phases, we will present the very simple conversion formulas here.

Let us use the following notation for the given self and mutual inductances of the machine.

L^{SS} = stator self-inductance

M^{SS} = mutual inductance between 2 stator coils

L^{RR} = rotor self-inductance

M^{RR} = mutual inductance between 2 rotor coils

M^{SR} = maximum value of mutual inductance between stator and a rotor coil of the same phase.

The power coils are the stator coils and the excitation coils are the rotor coils.

The main and leakage inductances as required by the UM can be obtained as follows.

(a) Realize first that the real a,b,c coils have to be transformed to equivalent o,d,q coils for both the stator and rotor side. The self and mutual inductances of these equivalent coils are:

* self inductance of stator o-coil: $L_0^{SS} = L^{SS} - 2M^{SS}$

* self inductance of rotor o-coil: $L_o^{RR} = L^{RR} - 2M^{RR}$

* self inductance of stator d-coil and stator q-coil:

$$L_d^{SS} = L_q^{SS} = L^{SS} + M^{SS}$$

* $L_d^{RR} = L_q^{RR} = L^{RR} + M^{RR}$

* mutual inductance between stator and rotor coils on the same

magnetic shaft (either d-or q-axis): $L_{dd}^{RS} = L_{qq}^{RS} = \sqrt{\frac{3}{2}} M^{SR}$

- (b) If the reduction factor a is given, then the conversion formulas to obtain the main and leakage inductances can be obtained by applying the general theory discussed earlier, to give:

$$L_{md} = L_{mq} = a \sqrt{\frac{3}{2}} M^{SR}$$

$$L_{\ell d}^S = L_{\ell q}^S = (L^{SS} + M^{SS}) - L_{md}$$

$$L_{\ell d}^{R'} = L_{\ell q}^{R'} = a^2 (L^{RR} + M^{RR}) - L_{md}$$

The variables supplied by a prime are reduced variables.

- (c) If the reduction factor is not given, the conversion formulas can be approximated by:

$$L_{md} = L_{mq} = 0.9 (L^{SS} + M^{SS})$$

$$L_{\ell d}^S = L_{\ell q}^S = 0.1 (L^{SS} + M^{SS})$$

$$a = (L^{SS} + M^{SS}) / (\sqrt{\frac{3}{2}} M^{SR})$$

$$L_{\ell d}^{R'} = L_{\ell q}^{R'} = a^2 (L^{RR} + M^{RR}) - L_{md}$$

- (d) All excitation variables have to be reduced in the same sense as described in previous discussion. It is to be noted that the zero excitation coil has to be reduced also. Thus: $L_o^{R'} = a^2 L_o^{RR}$

Special Note on DC Machines

For some of the types of DC machines the situation arises that we might not have both a power coil and an excitation coil on the same magnetic axis. In this case the partitioning into main and leakage flux can be made arbitrarily without any numerical consequences.

1.63 C Use of network representation of mechanical system:

Users of the U.M. module have the option to employ the network representation of the mechanical system. This network representation can then be handled by the Electrical Network section of the EMTF. This approach provides the means to use the efficient sparsity oriented solution method of the EMTF, in addition to its variable dimensioning feature. Moreover, no time-step delay is required in interfacing the U.M. module with the mechanical system. In determining the network representation of the mechanical system, the following correspondence of the parameters have to be considered:

* Moment of inertia of mass	=	capacitance
* Spring coefficient	=	1/inductance
* Damping coefficient	=	1/resistance
* Torque	=	current
* Speed	=	voltage

1.63 D Steady-state initialization:

Automatic initialization is available in the M₃₁ and higher versions of the EMTF.

(i) APPROACH FOR DATA INITIALIZATION

The 12 U.M. types as described in the EMTF Rule Book can be classified into three major classes of electric machinery: the synchronous, induction and direct current machines. The doubly-fed machines can be represented with either a synchronous or an induction machine type where both the stator and rotor are connected to external electric networks containing sources of the desired frequencies. All classes are currently subject to the common restriction that a completely correct solution of the steady-state initialization feature will result only if the electric network to which the power coils are connected, forms a linear and balanced network. This is since the current coding of steady-state initialization is limited to processing the positive sequence component only. If the network is nonlinear or unbalanced, then no program stop will occur. In this case the program simply runs from an incorrect initial condition and needs to run a number of integration steps before eventually settling down at the correct steady-state equilibrium. Future efforts might possibly include extension to the code in this respect, although it is felt that this work can be given a low priority due to the availability of the START AGAIN routine. Testing with an extreme case of unbalancy as described in Dr. Dommel's contribution to the IEEE Tutorial Course in Atlanta and Portland 1981, ($R_A = R_B = 1\Omega$, $R_C = 0.05\Omega$), shows that the steady-state equilibrium is established after about 20000 integration steps with a stepsize of 200 micro seconds. This corresponds with about one hour of wall clock time during heavy usage at day time with the VAX of BPA. Using the START AGAIN routine, then this one hour can be omitted for successive runs starting from the established correct steady-state equilibrium.

(a) Approach for synchronous and direct current machines.

In initializing the different U.M. types of synchronous and direct current machines, basically the approach is similar to the approach as followed by the Type-50 and Type-59 sources of the EMTF. The crucial data inputs that the user is requested to specify are the desired amplitude and angle of the terminal machine voltage.

In the principle the following steps are executed by the automatic initialization feature:

- (1) The electric network to which the power coils are connected, is provided with voltage sources reflecting the above-mentioned user's supplied data input. Solving the steady-state equations of this network establishes the currents of all power coils.
- (2) The current of the excitation (field) coil is adjusted such that the power coil currents and voltages match those as given from step (1).
- (3) The electromagnetic torque is found from the coil currents that are all known at this stage.
- (4) Sources in the network connected to the excitation coil and the sources in the mechanical network are adjusted to accommodate the excitation current and electromagnetic torque as found in steps (2) and (3).

Due to the variably dimensioning of the U.M. coils and the generality of the electric network connected to the excitation coil as well as the generality of the mechanical network, corresponding extensions to the approach of the Type-50 and Type-59 sources have to be implemented. Moreover, extensions to the described approach are also needed in order to insert transient reactances and processing of the negative sequence component if the influence of network unbalancy is desired to be taken into account.

(b) Approach for induction machines.

The approach as described in the previous section is not applicable to the steady-state initialization of induction machines. A brief explanation will now be given before outlining the approach that is to be followed. The basic reason is the fact that by the user's specification of the machine terminal voltage and by the execution of step (1), each machine power coil is impressed with a predetermined voltage, current as well as power factor. However, as opposed to synchronous and direct current machines, the required adjustment of the currents in the excitation (rotor) coils of step (2) is not possible due to the lack of external sources in the excitation (rotor) circuits. Neither is it possible to accommodate these required currents by a particular value of rotor speed. This can be understood from inspection of the circle diagrams of induction machines, reflecting the relation of stator and rotor phasor currents for all rotor speeds for a given stator terminal voltage.

The approach followed for the induction machine types of the U.M. is based upon requesting the user to specify any desired rotor speed he wants the machine to run with. This is instead of the request for terminal voltages as with synchronous and direct current machines. It is remarked that the program requires this speed to be specified in terms of the slip (in %), defined as:

$$\text{slip} = \frac{\omega_o - n_p \omega_m}{\omega_o} * 100 [\%]$$

with ω_o = angular frequency of the electric network to which the power (stator) coils are connected ($=2\pi * \text{STATFR}$)

n_p = number of pole-pairs

ω_m = angular speed of the rotor mass ($=2\pi * \text{RPM}/60$)

The slip is positive for motor operation and negative for generator operation.

Basically the following steps are executed by the automatic initialization feature for induction machines:

- (1) The program acquires the Thevenin voltages and impedances of the electric network to which the U.M. power coils are connected. These Thevenin parameters are transformed into the frequency domain of the internal U.M. equations (this frequency is different from the frequency of the electric network).
- (2) With the given slip, the frequency of the excitation coils and the connecting networks is known. The program acquires the Thevenin voltages and impedances of the networks.
- (3) Solution of all U.M. equations in the frequency domain establishes the currents of all coils, and thus all currents that have to flow into the various networks connected to the U.M.
- (4) With the found currents of step (3), the electromagnetic torque as well as the terminal voltages of all coils are easily obtained.
- (5) Sources in the mechanical network are adjusted to accommodate the electromagnetic torque as determined in step (4).

It is to be remarked that the procedure does not require any iteration to find the machine variables. By taking a positive or negative value for the slip that the user is requested to specify, the user is able to attain either a motor or a generator mode of operation for the machine. As obvious from the procedure, the loading or applied torque is adjusted to correspond with the chosen mode of operation. This capability to control the operation mode of the machine is highly desirable from the user's point of view.

(c) Approach for doubly-fed machines.

It was mentioned earlier that any synchronous or induction type of the U.M. can be used to represent a doubly-fed machine by connecting external sources of any desired frequency to both the stator and rotor side of the machine. For automatic initialization, however, the user is obliged to employ the induction types of the U.M. This will not result in a loss of generality at all.

As a consequence, for the automatic initialization of doubly-fed machines, the same approach as outlined in the previous section is taken. The user is requested to specify the rotor speed in terms of the slip as defined earlier. This determines the frequency of the rotor speed in terms of the slip as defined earlier. This determines the frequency of the rotor circuit and all machine variables based on the described approach. It is to be realized that the amplitude of any source in the electric network connected to the U.M. excitation coils (stator) and in the electric network connected to the U.M. excitation coils (rotor) can be freely set by the user with the EMTP Type-14 sources that are used for this purpose. As far as the frequencies are concerned, however only the frequency of the sources in the network connected to the stator coils will be accepted corresponding to the value as set by the user in the frequency argument of the used Type-14 sources. The frequency argument of all Type-14 sources in the electric network that is connected to the rotor coils can be set to any arbitrary positive value. The program simply ignores this specification and instead will set this frequency equal to the correct frequency of the rotor circuit as calculated from the steady-state condition with given stator frequency and the slip that the user was requested to specify. This steady-state condition for the frequency is the well-known relation:

$$n_p \omega_m + \omega_r = \omega_o$$

with ω_o = angular stator frequency

ω_r = angular frequency of rotor electric circuit

ω_m = angular speed of rotor mass

n_p = number of pole-pairs.

(ii) Rules for U.M. Automatic Initialization

It will be outlined in the next sections how to make use of the U.M. automatic steady-state initialization option. The following rules or restrictions need to be taken into consideration in using this option:

- (a) If a U.M. coil is connected to some network of the EMTP that contains a number of EMTP sources, then only the EMTP Type-14 sources are allowed to

be activated with $TSTART < 0$, and only these sources will be regarded in the initialization process. All other types of EMTP or TACS sources can only be included if they are activated at $TSTART > 0$. The frequencies of all EMTP Type-14 sources in one connected subnetwork needs to be of the same value. It is remarked that initialization of d.c. networks containing d.c. sources only happens if these d.c. sources are simulated by EMTP Type-14 sources with $TSTART < 0$ and all frequencies set to an adequately low value.

Note: Any U.M. mode is not allowed to be connected directly to an external EMTP source, insert a negligible small resistance as an approximation.

- (b) The automatic steady-state initialization option is only honored if the mechanical network representation feature is used (see EMTP Rule Book). In this electric network analog of the mechanical system, as many EMTP Type-14 sources to represent applied torques (currents) or speeds (voltages) are allowed to be activated at $TSTART < 0$. It is to be noted that in the steady-state this network is a d.c. network and the needed d.c. sources are to be simulated by the Type-14 source with the frequencies set to a proper and equal low value. As such they will all be regarded by the initialization process. However, the user is requested to specify at least one of these EMTP Type-14 sources to be adjustable in its amplitude. The value of this amplitude will be calculated by the program to accommodate the electromagnetic torque that the machine is supposed to produce. The user will be requested to specify the name of the mode to which this adjustable source is connected. If more than one source are declared to be adjustable, the ratios of the source amplitudes with respect to the amplitude of the first specified adjustable source can also be freely set. Thus, the demanded electromagnetic torque can be freely distributed over an arbitrary number of sources. It is remarked that due to the rule described in (a), TACS or other types of EMTP sources may be included to the network, provided that they are activated at $TSTART > 0$, and thus do not take part in the initialization process.

Note: The mode representing the mass of the electric machine is not to be connected directly to an external EMTP source, a negligible small resistance can be inserted if so desired.

- (c) Rule exclusively for synchronous and direct current machine types of the U.M.: Of all EMTP subnetworks connected to the different coils on the excitation side of the machine, only the subnetwork that is connected to the field coil, is allowed to have a non-zero EMTP Type-14 source with $TSTART < 0$. This field coil is to be identified with the first coil of the d-axis coils that are to be used. Since obviously this Type-14 source is to simulate a d.c. source, the frequency argument is to be set to an adequately low value. The amplitude can be set to any positive value, since the correct value will be calculated by the program to accommodate the field current that is needed to generate the desired terminal voltage of the machine. The user will be requested to specify

the name of the node to which this source is connected. It is remarked that other EMTF or TACS sources are allowed to be included, provided that they are all activated at TSTART > 0.

(iii) BENCHMARK DATA CASES

The M31 version of the EMTF includes two benchmark data cases for verification of the steady-state initialization. DCNEW1 is the benchmark data case of a U.M. Type-4 which is a 3-phase induction machine. The rotor in this data case is short-circuited to represent a squirrel cage rotor. The parameters of the machine corresponds to a practical machine with ratings: 2.541 MVA, 4.2 kV, 4 pole, breakdown torque about 80000 Nm at 24.3% slip.

The machine is connected on the power side to a simple network consisting of 3 lines and an infinite bus. Some external torque with sign and value to be determined by the automatic initialization feature, is applied to the rotor mass which is provided with some damping. Fig. 3 shows the output of some important machine variables from running the data case DCNEW1 for 1.80 seconds. The slip in the initialization specification card is set to + 2%, thus corresponding with motor operation. The steady-state is clearly established correctly. The results of a step increase to the external torque at 0.5 sec. is also shown.

DCNEW2 is the benchmark data case of a U.M. Type-1 which is a 3-phase synchronous machine. The rotor is provided with dampers in the direct and quadrature axes. The parameters of the machine correspond to a machine with rating: 160 MVA, 15 kV, 3600 RPM, 375 V excitation. The configurations of the electric network and the mechanical network are similar to those of DCNEW1. The initialization specification card contains the information about the desired machine terminal voltage which is set to 3030 V amplitude and 15° angle. This gives rise to generator operation of the machine due to the 3000 V amplitude of the infinite bus voltage.

Figure 4 shows the output from running DCNEW2 for 1.8 seconds. The results demonstrate that the steady-state initialization is performed correctly. A 3-phase fault is applied to the machine terminals at 0.3 sec. and cleared after 10 cycles. The corresponding transient behavior is well-known and can be verified to be correctly reproduced.

36 h-9

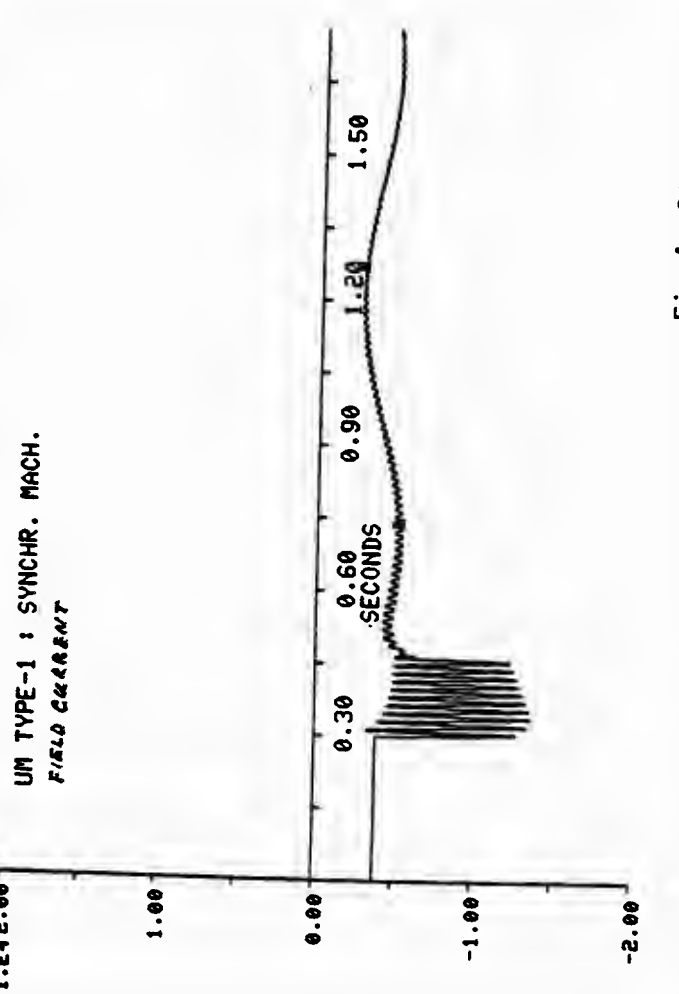
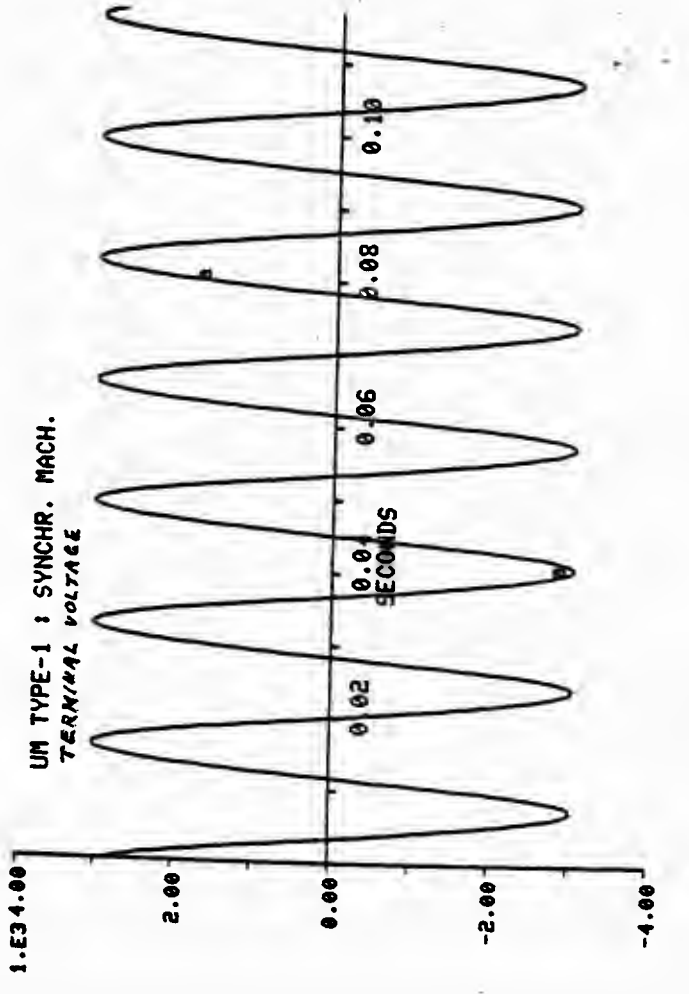
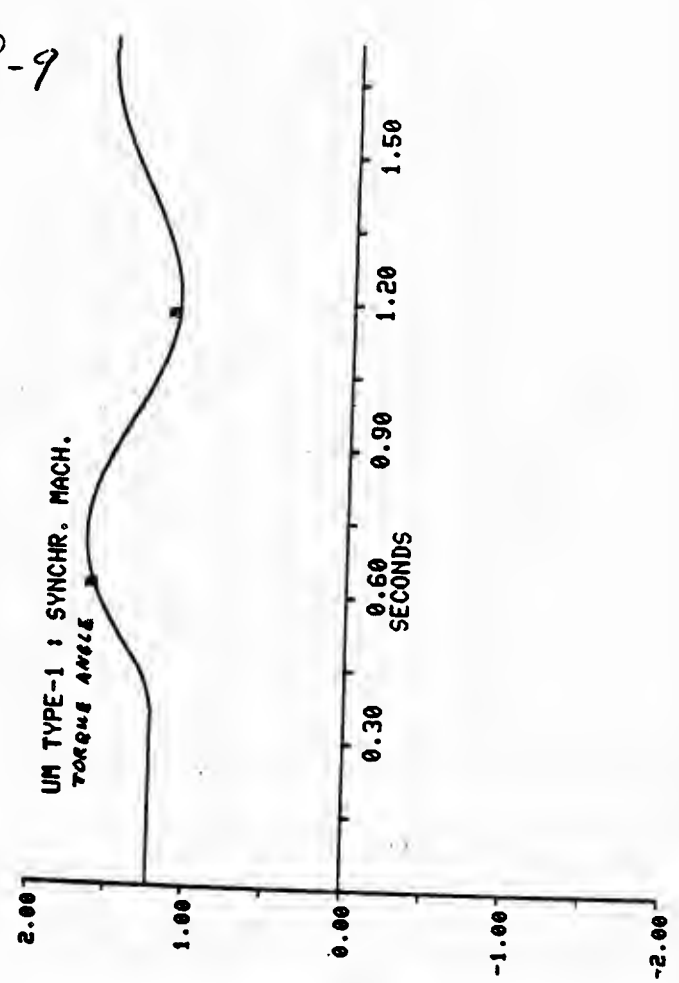
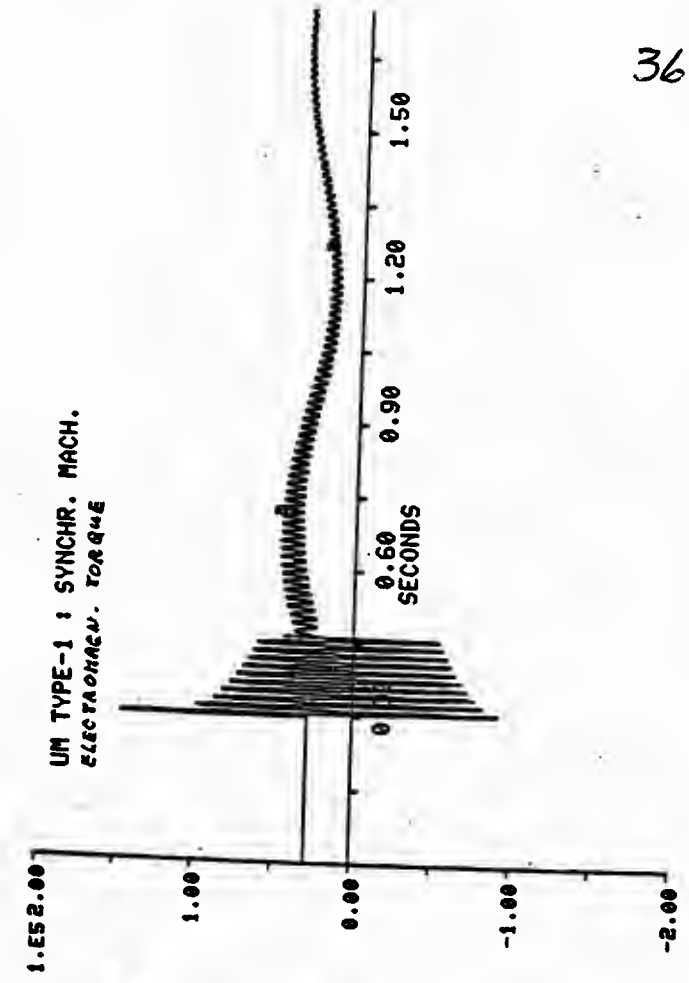
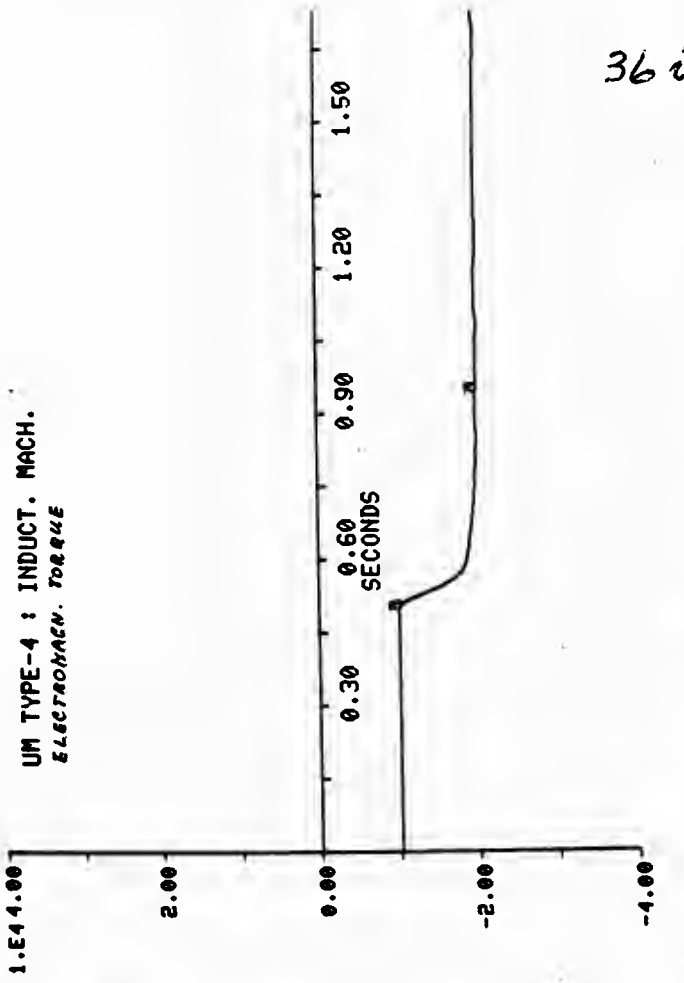

Fig.4 Steady-state and transient run of DCNEW2



36i

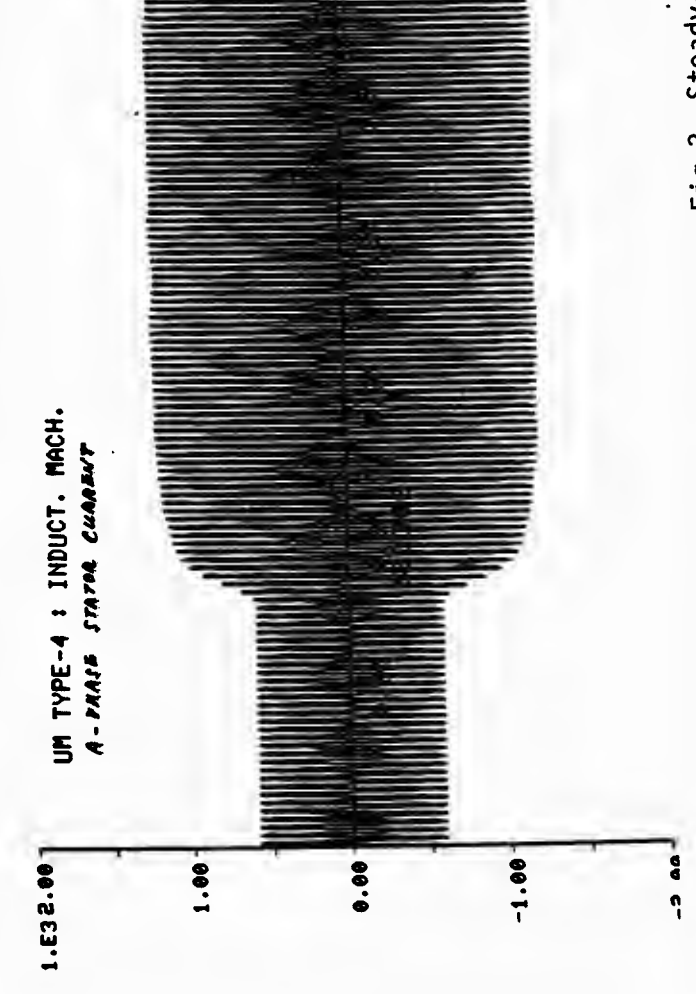
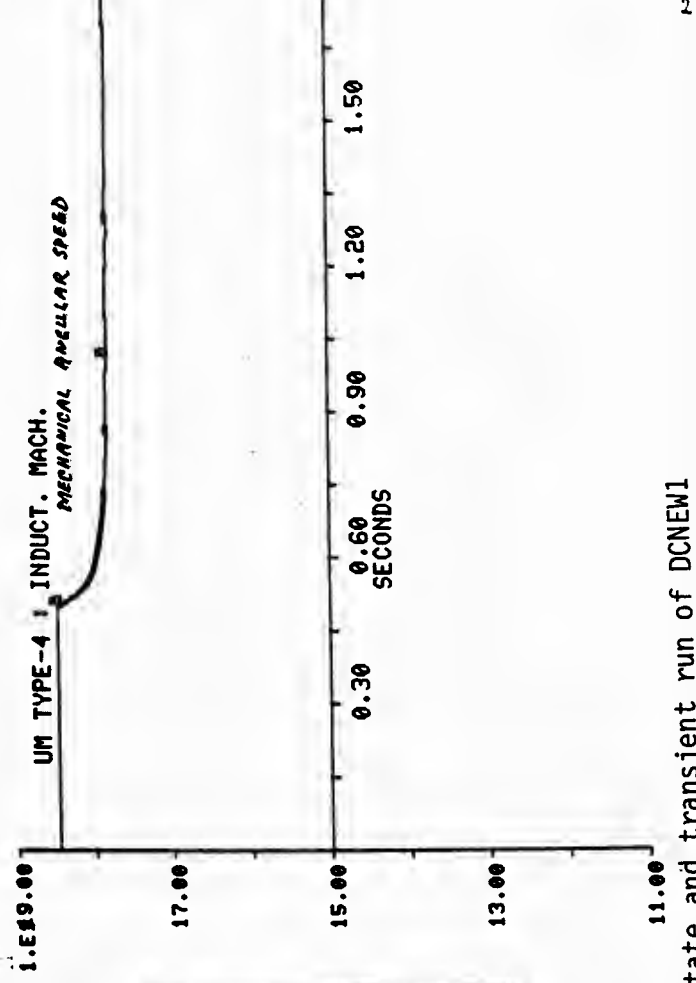
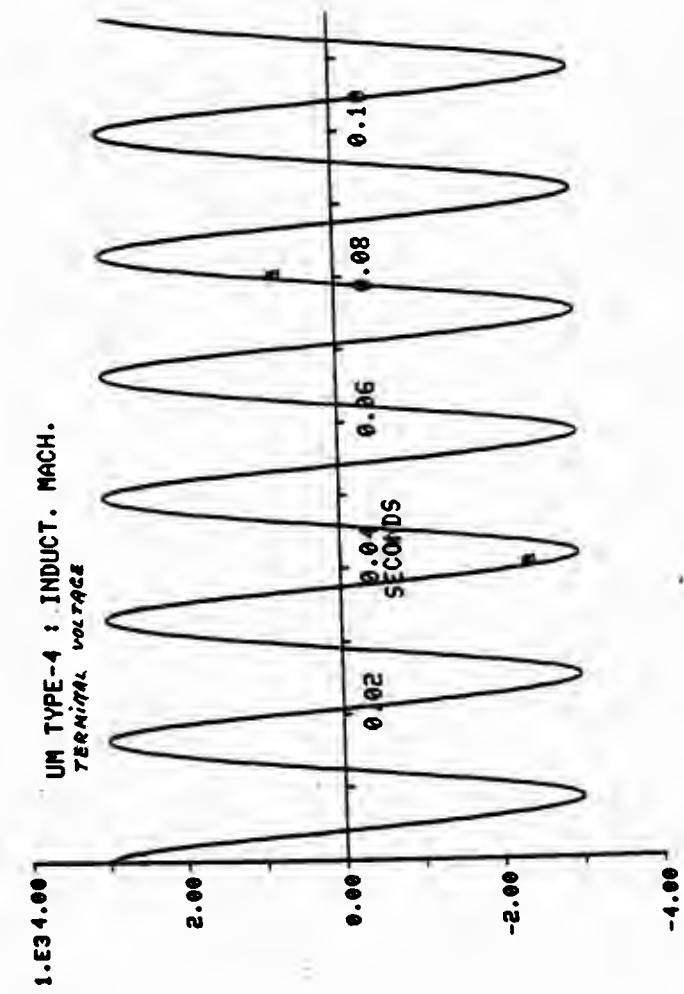

Fig.3 Steady-state and transient run of DCNEW1

1.63 E Saturation

To simulate the saturation effects, the U.M. approximates the saturation curve as two piecewise linear segments. The user can either include the saturation for the d-axis, or q-axis or for both axes. The saturation parameters for a d-axis saturation curve are FLXSD, LMUD and LMSD as indicated in Fig. 1. The q-axis saturation parameters are similarly defined:

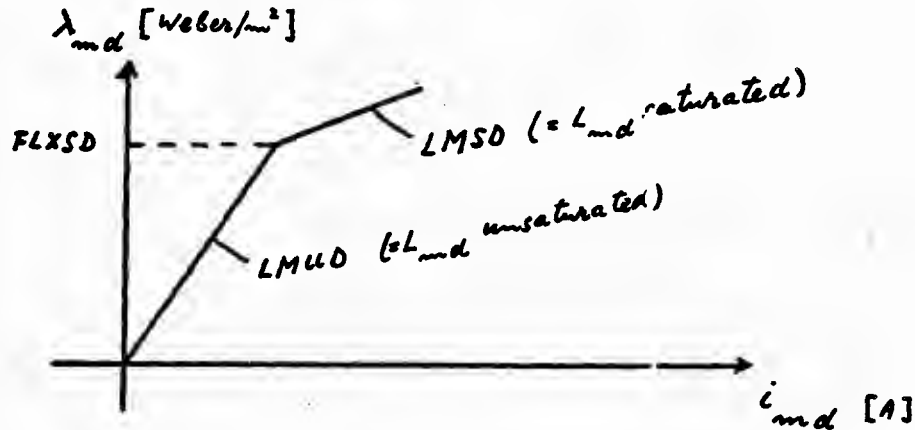

Fig. 1. Approximated d-axis saturation curve

These d-axis saturation parameters are to be specified on card (2) of the Class 2 U.M. data cards, the q-axis saturation parameters are similarly specified on card (3).

The decoupled approach of direct and quadrature axis saturation to the simulation of the saturation phenomenon works reasonably well for example with synchronous or direct current machines with a definite field coil in one axis. However, for the case that the electromagnetic circuit structures of both the stator and the rotor are symmetric as with most induction machines, this decoupled approach would lead to unacceptable results. Therefore, the U.M. in the M31 and higher versions of the EMTF is extended with a total saturation option.

1.63 F Residual Flux

In the M31 and higher versions of the EMTF, the U.M. module includes the residual flux option to the code. The 2-segment saturation curves for the d-axis, q-axis and total saturation are simply extended with one additional segment. Fig. 2 shows the saturation curve for the d-axis.

In addition to the usual saturation parameters FLXSD, LMUD and LMSD, the parameter FLXRD which is the d-axis residual flux, is required to be specified. For the q-axis the corresponding saturation and residual flux parameters are FLXSQ, LMUQ, LMSQ and FLXRQ.

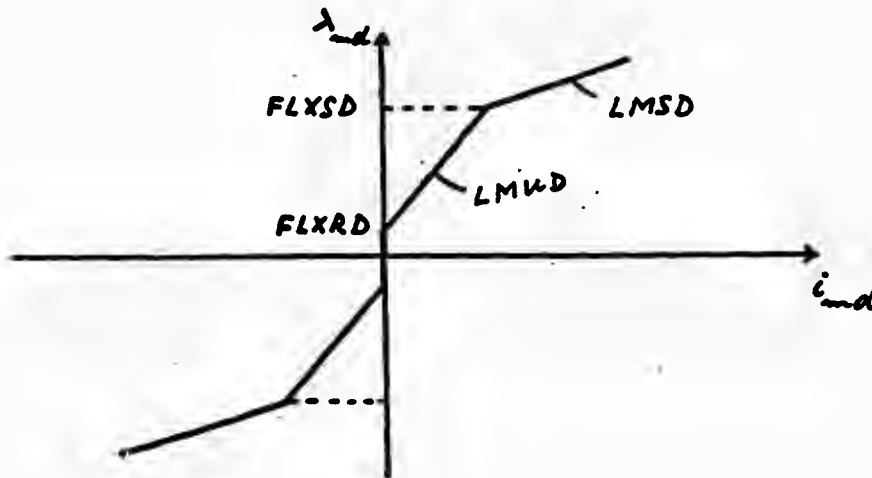

Fig. 2. Approximated d-axis saturation curve with residual flux FLXRD.

1.63G

USER'S GUIDE

This section contains the steps of action to be undertaken by the user to set up the data case for any of the 12 available U.M. types:

- Type 1 = synchronous machine, 3-phase power side
- Type 2 = synchronous machine, 2-phase power side
- Type 3 = induction machine, 3-phase power side
- Type 4 = induction machine, 3-phase power side and 3-phase excitation side
- Type 5 = induction machine, 2-phase power side
- Type 6 = single-phase a.c. machine, induction or synchronous, 1-phase excitation
- Type 7 = same as type 6 but 2-phase excitation
- Type 8 = d.c. machine, separately excited
- Type 9 = d.c. machine, series compound (long shunt)
- Type 10 = d.c. machine, series
- Type 11 = d.c. machine, parallel compound (short shunt)
- Type 12 = d.c. machine, parallel

Note: Except for Type 4, 6 and 7, all machine types can have an arbitrary number of d- and q-axis excitation coils. The 3-phase excitation axis of Type 4 are 120 degrees shifted.

(a) GENERAL FORMAT OF U.M. DATA CARDS

There are 3 classes of U.M. data cards, each class consisting of a number of cards.

Class 1 of the U.M. data cards reflects general common specifications regarding all U.M. machines.

Class 2 and Class 3 of the U.M. data cards contain the information for each U.M. machine to be used.

Class 2 can be regarded as to constitute the machine-table, specifying for instance the speed or the rotor moment of inertia of the machine. Class 3 constitutes the coil-table for which each card reflects the required parameter of a coil, for example the coil resistance value.

The U.M. data cards are to be placed behind all other used types of EMTP sources.

The general format of these U.M. data cards is as follows:

- (1) Other EMTP cards, including the request card for changing the default U.M. dimensions as explained elsewhere in this Rule Book.
- (2) Class 1 U.M. Data Cards (general specifications for all U.M. machines) consisting of 2 cards.
- (3) BLANK CARD ENDING CLASS 1 U.M. DATA
- (4) Cards of U.M.-1, an arbitrarily U.M. machine assigned to be machine number 1:

Class 2 U.M. Data Cards → 3 or more cards constituting the machine-table

Class 3 U.M. Data Cards → as many cards as the number of coils used

- (5) Cards of other U.M. machines to be included, with each machine specified in terms of Class 2 and Class 3 U.M. Data Cards (see (4)).
- (6) BLANK CARD ENDING ALL U.M. DATA
- (7) Other EMTP cards

(b) U.M. Type 1 User's Guide

U.M. Type 1 = synchronous machine, 3-phase power side, arbitrary number of excitation coils in d- and q-axis.

Step (1): Set up the general specification data cards according to the instructions of Class 1 U.M. Data Cards.

Step (2): Set up the machine-table data cards according to the instructions of Class 2 U.M. Data Cards.

Step (3): Set up the coil-table data cards according to the instructions of Class 3 U.M. Data Cards.

Exception to these instructions is with regard to the specification of the resistances and leakage inductances in the coil cards representing the power coils:

(a) Resistances of the power coils A, B and C are required to be equal to each other. If the case of non-equal resistances is desired to be studied, then the following valid strategy has to be followed. Insert to the U.M. equal resistances with values equal to the smallest resistance. Then account for the remaining resistances of the coils by connecting in the Electrical Network resistance branches in series to the U.M. coil. This is also a valid approach for studies of frequency dependency of the resistances.

(b) Specify for the leakage inductances LLEAK on the coil cards according to the rule:

on coil card A: LLEAK = total inductances of zero component

on coil card B: LLEAK = d-axis leakage inductance

on coil card C: LLEAK = q-axis leakage inductance

Note: If no zero component current flow is desired, then leave blank the resistance and inductance of coil A.

REMARK: These inductances can be found from the self- and mutual-inductances by applying a similarity transformation with the Park transformation matrix. See for example Fouad and Anderson, "Power System Control and Stability," Iowa State University Press, 1977, pp. 85-98.

(c) U.M. Type 2 User's Guide

U.M. Type 2 = synchronous machine, 2-phase power side, arbitrary number of excitation coils in d- and q-axis.

Step (1): Set up the general specification data cards according to the instructions of Class 1 U.M. Data Cards.

Step (2): Set up the machine-table data cards according to the instructions of Class 2 U.M. Data Cards.

Step (3): Set up the coil-table data cards according to the instructions of Class 3 U.M. Data Cards.

Exception to these instructions is with regard to the coil cards representing the power coils:

- (a) The 2-phase power coils have to be chosen as power coil B and C. Since power coil A is not used, the coil card representing power coil A is to be completely left blank.
- (b) Resistances and leakage inductances which have to be specified in the coil cards representing the power coils B and C, must follow the same instructions as outlined in Step (3) of U.M. Type 1 (except of course that reference to coil card of power coil A has to be disregarded).

(d) U.M. Type 3 User's Guide

U.M. Type 3 = induction machine, 3-phase power side, arbitrary number of excitation coils in d- and q-axis.

Step (1): Set up the general specification data cards according to the instructions of Class 1 U.M. Data Cards.

Step (2): Set up the machine-table data cards according to the instructions of Class 2 U.M. Data Cards.

Step (3): Set up the coil-table data cards according to the instructions of Class 3 U.M. Data Cards.

Exception to these instructions is with regard to the specification of the resistances RESIS and the leakage inductances in the coil cards representing the power coils. The instruction to be followed is outlined in Step (3) of U.M. Type 1.

(e) U.M. Type 4 User's Guide

U.M. Type 4 = induction machine, 3-phase power side and 3-phase excitation side.

Step (1): Set up the general specification data cards according to the instructions of Class 1 U.M. Data Cards.

Step (2): Set up the machine-table data cards according to the instructions of Class 2 U.M. Data Cards.

Exception to these instructions is with regard to the specification of NCLD and NCLQ for card (1), which both have to be left blank.

Step (3): Set up the coil-table data cards according to the instructions of Class 3 U.M. Data Cards, where rule numbers (3.2) and (3.3) have to be disregarded. Then additionally the following rules apply:

(a) Instead of the mentioned rules (3.2) and (3.3) pertaining to the arrangement of the excitation coil cards, the rule here is that the power coil cards have to be followed with excitation coil cards in the sequence of coil B, coil C and coil A. Note that the power coil cards are supposed to be arranged in the sequence of coil A, coil B and coil C according to rule number (3.1) of Class 3 U.M. data cards.

(b) Specify the resistances RESIS and the leakage inductances LLEAK on the coil cards representing the power coils A, B, C according to the same rules as outlined for Step (3) of U.M. Type 1.

(c) Same as (b) for the coil cards representing the excitation coils A, B, and C.

(f) U.M. Type 5 User's Guide

U.M. Type 5 = induction machine, 2-phase power side, arbitrary number of excitation coils.

Set up the data case for this type according to the same instructions as outlined for U.M. Type 2.

Note: Positive sequence for 2-phase systems is obtained by:

$$v_b = \hat{v} \sin wt$$

$$v_c = \hat{v} \sin (wt + 90)$$

This corresponds to positive sequence in 3-phase system:

$$v_a = \hat{v} \sin wt$$

$$v_b = \hat{v} \sin (wt - 120)$$

$$v_c = \hat{v} \sin (wt + 120)$$

(g) U.M. Type 6 User's Guide

U.M. Type 6 = single-phase a.c. machine, induction or synchronous, 1-phase excitation.

Step (1): Set up the general specification data cards according to the instructions of Class 1 U.M. Data Cards.

Step (2): Set up the machine-table data cards according to the instructions of Class 2 U.M. Data Cards.

Exception to these instructions is with regard to card (1) variables NCLD and NCLQ. Due to the internal U.M. coil arrangement, these variables have to be specified as:

NCLD = 1, NCLQ = leave blank or 1 if an auxiliary starting coil is desired.

Step (3): Set up the coil-table data cards according to the instructions of Class 3 U.M. data cards, but completely disregard rule number (3) about the sequence of coil cards belonging to one machine. Instead the following rules have to be followed:

- (a) First insert 2 blank cards.
- (b) Then comes the coil card representing the excitation coil. The current through this coil will be indicated in the output as IPC.
- (c) Now comes the coil card representing the power coil. If NCLD has been set equal to one, then this power coil card has to be followed with another coil card representing the auxiliary starting coil. The currents through the power coil and auxiliary coil will be indicated in the output as respectively IE_1 and IE_2 .

(h) U.M. Type 7 User's Guide

U.M. Type 7 = single-phase a.c. machine, induction or synchronous, 2-phase excitation.

The instructions to set up the data case are the same as for U.M. Type 6, except for rule (a) and (b) of Step (3), which now become:

- (a) First insert 1 blank card
- (b) Then comes 2 coil cards representing the 2 excitation coils, which are spatially 90 degrees shifted from each other. The currents through these excitation coils will be indicated in the output as respectively IPB and IPC.

(i) U.M. Type 8 User's Guide

U.M. Type 8 = d.c. machine, separately excited, arbitrary number of excitation coils in d- and q-axis.

Step (1): Set up the general specification data cards according to the instructions of Class 1 U.M. Data Cards.

Step (2): Set up the machine-table data cards according to the instructions of Class 2 U.M. Data Cards. In specifying NCLD and NCLQ on card (1) it is important to be aware of the fact that the power coil (armature coil) is on the q-axis. Thus usual wage of the machine is to arrange the excitation coils (field coils) on the d-axis.

Step (3): Set up the coil-table data cards according to the instructions of Class 3 U.M. Data Cards. Exception to these instructions is with regard to rule (3a), which instead must be replaced by the following rule:

- * First insert 2 blank cards, and then follow with the coil card representing the power coil (armature coil), which is located on the q-axis.

(j) U.M. Type 9, 10, 11, 12 User's Guide

U.M. Type 9 = d.c. machine, series compound (long shunt)
 Type 10 = d.c. machine, series
 Type 11 = d.c. machine, parallel compound (short shunt)
 Type 12 = d.c. machine, parallel

Step (1): Set up the general specification data cards according to the instructions of Class 1 U.M. Data Cards.

Step (2): Set up the machine-table data cards according to the instructions of Class 2 U.M. Data Cards.

Exception to these instructions is with regard to card (1) variables NCLD and NCLQ, which are to be specified as:

NCLD = 2, NCLQ = leave blank.

REMARK: This means that the number of excitation (field) coils are fixed, namely 2 in the d-axis.

Step (3): Set up the coil-table data cards according to the instructions of Class 3 U.M. Data Cards, but completely disregard rule number (3) about the sequence of coil cards belonging to one machine. Instead the following rules have to be followed:

- (a) First insert 2 blank cards.
- (b) Then comes the coil card representing the power (armature) coil. The U.M. considers this coil to be located on the q-axis.
- (c) Finally comes 2 coil cards representing the 2 excitation (field) coils which by the U.M. is considered to be located on the d-axis. The first of these 2 coil cards specifies a shunt coil and the second a series coil. If no shunt coil or no series coil is used, then the corresponding coil card is to be left blank completely.

Card (1) of Class 2 data cards:

JTYPE	NCLD	NCLQ	TQOUT	OMOUT	THOUT	Mech. Node Name	TACS	NPPAIR	RJ	DCOEF	EPSOM	FREQ
1						A6	A6	1	E14.5	E14.5	E14.5	E14.5

- JTYPE --- The U.M. type number desired to be used.
(1-2)
- NCLD --- Number of d-axis excitation coils.
(3-4) Note: For JTYPE = 4, NCLD is to be left blank.
- NCLQ --- Number of q-axis excitation coils.
(5-6) Note: For JTYPE = 4, NCLQ is to be left blank.
- TQOUT --- 0: no output request
1 torque is requested
2: torque and d-axis main flux are requested
3: torque, d-axis main flux and d-axis magnetizing current are requested.
- OMOUT --- Request for output of rotor speed [rad/sec]
0: no output request
1: speed is requested
2: speed and q-axis main flux are requested
3: speed, q-axis main flux and q-axis magnetizing current are requested.
- THOUT --- Request for output of angle indicating rotor position with respect to stator [rad]. For JTYPE = 1 and 2, this angle becomes the torque angle.
(9) 0 = no output, 1 = output requested.
- Mech. Node Name --- Name of the node to which the U.M. mass (= capacitor) is connected if mechanical network option is used, i.e., mechanical shaft system is represented by its electrical network analog. If this network option is not used, then leave the assigned space blank.
(10-15) Note that the U.M. sign convention corresponds with the generator convention. Thus for generator operation, a positive mechanical input is required.
- TACS --- Name of the TACS variable, which forms the mechanical input torque to the U.M., if the mechanical system is not simulated by an electrical network representation. Note that the U.M. sign convention is based on the generator convention. Thus for generator operation, a positive mechanical input torque is required.
(16-21) Note: Leave this assigned space blank if the mechanical network option is used.
- NPPAIR --- Number of pole pairs.
(22-23)
- RJ --- Rotor moment of inertia in [N.msec²/rad] or in per unit.
(24-37) Leave blank, if mechanical network option is used.
- DCOEF --- Dampings coefficient in [N.m.sec/rad] or in [per unit]. Leave blank if mechanical network option is used.
(38-51)
- EPSOM --- Convergence margin for the rotor speed iteration process.
(52-65) If left blank, then by default EPSOM = 0.01% of synchronous speed or rated speed for DC machines.
- FREQ --- Specify the steady state frequency of the network to which the power coils of the machines are connected. If left blank, a default value = STATFR (defined in the module "SYSDEP") will be taken.
(66-79)

Card (2) of Class 2 data cards:

OMEGM	LMUD	JSATD	LMSD	FLXSD	FLXRD
E 14.5	E 14.5	1	E 14.5	E 14.5	E 14.5

- OMEGM --- Initial condition of the mechanical speed in [rad/sec] or in (1-14) [per unit].
- LMUD --- Unsaturated d-axis main inductances in [H] or in [per unit]. (15-28)
- JSATD --- Request for implementation of d-axis saturation if JSATD is set to 1. Leave blank if no d-axis saturation is desired. Set to 5 if total saturation is desired as an option. (29)

REMARK: The quantities following JSATD in the data card can be all left blank if no d-axis saturation is desired. Otherwise these quantities pertain to specifications of the d-axis saturation curve as discussed in the section about U.M. saturation.

It is to be noted that obviously -

LMUD = slope of curve in unsaturated part
 LMSD = slope of curve in saturated part

- LMSD --- Leave blank if no d-axis saturation is desired. Otherwise, (30-43) see REMARK pertaining to JSATD and Fig. 1.
- FLXSD --- Leave blank if no d-axis saturation is desired. Otherwise, (44-57) see REMARK pertaining to JSATD and Fig. 1.
- FLXRD --- Leave blank if option for residual flux was not requested. (58-71) Otherwise, punch the desired value of the d-axis residual flux, or the residual flux for total saturation.

Card (3) of Class 2 data cards:

THETAM	LMUQ	JSATQ	LMSQ	FLXSQ	FLXRQ
E 14.5	E 14.5	1	E 14.5	E 14.5	E 14.5

- THETAM --- Initial condition of rotor position with respect to stator (1-14) in mechanical [rad]. For synchronous machines, i.e. JTYPE = 1 and 2, this angle is the torque angle in electrical [rad].
- LMUQ --- Unsaturated q-axis main inductance in [H] or in [per unit]. (15-28)
- JSATQ, --- All these quantities can be left blank, if total saturation or LMSQ, FLXSQ, no q-axis saturation effects is desired. Otherwise, since (29-71) these q-axis saturation quantities are completely analog in their meaning with those of the d-axis, i.e., JSATD, LMSD, FLXSD, please consult card (2) where these quantities are documented.

36 j-2

FLXRQ --- Punch the desired value of the q-axis residual flux if
(58-71) residual flux option was requested, leave blank otherwise.
Leave also blank if total saturation option was requested.

Card (4) of Class 2 data cards:

This card is to be omitted if no automatic steady-state initialization was requested for (INITUM in Class 1 data cards).

1	2	3	4	5	6	7	8	9	10	11	12	13	14	15	16	17	18	19	20	21	22	23	24	25	26	27	28	29	30	31	32	33	34	35	36	37	38	39	40
AMPLUM														ANGLUM														BUSF				BUSM							
E14.5														E14.5														A6				A6							

- AMPLUM --- (a) If synchronous or direct current machine, specify the amplitude of the terminal voltage of the machine at the power side.
(1-14) (b) If induction or doubly-fed machine, specify the slip (in %)
- ANGLUM --- (a) If synchronous machine, specify the phase angle (in degrees) of the terminal voltage of the machine as the power side. For 3-phase machines, this angle is the voltage angle for power coil A, angles of power coils B and C is taken respectively as lagging and leading with 120 degrees. For 2-phase machines, this angle is the voltage angle for power coil B, angle of power coil C is taken as leading with 90 degrees.
(15-28) (b) If no synchronous machine, leave this space blank.
- BUSF --- (a) If synchronous or direct current machine, specify the node name of the EMTP Type-14 source that is desired to be adjusted by the program in order to accommodate the steady-state field current. This field coil is required to be identified with the first d-axis excitation coil.
(29-34) (b) If induction or doubly-fed machine, leave this space blank.
- BUSM --- Specify the node name of the EMTP Type-14 source in the mechanical network that is desired to be adjusted by the program to accommodate the steady-state electromagnetic torque. If more adjustable sources are desired, then see card (5).
(35-40)

Card (5) and higher of Class 2 data cards:

These cards are to be omitted if no card (4) is used. Otherwise for each additional EMTP Type-14 source of the mechanical network that is desired to be adjusted by the program to accommodate the total electromagnetic torque, a card of the following format is required.

- MORE --- This is to be typed on column 1-4.
 (1-4)
 BUSM --- Same meaning as BUSM on card (4).
 (35-40)
 DISTRF --- Enter the ratio of the value of this adjustable EMTP Type-14
 (41-54) source and the value of the adjustable source BUSM as specified on card (4); also supply a negative sign if of opposite polarity.

(m) Class 3 U.M. data cards (Coil-table):

The Class 2 U.M. data cards have to be followed immediately with the U.M. Class 3 data cards. Each card of this class we will refer to as a coil-card in which all information about one single coil has to be specified. (That is why U.M. Class 3 data cards really form a coil-table.) The data format of a coil card is as follows:

1	2	3	4	5	6	7	8	9	10	11	12	13	14	15	16	17	18	19	20	21	22	23	24	25	26	27	28	29	30	31	32	33	34	35	36	37	38	39	40	41	42	43	44	45	46	47	48	49	50
R E S I S					L L E A K					B U S 1		B U S 2		X T A C S		C U R O U T	C U R																																
E 1 4 . 5					E 1 4 . 5					A 6		A 6		A 6			E 1 4 . 5																																

- RESIS --- Resistance in [Ω] or in [per unit].
 (1-14)
 REMARK: RESIS cannot be taken equal to 0.
 LLEAK --- Leakage inductance in [H] or in [per unit].
 (15-28)
 BUS1 --- Node name of the Electrical Network to which one terminal
 (29-34) of the coil is connected. Leave blank if local ground connection or no connection with the Electrical Network is desired.
 BUS2 --- Node name of the Electrical Network to which the other
 (35-40) terminal of the coil is connected. Leave blank if local ground connection or no connection with the Electrical Network is desired.
 XTACS --- Name of TACS variable, which is used as a voltage source
 (41-46) in series with the coil.
 CUROUT --- Request for output of the coil current if set to 1; leave
 (47) blank if no output is desired. If set to 2, then the power coils are requested to provide their current output in the Park domain, i.e., i_o , i_d , i_q .
 CUR --- Initial condition of the coil current in [A] or in [per unit].
 (48-61) Leave blank if automatic steady-state initialization is requested for (see INITUM of Class 1 data cards).

General Rules with respect to the coil cards:

- (1) The following sign-convention has to be realized in assigning BUS1, BUS2, XTACS and CUR

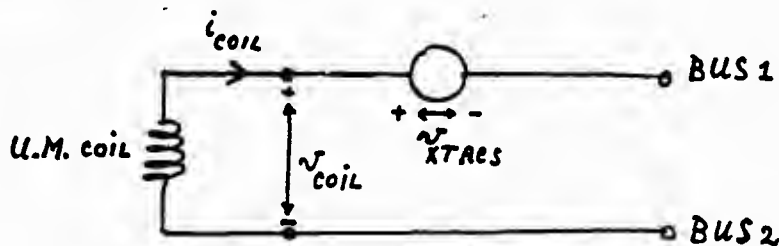

36j-4

Thus: *Positive coil current means that it goes from
 BUS2 to BUS1
 *The terminal coil voltage is:

$$v_{\text{coil}} = v_{\text{BUS1-BUS2}} + v_{\text{XTACS}}$$

(2) The coil cards specifying the coils of one machine follow immediately the Class 2 U.M. data cards of the machine.

(3) With respect to the sequence of coil cards belonging to one machine, the following rules apply:

3.1 First comes 3 mandatory coil cards representing the power coils in the sequence of coil A, coil B and coil C. If less than 3 power coils is needed, then insert blank cards for the nonused coils.

3.2 Then comes NCLD coil cards representing the d-axis excitation coils, with the value of NCLD as specified in the machine-table (see Class 2 U.M. data cards).

REMARKS: No coil nor blank cards are to be inserted if NCLD = 0.

3.3 Finally comes NCLQ coil cards representing the q-axis excitation coils, with the value of NCLQ as specified in the machine-table.

REMARKS: No coil cards nor blank cards are to be inserted if NCLQ = 0.

(4) If the option for full compensation is requested, than all U.M. machines to be used have to be electrically separated from each other. The "stub line" strategy can be applied. This restriction is not present if the prediction option is requested (See Class 1 U.M. data cards).

* The power coils can be all connected to each other in one electrical network, but cannot be connected to the excitation coils. Again use stub line or TACS element to avoid this restriction.

* Only the first three excitation coils can be connected to one and another in one electric network;

36j-5

if more than three excitation coils are used, then excitation coil number 4 and higher must be completely disconnected from each other. This restriction can be avoided also by using a stub line or a TACS element.

- (5) Provide a blank termination card behind the last coil card of the last machine, indicating the termination of all U.M. data cards.

(n) Output Labels

All U.M. output are labeled by two names:

- * Upper label indicates the machine number
- * Lower label indicates the corresponding variable.

Example: UM-4 UM-4
 TQGEN IPA

The U.M. variables which can be requested for output are:

TQGEN --- Electromechanical torque based on generator convention in [per unit] or [N.m]. If motor, TQGEN is negative; if generator, TQGEN is positive.
OMEGM --- Mechanical rotor speed in [rad/sec].
THETAM --- Mechanical rotor angle [rad]; for Type 1 and 2 (synchronous machine) this angle is the torque angle [rad].
IPA, --- Currents of the power coils A, B and C in [per unit]
IPB, IPC or [A].

Note: *For all types of direct current machines, the power (armature) coil current is indicated by IPC.

*For U.M. Types 6 and 7 (= single phase a.c. machines, see their User's Guide), these labels indicate excitation currents.

IE₁, --- Currents of the excitation coils in [per unit] or [A].
IE₂,
etc.

Note: *For U.M. Type 4 (induction machine, 3-phase stator and rotor), the 3-phase rotor currents in coils B, C, and A are respectively indicated by IE₁, IE₂, IE₃.

*For U.M. Types 6 and 7 (single-phase a.c. machines, see their User's Guide), these labels indicate the power coil currents.

IPO, --- Currents of the power coils in the Park Domain (reference
IPD, IPQ frame which is stationary relative to rotor).

FLUXMD, FLUXMQ --- Magnetic fluxes in the d- and q- axis respectively.

IMD, IMQ --- Magnetizing currents in the d- and q- axis respectively.

TPIM-2

II USER INSTRUCTIONS FOR U.M. MODELING OF INDUCTION MACHINE**A.** Data Applicable to the Problem as a Whole

The U.M. tables are stored within the total allocation of List 25 of EMTP variable dimensioning. Make sure that the EMTP has been link-edited (loaded) with non-unity storage for this working area. Recall that the first line on page SRFH-5 showed 317 cells used for that synchronous machine of the first test. Having a fully virtual machine (the VAX) at BPA, we are overlay generous, and will never have a problem (3700 cells are presently allocated).

The first data card belonging to the U.M. is a request for the allocation of List 25 storage among Hian's four different tables. This card must precede the miscellaneous data cards, and should follow the BEGIN NEW DATA CASE card that begins the data case. Within those limits, ordering is immaterial (all such special-request cards at the front can come in any order). Using free-format, we have:

1	2	3	4	5	6	7	8	9	10	11	12	13	14	15	16	17	18	19	20	21	22	23	24	25	26	27	28	29	30	31	32	33	34	35	36	37	38
ABSOLUTE U.M. DIMENSIONS, I, J, K, L																																					

where "I", "J", "K", and "L" are symbols for explicitly-punched integers having the following meaning:

- I --- maximum total number of coils (for all machines)
- J --- maximum number of machines
- K --- maximum number of U.M. outputs (total for all machines)
- L --- maximum number of U.M. 6-character names (total for all machines)

All machine data is grouped together, and should follow the last conventional (non-dynamic) EMTP source card, just as is the case with the existing production S.M. modeling. The beginning of U.M. data is signaled by two data cards:

Card 1 : Punch "19" in columns 1-2, as a special request for U.M. modeling. The rest of the card is left blank.

Card 2 : Punch column 1 with a flag which indicates whether or not data is to be in per unit:

- $\left\{ \begin{array}{l} 1 \Rightarrow \text{input data is in per unit.} \\ 0 \Rightarrow \text{input data is in physical units (ohms, volts, amperes, henries). A blank produces the same effect as an explicitly-punched zero.} \end{array} \right.$

There is nothing else on this second card (leave columns two through 80 blank).

Card 3 : Blank card to indicate the end of the general specifications for all U.M.'s to be used.

B. Data Cards for Machine Table of U.M.

TPIM-3

Next (after Card 2 of Section A) come all data cards for Hian's Machine Table, three cards for each U.M. component (for each induction machine, in this case).

Call these three cards Card A, Card B, and Card C, respectively. Format requirements are:

- Card A :
- JTYPE ---- Columns 1-2, format I2 . Type code. Punch with "4" for 3-phase induction machine with 3-phase rotor.
 - NCLD ---- *cols. 3-4*
 - NCLQ ---- *cols. 5-6*
 - JTQOUT ---- Column 7, format I1 . Flag for the request of output of the electromechanical torque TQGEN . Punch with "1" for such output; leave blank or punch with zero to suppress it.
 - JOMOUT ---- Column 8, format I1 . Like JTQOUT , only for the mechanical speed ω_m in radians/second .
 - JTHOUT ---- Column 9, format I1 . Like JTQOUT , only for the mechanical angle θ_m in radians .
 - SHAFT ---- Columns 10-15, format A6 . Name of the electric network node which represents the rotor mass (remember the use of electrical analog).
 - NPPAIR ---- Columns 22-23, format I2 . Number of pole pairs of the machine (e.g., "2" for 1800 rpm at 60 Hz with zero slip).
- Card B :
- $\omega_m(0)$ ---- Columns 1-14, format E14.5 . The initial mechanical speed (at time zero), in radians/sec.
 - L_{md}^U ---- Columns 15-28, format E14.5 . The unsaturated value for the main (i.e., non-leakage) d-axis inductance, in units of Henries .
- Card C :
- $\theta_m(0)$ ---- Columns 1-14, format E14.5 . The initial mechanical angle (at time zero), in radians .
 - L_{mq}^U ---- Columns 15-28, format E14.5 . The unsaturated value for the main (i.e., non-leakage) q-axis inductance, in units of Henries .

C. Data Cards for Coil Table of U.M.

After the Machine Table data of Section B, the user must supply data cards for the Coil Table of the U.M. For the 3-phase induction machine being considered, there are six such cards for each machine. If more than one machine, ordering of these groups of six cards must correspond to the machine ordering of Section B. There is a blank terminator card after the last such set-of six data cards for the final machine. Of the six data cards, the first three are for the power circuit (armature of the conventional induction machine), and the final three are for the excitation circuit (rotor of conventional induction machine). The symbolic parameter content is (see next page):

Card 1:	R_0	L_0	1a	} 36 k-2	TPIM-4
Card 2:	R_d	L_{dl}	1b		
Card 3:	R_g	L_{gl}	1c		
Card 4:	R_d	L_{dl}	1b	} Power side, in (a, b, c) order, note.	
Card 5:	R_g	L_{gl}	1c		
Card 6:	R_0	L_0	1a		

This shows the order of the cards, and the symbolic association of the three floating-point parameters on each data card; it does not show the data format of a typical card, however, which is as follows:

R, L ----- Columns 1-28, format 2E14.5 .

BUS1 } ----- Columns 29-40, format 2A6 . These are the EMTP
 BUS2 } node names for the terminal connections of the coil. Two blank names imply a shorted coil (both ends connected to ground). For an open circuit, leave one name blank and punch the other with the name of a dummy EMTP node that has a high impedance connected to ground.

TACS ----- Columns 41-46, format A6 . This is the name of a TACS variable whose value is to give the value of a voltage source connected to the coil (see sketch).

JCLOUT ----- Column 47, format I1 . This is a request flag for output of the coil current (see sketch as to the sign convention). Leave blank for no such output; punch "1" in column 47 to produce it.

CUR ----- Columns 48-61, format E14.5 . This is the initial current (value at time zero) in amperes .

The blank card which terminates this Coil Table data is also the last U.M. data card. Then comes the blank card ending EMTP sources, and the rest of the data case is quite conventional.

D. Modeling of the Shaft System

The masses and springs that are built into the production S.M. model are explicitly represented in U.M. modeling by an electrical analog. For each rotor mass, there is a capacitor to ground; for each spring interconnecting rotor masses, there is an inductor between the capacitor nodes. Applied (load) torque becomes injected current into such a capacitor node. Etc. as per the following correspondence:

<u>Mechanical quantity</u>	<u>Electrical quantity</u>
T (torque on mass)	i (current into node)
ω_m (angular speed)	v (node voltage)

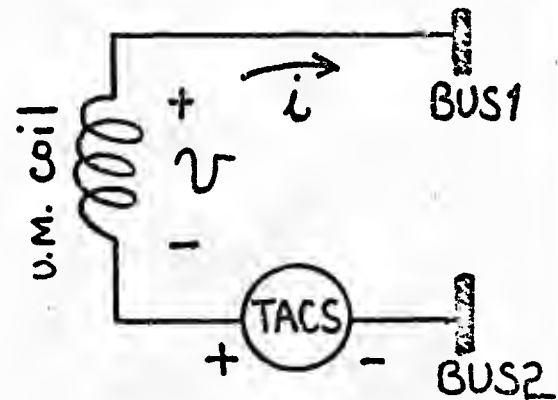
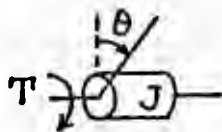
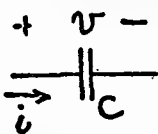

Fig. 1. Signs of coil current and voltages.

θ_m (angle)	q (capacitor charge)
J (moment of inertia)	C (capacitance to ground)
K (spring constant)	$1/L$ (reciprocal of inductance)
D (viscous damping)	$1/R$ (conductance)



$$T = J \frac{d^2\theta}{dt^2} = J \frac{d\omega}{dt}$$



$$i = C \frac{dv}{dt}$$

$T \sim i$	$J \sim C$
$\omega \sim v$	$K \sim 1/L$
$\theta \sim q$	$D \sim 1/R$

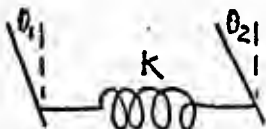

$$T = K(\theta_1 - \theta_2) = K \int^t (\omega_1 - \omega_2) dt$$

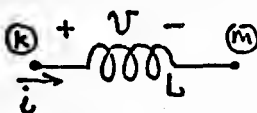

$$i = \frac{1}{L} \int^t (v_k - v_m) dt$$

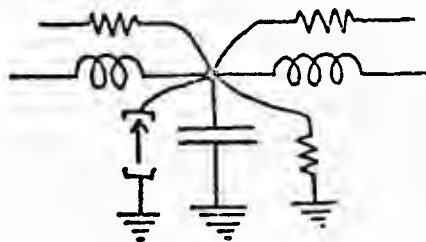

$$T = D\omega$$

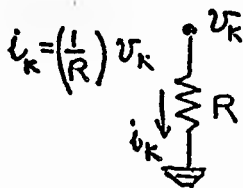

$$i_k = \left(\frac{1}{R}\right) v_k$$

Summarizing this in words, then, the user does the following. For each mass of the shaft system, he defines an electric network node with a capacitor of value J (the moment of inertia) to ground. If there is absolute-speed damping on this mass, he parallels the capacitor with a resistor having conductance D (the viscous damping constant). If there is an externally applied mechanical torque such as a mechanical load on this mass, he parallels the capacitor with a current source of value $T_{mech}(t)$ (the time-dependent mechanical torque). The sign is such that a mechanical load becomes a negative injection. If there are two or more masses, one adds an inductor connecting the associated adjacent capacitors; value of the inductance is $1/K$ (reciprocal of the spring constant connecting the two masses). If there is speed-deviation damping associated with this coupling, the inductance is paralleled by a conductance of value $DMUT$ (the viscous damping constant of this effect). There is no element representing the U.M. driving torque, since the EMTP provides this connection automatically. In terms of EMTP mathematics, the U.M. driving torque looks like a hidden nonlinear element which is connected from ground to the node of the capacitor that represents the rotor mass of the U.M. Hence do not expect the currents in branches that are connected to this node to sum to zero, for one branch is hidden. As for output of such mechanical variables, they are handled by column-80 requests on the branch cards representing the series R-L-C elements that are used. Remember that shaft torques are inductor currents, node voltages are mechanical speeds, etc. If mechanical angles are wanted, one can pass the node voltages into TACS and integrate. Etc., etc.

Hian has set up a very nice little illustration of the induction machine mode of U.M. modeling. As can be confirmed by the EMTF data listing below, there is a 3-phase infinite bus (BUS-A0, BUS-B0, BUS-C0) which has "a"-phase at 180 volts, zero degrees, and 60 Hz. Series R-L branches with $R = .005$ and $L = 1.E-3$ henry connect this bus to the armature terminals (BUS-A1, BUS-B1, BUS-C1). For purposes of connectivity, the infinite bus is connected to ground by three resistors of value 1.0 ohm (the first three branch cards). Rotor windings are grounded-ye, with the ungrounded ends connected to the 3-phase electrical bus (BUSRA1, BUSRB1, BUSRC1), which in turn is grounded by three resistors of value 1.E-10 ohm. Thus the rotor windings are effectively short-circuited. As for the mechanical side, node BUS-OM has capacitor $C = .06$ farad to ground representing the mass, and a parallel resistor $R = 33.333$ ohm to ground representing viscous damping. The machine starts from zero speed, with all coil currents equal to zero. The Type-11 current source on node BUS-OM (value 1 = -6.0 amps) represents the mechanical load. Because there are two pole-pairs (NPPAIR = 2), synchronous speed is 60 times P_1 , or 188.4955 radians/sec.

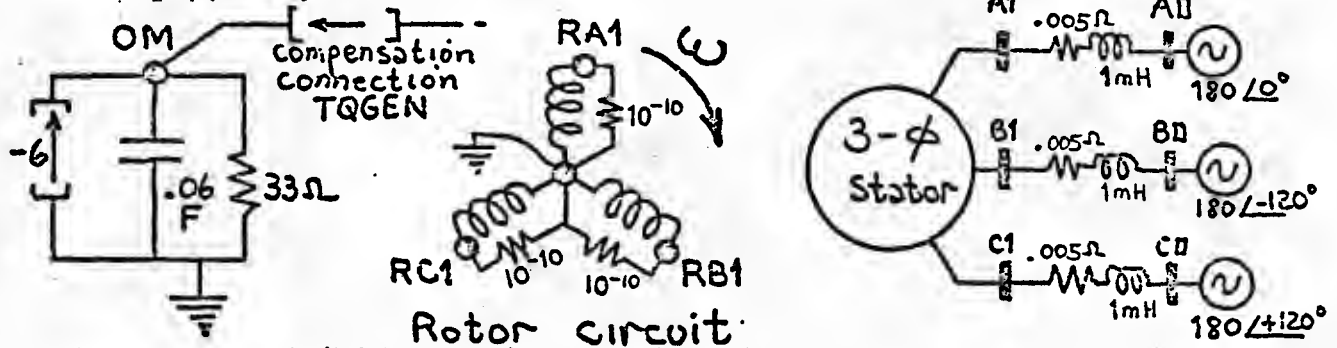

DATE (MM/DD/YY) AND TIME OF DAY (HH:MM:SS.) = 04/26/80 12.23.51 ANY PLGTS BEAR SAME FIGURES. VERSION = "427."

IF IN DOUBT AS TO WHAT THE FOLLOWING PRINTOUT MEANS, CONSULT THE 564-PAGE EMTF USER'S MANUAL DATED NOVEMBER, 1977.

INDEPENDENT LIST LIMITS FOLLOW. TOTAL LENGTH OF /LABEL/ EQUALS 200123 INTEGER WORDS. 703 1050 2500 30 9500

125	6100	5000	50	300	100	140	5	9000	400	9	4	30	6000	500	72	200	3000	6	3700
-----	------	------	----	-----	-----	-----	---	------	-----	---	---	----	------	-----	----	-----	------	---	------

DESCRIPTIVE INTERPRETATION OF NEW-CASE INPUT DATA | INPUT DATA CARD IMAGES PRINTED BELOW, ALL 80 COLUMNS, CHARACTER BY CHARACTER.

0	1	2	3	4	5	6	7	8
0	0	0	0	0	0	0	0	0

MARKER CARD PRECEDING NEW DATA CASE. | BEGIN NEW DATA CASE

U.M. TABLE SIZES.	20	2	50	100
MISC. DATA.	0.200E-03	0.500E+00	0.000E+00	0.000E+00
MISC. DATA.	1	1	0	0
PRINTOUT	1	1	20	20

COMMENT CARD. | FOLLOWING 3 BRANCHES ARE FOR CONNECTIVITY TO GROUND.

SERIES R-L-C.	0.100E+01	0.000E+00	0.000E+00	1	0	BUS-A0	1.0
SERIES R-L-C.	0.100E+01	0.000E+00	0.000E+00	1	0	BUS-B0	1.0
SERIES R-L-C.	0.100E+01	0.000E+00	0.000E+00	1	0	BUS-C0	1.0

COMMENT CARD. | NEXT COMES THE SOURCE IMPEDANCE (UNCOUPLED R-L BRANCHES).

SERIES R-L-C.	0.500E-02	0.100E+01	0.000E+00	1	0	BUS-A1BUS-A0	0.005 1.0
REFERENCE BRANCH.	COPY	"BUS-A1"	TO	"BUS-A0"	1	0	BUS-B1BUS-B0BUS-A1BUS-A0
REFERENCE BRANCH.	COPY	"BUS-A1"	TO	"BUS-A0"	1	0	BUS-C1BUS-C0BUS-A1BUS-A0

COMMENT CARD. | NEXT SHORT CIRCUIT THE ROTOR WINDINGS WITH NEAR-ZERO RESISTANCE.

SERIES R-L-C.	0.100E-09	0.000E+00	0.000E+00	1	0	BUSRA1	1.E-10
SERIES R-L-C.	0.100E-09	0.000E+00	0.000E+00	1	0	BUSRB1	1.E-10
SERIES R-L-C.	0.100E-09	0.000E+00	0.000E+00	1	0	BUSRC1	1.E-10

COMMENT CARD. | FINAL BRANCHES ARE FOR ROTOR MASS (CAPACITANCE) AND DAMPING (RESISTOR)

SERIES R-L-C.	0.000E+00	0.000E+00	0.600E+05	1	0	BUS-DM	6.00E4
SERIES R-L-C.	0.333E-02	0.000E+00	0.000E+00	1	0	BUS-DM	33.333

BLANK CARD TERMINATING BRANCH CARDS. | BLANK CARD ENDING BRANCHES

SOURCE.	0.18E+03	0.60E+02	0.00E+00	0.00E+00	114	BUS-A0	180.0	60.0	0.0
SOURCE.	0.18E+03	0.60E+02	-0.12E+03	0.00E+00	114	BUS-B0	180.0	60.0	-120.0
SOURCE.	0.18E+03	0.60E+02	0.12E+03	0.00E+00	114	BUS-C0	180.0	60.0	+120.0
SOURCE.	-0.63E+01	0.00E+00	0.00E+00	0.00E+00	119	BUS-OM-1	-5.00		

U.M. DATA BEGINS. LIST=25 CELLS USED = 317

BEGIN U.M. INPUT = 0

FIRST OF CARD SPLIT. 4 1 1

2ND OF SPLIT.	0.00000E+00	0.20291E-01	0
3RD OF SPLIT.	0.00000E+00	0.20291E-01	0

BLANK CARD ENDING BRANCH CARDS. | BLANK CARD ENDING UN-NACH TABLE

COIL 1.	0.63000E-01	0.19110E-03	1	10.063	0.0003925	BUS-A1	1.0 0
COIL 2.	0.63000E-01	0.19250E-03	1	10.063	0.0003925	BUS-B1	1.0 0
COIL 3.	0.63000E-01	0.19250E-03	1	10.063	0.0003925	BUS-C1	1.0 0
COIL 4.	0.83000E-01	0.19250E-03	1	10.083	0.0003925	BUSRB1	1.0 0
COIL 5.	0.83000E-01	0.19250E-03	1	10.083	0.0003925	BUSRC1	1.0 0
COIL 6.	0.83000E-01	0.19250E-03	1	10.083	0.0003925	BUSRA1	1.0 0

BLANK CARD ENDING COIL TABLE. ALL UM DATA

BLANK CARD TERMINATING SOURCE CARDS. | BLANK CARD ENDING UN-COIL TABLE DATA

BLANK CARD ENDING SOURCES

should be left blank if no zero current flow is desired.

Note that no EMTP phasor solution has been requested. Although not obvious to the reader, no user-specified initial conditions (after the blank card ending sources) were present, either. Hence the entire problem began with zero initial conditions. Well, on to the solution. EMTP printout of the time-step loop begins as follows:

STEP	TIME	BUS-A1	BUS-B1	BUS-C1	BUS-A0	BUS-0M	BUS-A1 BUS-A0	BUS-B1 BUS-B0	BUS-C1 BUS-C0	TERRA BUS-0M
		UM-1 TQGEN	UM-1 OMEGM	UM-1 THETAM	UM-1 IPA	UM-1 IPB	UM-1 IPC	UM-1 IE1	UM-1 IE2	UM-1 IE3
0	0.000000	0.000000E+00	0.000000E+00	0.000000E+00	0.000000E+00	0.000000E+00	0.000000E+00	0.000000E+00	0.000000E+00	0.000000E+00
1	0.000200	0.792363E+02	0.344503E+02	0.448358E+02	0.179489E+03	0.999950E+02	0.100192E+03	0.435415E+02	0.566508E+02	0.299588E+03
2	0.000400	0.901722E+02	0.236388E+02	0.505335E+02	0.177957E+03	0.299969E+01	0.977851E+02	0.359220E+02	0.618631E+02	0.899916E+03
3	0.000600	0.805619E+02	0.245334E+02	0.560285E+02	0.175415E+03	0.499857E+01	0.948529E+02	0.282137E+02	0.666394E+02	0.149959E+02
4	0.000800	0.901722E+02	0.236388E+02	0.505335E+02	0.177957E+03	0.299969E+01	0.977851E+02	0.359220E+02	0.618631E+02	0.899916E+03
5	0.001000	0.798783E+02	0.135973E+02	0.662811E+02	0.167360E+03	0.898337E+01	0.874814E+02	0.126977E+02	0.747838E+02	0.265044E+02
6	0.001200	0.788111E+02	0.763272E+01	0.709773E+02	0.161893E+03	0.109575E+00	0.830829E+02	0.497409E+01	0.781088E+02	0.328728E+02

To complete the display, I also show the final few steps, plus printout of the extrema. Note that since the preceding memo, we have added minima, and that maxima no longer involve the absolute value:

2300	0.460000	-0.140618E+03	-0.148803E+02	0.155498E+03	-0.145823E+03	0.187614E+03	0.500515E+01	0.393479E+01	-0.893994E+01	-0.562947E+01
2400	0.480000	0.501062E+02	0.167232E+03	0.117125E+03	0.556231E+02	0.187711E+03	0.551696E+01	0.983495E+01	-0.331809E+01	-0.563139E+01
2500	0.500000	0.171599E+03	0.883842E+02	0.332147E+02	0.160000E+03	0.187693E+03	0.840112E+01	0.181580E+01	0.678332E+01	0.389335E+01

MAXIMA AND MINIMA WHICH OCCURRED DURING THE SIMULATION FOLLOW. THE ORDER AND COLUMN POSITIONING ARE THE SAME AS FOR THE REGULAR PRINTED OUTPUT VS. TIME.

VARIABLE MAXIMA :										
	0.171728E+03	0.171768E+03	0.171840E+03	0.180000E+03	0.196948E+03	0.996771E+02	0.106135E+03	0.100357E+03	0.743949E+03	0.144744E+03
TIMES OF MAXIMA :										
	0.366800E+00	0.355600E+00	0.361200E+00	0.500000E+00	0.247400E+00	0.910000E+01	0.132000E+01	0.354000E+01	0.320000E+02	0.389000E+01
VARIABLE MINIMA :										
	-0.171828E+03	-0.171805E+03	-0.171674E+03	-0.180000E+03	-0.247981E+00	-0.102957E+03	-0.998215E+02	-0.103962E+03	-0.590649E+01	-0.186582E+03
TIMES OF MINIMA :										
	0.358400E+00	0.364000E+00	0.369400E+00	0.250000E+00	0.320000E+02	0.160000E+01	0.716000E+01	0.106000E+01	0.247400E+00	0.116000E+01

Now on to the plotting, to really see what is happening. Plots are shown on the following page. We have:

Fig. 1 : Plot of "a"-phase rotor current over the full half second of simulation time. This starts off as 60 HZ ac, but after about 0.4 seconds it looks like dc (the machine is up to speed, with slip so small that the sinusoidal curvature is not obvious over the observation time of the plot).

Fig. 2 : Like Fig. 1, only just for the first 50 msec of the simulation. The 60 HZ sinusoidal character is obvious.

Fig. 3 : Plot of rotor speed (UM-1, OMEGM) over the full half second of simulation. Note the 60 HZ oscillation over the first 120 msec or so. Why does it die out when it does, Hian? What governs the amplitude of this? At about 240 msec, the rotor slightly overshoots its final speed, and thereafter there is a rapidly damped decay to the final operating point.

Fig. 4 : Plot of electromechanical torque (UM-1, TQGEN) over the full half second of simulation. This begins with a 60 HZ oscillatory component (see Fig. 5), and ends as a constant. The time range (.25, .40) is readily understood to produce a balancing torque about the steady-state operating point.

TPIM-8

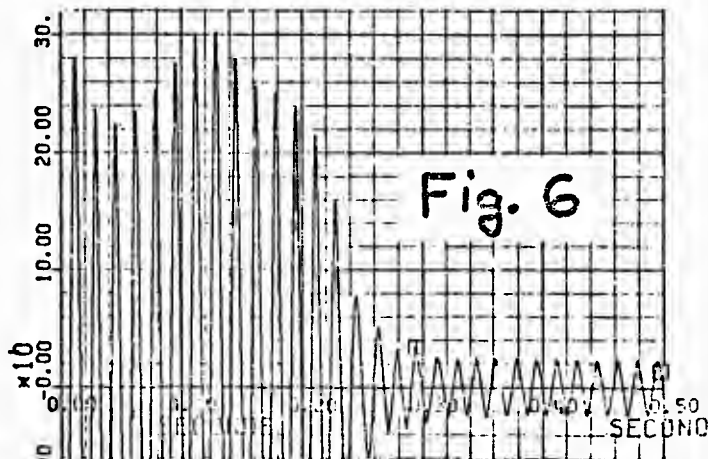
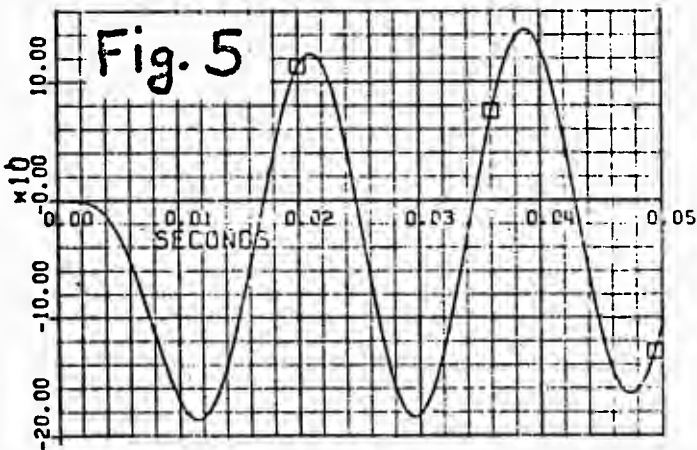
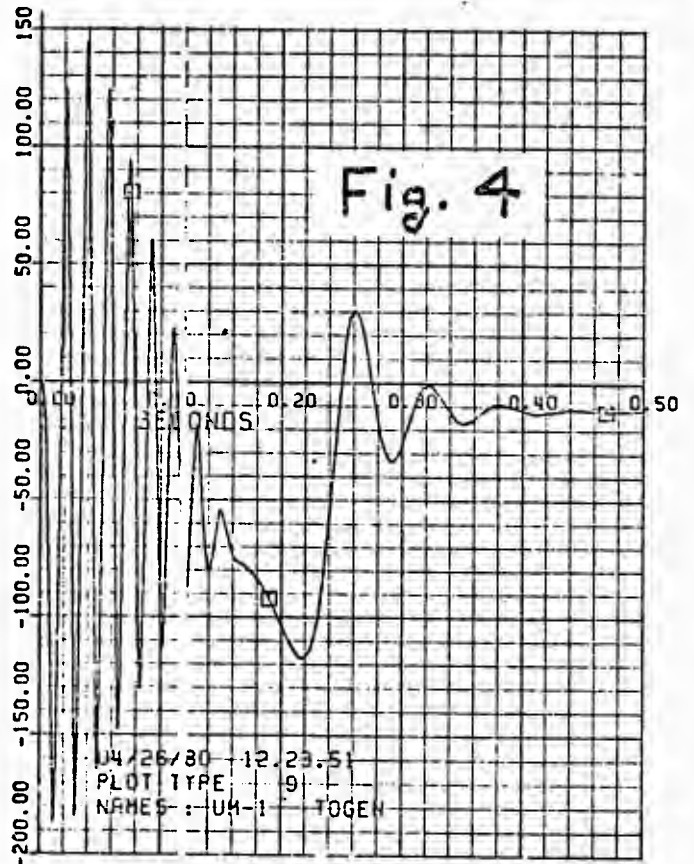
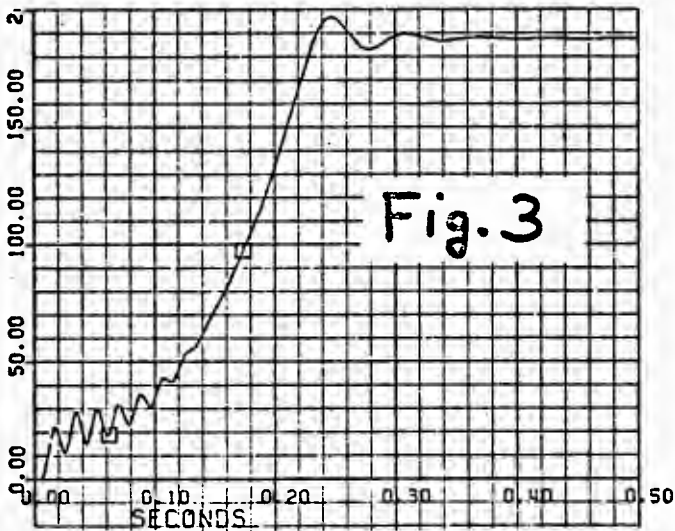
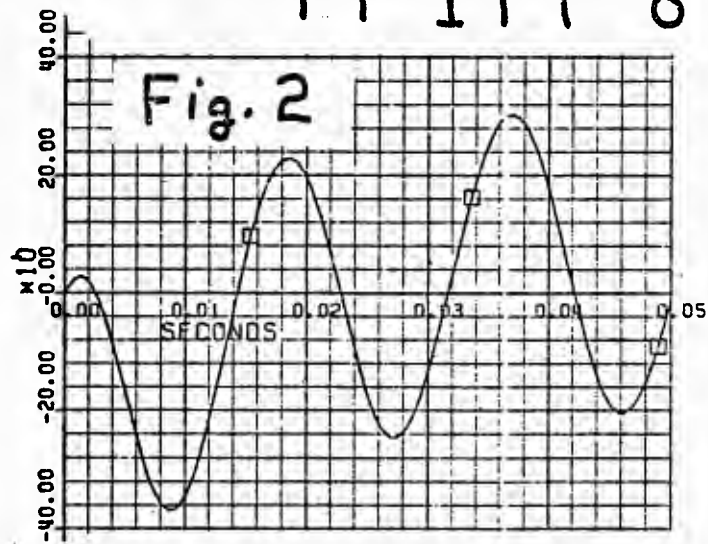
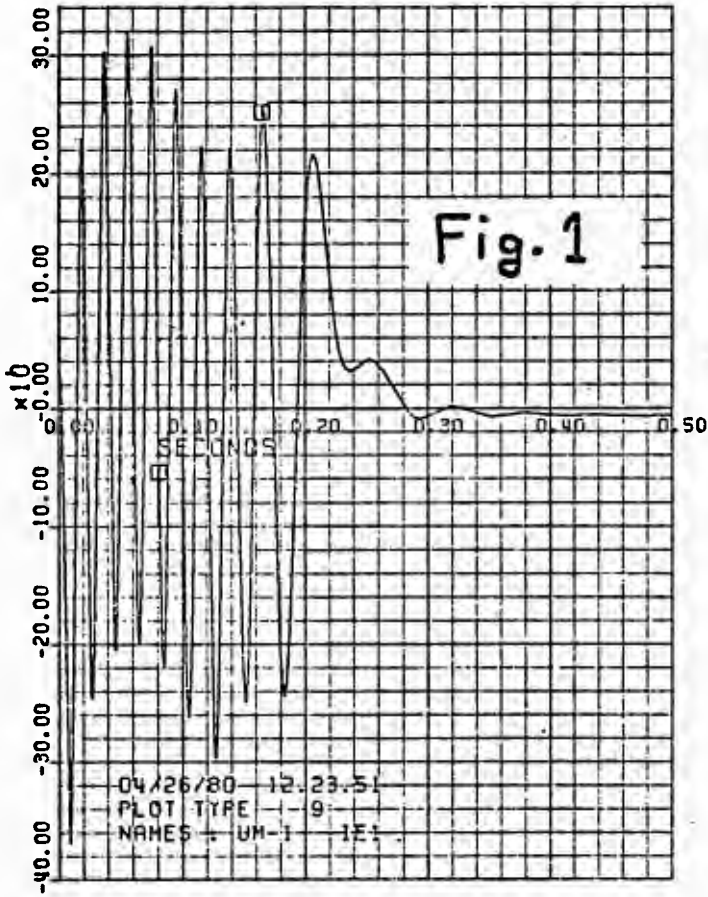

TPIM-9

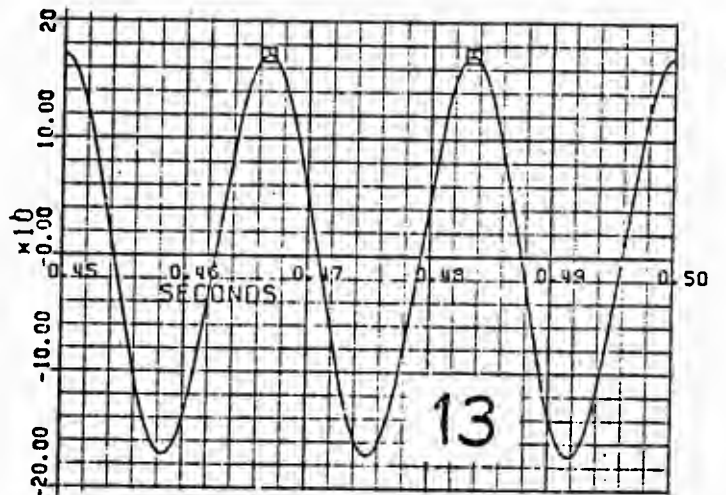
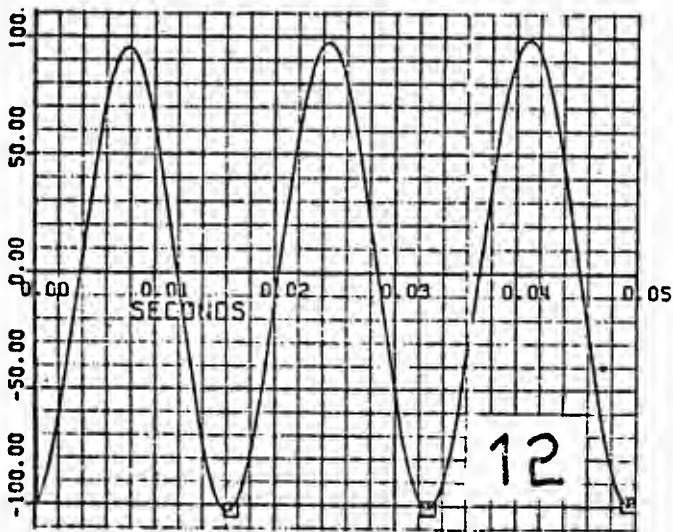
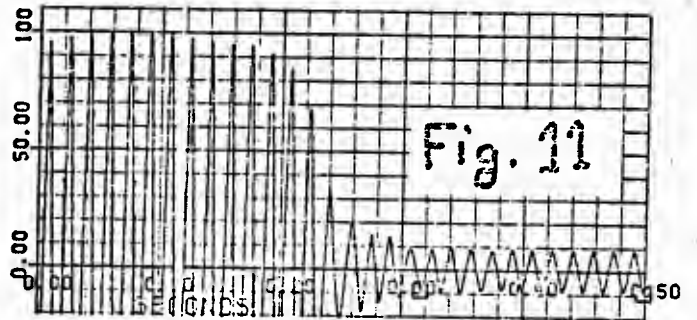
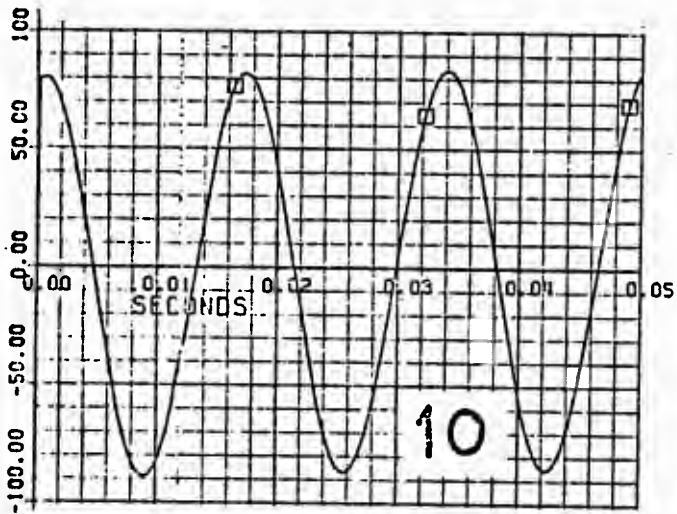
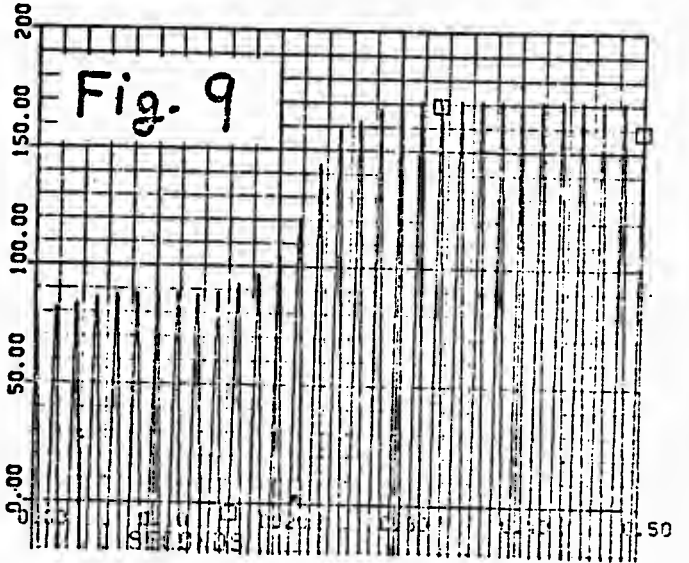
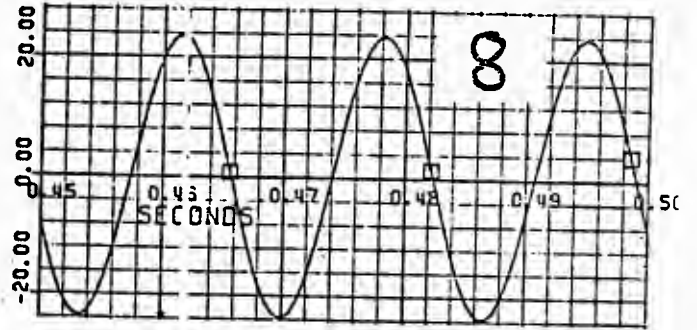
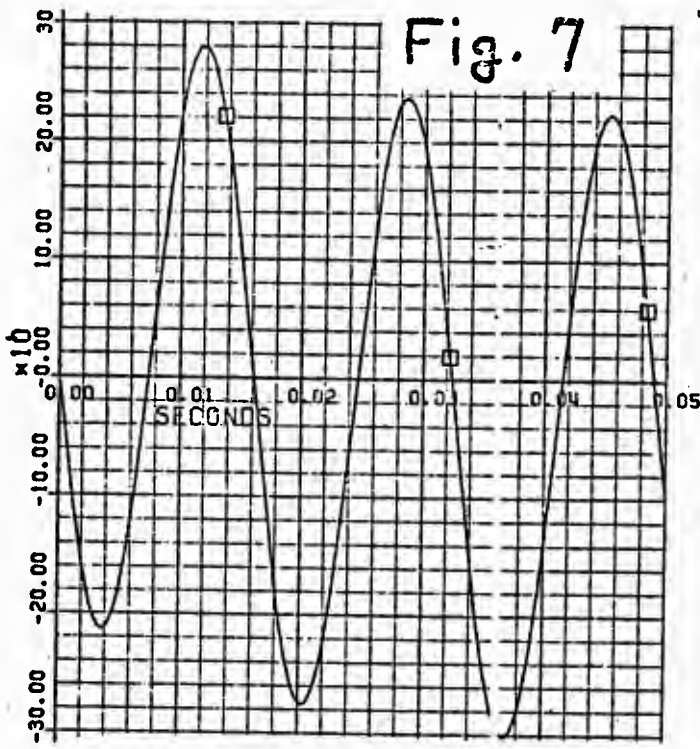

- Fig. 5 : Like Fig. 4, only just for the first 50 msec of the simulation. The 60 Hz sinusoidal character with small negative offset is obvious.
- Fig. 6 : Armature current (UM-1, IPA) over the full half second of simulation time. This is basically a 60 Hz sinusoidal signal, though strongly amplitude modulated. The initial modulation, over the first 150 msec or so, seems to have a period of about 100 msec (why, Hian?). After about 300 msec, the final steady state is reached, with armature current peaks of about 24 amps.
- Fig. 7 : Like Fig. 6, only just for the first 50 msec of the simulation. The 60 Hz sinusoidal shape is obvious.
- Fig. 8 : Like Fig. 6, only for the final 50 msec of the simulation. The symmetric, 60 Hz sinusoidal character is obvious.
- Fig. 9 : Phase "a" armature voltage "BUS-A1" over the full half second of simulation. This is basically a 60 Hz sinusoidal signal, though strongly amplitude modulated. The rapid change in the envelope occurs over the time range (180, 280) msec, for reasons which maybe Hian can explain.
- Fig. 10 : Like Fig. 9, only just for the first 50 msec of the simulation. Note the sinusoidal 60 Hz character.
- Fig. 11 : Phase "a" voltage drop across the R-L source impedance; EMTP branch voltage (BUS-A1, BUS-A0). This is amplitude-modulated 60 Hz signal. The envelope change correlates with that of Fig. 9, of course, by Kirchoff's voltage law.
- Fig. 12 : Like Fig. 11, only for the first 50 msec of the simulation. The sinusoidal nature, with slight initial offset, is obvious.
- Fig. 13 : Like Fig. 11, only for the final 50 msec of the simulation. The balanced 60 Hz sinusoidal nature is obvious.

So much for conventional plots as functions of time. Hian says that one more plot would be most valuable: torque (UM-1, TQGEN) as a function of speed (UM-1, OMEGM). Hian says that such a curve is very meaningful to designers. Could be, though I myself would not know what to do with it! The locus started on the left (zero speed), and moved to end up in a fine spiral on the right, as the oscillation about the loaded operating point died out. But what about that region from zero to 80 rad/sec, where it looks like someone trying to start a jammed ball point pen?! Note that this looks nothing like the classic single-valued steady-state curve. We will get Hian to add some words of wisdom at the end. After all, he was the one who ordered it!

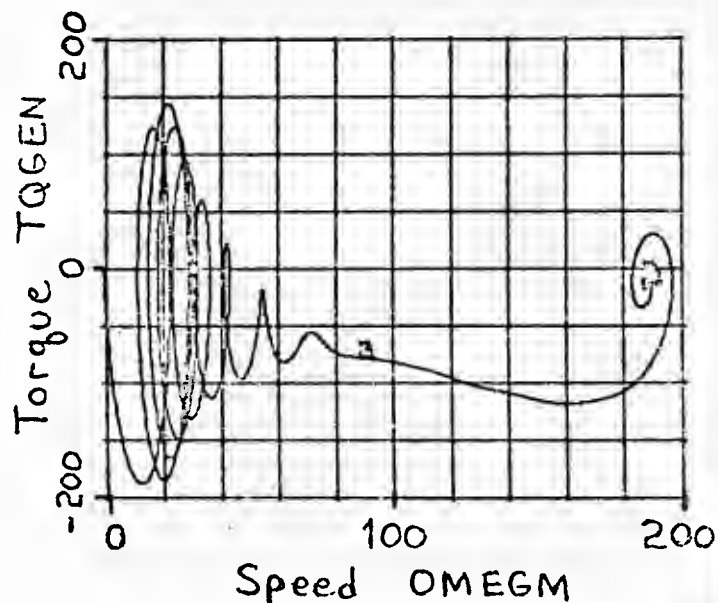

I do not have many more comments about this example. The time-step size of 0.2 msec was selected arbitrarily. It seems to be sufficiently small, since a rerun using 1000 steps of size 0.1 msec produced Versatek plots which superimpose perfectly with those just shown (plotted to the same scale, one holds them up to the light). As for larger steps, I can assure the reader that 1.0 msec is too big. Shown at the right is the speed (UM-1, OMEGM) --- not much of a likeness to Fig. 3. As for intermediate steps, 0.4 msec seems to give good results. Plots of "OMEGM", "IPA", and "TQGEN" superimpose perfectly with Figures 3, 6, and 4, respectively, over the 400 msec of the simulation. But rotor current "IE1" showed a minor difference, just around that relative minimum at time 220 msec (compare the result at the right with Fig. 1). One might be able to run with time step equal to half a millisecond, then, if one is not too particular about minor details. But this is about the limit.

So much for WSM's work on this problem. As with the preceding memo, I encourage Hian to comment on whatever aspects occur to him, in the rest of this section. Hian!

TPIM-11

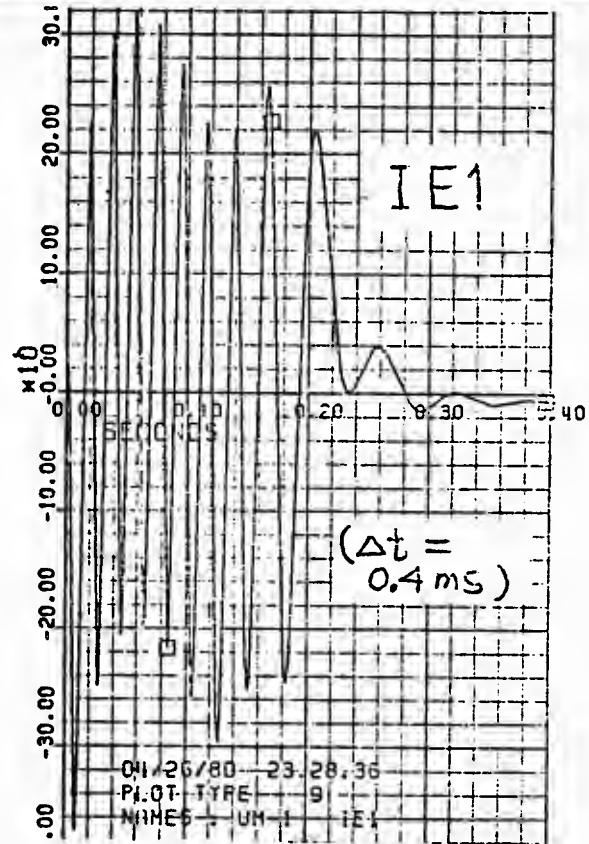
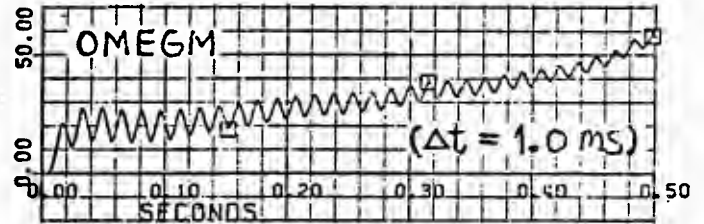

Note on Scott's Memorandum, d.d. April 15, 1980

First of all, I'd like to express my appreciation to Scott for the clear documentation of his experience with this first use of the induction machine mode of the U.M. The machine with a rating of 30 hp, 220V, four pole, 60 Hz, y-connected, was subjected to an energization test, which gives rise to one of the most severe transient conditions for an induction motor.

It is very reassuring to know that the U.M. transient torque-speed characteristics matches exactly with the results as published by NASAR and UNNEHWER in their book: "Electromechanics and Electric Machines," John Wiley and Sons, 1979, pp. 422-425. It has to be noted that the U.M. torque-speed characteristics are upside down as compared with conventional usage. This is because the sign convention of the U.M. variables are generator based, thus, if the U.M. is in motor mode, then the electromechanical torque is negative. It is also to be pointed out that the shown U.M. torque-time characteristic at Fig. 4 has much more pronounced oscillations than the one shown by NASAR and UNNEHWER, due to their zero line reactance. Scott also did run this case, which then shows an exact match. The corresponding U.M. output is given in the figure below (see next page):

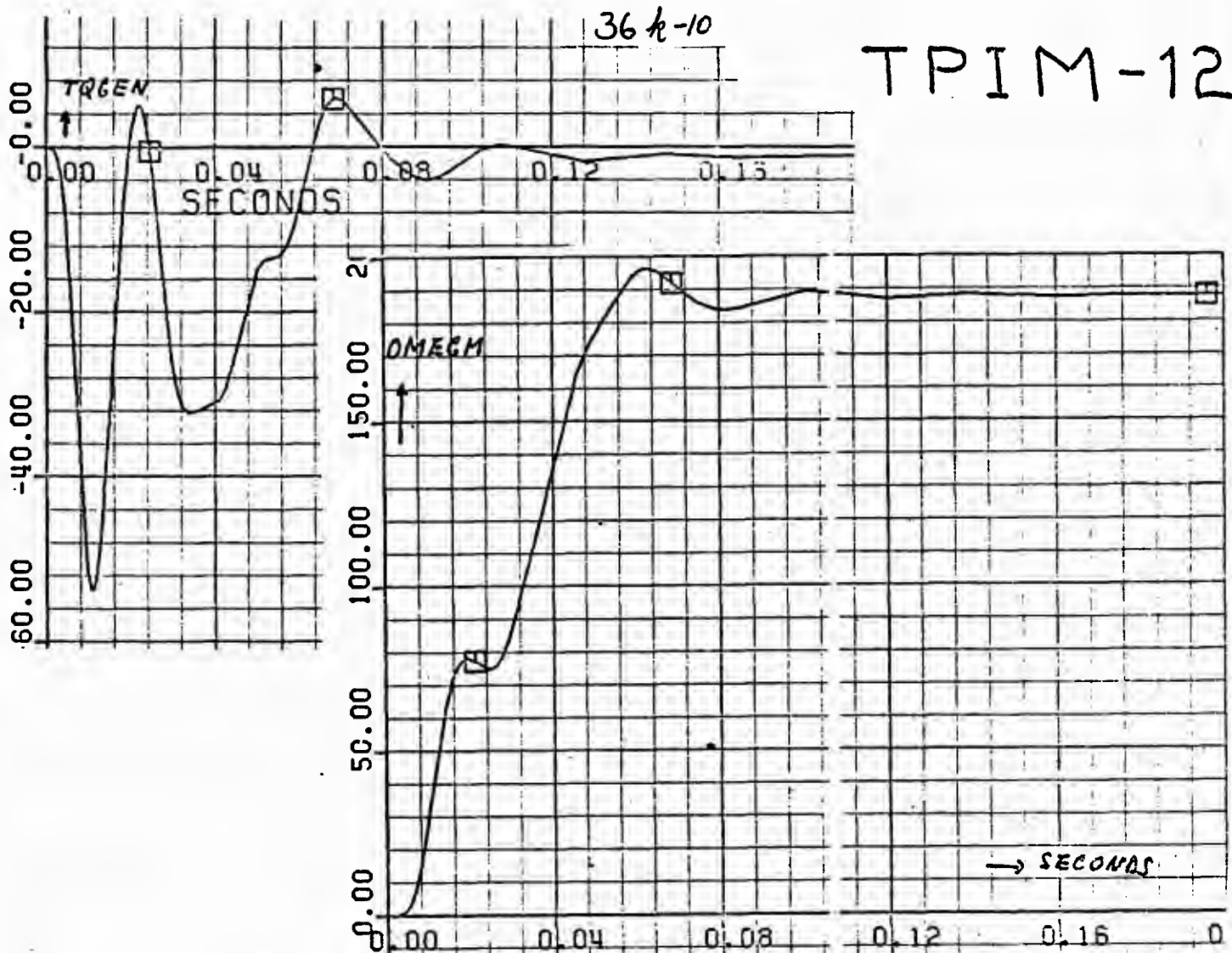

Now my comments as invited by Scott on the following items.

- (a) The reason for the rotor speed oscillation to die out after about 120 msec, as shown in Fig. 3. This is due to the fact that these oscillations are "governed" by the oscillations of the electromechanical torque TQGEN. As evidenced by the output of Fig. 4, the severe oscillations in this torque indeed subside after about 120 msec. The behavior of the electromechanical torque during energization is difficult to predict, it really forms the motivation for having an appropriate transient model to reveal the interesting transient world of induction machines. Simplified linearized analysis produces nonvalid results, particularly due to the strong nonlinear coupling of mechanical speed and electric currents during the energization process (induction motors have relatively small rotor moments of inertia). For example, it is known that the oscillatory behavior of the electromechanical torque as shown in Fig. 4 is dependent on the time interval between closing of the switches on the three lines: Another important effect to this oscillatory behavior is the machine leakage inductance, as well as the line reactances.
- (b) Modulation of armature current, as shown in Fig. 6. Scott observed a low frequency modulation with a period of about 100 msec. The observed periodicity is deceiving, Scott, due to the fact that the modulation is generated by the behavior of the product of rotor speed and main flux. A simplified linearized analysis predicts a decay of the envelopes of the armature currents, if it is assumed

36 k-11

that the rotor speed is increasing as a ramp function. However, as can be seen from Fig. 3, this assumption is not very valid during the first 100 msec. The average rate of increase of the rotor speed at a certain interval in this period is lower than in the other periods. My own experience is that the referred-to modulation can be more or less suppressed by decreasing the leakage inductance or by decreasing the line reactance.

- (c) Significance of the transient torque-speed curve. The transient torque-speed characteristics are significant in the sense of providing an understanding to the transient behavior relative to the rather well predictable steady-state torque-speed curve. The importance of this understanding is shown in numerous studies, for example: the study of oscillatory torque behavior near zero slip due to stator resistance effect, torque production during fault recovery and of course, during energization. Although not apparent from the figure on page TPIM-10, the transient torque-speed is regular. It has to be realized that if in motor operation the electromechanical torque is greater than the load torque, then the rotor speed is increasing. And vice versa, if this torque is smaller than the load torque, then the rotor speed is retarded. Hence for one oscillation, the following behavior of the transient torque-speed curve will be seen (note: for motor operation the electromechanical torque = - TQGEN because of the U.M. generator convention):

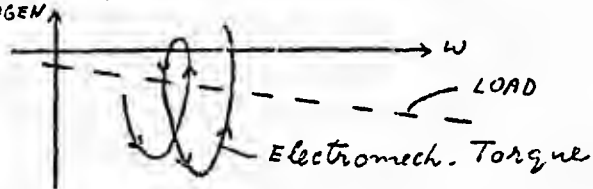

1.63 I ILLUSTRATIVE U.M. APPLICATION AS 3-PHASE SYNCHRONOUS MACHINE

To show the user the structure of a data case that involves U.M. modeling, I present Hian's synchronous machine problem. EMT data is documented by the output of the following page, which corresponds to the electric circuit shown here:

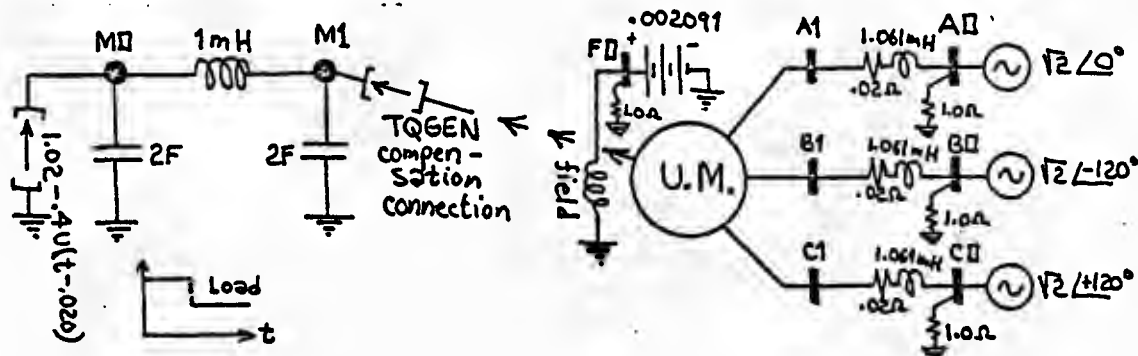

In the semi-random order that observations about this data occur to me, I offer the following:

- Point 1 : The first four branches go from the four voltage sources to ground. They have no functional usage other than ensuring connectivity to ground, I guess. They do not affect the mathematical solution, note.
- Point 2 : The field winding is connected to the electric network through bus "BUS-F0". This is a compensation connection, even though all Hian wanted was a dc voltage. Why? Later, when the TACS connection is debugged, a dc source from TACS can be connected for this purpose, and the compensation (and electric network connection) can be spared.
- Point 3 : We are here using the new (since "M21,") feature that allows the user to punch "BLANK" in columns 1-6, and have the resultant data card appear as a blank card to the EMT. Thus one can name the blank cards, which is sometimes less confusing. "CIMAGE" blanks out such special records.
- Point 4 : The second data card serves to divide the total working space of List 25 (3700 cells) among the four different U.M. tables. The key word is "ABSOLUTE U.M. DIMENSIONS", named by analogy to the corresponding card for TACS ("ABSOLUTE TACS DIMENSIONS"; see Vol. VIII, 27 January 1979, page PROV-19. This card requests a limit of 20 cells (for all components of the U.M. tables), a limit of 2 machines, etc. This is absolute allocation: a specific number. The card is now mandatory. Later, we shall make it optional (as with TACS), and we shall also provide a "RELATIVE U.M. DIMENSIONS" option, just as with TACS. The interpretation shows that we are using only 317 of the 3700 cells which are available.

This is most encouraging (317 cells for a 3-phase synchronous machine is nothing) though not quite the full story. Remember that the mass-spring system shows up as a ladder network on the electrical side (so is not counted here), and there also is constant added overhead for working arrays of fixed dimensions (e.g., 3x3 arrays). This latter item will show up in increased virtual address space on our map (it is effectively counted with the increased code size) which shall be considered later.

Point 5 : The third data card is a comment card (before being disabled, we had a "DIAGNOSTIC" card). This is a change from "M21." versions: a space is required in column 2, after the "C".

Point 6 : The infinite bus is "BUS-A0", etc. Note that it is of frequency 60 Hz, and amplitude $\text{SQRT}(2.0)$. Clearly, Hian is operating in per unit, then. This had better not be a requirement, however. I will check this point with Hian (I confess never to have raised the subject before, which is somewhat of an oversight).

Point 7 : The values for the masses and the springs (capacitors and inductors) are quite arbitrary; they bear little relation to any known reality. This aspect (realistic shaft system modeling) is to be considered when correlation with the existing EMTF S.M. modeling for the Allis Chalmers or IEEE SSR Benchmark test cases is attempted. Later, Hian chose masses (capacitors) of 2.0 Farad, and I simply adjusted the spring (inductor) to $1.E-3$ Henry so as to produce a reasonable resonant frequency of several Hertz.

Point 8 : The U.M. data is an EMTF source by classification, of type code 19. As presently set up, all U.M. components must be in order (contiguous data cards), following the single Type-19 request card. Nothing else is required on the request card, which simply transfers control to Hian's input routine "UMDATA" of overlay 5, where all U.M. data input actually occurs. Note that the U.M. data is by classes: first three data cards associated with the U.M. machine table (the machine as a whole). My feeble interpretations like "FIRST OF CARD SPLIT", "2ND OF SPLIT", etc., merely reflect ignorance as to what the data actually is. The "split" comes from the fact that Hian originally read all of this data with a single READ, which I converted to three CALL CIMAGE and DECODE usages. Next come the coil cards, one for each coil of the machine. This is conceptually a little more obvious. Here Hian must input parameters of the coil (e.g., resistance), and its connection to the electric network and/or TACS. It looks to me like Hian has only three rotor coils (3 armature coils are required by the 3-phase machine, and $6-3=3$), though an arbitrary number are permitted. The six coil cards are terminated by a blank card, ending the U.M. data (for this one-machine case). But why is there not a blank card ending U.M. components, after the blank card ending coils? I will have to check this (maybe we can not now use over one!).

Point 9 : Next come initial conditions for all electric network nodes and branches. This is a major inconvenience occasioned by lack of a steady-state connection. Yet I do not believe that

this is a requirement. For Hian, this worked well; he set it up once, and then used it over and over. Very clean, for this usage. But a real burden for the production user. We should be able to use the phasor solution capability of the program automatically. Just as Herb and Al used to dump trapped charge on a transmission line by using 60-Hz sinusoidal sources that would be disconnected on the first time step, so three extra Type-14 sinusoidal sources and connected switches should do the job for the U.M. Note that this does not automatically initialize the U.M. itself (the original problem), but at least it does handle the electric network. On the page 4 listing, note that not all initial condition cards are shown (the listing is cut after the second branch condition). This is not considered to be an important detail.

Point 10: The nature of the transient is seen by inspection of the Type-11 current source connected to node "BUS-M0". Hian is using the electrical analog for the mechanical system wherein current is torque, and this particular source is the mechanical load, connected to mass number zero. There are two sources in parallel, with the first (value 1.02) representing the steady-state mechanical load. The second one (value -.4) only begins at time TSTART = 20 msec; this is the transient, a 40% load reduction after just over one cycle of steady-state operation.

So much for documentation and explanation of the input data. On to the solution to this transient problem! Consider the time-step loop variable headings and initial printout:

STEP	TIME	SUS-A1	BUS-B1	BUS-C1	BUS-M1	BUS-M0	BUS-A1 BUS-A0	BUS-B1 BUS-B0	BUS-C1 BUS-C0	BUS-M1 TERRA
		BUS-M0 TERRA	BUS-M0 BUS-M1	UM-1 TOGEN	UM-1 OMEGM	UM-1 THETAE	UM-1 IRA	UM-1 IRB	UM-1 IRC	UM-1 ISI
		UM-1 IS2	UM-1 IS3							
0	0.000000	0.156413E+01-0.307450E+00-0.125677E+01	0.100000E+01	0.100000E+01	0.100000E+01	0.100000E+01	0.138494E+01-0.957930E+00-0.427010E+00	0.000000E+00	0.000000E+00	0.000000E+00
		0.000000E+00 0.101000E+01 0.100124E+01	0.100000E+01	0.100000E+01	0.937870E+00	0.138600E+01-0.958770E+00-0.427210E+00-0.282600E+01				
1	0.001000	0.125371E+01 0.317285E+00-0.157094E+01	0.100000E+01	0.100000E+01	0.100000E+01	0.140050E+01-0.508886E+00-0.891630E+00	0.120946E-01	0.100003E-01	0.101000E+01 0.997905E+00	0.100000E+01 0.937870E+00
		0.100003E-01 0.101000E+01 0.997905E+00	0.100000E+01	0.100000E+01	0.937870E+00	0.140050E+01-0.508886E+00-0.891630E+00-0.282595E+01				
2	0.002000	0.862512E-04-0.481940E-02	0.763604E+00 0.891566E+00-0.165513E+01	0.100001E+01	0.100001E+01	0.122098E+01 0.106571E-01-0.123161E+01	0.153366E-01	0.100017E-01	0.101000E+01 0.994662E+00	0.100001E+01 0.937872E+00
		0.100017E-01 0.101000E+01 0.994662E+00	0.100001E+01	0.100001E+01	0.937872E+00	0.122098E+01 0.106571E-01-0.123161E+01-0.282582E+01				
		0.308536E-03-0.925470E-02								

Point 11: U.M. output quantities are identified by a pair of A6 names that are internally generated, much as is the case with the production S.M. code. The first name is always "UM-1" (for the first machine; if there were a 2nd, it would be "UM-2"), while the second identifies the variable in question. Some of these are a little less than obvious, due to requirements of the universal approach. I list all of them in any case:

TOGEN --- electromechanical torque (obvious).

OMEGM --- angular speed ("omega") of the generator, clearly in per unit (note value of unity).

THETAE -- Torque angle ("delta") of the machine, in radians.

IRA ---- Current in the armature winding of phase "a", apparently in per unit here (since the whole electric network is). The "R" is for rotor, documentation of the inverted nature of Hian's U.M. equations. I myself first learned this two days ago! Well, no problem. This is

just like in the classic generalized-machine text by White and Woodson (the MIT formulation was inside out as well, if I still remember my studies during 1965). So, although we continue to talk about the field of a synchronous machine being on the rotor, the user must remember that the U.M. model puts it on the stator (coil "IS1").

SRFH-7

IS1 ---- Current in the first stator winding. This is the field circuit, connected to electric network node "BUS-F0", for this synchronous machine problem. Currents "IS2" and "IS3" are in the two remaining stator coils, which are damper windings ("kd" and "kq" in terms of our established S.M. notation, I guess).

Point 12: The machine is clearly coming out of the steady-state very smoothly. The speed and torque look fine. Step 2 shows the beginning of a little wobble: OMEGM = 1.00001. This grows to 1.00015 by the time we are ready to switch at 20 msec. This has no physical significance, and is in no way to be taken as a possible sign of instability (Hian has run the U.M. in the steady-state for two seconds without any hint of trouble). My own feeling is that the large time-step size of 1.0 msec is explanation enough (since the discretization implies some error).

Well, the simulation was run 1000 time steps, out to the end time of one second. The final two output lines, plus the extrema, follow:

```
900 0.900000 0.166883E+01-0.608536E+00-0.984038E+00 0.996428E+00 0.998790E+00 0.558224E+00-0.751653E+00 0.193449E+00 0.116958E+00
0.101907E+00 0.518093E+00 0.401135E+00 0.996428E+00 0.455968E+00 0.558224E+00-0.751653E+00 0.193449E+00-0.229072E+01
0.595775E-01-0.860758E-01
1000 0.100E+01 0.167027E+01-0.566366E+00-0.101915E+01 0.100353E+01 0.100209E+01 0.668746E+00-0.790526E+00 0.121800E+00 0.257324E-01
0.113804E+00 0.506196E+00 0.480463E+00 0.100353E+01 0.473066E+00 0.668746E+00-0.790526E+00 0.121800E+00-0.229490E+01
0.763218E-02 0.542830E-01
```

PEAK OUTPUT VARIABLE VALUES WHICH OCCURRED DURING THE SIMULATION FOLLOW. A MINUS SIGN MEANS THAT THE PEAK ABSOLUTE VALUE OCCURRED WITH NEGATIVE POLARITY. THE ORDER AND COLUMN POSITIONING ARE THE SAME AS FOR THE REGULAR PRINTED OUTPUT VS. TIME (SEE PRINTED HEADINGS ABOVE).

```
0.170030E+01-0.169691E+01 0.169354E+01 0.100779E+01 0.100866E+01 0.141878E+01-0.141540E+01-0.141330E+01-0.292633E+00
-0.389231E+00 0.101000E+01 0.100348E+01 0.100779E+01 0.940109E+00 0.141878E+01-0.141540E+01-0.141330E+01-0.282600E+01
0.133338E+00-0.185827E+00
INSTANTS OF TIME AT WHICH THE JUST-PRINTED EXTREMA OCCURRED.
0.716000E+00 0.663000E+00 0.744000E+00 0.443000E+00 0.512000E+00 0.340000E-01 0.310000E-01 0.200000E-01 0.100000E+00
0.200000E-01 0.000000E+00 0.480000E-01 0.443000E+00 0.460000E-01 0.340000E-01 0.310000E-01 0.200000E-01 0.000000E+00
0.178000E+00 0.189000E+00
```

On to plotting. Each time instant was saved (I PLOT=1), and the batch-mode solution involved three printer plots of one variable each (spring torque, field current, torque angle), with 6-inch time axis. These shall not be shown. Instead, the next page is filled with high resolution plots which were made after the fact, using the "COPY" feature (for connection to our Versatek printer/plotter) of interactive plotting (see Vol. IX, 11 May 1979, page PIEP-22). Several comments might be offered about these results:

Point 13: Fig. 1 shows the inductor current, or spring torque, which provides an indication of the relative position of the two rotor masses. Two masses means two eigenvalues (natural frequencies), which are clearly apparent. A quick eyeball inspection shows periods of about 0.6 sec and .14 sec. This can be easily verified theoretically, since poles of the L-C electric network satisfy the Laplace-domain equation $S^2 + 1000 = 0$. The roots are the radian

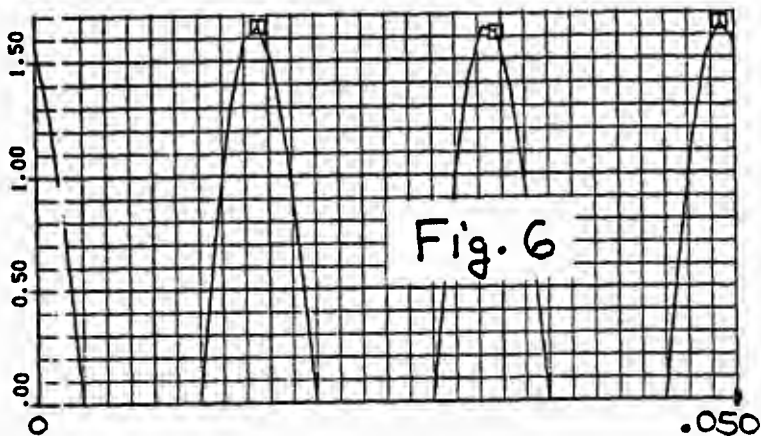
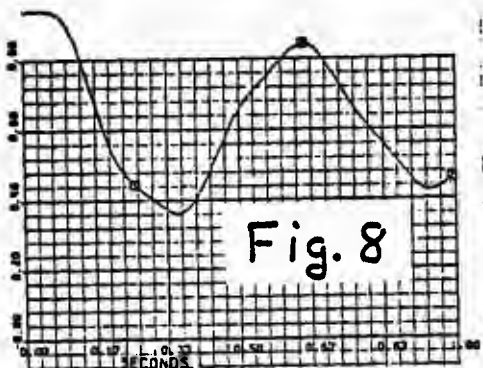
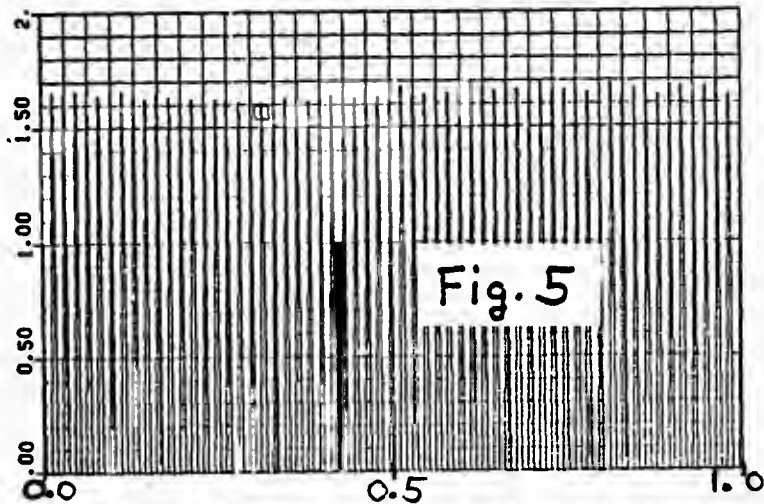
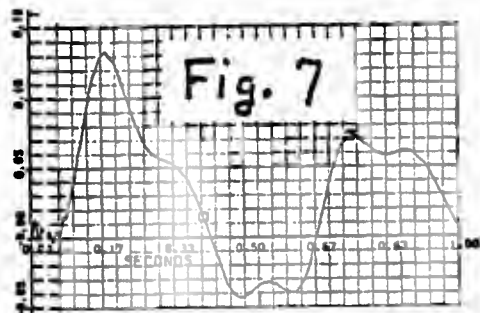
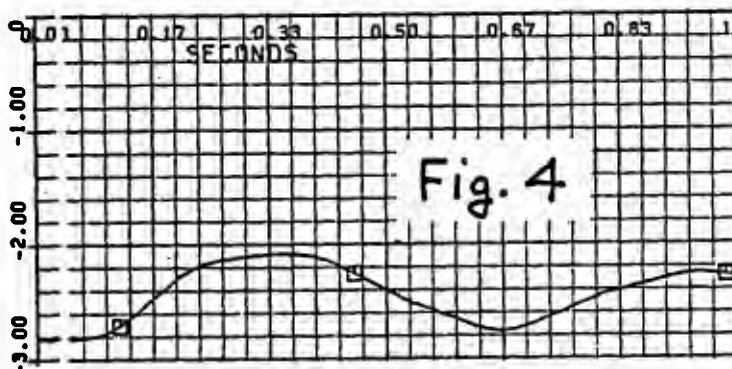
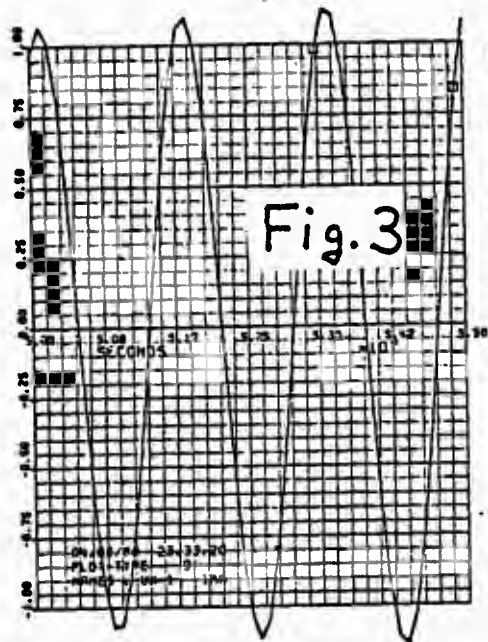
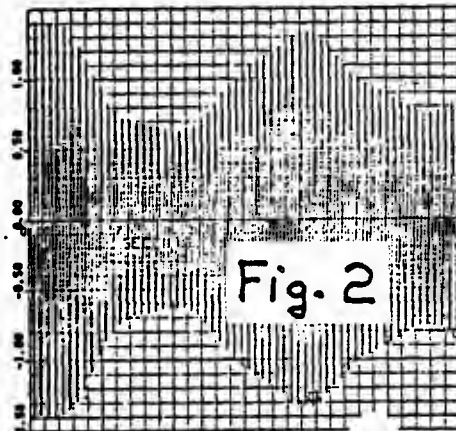
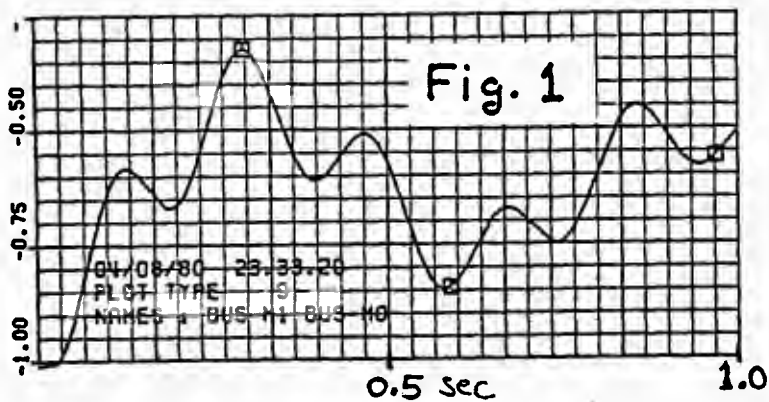

frequency $\omega = \text{SQRT}(1000)$, which implies $f = 5.033 \text{ Hz}$, and finally a period $T = .1987 \text{ sec}$. Is this close enough to be believable? Why the discrepancy? What happened to the second mode, the transient stability mode? I will give Hian an opportunity to interpret this, and provide answers to other questions which I have raised, at the end of the memo.

SRFH-9

- Point 14: Fig. 2 shows the armature current in phase "a" (UM-1, IRA), over the full simulation interval (0.0, 1.0). The vertical spikes are sixty in number, and in fact sinusoidal. The envelope is being modulated by that slow mode of Point 13 (the transient stability mode, the mode of both U.M. masses swinging together against the infinite bus). That this is indeed sinusoidal (except for the modulation) is seen in Fig. 3, where the time span is (.500, .550), as the envelope is increasing. The discretization due to the 1.0 msec time step is very obvious in such a plot.
- Point 15: The field current is shown in Fig. 4; as Hian predicted, the slow mode (transient stability mode) of $T = 0.6$ seconds is conspicuous here. After the transient dies out, the field current should settle at a reduced value, which is reasonable for a case of load reduction. This is sort of a 2nd order (orthogonal) effect, however, much less pronounced than the adjustment of relative mass positions in Fig. 1.
- Point 16: Terminal voltage is shown in Fig. 5. Because of the infinite bus and low-impedance connecting line, it can not change much; and it does not. As with the current in Fig. 3, an expanded display of the first 50 msec shows the expected discretized sine wave (see Fig. 6).
- Point 17: Fig. 7 shows current in the direct-axis damper coil (UM-1, IS2). While the transient stability mode dominates, the inter-mass ringing is also clearly present.
- Point 18: Finally, in Fig. 8, we have the torque angle (UM-1, THETA E). As expected, the oscillation corresponds to the transient stability mode (indeed, it is almost the definition of it). But is there some weak inter-mass ringing in there too? Oh where is that spectral analyzer which everyone talks about!

III

DIRECTION OF FUTURE U.M. WORK; HIAN'S COMMENTS

Well, that is about all the explanation that I intend to offer. Possibly there might be another example at some time in the future, but no promises are being made. By now readers should have a reasonable idea of what is involved, which is all I intended to convey.

So, Hian continues with the testing, with the 3-phase induction machine now of top priority. We are now negotiating with Ned and his industrial client in Minneapolis, to see if they could be interested in volunteering as guinea pigs. They have a production problem involving a 3-phase induction motor, about which they already know quite a bit. The EMTP would be used to improve the modeling (e.g., Ned's suggestion to put frequency dependence into the rotor circuit). But Ned is very busy, and the logistics of communicating EMTP competence to the client are a problem. We at BPA can not so get involved, though I do want such a production user to rapidly stress Hian's code! We'll see.

Hian will be writing user instructions, and these shall form Section 1.63 of the new EMTP Reference Manual (the old User's Manual) that is now being worked on. With luck, the advance copies for Madison should have this material as an integral part.

Oh, I forgot something: running time! The case summary statistics for the solution of Section II show 29.500 for CP SEC spent in the time-step loop. Not bad at all, for 1000 steps! To get a feel for how much of this we can blame on Hian, I took a similar problem involving Vladimir's Type-59 machine. The machine itself came from minicomputer benchmark DC-26 without alteration. This only has a single mass, so is slightly more simple than Hian's. As for the network, I used series uncoupled inductors of 150 ohms to tie the machine to an infinite bus of $V_a = 11.2$ THETA = -35 degrees. There was no transient, just a smooth continuation of 1000 steps out to 200 msec. The printout and plotting intervals were the same as Hian's problem, too. The operating point should have been reasonable, for it was close to Vladimir's ("M21," printout of initial condition torque was .3823E-6, while I got .3542E-6 for the doctored problem). So, Vladimir has a slightly simpler network, no transient, and smaller time step (.2 msec vs. 1.0 msec). What was his solution time? 11.600 sec in the time-step loop. Although this is all extremely incomplete and premature, Hian nevertheless comes off with flying colors on the first comparison. Based on Vladimir's previous rule of thumb that his code is two or three times as fast as the Type-50 (SCE) model, it looks like Hian's computational efficiency for this problem is comparable to that for the Type-50 (SCE) code. Amazing!

So much for WSM's commentary. I want to give Hian a chance to pass along whatever occurs to him. The rest of the section is his:

The purpose of this note is to clarify the questions as posed in Scott's memorandum. No attempt will be made to present a complete documentation of the U.M. Rather I would like to lean on Scott's excellent account of the current U.M. facilities and supply the following points which I hope will complement this first information flow of the U.M.

(a) The machine types which can be represented are:

- Type 1: Synchr. Mach., 3-phase power side
- Type 2: Synchr. Mach., 2-phase power side
- Type 3: Ind. Mach., 3-phase power side
- Type 4: Ind. Mach., 3-phase power side, 3-phase excitation side
- Type 5: Ind. Mach., 2-phase power side
- Type 6: Single-phase A.C. machines, induction or synchronous, 1-phase excitation
- Type 7: Same as type 6, except for 2-phase excitation
- Type 8: D.C. Machine, separately excited
- Type 9: D.C. Machine, series compound (long shunt) field
- Type 10: D.C. Machine, series field
- Type 11: D.C. Machine, parallel compound (short shunt) field
- Type 12: D.C. Machine, parallel field

(b) Ad point 13 of Scott's memo:

Scott observed two modes in his test-run of subjecting a 2-mass synchronous generator to a step-change of the external mechanical torque. The first mode observed is correctly attributed to the pure mechanical energy swings. The questioned second mode is to be explained as stemming from the electromechanical energy interaction, which is proportional to the ratio of the synchronizing torque and the generator rotor moment of inertia. This is usually in the order of 1 sec. Scott's approximated verification of the first mode is quite close, considering the fact that the system has 14 eigenvalues.

1.63J Rules to Change Existing S.M. Data for Solution Using the U.M.

If the user has existing Type-50, Type-52, or Type-59 S.M. data cards (Section 1.60, 1.61, 1.62), these can be converted easily so as to be solved by the more-flexible, more-general, variably-dimensioned U.M. code. Rules and suggestions for such a conversion are presented in the remainder of this present section.

In referring to S.M. data rules, "M32." or earlier program versions are assumed. This would correspond to EMTF Rule Books printed on or before April of 1982 (associated with the "M31." vintage). Only recent changes to the machine output-variable specification card are at issue. While "M33." and later program versions have S.M. rules which are incompatible with earlier program data (see Ref. 22, Vol. 3, No. 2, pages 22-27), the "M33." and later versions of U.M. modeling continue to accept the old S.M. data. To avoid ambiguity, the old format for S.M. output requests is repeated below (note that it differs from what is written in Section 1.61, Class 5, page 34g).

So, to convert Type-50, Type-52, or Type-59 S.M. data of vintage "M32." or older to a form acceptable by the U.M., change the following:

Change 1 : Add the Class-1 U.M. data cards ahead of the original
 ----- Class-1 S.M. data cards. Three new data cards are
 involved. They are to have the following content:

1st card: Punch "19" (integer nineteen) in columns 1 and 2.

2nd card: col. 1 --- Leave blank if all machines of the problem
 are represented with converted S.M. data.
 But if one or more machines is specified
 using regular, raw U.M. data, then punch
 column one with the regular U.M. meaning
 of INPU (see Section 1.63Gk).

cols. 3-8 --- Alphanumeric "SMDATA" (special request word)

cols. 9-14 -- Punch desired value of LIMASS, the assumed
 limit on S.M. rotor masses (I6 format).
 This affects only Class-5 and Class-6
 output-variable specification, since the
 U.M. itself has no such limit. If left blank,
 a default value of 10 is used.

col. 15 0 or blank -- compensation is used for
 interfacing UM with external
 electrical network.

1 -- A new option since "M33." version:
 prediction instead of compensation is
 used for the interface between UM and
 network (see Sect. 1.63K for details).

3rd card: Leave blank (or "BLANK ..." for most computers).

Change 2 : Blank out the S.M. data fields SMOUTP and SMOUTQ
 ----- (columns 11-30 of the first of Class-3 S.M. data cards).

Change 3 : Rotor masses must now be identified with 6-character names. Class-4 S.M. data cards, one per rotor mass, are to be modified by the addition of an A6-format name to cols. 71-76. Such names can then be used for node-voltage output, to give angular speed (mechanical speed is represented by electric network node voltage — the analog used). If passed to TACS and integrated, mass angles are obtained.

Change 4 : The S.M. output-variable specification card or cards must be modified substantially. Either the single-card or the double-card (extended) format will be honored, but with the following modified meaning (change from original S.M. usage):

1	2	3	4	5	6	7	8	9	10	11	12	13 ...	13+LIMASS ...	13+2*LIMASS ...
JPAR	JMIC	JIDQD	JFI	JD2	JQ1	JQ2	JFV	JETM	JETE	JIABC	JSAT	Angles θ_i $1 < i < LIMASS$	Speeds ω_i $1 < i < LIMASS$	Torques T_i $1 < i < LIMASS-1$
I1	I1	I1	I1	I1	I1	I1	I1	I1	I1	I1	I1	all I1	all I1	all I1

TEXT	JPAR	JMIC	JIDQD	JFI	JD2	JQ1	JQ2	JFV	JETM	JETE	JIABC	JSAT
A6	I5	I5	I5	I5	I5	I5	I5	I5	I5	I5	I5	I5

..... LIMASS 2*LIMASS 3*LIMASS-1
Angles θ_i $1 < i < LIMASS$	Speeds ω_i $1 < i < LIMASS$	Shaft torques T_i $1 < i < LIMASS-1$
all I1 format	all I1 format	all I1 format

JPAR — Ignore columns 1-2. There is no separate, special U.M. printout of machine parameters and initial conditions following the steady-state phasor solution. If initial conditions are desired, look at step-zero output of the time-step loop after being sure that all variables of interest have been chosen for output. Any column-1 or column-2 punches are ignored for U.M. solution.

JIDQD — Use of this column-3 punch to output armature (stator) currents in Park's coordinates will prevent simultaneous request for such output in phase coordinates (by means of a column-11 punch for JIABC).

JFV — Ignore column 8. Output of the field voltage is possible only via TACS. If the field is connected to an exciter that is represented using TACS, then the user knows which TACS variable is the field voltage, and request it for output purposes as part of TACS output-variable requests.

If the machine has no exciter, then the user must pass the field voltage into TACS using a "73NAMEFV" card as part of the Class-6 S.M. data. Here "NAMEFV" is any 6-character TACS variable name (to be used in the TACS output request, too, then).

JETM ---- This column 9 request is to print the electromagnetic
(9) torque "TQGEN".

JETE ---- Input a value of "1" to request the exciter-torque
(10) printout.

The Column-10 punch is converted from exciter-torque specification to a request for output of generator torque angle in electrical degrees if a "3" is inputted. This angle is equal to the relative generator mass angle times the number of pole pairs. The output name used is "THETAM". This torque angle is a relative angle with respect to the synchronously rotating reference frame; for no-load, it has a value of +90 degrees (as with the S.M. code).

JIABC ---- This column-11 request to print armature (stator) currents
(11) in phase coordinates (Ia, Ib, Ic) is ignored if armature currents in Park's coordinates (Id, Iq, Io) have already been requested by nonzero column-3 punch of JIDQO. But if such output appears, it will be identified using an extra "P" to signify the power side of the machine. For example, assuming machine number 7:

UM-7	UM-7	UM-7
IPA	IPB	IPC

JSAT ---- This column-12 punch still controls saturation printout,
(12) but using direct- and quadrature-axis components rather than the original S.M. use of magnitude and angle. Further it is honored only if the column-9 specification for JETM has been left blank (or zero). Again using machine number 7 as an example, variable identification will be as follows:

UM-7	UM-7
FLUXMD	FLUXMQ

THETAI ---- The former requests just for machine angles have been
(13,..) converted into requests for angular speed, or intermass torque, or both. The corresponding original punches to
or
(1,...) the right of these, for the separate output of such variables, will be ignored by the U.M. Now it is the numerical value punched which provides all selection. The punch in column "I" or "12+I" for mass "I" indicates:

"0" ---- no such output. Leaving blank is the same.
 "1" ---- mass-I angular speed, in absolute radians/sec
 "2" ---- shaft torque (I, I+1), in Newton-meters
 "3" ---- combination of "1" and "2" (i.e., both).

It is not possible to directly output the angle of the mass, note. If angle is desired, the user must first pass angular velocity into TACS, integrate this, and then output the result. Since the user named the masses (Change 3 above), this is trivial: use a Type-90 TACS source with this same A6 name (since node voltage is the electrical analog of mechanical speed). Alternatively, the Class-6 U.M. interface capability below (Change 5).

Note that U.M. speeds are in absolute radians/second, rather than relative radians/second as with the S.M.

Should the number of masses exceed 68 (single-card format) or 80 (double-card format), then a continuation card can be used. Such a card always begins in column one, whether single-card or double-card format is being used.

Change 5 : The interface with TACS, the Class-6 variables of S.M. usage, can be honored without modification. However, two extensions or generalizations are possible. Either exciter dynamics, or more than 23 masses, require such changes.

For an exciter, variable JETE of Change 4 (column 10) no longer provides such dynamics automatically, and the user must do it himself using TACS. The user must himself define TACS modeling which will determine the value of the exciter torque at each time step. The sign convention is such that this should be positive for steady-state generator operation of the exciter. The interface of this torque with the appropriate mass is done automatically by the U.M. provided the user construct an extra, new Class-6 S.M. data card (call this Rule 4a):

KK --- Punch "80" in columns 1-2, as a special
(1-2) request for this new exciter connection.

BUS --- The 6-character name of the TACS variable
(3-8) which gives the exciter torque just described.

For more than 23 masses, the original S.M. interface of angles, velocities, and torques (Rule 3 of S.M. Class 6) breaks down. In such cases, leave columns 1-2 (variable KK) blank, and punch the integer in columns 9-14 using I6 format instead. For all other interfaces (KK=71, 72, 73, 74, or 80), add three times LIMASS (see Change 1, card 2, cols. 9-14) to the original integer value.

Change 6 : Several output variable identification names have been altered, so any batch-mode plot cards, or any "POSTPROCESS PLOT FILE" usage, must be modified accordingly.

a) All machine identification has changed. Rather than the original "MACH 7" to identify the 7th S.M., now "UM-7 " will be used.

- b) Angular velocities of masses, if requested as per Change 4 above, will appear in the output vector as branch voltages identified by a pair of names. The first of these will be the user-supplied mass name (Change 3), and the second will be blank ("TERRA" in the printed heading). On the other hand, angular velocities can just be node voltages involving the user-supplied mass name, if the user chooses to request such node-voltage output separate from the machine data.
- c) Armature (stator) currents are identified with an extra "P" to indicate the power side of the machine. The former "IA", "IB", and "IC" have become "IPA", "IPB", and "IPC", respectively.
- d) Excitation (rotor) currents are identified by names built around the root letter "E" for "excitation". Both the real field winding, and also fictitious damper windings, are so affected. The former S.M. currents of direct-axis coils, "IF" and "IKD", now are identified using "IE1" and "IE2". Along quadrature axis, the former "IG" and "IKQ" are now identified using "IE3" and "IE4".
- e) The electromechanical torque is now identified by "TQGEN", rather than the original "TQ GEN". That is, the original imbedded blank has been moved to the right. See Change 4.
- f) Etc., etc. Most other changes should be obvious, and require no further explanation here.

ILLUSTRATION EXAMPLE

The included listing shows the complete EMTP data case that needs to be set up to run an SM Type-59 with the UM code. This data case is a copy of the benchmark DC-26 in which for clarity the transmission lines are simplified to linear branches. The listing also shows the headings of the various UM variables and the numerical results of the initial integration steps after completion of the automatic steady-state initialization. The plot output of some relevant machine variables for a single line-to-ground fault with subsequent clearing after 3 cycles, demonstrates that the results of running the same data case with the UM code or the SM code yield an exact match. A match till the last digit can be observed in the numerical output, which is remarkable considering the different approaches of the two codes. This expected discrepancy can be revealed if the rotor moment of inertia is strongly lowered (by a factor of 1,000), leading to a more pronounced electromechanical interaction after the system has been subjected to the single line-to-ground fault. The difference that can be observed is however nevertheless very small and from the practical point of view indeed negligible.

ELECTROMAGNETIC TRANSIENTS PROGRAM (EMTP), DIGITAL (DEC) VAX-11/780 TRANSLATION AS USED BY BPA IN PORTLAND, OREGON 97208: USA.
 DATE (MM/DD/YY) AND TIME OF DAY (HH.MM.SS.) = 07/27/82 10.49.54 VAX/VMS PLOT FILE = 727104954.PL4
 FOR INFORMATION, CONSULT THE 834-PAGE ENTP RULE BOOK DATED APRIL, 1982. PROGRAM VERSION = "M32."
 INDEPENDENT LIST LIMITS FOLLOW. TOTAL LENGTH OF /LABEL/ EQUALS 174414 INTEGER WORDS. 752 900 1500 300 7500
 120 4500 5250 225 480 150 150 15 1200 150 13 0 15 9000 1950 300 450 12000 9 1200 150

 DESCRIPTIVE INTERPRETATION OF NEW-CASE INPUT DATA | INPUT DATA CARD IMAGES PRINTED BELOW. ALL 80 COLUMNS. CHARACTER BY CHARACTER.
 0 1 2 3 4 5 6 7 8
 0 0 0 0 0 0 0 0 0

MARKER CARD PRECEDING NEW DATA CASE. | BEGIN NEW DATA CASE
 COMMENT CARD. | IC TEST CASE FOR RUNNING SM TYPE-59 WITH THE UM CODE
 COMMENT CARD. | IC THE DATA CASE IS COPIED FROM BENCHMARK DC-26 WITH MODIFICATIONS :
 COMMENT CARD. | IC * TRANSFORMER AND PI-SECTION REPLACED BY LINEAR BRANCHES
 COMMENT CARD. | IC * MACHINE VOLTAGE INCREASED BY FACTOR 500 AND ANGLE +60 DEGR
 COMMENT CARD. | IC * INFINITE BUS VOLTAGE INCREASED BY FACTOR 100
 REDEFINED POWER FREQUENCY = 0.500E+02 HZ. | POWER FREQUENCY, 50
 MISC. DATA. 0.200E-03 0.500E+00 0.500E+02 | .000200 .500 50. 50.
 MISC. DATA. 1 1 1 0 1 -1 0 1 0 0 | 1 1 1 1 0 1 -1
 PRINTOUT : 5 5 20 20 100 100 | 1 5 5 20 20 100 100
 COMMENT CARD. | IC TRANSMISSION LINES :
 SERIES R-L-C. 0.100E+00 0.000E+00 0.000E+00 | 1 A1 A2 .1 1
 REFERENCE BRANCH. COPY 'A1 ' TO 'A2 ' | 1 B1 B2 A1 A2 1
 REFERENCE BRANCH. COPY 'A1 ' TO 'A2 ' | 1 C1 C2 A1 A2 1
 SERIES R-L-C. 0.520E-02 0.572E+02 0.000E+00 | 1 A2 A3 .0052 57.15
 REFERENCE BRANCH. COPY 'A2 ' TO 'A3 ' | 1 B2 B3 A2 A3
 REFERENCE BRANCH. COPY 'A2 ' TO 'A3 ' | 1 C2 C3 A2 A3
 SERIES R-L-C. 0.000E+00 0.000E+00 0.314E+02 | 1 A2 31.416
 SERIES R-L-C. 0.000E+00 0.000E+00 0.314E+02 | 1 B2 31.416
 SERIES R-L-C. 0.000E+00 0.000E+00 0.314E+02 | 1 C2 31.416
 SERIES R-L-C. 0.433E+02 0.000E+00 0.000E+00 | 1 A3 A4 43.34
 REFERENCE BRANCH. COPY 'A3 ' TO 'A4 ' | 1 B3 B4 A3 A4
 REFERENCE BRANCH. COPY 'A3 ' TO 'A4 ' | 1 C3 C4 A3 A4
 BLANK CARD TERMINATING BRANCH CARDS. | BLANK CARD ENDING BRANCH CARDS
 COMMENT CARD. | IC NEXT CARD HAS TOPEN = 80 NS MINUS EPSILN TO AVOID DELAYED OPENING
 COMMENT CARD. | IC (HALF A CYCLE!) FOR PRIME AND BURROUGHS! WSH. 27 FEB 1982.
 SWITCH. 0.20E-01 0.80E-01 0.00E+00 0.00E+00 | 1 A3 .01990 .0799
 BLANK CARD TERMINATING SWITCH CARDS. | BLANK CARD ENDING SWITCH CARDS
 SOURCE. 0.11E+04 0.50E+02 -0.20E+02 -0.10E+01 | 114A4 1120.59 50. -20.
 SOURCE. 0.11E+04 0.50E+02 -0.14E+03 -0.10E+01 | 114B4 1120.59 50. -140.
 SOURCE. 0.11E+04 0.50E+02 0.10E+03 -0.10E+01 | 114C4 1120.59 50. 100.
 COMMENT CARD. | IC UM WITH SM TYPE-59 DATA INPUT

J.R. DATA BEGINS. LIST-25 CELLS USED = 317 | 119 UM
 BEGIN U.M. , SM TYPE-59 DATA FOR SOME UM | 1 SHDATA
 BLANK CARD ENDING CLASS-1 UM DATA CARD | BLANK CARD ENDING GENERAL UM SPEC
 UM - 1 SM-59 CLASS 1, CARD 1 | 159A1 5695.05 50.0 +30.0
 UM - 1 SM-59 CLASS 1, CARD 2 | 159B1
 UM - 1 SM-59 CLASS 1, CARD 3 | 159C1
 UM - 1 SM-59 CLASS 2, PAR FIT REQUEST | 1PARAMETER FITTING 1.0

NOTE : THE UM IS NOT PROVIDED WITH AN ITERATIONAL PARAMETER FITTING CODE.

UM - 1 SM-59 CLASS 3, GENERAL PARAMETERS | 1 1 1 2 150.0 13.8 600.0 600.0 720.0
 UM - 1 SM-59 CLASS 3, MANUFACTURE CARD 1 | 1 0.0014 0.175 1.85 1.76 0.2575 1.76 0.18 0.18
 UM - 1 SM-59 CLASS 3, MANUFACTURE CARD 2 | 1 5.74757 0.051142 0.382609 0.197985
 UM - 1 SM-59 CLASS 4, MASS NR. 1 | 1 1 1.0 50.0 1.0 BUSM1
 UM - 1 SM-59 CLASS 5, OUTPUT CARD | 1EXTEND 0 0 0 1 1 1 1 1 1 1
 UM - 1 SM-59 CLASS 5, OUTPUT CARD | 13
 UM - 1 READING COMPLETED | 1 FINISH
 BLANK CARD ENDING UM DATA. | BLANK CARD ENDING ALL UM DATA
 BLANK CARD TERMINATING SOURCE CARDS. | BLANK CARD ENDING SOURCE CARDS

COLUMN HEADINGS FOR THE 20 ENTP OUTPUT VARIABLES FOLLOW. THESE ARE ORDERED ACCORDING TO THE FIVE POSSIBLE ENTP OUTPUT-VARIABLE CLASSES, AS FOLLOWS

FIRST 7 OUTPUT VARIABLES ARE ELECTRIC-NETWORK NODE VOLTAGES (WITH RESPECT TO LOCAL GROUND):
 NEXT 1 OUTPUT VARIABLES ARE BRANCH VOLTAGES (VOLTAGE OF UPPER NODE MINUS VOLTAGE OF LOWER NODE):
 NEXT 3 OUTPUT VARIABLES ARE BRANCH CURRENTS (FLOWING FROM THE UPPER ENTP NODE TO THE LOWER):
 NEXT 0 OUTPUT VARIABLES PERTAIN TO DYNAMIC SYNCHRONOUS MACHINES, WITH NAMES GENERATED INTERNALLY:
 FINAL 0 OUTPUT VARIABLES BELONG TO 'TACS' (NOTE INTERNALLY-ADDED UPPER NAME OF PAIR).
 BRANCH POWER CONSUMPTION (POWER FLOW, IF A SWITCH) IS TREATED LIKE A BRANCH VOLTAGE FOR THIS GROUPING:
 BRANCH ENERGY CONSUMPTION (ENERGY FLOW, IF A SWITCH) IS TREATED LIKE A BRANCH CURRENT FOR THIS GROUPING.

STEP	TIME	A1	B1	C1	A2	B2	C2	BUSH1	A1	A2
0	0.000000	0.493206E+04	0.477514E+04	0.493206E+04	0.492521E+04	0.477514E+04	0.492999E+04	0.314159E+03	0.314159E+03	0.684382E+02
		-0.477514E+02	-0.206868E+02	0.139924E+04	0.121134E+03	0.684382E+02	-0.477514E+02	0.206868E+02	0.309304E+03	0.000000E+00
1	0.000200	0.474353E+04	0.357602E+03	-0.510113E+04	0.473660E+04	0.362045E+03	-0.509865E+04	0.314159E+03	0.314159E+03	0.692840E+02
		-0.444272E+02	-0.248568E+02	0.139921E+04	0.121134E+03	0.692840E+02	-0.444272E+02	0.248568E+02	0.309304E+03	0.913589E-04
2	0.000400	0.453628E+04	0.713781E+03	-0.525006E+04	0.452929E+04	0.717873E+03	-0.524716E+04	0.314159E+03	0.314159E+03	0.698566E+02
		-0.409278E+02	-0.289287E+02	0.139918E+04	0.121134E+03	0.698566E+02	-0.409278E+02	0.289287E+02	0.309304E+03	0.198144E-03
3	0.000600	0.431113E+04	0.106715E+04	-0.537828E+04	0.430411E+04	0.107088E+04	-0.537499E+04	0.314159E+03	0.314159E+03	0.701534E+02
		-0.372667E+02	-0.328867E+02	0.139915E+04	0.121134E+03	0.701534E+02	-0.372667E+02	0.328867E+02	0.309304E+03	0.264668E-03
4	0.000800	0.406896E+04	0.141630E+04	-0.548526E+04	0.406194E+04	0.141965E+04	-0.548159E+04	0.314159E+03	0.314159E+03	0.701736E+02
		-0.334588E+02	-0.367147E+02	0.139913E+04	0.121134E+03	0.701736E+02	-0.334588E+02	0.367147E+02	0.309304E+03	0.349691E-03
5	0.001000	0.381073E+04	0.175987E+04	-0.557060E+04	0.380374E+04	0.176282E+04	-0.556565E+04	0.314159E+03	0.314159E+03	0.699168E+02
		-0.295186E+02	-0.403982E+02	0.139910E+04	0.121134E+03	0.699168E+02	-0.295186E+02	0.403982E+02	0.309304E+03	0.395853E-03

mech speed of generator

phase a & state current

torque angle

electromagnetic torque

field current

damper cure (d-axis)

36m-9

1.63K Multi-Machine System Simulation with the Universal Machine

Hian K. Lauw
Electrical and Computer Engineering
Oregon State University
Corvallis, Oregon 97330
Tel: (503) 754-3617

(I) INTRODUCTION

With the M32 and older versions of the EMTP, the code of the Universal Machine (UM) interface with an electric network is based on multi-phase compensation. This composition method is mathematically pure and elegant, and, is known to result in perfectly stable numerical solutions. It does, however, lead to the restriction that the UM is not allowed to be connected directly to any non-linear element or any other UM. In dealing with multi-machine systems, the electric network needs to be partitioned into subnetworks, such that each subnetwork contains one UM only. The use of stub lines to connect these subnetworks is considered to be a reasonable approach. It is, however, to be realized that a one time-step delay is introduced to the interaction between the machines in the various subnetworks.

With the M33 version of the EMTP, the UM code is extended in order to enhance the flexibility of the UM usage in this respect. An option is now available to the user to have the power coil of the UM interfaced with an external electric network based on prediction, rather than on phase-compensation. Activating this option allows the user to connect directly the power sides of an arbitrary number of UM's to a same electric network. The UM's used may be of different types.

The following report covers the rules and restrictions pertaining to this new option. A new approach to the interfacing based on prediction which does not lead into interface-error amplifications, will be presented. The benefit of this approach is not only restricted to UM modeling, it can be expected to enhance the numerical stability of digital machinery modeling in general. Moreover, experimentations with different prediction methods lead to the conclusion that this approach is crucial in securing the numerical stability of induction and variable speed doubly-fed machine transient modeling.

(II) USER'S RULE AND RESTRICTIONS

RULE: For all UM types including UM usage with SM Type - 59 data input, if column 15 on card 2 of Class 1 UM Data Cards (see EMTP Rule Book April 1982) is:

- (a) left blank, then interfacing of the UM with external electrical networks is fully on the basis of multi-phase compensation (as with the M32 and older EMTP versions),
- (b) set to 1, then interfacing of the power side of the UM with an external electric network is on the basis of prediction.

The following comments regarding the use of this rule can be made:

(1) The terminology of power side of the machine denotes the machine coils which transfer the bulk power of the machine. This is as opposed to the excitation side of the machine, which obviously denotes for synchronous machines the field and damper coils, for induction machines the coils representing a squirrel cage or slip ring rotor, for doubly-fed machines the coils carrying slip frequency currents in steady-state, etc.

(2) Application of Rule (b) allows the user to connect directly the power sides of an arbitrary number of machines to a same electric network. Usage of the UM with SM Type - 59 data input does not require further additional information as will follow next.

(3) Interfacing of the excitation side with any external electric circuit is still based on phase compensation and hence no direct connection to an external circuit containing non-linear elements is allowed for the excitation side. This restriction is kept in place to take full benefit from the perfect numerical stability property of interfacing on the basis of phase compensation. In practice the need rarely occurs to have to connect the excitation sides of different machines to a same electric circuit. For the cases that such a situation has to be dealt with, the stub line approach needs to be pursued. It is remarked that the restriction does not preclude direct connection of the excitation coils to switchings elements, pseudo non-linear elements or even to the electric network to which the power side of the machine is connected, as long as this network does not contain a non-linear element.

(4) Interfacing the UM with the mechanical system for which the mechanical system is simulated by an analog electric circuit, is also based on phase compensation, and is therefore subject to the same restriction as given for the excitation side in comment (3). If more than one UM has to be connected to the same mechanical system (shaft), than either the TACS option or the stub line approach can be pursued.

(5) Interfacing of both the power side and the excitation side with TACS elements follows the usual rules, i.e. this interfacing is not effected by usage of this new option.

(III) APPROACH FOR AUTOMATIC STEADY-STATE INITIALIZATION

Since November 1981, the UM code includes an option for automatic steady-state initialization. The rules for activating this option are described in the EMTP Rule Book. These rules are not changed by activating the option for interfacing based on prediction. Additional codings effort is, however, necessary to cope with multi-machine simulations for which a number of machines, possibly of different types, is connected to a same electric network. The UM steady-state initialization code for induction and doubly-fed machine types was based on the application of multi-phase compensation. Instead of a separate machine by machine initialization approach, the existing code needs to be adjusted to become an integrated initialization procedure for an arbitrary number of machines which are possibly of different types. It is pointed out that as explained in the EMTP Rule Book, a different strategy for initialization of synchronous and induction machine types needs to be pursued. This is to be implemented in the integrated set-up, which basically can be step-wise described as follows:

(1) Find the Norton parameters (current source and admittance) of all induction and doubly-fed machines. Note that in the old procedure the equivalent sources and parameters of the EMTP electric network were to be acquired. This approach is the reason for the prohibition of connecting more than one UM directly to a same network. The Norton parameters of these machine types are easily found from the open and short-circuit machine equations with the machine rotor frequencies given from the user's supplied data. Subsequently the Norton parameters are to be transformed to the frequency domain of the electric network to which the power side of the machine is connected.

(2) Create voltage sources representing user's supplied data for terminal voltage of synchronous or direct current machines.

(3) Solve the steady-state equations of the power electric network with the found machine sources and parameters from Steps (1) and (2).

(4) With the found power circuits and voltages in Step (3), adjust the field currents of synchronous or direct current machines to match the given power quantities. Solve simultaneously all currents of the exciter side of induction and doubly-fed machines.

(5) Solve the steady-state equations of the electric networks connected to the excitation sides of all machines with the results of Step (4).

(6) With the found currents of all machines in Step (4), the electromagnetic torques of all machines are obtained. Sources in the mechanical systems to

accommodate these torques as well as the steady-state calculations of the mechanical system are the final steps to be executed.

It is remarked that the steady-state initialization does not require any prediction nor iterations to arrive at the final solution of all variables.

IV APPROACH FOR INTERFACING BASED ON PREDICTION

Interfacing the machine model with the EMTF electric network model in essence involves the information flow between the two models through sets of dual variables = the machine terminal voltages and current.

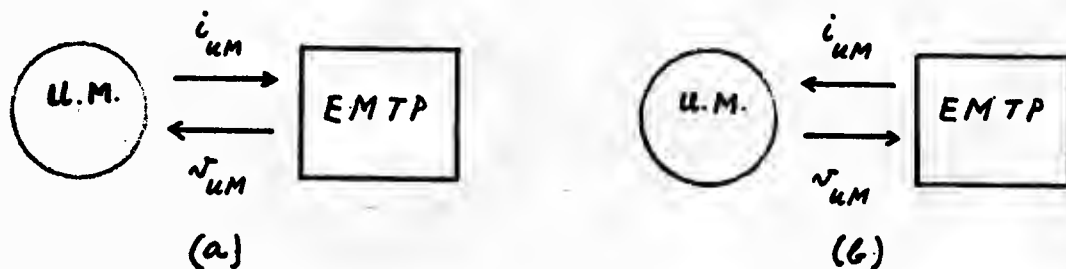

Fig. 1 Interfacing of UM with EMTF

There are seemingly two possible interfacing schemes as indicated in Fig. 1a and b.

- (a) Predict the currents $i_{UM}(t)$ and offer these currents to the EMTF electric network equations for solution of the voltages $v_{UM}(t)$. These voltages are subsequently processed by the machine equations for solution of all machine variables. The process is to be repeated at each time-step. This alternative is not attractive considering the possible switching actions in the electric network.
- (b) Predict the voltages $v_{UM}(t)$ and offer these voltages to the EMTF electric network equations for solution of the currents $i_{UM}(t)$. These currents are subsequently processed by the machine equations for solution of all machine variables. This process is to be repeated at each time-step.

Experimentation with these two interfacing schemes justified the concern of interface-error amplification due to the error introduced by the prediction of either voltage or current. Both alternatives result in an "explosion" after a limited number of integration steps, even in the absence of any switching action in the electric network. In both schemes the currents need to be processed by equations which contain terms requiring the differentiation of the currents. In the "discrete world" this differentiation boils down to the

need of prediction of currents. Careful observations lead to the conclusion that this current prediction is the main cause for the interface-error amplification. It can be remarked that the conclusion merely confirms the expectation that differentiation is extremely prone to noise error amplification.

A slight improvement with nevertheless disastrous results can be achieved by conducting the prediction in the Park domain, i.e. the prediction is to be done on transformed voltages or currents for a reference frame stationary with the rotor.

The Brandwajn interface method (IEEE Paper No. A76359-0., Summer Power Meeting, July 1976, Portland) and a similar interfacing method proposed by Ramanujam (EMTP News, Vol. 3, Aug. 1982, p. 46) are successfully applied to synchronous machines and are in essence based on realizing interfacing scheme (b). However, prediction is carried out in the Park domain and the symmetric part of the machine stator inductances as well as the stator resistances are removed from the machine equations to become part of the EMTP network model. The Brandwajn interface is implemented in the SM Type - 59 code of the EMTP. Crucial to this interfacing method is to just retain the salient part of the inductances within the machine equations. As a result differentiation of the current is now reduced to a small fraction of the so-called transformer voltage term of the machine voltage equations. This method of reducing the influence of terms containing the derivative of the stator currents, apparently does not result in an excessive interface-error amplification. It is, however, necessary to take in some cases certain precautions to avoid this interface-error amplification to become unbounded (EMTP News, Vol. 2, Nr. 3, Feb. 1982).

The approach for the UM interface as based on prediction, reflects a strategy to avoid any current prediction. The prediction realizes interfacing scheme (b), for which prediction is exclusively conducted on the flux linkages of the machines. Moreover, prediction will be performed for the transformed fluxes for a reference frame stationary to the angular speed ω_0 , i.e. corresponding to the frequency of the electric power grid to which the machines are connected. From this point on, this reference frame will be referred to as the ω_0 reference frame. Justification for this approach can be summarized as follows:

(a) Avoiding current prediction secures the suppression of interface-error amplification as has been explained before.

(b) It can be experimentally verified that flux linkages exhibit an extremely smooth behavior even under severe transient disturbances such as a 3-phase short-circuit at the terminals of the machine. It is pointed out here that under such circumstances Park domain currents will be subject to rather severe fluctuations. In fact, observations of the smooth behavior of flux linkages led to the well-known theorem of constant flux as introduced by Concordia, forming the basis for the formulations of transient and subtransient reactances of synchronous machines.

(c) Performing the prediction for transformed fluxes with the ω_0 reference frame is beneficial to the numerical stability of the solutions

since, as will be shown, no additional prediction will be required for the rotor speed nor the rotor position angle. This is not so if prediction is done on Park domain variables. In transforming the predicted Park domain variables back to the real time domain for interfacing with the electric network variables, the corresponding transformation matrix is dependent on the rotor position angle which consequently needs to be predicted also; the rotor speed is to be predicted to determine the so-called speed emf.

(d) Prediction with transformed variables for the ω_0 reference frame, rather than the Park domain reference frame, is crucial to the modelings of induction and variable-speed doubly-fed machines. Even in steady-state the use of the park domain reference frame results in oscillating (slip frequency) variables. These variables transformed into the ω_0 reference domain are constant.

In order to avoid the need of any current prediction, it is necessary to remove the machine power resistances from the machine equations to become part of the EMTF electric network to which the power side of the machine is connected. As opposed to the Brandwajn interface, all machine inductances are kept within the UM module in order to take full benefit from predicting the voltages on the basis of flux linkage prediction.

The following procedure outlines stepwise all calculations to be made at time-step t:

(1) Execute all EMTF electric network calculations from given history functions and sources including the predicted machine voltages "behind" the power resistances. Let's denote this voltage with $v_{p*}(t)$, with index P denoting power and the asterisk denoting the real time domain. Completion of this step yields as output all machine power currents $i_{p*}(t)$, and Thevenin parameters and sources representing the electric networks connected to the excitation side of the machines, as well as the Thevenin parameters and sources representing the mechanical network (unless use is made of the UM option to represent the mechanical system by TACS elements).

(2) Enter the UM module for execution of all machine calculations from given history functions and the output of Step (1). The real time power current $i_{p*}(t)$ given from Step (1) need to be transformed into the Park domain before processing by the UM internal equations which are formulated on the basis of the Park domain reference frame. Let's denote the needed transformation matrix as $P(\theta(t))$, in which θ is the rotor position angle. Thus:

$$i_p(t) = P(\theta(t)) i_{p*}(t)$$

Completion of this step yields all machine power fluxes $\lambda_p(t)$ and all excitation currents in the Park domain at time-step t (see IEEE Transactions on PAS, Vol. 101, June 1982, p. 1342).

(3) Transform the machine power fluxes $\lambda_p(t)$ into the ω_0 reference frame domain to yield $\lambda_{p^{**}}(t)$. It can be easily proved that the needed transformation matrix is the same transformation matrix of Step (2) in which the argument $\theta(t)$ is to be replaced with $\omega_0 t - \theta(t)$. Thus:

$$\lambda_{p^{**}}(t) = P \{ \omega_0 t - \theta(t) \} \lambda_p(t)$$

(4) Predict for the calculation of the next time-step ($t + \Delta t$) the fluxes $\lambda_{p^{**}}(t + \Delta t)$ by linear extrapolation. This yields the machine voltages behind the power resistances $v_{p^{**}}(t + \Delta t)$ from the power voltage equations in the ω_0 reference frame domain:

$$v_{p^{**}} = - \frac{d\lambda_{p^{**}}}{dt} + \omega_0 [G] \lambda_{p^{**}}$$

with $[G]$ a (3,3)-matrix having zero entries, except for entries (2,3) and (3,2) having values -1 and +1 respectively. Hence in terms of difference equations:

$$v_{p^{**}}(t + \Delta t) = [\lambda_{p^{**}}(t + \Delta t) - \lambda_{p^{**}}(t)] / \Delta t + \omega_0 [G] \lambda_{p^{**}}(t + \Delta t)$$

(5) Transform the voltages behind the power resistances as found in Step (4) from the ω_0 reference frame domain back to the real time domain by again using the same transformation matrix of Step (2) in which the argument $\theta(t)$ is simply to be replaced with $-\omega_0 t - \omega_0 \Delta t$. Thus:

$$v_{p^*}(t + \Delta t) = P (-\omega_0 t - \omega_0 \Delta t) v_{p^{**}}(t + \Delta t)$$

(6) Now repeat Steps (1) to (5) to enter all calculations at time-step (t + Δt) and subsequent time-steps.

The just outlined procedure is merely an effort to present the central idea of the interfacing as based on prediction such that it reflects the approach as discussed earlier. For clarity all additional details regarding saturation, residual flux, rotor speed interaction, etc. were left out in the outline. Steps (3), (4) and (5) indicate that the prediction is solely based on prediction of flux linkages, discarding the need for any additional predictions of currents, rotor speeds and rotor angles in order to initiate the calculations of the subsequent time-steps.

362-7

(V) ILLUSTRATION EXAMPLE

In the EMTF News edition of Vol. 3, Nr. 1, Aug. 1982, a report was given concerning the exact match in results of running a synchronous machine Type - 59 data input with either the UM code or the SM Type - 59 code. The UM interfacing code then was fully based on multi-phase compensation. The data case in which a single line-to-ground fault is initiated at 0.02 seconds with subsequent clearing after 3 cycles was rerun, but this time with the UM code using the new option of non-compensated power coils. Fig. 2 shows the results of this run, demonstrating an exact match with the results of running the data case with the fully compensated UM code. The data case is included to the EMTF benchmark cases under the name of DCNEW9. Computation time of the run with the new option is about 80% and computation time of the SM Type - 59 code about 50% of the computation time as needed to run the data case with the fully compensated UM.

A complete match between the outputs of running a data case of an induction machine UM Type 4 with the new option and with full compensation is shown in Fig. 3. This data case is included to the EMTF benchmark cases under the name of DCNEW10. The induction machine is connected to an infinite bus through a linear branch representation of the transmission lines. With an initial slip of 2%, a step-wise torque decrease to near zero-load is initiated at 0.02 seconds. It has been verified that if the prediction were carried out in the Park domain, rather than in the ω_0 reference frame domain (Steps (3), (4) and (5) of section (IV)), then an "explosion" of the solutions would occur in a few integration steps after completion of the steady-state initialization.

Configuration and results of an illustrative 3 - machine system using the new option are given in Fig. 4. Two UM's are synchronous machines of UM Type 1, of which one is an "infinite" mass machine representing a dynamic equivalent of a large outer system. The third UM is an induction machine UM Type 4. No stub lines were used to segregate the machines, the network of connecting transmission lines including transformers was taken to comprise of EMTF linear branches. With an initial slip near zero, the induction machine is subjected to a sudden torque load increase at 0.02 seconds. The results show the successful steady-state initialization, the expected dip in the induction machine voltage as well as the increase of rotor slip frequency after the torque load increase, and ultimately settling down to a new steady-state operation.

ACKNOWLEDGEMENTS

This work has been carried out under contract number DE - AC79 - 82BP28711, a grant awarded to Oregon State University by the Bonneville Power Administration. The author wishes to thank Dr. Tsu-Huei Liu and Dr. W. Scott Meyer for their useful comments and helpful advice in setting up the present new option

36 11-8

to the UM usage. Mr. Renming Ma played an important role in making the extensions to the UM code compatible with other EMTP components. It has been a pleasure to work with Mr. Lian Ho, whose testings of the new UM option on many multi-machine systems were very useful to rid the code of various programming bugs.

36 n-9

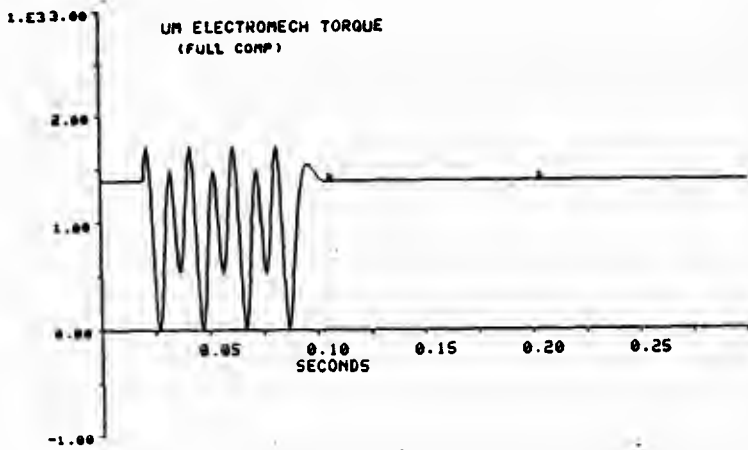

FILE : 11/21/82 20.32.17 TYPE 9
NAMES :UM-1 TOGEN
YMIN, YMAX, DY/IN - -0.1000E+04 0.3000E+04 0.5000E+03
TMIN, TRAX, DT/IN - 0.00000E+00 0.30000E+00 0.25000E-01

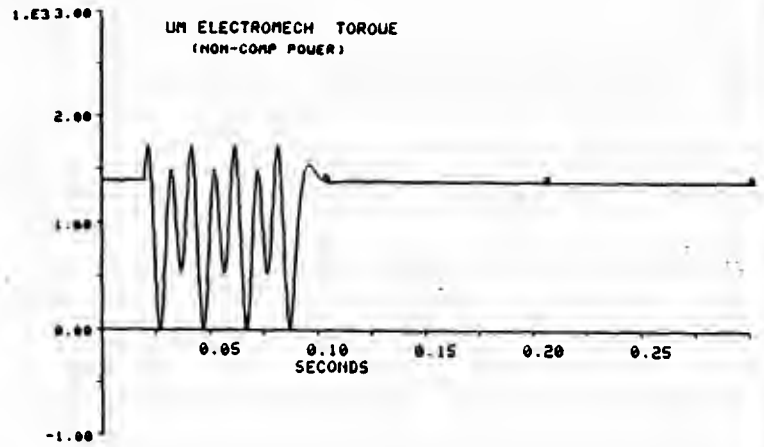

FILE : 11/21/82 20.30.26 TYPE 9
NAMES :UM-1 TOGEN
YMIN, YMAX, DY/IN - -0.1000E+04 0.3000E+04 0.5000E+03
TMIN, TRAX, DT/IN - 0.00000E+00 0.30000E+00 0.25000E-01

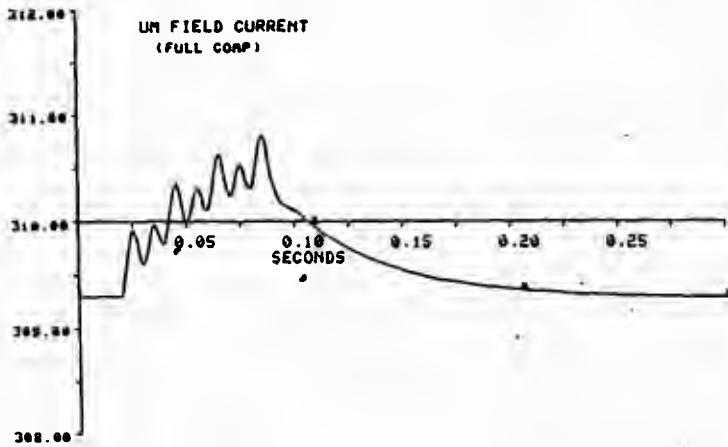

FILE : 11/21/82 20.32.17 TYPE 9
NAMES :UM-1 IE1
YMIN, YMAX, DY/IN - 0.3000E+03 0.3120E+03 0.5000E+00
TMIN, TRAX, DT/IN - 0.00000E+00 0.30000E+00 0.25000E-01

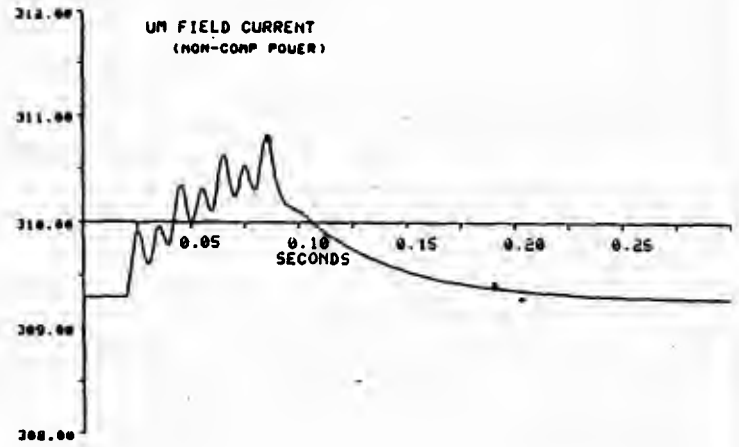

FILE : 11/21/82 20.30.26 TYPE 9
NAMES :UM-1 IE1
YMIN, YMAX, DY/IN - 0.3000E+03 0.3120E+03 0.5000E+00
TMIN, TRAX, DT/IN - 0.00000E+00 0.30000E+00 0.25000E-01

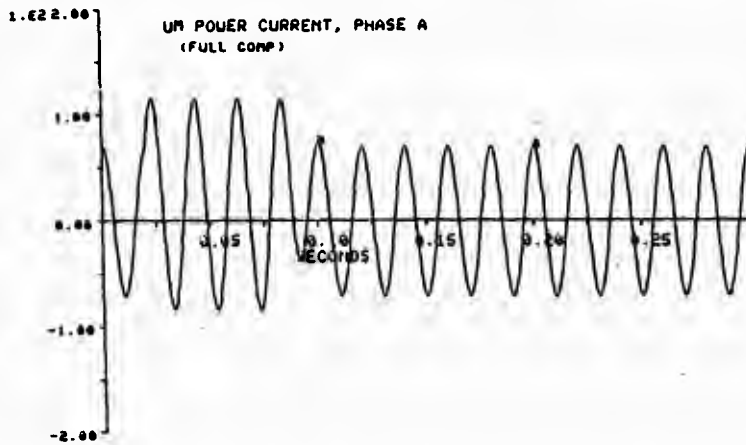

FILE : 11/21/82 20.32.17 TYPE 9
NAMES :UM-1 IPA
YMIN, YMAX, DY/IN - -0.2000E+03 0.2000E+03 0.5000E+02
TMIN, TRAX, DT/IN - 0.00000E+00 0.30000E+00 0.25000E-01

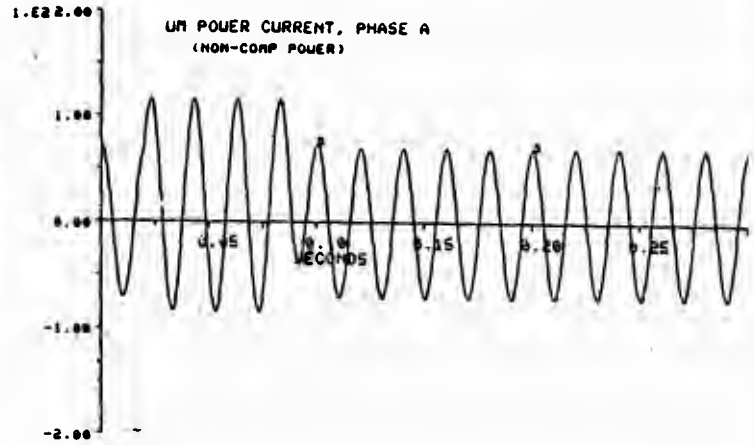

FILE : 11/21/82 20.30.26 TYPE 9
NAMES :UM-1 IPA
YMIN, YMAX, DY/IN - -0.2000E+03 0.2000E+03 0.5000E+02
TMIN, TRAX, DT/IN - 0.00000E+00 0.30000E+00 0.25000E-01

Fig.2 : Benchmark DCNEW9 --- Synchr.Mach (UM Type-1 with SM Type-59 data input)

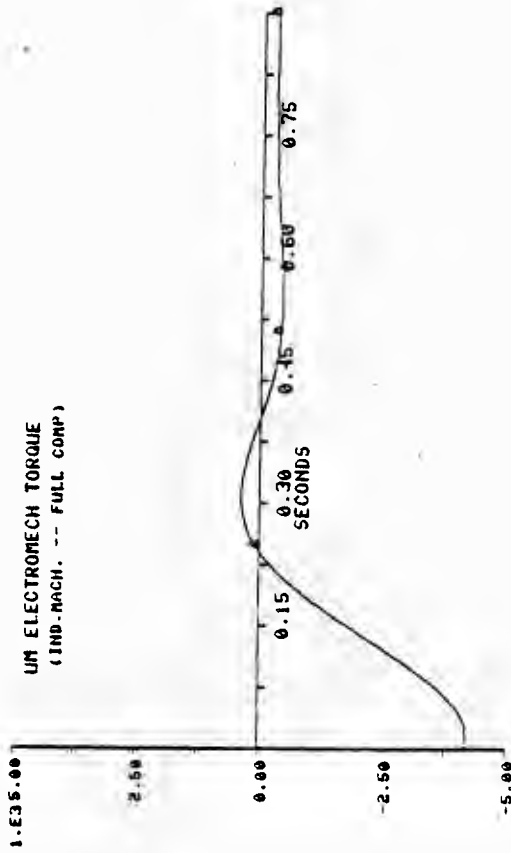

FILE 1 12/21/82 09.05.06 TYPE 9
 NAMES UM-1 TOGEN
 YMIN, YMAX, DY/IN - -0.5000E+04 0.5000E+04 0.1250E+04
 THIN, THAX, DT/IN - 0.00000E+00 0.00000E+00 0.75000E-01

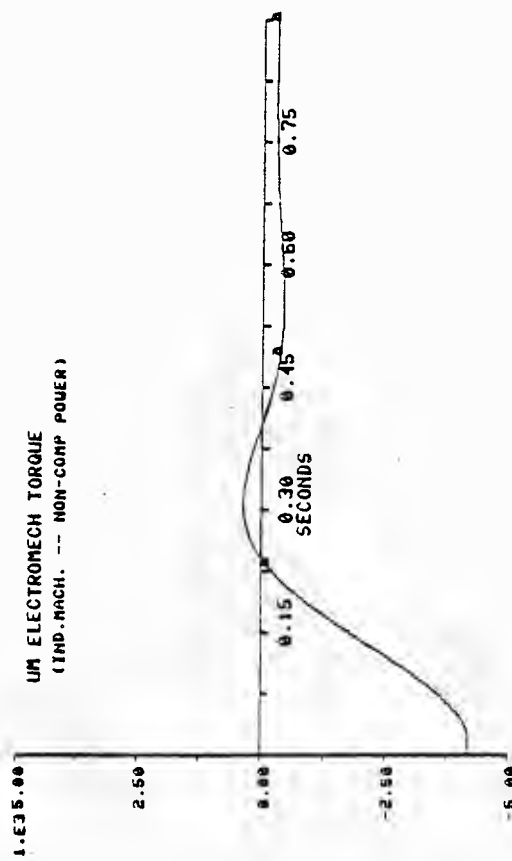

FILE 1 12/21/82 09.57.46 TYPE 9
 NAMES UM-1 TOGEN
 YMIN, YMAX, DY/IN - -0.5000E+04 0.5000E+04 0.1250E+04
 THIN, THAX, DT/IN - 0.00000E+00 0.00000E+00 0.75000E-01

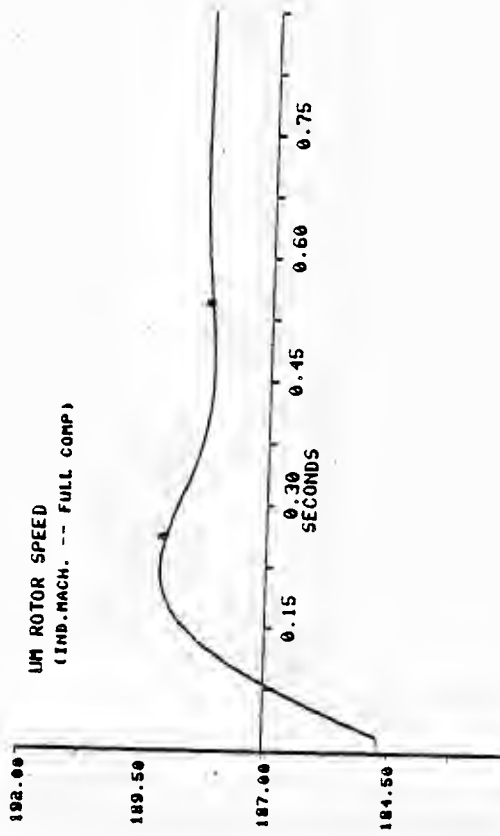

FILE 1 12/21/82 09.05.06 TYPE 0
 NAMES UM-1 OMEGA
 YMIN, YMAX, DY/IN - 0.1820E+03 0.1920E+03 0.1250E+01
 THIN, THAX, DT/IN - 0.00000E+00 0.00000E+00 0.75000E-01

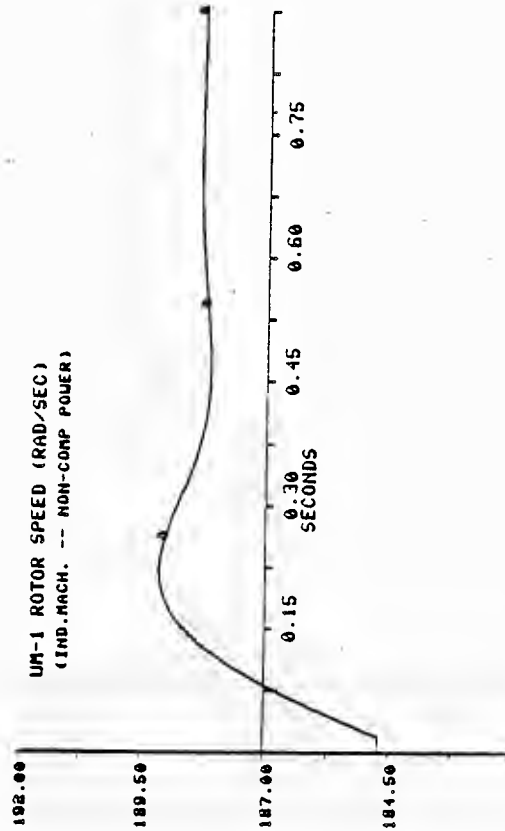

FILE 1 12/21/82 09.57.46 TYPE 9
 NAMES UM-1 OMEGA
 YMIN, YMAX, DY/IN - 0.1820E+03 0.1920E+03 0.1250E+01
 THIN, THAX, DT/IN - 0.00000E+00 0.00000E+00 0.75000E-01

Fig.3 : Benchmark DCNEW10 --- Induct.Mach. (UM Type-4)

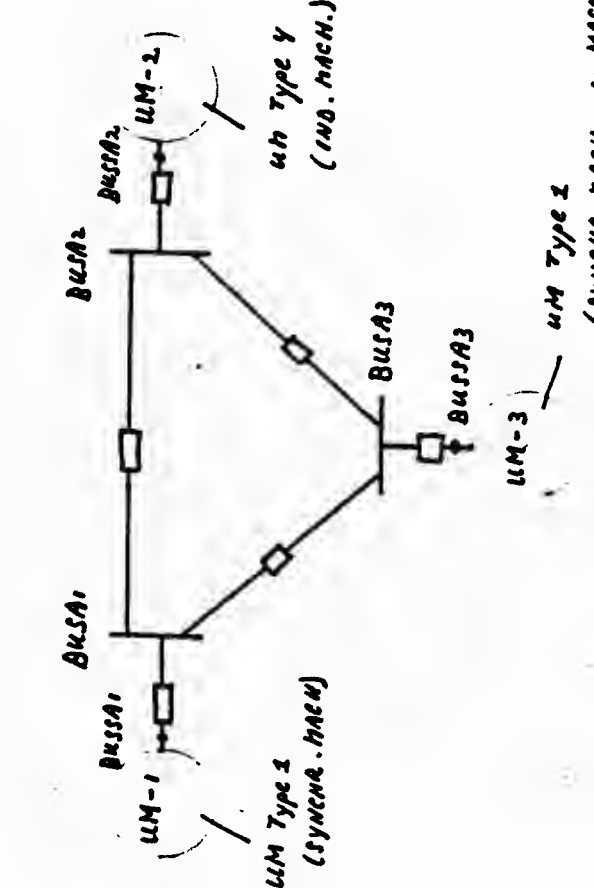
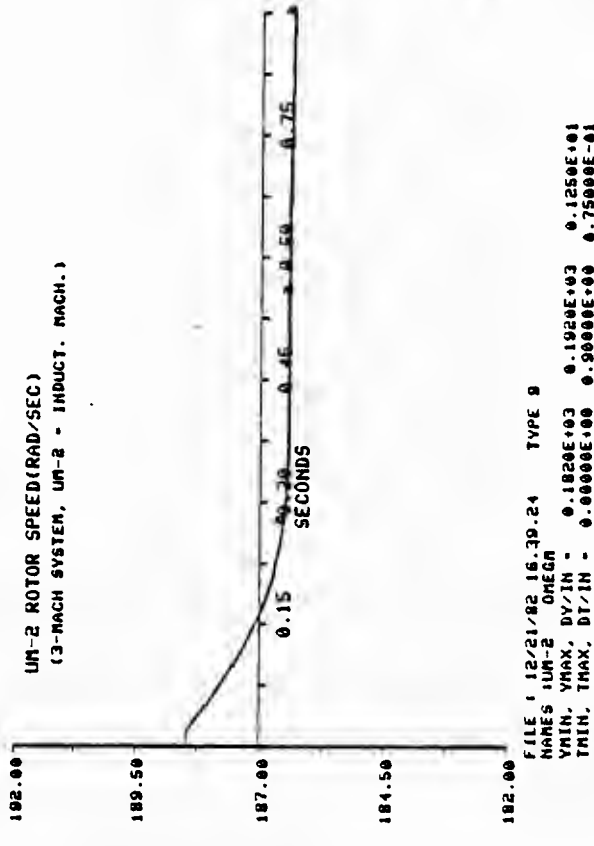
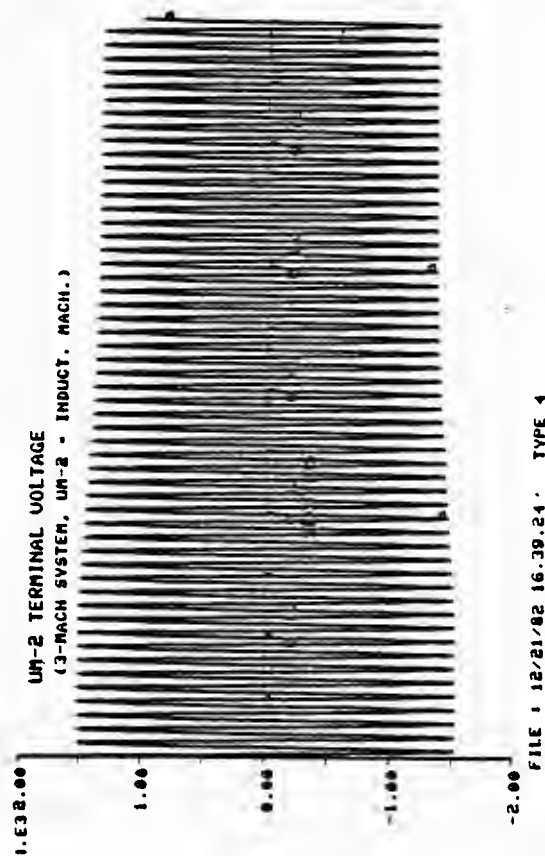
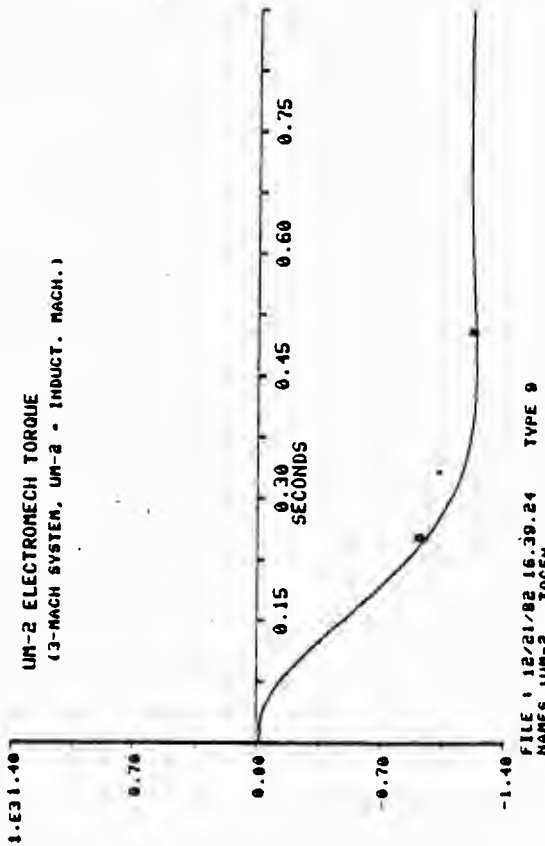

Fig. 4 : 3-mach system simulation with UM

1.63L RECENT DEVELOPMENTS OF THE EMTF UNIVERSAL MACHINE : LOAD-FLOW, MECHANICAL NETWORK SHARING AND SATURATION EVALUATION

Hian K. Lauw
Oregon State University
Department of Electrical and Computer Engr
Corvallis, Oregon 97331
Tel : (503)754-3617

(I) INTRODUCTION

In the M39 version of the EMTF, the Universal Machine (UM) capabilities are extended with certain features which considerably enhance the usage flexibility. These extensions will be covered with particular focus on the option for automatic load-flow initialization and the option for multi-machines to share a common mechanical network (shaft). The rules and restrictions to the use of these options will be presented, including as well a brief explanation with regard to the theoretical background of the chosen approach. The evaluation of the two-segment saturation representation of the UM as compared to a smooth-curve saturation representation will be discussed.

(II) UM INTERFACE WITH LOAD-FLOW

The load-flow feature of the EMTF which has been installed to the M37 version, did not include interfacing with the UM. Benchmark data cases which are to be run with the M39 version, and which demonstrate the correctness and the use of different UM types as initialized by a load-flow are stored in [UM]190.DAT, [UM]UM4901.DAT, [UM]UM4902.DAT through [UM]UM4905.DAT of the BPA Vax computer.

There are no special UM rules for setting up such a data case. The data cards which need to be inserted to the data case to have automatic interfacing of the UM with the EMTF load-flow feature are completely described in the 1984 EMTF Rule Book regarding this load-flow feature. The restriction of the application of this feature to only three-phase systems has the consequence that only UM types with three-phase armatures (power sides) are possible to be initialized by the EMTF load-flow. These UM types are :

- (1) UM TYPE-1 = synchronous machine, 3-phase power coils and arbitrary number of excitation coils.
- (2) UM TYPE-3 = induction machine, 3-phase power coils and arbitrary number of direct- and quadrature-axis excitation coils.
- (3) UM TYPE-4 = induction machine or doubly-fed machine, 3-phase power coils and 3-phase excitation coils.
- (4) UM with SM Type-59 data input.

The following restrictions apply only to the induction and doubly-fed machinery :

(a) For both UM type 3 and 4 the user has the freedom to specify the initial speed of the machine through the usual specification of the initial slip at the assigned data card as described in the general UM data input rules. This specified speed will not be modified by the load-flow calculations.

(b) It is to be realized that the induction machine operating with a given speed behaves exactly like an impedance. Therefore, as is the case with impedances, no direct adjustment of the induction machine power output nor input can be made by the load-flow process. The power flow as well as voltage conditions are in the load-flow process only controllable by available sources in the network such as type-14 sources and obviously synchronous machines.

(c) UM type-3 as well as type-4 can be used to simulate doubly-fed machinery, where both the power and excitation coils are connected in some way to external networks containing certain sources. In this case these UM types could be utilized as controllable sources in the load-flow process. However, only UM type-4 is permitted to be used as such. The UM interfacing logic creates prior to the load-flow calculations the equivalent circuit of UM type-4. The logic also provides the proper connection of this circuit with the electric network on the power side of the machine, and with the electric network on the excitation side of the machine. Consequently, if the user would have included a balanced three-phase set of type-14 voltage sources to the electric network on the excitation side, then these sources may be used in the load-flow calculation process for the purpose of accommodating a desired power flow or voltage condition of the entire electric network (see rules of EMTP load-flow feature). The frequency of these type-14 sources will be automatically adjusted by the UM initialization logic to match the initial slip value as specified by the user with the UM data input in the usual way. It is remarked that obviously the power flow through the excitation coils of the machine is equal to the well-known slip power, i.e. the armature power (power side) times the value of the absolute slip. The use of UM type-3 in the doubly-fed machine mode is in the load-flow process considered to be only equivalent to a fixed impedance and a fixed source.

The theoretical background of the chosen approach for the UM load-flow interfacing can be briefly explained as follows.

The interfacing for the synchronous machine mode of the UM is trivial because the insertion of a single step prior to the existing UM steady-state initialization procedure is all that needs to be implemented. In this step the load-flow calculations are introduced with start values taken from the machine terminal voltages which are specified by the user with the machine data input in the usual way. The machine is represented with a balanced set of three-phase type-14 sources and completion of the mentioned step provides directly the adjusted source arguments corresponding with the desired power flow or voltage condition. The subsequent series of calculations follow the existing logic. From the available information regarding the status of armature (power side) voltages and currents the logic executes the calculations to find the needed excitation voltages and applied torques in order to accommodate these given armature voltages and currents.

The above outlined procedure for synchronous machines is not applicable to induction machines. This was explained in the EMTP Rule Book with regard to the steady-state initialization procedure of induction machines. The reason is the basic fact that induction machines can not be imposed with an arbitrary state of the armature voltages and currents, even if the machine speed (or slip) is assumed to be adjustable from minus infinite to plus infinite. In the theory of induction machines the correlation of the armature voltage and machine currents is captured with the well-known Heyland diagrams. In any event, this phenomenon leads to the need of determining the equivalent impedance or network of the induction machine prior to the initiation of the load-flow calculation process. Extension to induction machines which on the excitation side are connected to an external network containing certain sources (thus doubly-fed machinery), requires the determination of the equivalent sources as well, before the load-flow calculations can be initiated. The determination of these equivalent sources may be omitted if the

equivalent circuit of the machine is created such that a topological connection between the electric networks on the armature (power side) and on the excitation side can be realized. This approach was taken for UM type-4, but is not possible for UM type-3 due to the fact that armature and excitation windings for this machine do not have an equal number of phases.

Rather than adding code to the module "UMRENU" (the UM initialization module) for the purpose of determining these equivalent quantities, a new logic is set up such that the same equations are subjected to a multi-pass procedure, handling the pre-as well as post-load flow calculation process. This effort led to an increase in the efficiency of the existing multi-pass logic and provided a systematic procedure for dealing with multi-machine systems comprising of synchronous as well as induction UM types.

(III) MULTI-MACHINE SYSTEM SHARING COMMON MECHANICAL NETWORK

The UM's in the M38 and older EMTF versions can not be allowed to share a common mechanical shaft due to the phase-compensation method applied to the interfacing of the machine and mechanical system equations. For a different reason, this restriction also holds with all the SM types (50 to 59). The option implemented to the M39 EMTF version allows users to have up to three UM machines of possibly different machine types connected to a single mechanical shaft. The option is however not restricted to such a single shaft connection. It can be applied to a general network of mechanical components, arbitrary in configuration as well as in size due to the UM capability to incorporate the mechanical system as a variably-dimensioned network. Such an example is a wind turbine for which the blades and the hub are critical mechanical components besides the different parts of the turbine shaft.

The current restriction of only allowing three machines to share a common mechanical network may easily be removed in a future version through the use of a variably-dimensioned multi-phase compensation approach.

The option is only honored if the automatic UM steady-state initialization feature is requested with the UM data input (see EMTF Rule book for the rules with this UM usage). This feature is internally called for in the logic if the UM is supplied with SM Type-59 data input, for which this mechanical network sharing option may also be requested (see EMTF Rule Book regarding the rules to run the UM with SM Type-59 data input).

A benchmark data case showing the use and the correctness of this extension to the UM options is stored in [UM]UM191.DAT on the Vax computer of BPA.

The theory behind the chosen approach is a rather straight forward extension of the method for handling the mechanical system of a single UM. It was well documented in a paper by Lauw and Meyer (IEEE Transactions on PAS, Vol 101, June 1982). The method is extended to a three-phase compensation approach, rather than a single-phase one, in interfacing the UM electromagnetic coupling field equations with the mechanical network representation. In addition, linear prediction of the electromagnetic torque production by each UM is included for the purpose of determining the "Thevenin speed" as affected by the other UM's which share the mechanical network. This linear prediction can be expected to be reliable considering its intended use for calculating the speed. Relatively smooth behavior of machines speeds is a reasonable presumption due the relatively higher time-constants of the mechanical network components as compared to those of the electrical network. Extensive experimentations with this new option have confirmed the desired stability of the solutions. In fact, a one time-step delay rather than linear prediction was observed to be sufficient in most practical cases. The

validity of this approach has significant bearing on the efficiency of the computations in that the speed-torque iteration needed within each machine calculation process can be kept uncoupled from each other.

USER'S RULES :

(1) One card, referred to as "share"-card with a format to be described later in rule (5), is needed to be inserted with the data input of each UM which belongs to a set of up to three UM's sharing a common mechanical network. An arbitrary number of these sets can be included to one single data case. The UM's which are not provided with a share-card will be considered to have as usual only one UM connected to the specified mechanical system. Any UM specified in the data case, whether or not it belongs to a set of UM's sharing a common mechanical network, may be connected electrically to each other as with the older EMTF versions.

(2) Insert the share-card as follows :
for UM's with pure UM data input the share-card is to precede card (4) of Class 2 UM data cards,
for UM's with SM Type-59 data input the share-card is to precede the Class 4 SM Type-59 data cards (mass cards).

(3) As with the older EMTF versions, the UM logic assigns a number to each UM, obviously in order to distinguish the one UM from the other. This number is in accordance with the sequence as chosen by the user in specifying the data input of the UM's included to the data case. Awareness of this system of numbering of the different UM's is necessary since identification of the UM's belonging to a set of UM's sharing a common mechanical network will be needed on the share-card.

(4) The UM numbering system as explained in the previous rule is important with respect to the following rules regarding the mandatory structure of each set of UM's sharing a common mechanical network.

(a) It is not required to specify the data input of the UM's belonging to a set sharing a common mechanical network in subsequent order. For instance, if 10 UM's are included to a certain data case and three out of these 10 UM's form a set which shares a common mechanical network, then the order of specifying those three UM's can be chosen to have them become UM number 2, 4 and 8. However, if one of the UM's in this set is a UM provided with SM Type-59 data input, then the data input of this UM has to be supplied in the data case such that it becomes the lowest numbered UM of the UM's which belong to the set. Thus in terms of the example, this UM with the SM Type-59 data input has to become UM number 2.

(b) The relevant information about the mechanical network shared by a set of UM's is required to be supplied to the lowest numbered UM in this set. This is for the case of pure UM data input the bus names of the nodes to which external torques are applied, i.e. card (4) and card (5) of Class 2 UM data cards. For the UM with SM Type-59 data input this information is with respect to the output request and the structure of the entire mechanical network, i.e. Class 4 SM data cards (mass cards).

(c) The information referred to in the previous rule (4b) is to be omitted in the data input of the other UM's in the set which are not chosen to be the lowest numbered UM. This rule is realized by taking the following steps with respect to the data input of these UM's (UM number 4 and 8 of the example in rule 4a) :

< > For UM's with pure UM data input : remove all specifications regarding the external torques applied to the mechanical system by leaving blank the busname "BUSM" on card (4) and omitting completely all cards (5) of the Class 2 UM data cards.

< > For UM's with SM Type-59 data input : remove all Class 4 SM Type-59 Data cards (mass cards).

Note : An important consequence of these rules is that if one of the UM's in the set of UM's sharing a common mechanical network is a UM provided with SM Type-59 data input, then the structure of this mechanical network will be restricted to correspond with the structure of the SM Type-59 mechanical system.

(5) Format of the share-card :

columns 123456789112345678921234567893

type SHARE NUM2 NUM3

format A5 I6 I6

- col 1 - 5 Type SHARE, requesting to have the UM with this card included to its data input share its mechanical network with the UM's which are indicated in the next columns.
- col 7 - 12 Type the number NUM2 in I6 format, which is the number of another UM sharing the mechanical network.
- col 13- 18 Type the number NUM3 in I6 format, which is the number of yet another UM sharing the mechanical network. Leave blank if only two UM's share the mechanical network.

(IV) EVALUATION OF MACHINE SATURATION REPRESENTATION

The machine saturation phenomenon is taken into account by the UM by utilizing a two-segment representation of the saturation characteristic. The representation is extended to three segments if the option of residual magnetism is requested for. The concern here is whether the two-segment representation can be considered adequate and whether a smooth-curve saturation representation should not be pursued instead. A good opportunity for conducting a proper evaluation is provided by the fact that such a smooth-curve saturation representation is implemented to the SM Type-59 code and the fact that the UM is also capable of accepting SM Type-59 data input. The data case [UM]SAT59.DAT version 1 and 2 have been included to the BPA Vax computer to give evidence of the following observations which were made on the basis of output obtained from running the data case with the UM code and thus providing the results of utilizing a two-segment saturation representation, as compared to the output obtained with the SM Type-59 code which provides the results of a smooth-curve saturation representation.

The direct axis saturation parameters AGLD, S1 and S2 are defined with the SM Type-59 data input description in the EMTP Rule Book. Similar parameters are defined for the quadrature axis, which for clarity will be taken out of consideration in the following discussion. These parameters are the constituting parameters for the saturation characteristic and can be briefly reviewed as follows. AGLD is the field current needed to provide 1.0 PU armature voltage in the no-load and unsaturated condition (airgap line). S1 and S2 are defined as to be the field currents causing respectively 1.0 and 1.2 PU armature voltage in the no-load but saturated condition.

The SM Type-59 smooth-curve saturation representation connects points P1 and P2 through a parabolic curve till it hits the airgap line to enter the unsaturated region of the characteristic. The point P1 is the point with ordinates S1 and 1.0 PU armature voltage; likewise point P2 has the ordinates S2 and the 1.2 PU armature voltage.

The two-segment saturation representation of the UM takes the saturated region to be the straight line connecting the points P1 and P2 till it also hits the airgap line to enter the unsaturated region.

The saturation characteristic considered here is a practical curve obtained from an undisclosed machine manufacturer. From this given curve the defined saturation parameters can be found as :

AGLD = 210 A ; S1 = 735 A ; S2 = 1282 A

The saturation level for this characteristic is entered at about 11 KV of armature voltage.

As can be observed from running [UM]SAT59.DAT;2 with the smooth-curve saturation representation of the SM Type-59 code, the machine does not enter the saturation region even if the armature voltage is reduced to 50 percent to the value of 5 KV, which obviously is a highly unrealistic situation. Running the same data case with the two-segment representation of the UM as can be verified from [UM]SAT59.DAT;1 shows the correct achievement of the unsaturated region.

This observation should however not lead to the conclusion that the two-segment saturation representation is to be preferred over the smooth-curve one. Further experimentations show that it is possible to remedy the problem with the smooth-curve representation by adjusting the values of S1 to bring it closer to the value of AGLD resulting in an extremely good match between the output of the UM and the SM Type-59 over the entire saturation region. Moreover, further experimentations have also shown that other saturation characteristics are better realized by the smooth-curve representation than by the two-segment one. This is if the saturation characteristic beyond the value of S2 becomes rather flat. But here also a remedy is found by adjusting the S2 value, this time for the sake of bringing the results with a two-segment representation closer to reality. The conclusion which can validly be taken though is that indeed no preference can be given to the smooth-curve saturation representation. Both representations need adjustments of the S1 and S2 values from those which follow immediately from their definitions. An effort should be made to acquire the whole saturation characteristic rather than just two points in order to intelligently adjust the referred saturation parameters.

Another observation in favor of not extending the current two-segment saturation representation of the UM is obviously the fact that coding is much less complicated. A concern may be raised regarding the operating conditions around the "knee" of such a saturation representation. This has led to extensive experimentation of the behavior of the solution with the UM operating in this region. However, no numerical "noise" problems have been observed and comparing the results on torques and currents with the smooth-curve and two-segment saturation representations show negligible discrepancies. It is only in regions away from this "knee" region that significant discrepancies may be detected. It is however emphasized that as explained before, neither representations can be given preference in this respect and that adjustments to S1 or S2 may be needed with either of the representations in order to achieve realistic results.

(V) MISCELLANEOUS

(1) With the M34 and newer versions of the EMTP, the UM is provided with the capability of accepting SM Type-59 data input. However, the electromagnetic torque as produced by the exciter was supposed to be coded by the user through the use of TACS and only by requesting the Type-80 TACS interfacing with the SM Type-59 data input, the influence of the exciter torque will be taken into account by the UM code. The latest EMTP version does not require the user to use this Type-80 TACS interfacing anymore, neither is it necessary to include any coding within TACS. The

1.66 Data Cards for EMTP Load Flow ("FIX SOURCE" usage)

The steady-state phasor solution for initial conditions of the electric network can be accomplished so as to observe power constraints at one or more busses. By analogy with the dominant steady-state program of system planning departments, this has been named the "load flow" feature of the EMTP. In effect, it is multi-phase load flow capability (albeit in somewhat restricted form) which is now available to the EMTP user.

A. Background Information about EMTP Load Flow

All developmental research and prototype installation and testing of the EMTP load flow logic were performed entirely in Europe, without any association or contact with North America. Availability of the new feature was a complete surprise to us in Portland, when it was first described publicly at the 1983 spring Meeting of the European EMTP Users Group in Arnhem, Holland. Frank Rasmussen of Elkraft Power Company, Ltd., Copenhagen, Denmark, is the author and contributor of this valuable program extension. For background of subsequent adaptation in Portland, see Ref. 8, Vol. XIII, 23 July 1983, Section II, pages VDEL-2 through 9.

Each single-phase node of a network involves four real variables of interest. There is real power injection PK, reactive power injection QK, phasor voltage magnitude VK and phasor voltage angle THETAK. Since there is one real-power and one reactive-power constraint equation for the node, this implies that two of these variables can be specified quite arbitrarily, and the other two can then be solved for. Before the load flow was available, EMTP users could apply only the special zero-power constraint (PK=0 and QK=0, meaning no connection). Control of non-zero power was only indirect, and by trial and error. But now, thanks to the new EMTP load flow, the user can choose among the following constraints at an EMTP source node:

- a) Specify PK and QK; the EMTP solves for VK and THETAK.
This is ordinary load modeling of conventional, single-phase load flow usage by system planning departments.
- b) Specify PK and VK; the EMTP solves for QK and THETAK.
This is ordinary generator modeling of convention
- c) Specify THETAK and QK; the EMTP solves for PK and VK.

There is no limit on the number of busses which are so constrained, although at least one source should be unconstrained. The unconstrained source is commonly is taken as the reference for other phasors (THETAK is fixed at zero). In the terminology of single-phase load flows, this is the "slack bus".

For those who intend to terminate execution once the load flow is complete (i.e., for TMAX non-positive), life is particularly simple. No EMTP source cards are required, and power constraints can be applied to any node of the network. The only program limitation is that the source table (List 4) must be sized to equal or exceed the total number of power-constrained nodes of the network. Why? Because one source is automatically, internally defined for each power-constraint card as it is read in overlay 9.

When a transient simulation is to follow the EMTP load flow (i.e., if TMAX is positive), the user should understand that his power constraints will be forgotten once the time-step loop is entered. With power constraints applied only to nodes with Type-14 voltage sources, the angle and/or magnitude of this source will be automatically adjusted prior to entry into the time-step loop --- adjusted to correspond to the load flow solution. This may or

may not result in approximate continued observance of the steady-state power constraints during the transient simulation. The result is a function of nonlinearities, and of unpredictable transients, which are quite beyond any general analyses. The user should simply keep in mind that load flow constraints only provide for the setting of constants (e.g., generator angles) at time zero, and have no other direct effect on any subsequent simulation.

As presently implemented, power constraints are only allowed at nodes of known voltage, or at the armature nodes of rotating ac machinery. Such constraints can not be applied to current sources. For cases without any associated transient simulation, this is not a restriction, since the required voltage sources are defined internally, to whatever nodes the user wants to apply power constraints. But for cases involving transient simulation, current sources are simply not allowed (i.e., the user can not apply a power constraint to a current source). Perhaps the EMTP could be generalized to handle such cases in the future (Vol. XIII, 23 July 1983, Section II-A, page VDEL-3, middle paragraph), although no plans have been made as of April, 1984, as this page is being written.

A power constraint of the EMTP load flow may only be applied at a network bus. The user can not constrain a line flow, nor can he constrain a group of line flows (the familiar area interchange control), directly. Neither is there any automatic adjustment of transformer or phase shifter taps at the present time. But certain limits on voltage magnitude and angle at a power-constrained node can be observed. First, at a load bus which normally would have PK and QK fixed, the reactive-power constraint will only be maintained within user-specified limits on voltage VK, and the real-power constraint will only be held within user-specified limits on the angle THETAK. Second, at a generator bus which normally would have PK and VK fixed, the real-power constraint will only be held within user-specified limits on the angle THETAK. Third and finally, at a bus which normally would have fixed QK and THETAK (who knows a good, short name for such a bus?), the reactive-power constraint will only be held within user-specified limits on voltage VK. Conspicuous by its absence in this list is the popular choice of system planners for generators: the maintenance of voltage VK with limits on reactive power QK.

Thus far, there has been a mixture of talk about network busses and individual nodes. These may or may not be synonymous, for purposes of EMTP load flow usage. The possible difference is due to multi-phase constraints. The user can gang three nodes together, and control them as a unit, if he likes. In this case, all three voltages are assumed to be balanced, positive-sequence phasors. Any specified real or reactive power is a total 3-phase injection, which will be split equally among the three phases only if the rest of the problem is balanced. But if either the network or some excitation is unbalanced, note that the 3-phase injections will not be balanced, either. In addition to this conventional 3-phase usage, it is possible to drop the third phase (phase "c", which lags phase "a" by 240 degrees), so that only phases "a" and "b" are ganged together. This could be of use to those studying outages (the loss of one phase).

For each network bus which is to have a power constraint, there is one EMTP data card which specifies the associated local control parameters. Following the last such data card, there is an extra card of overall control parameters, which shall be called the miscellaneous data card of the load flow. This data structure is summarized as follows:

```

Card for first power constraint of load flow
    < <  Etc.  > >
Card for last power constraint of load flow
Miscellaneous data card for load flow

```

One 3-phase bus requires only one source card, if the user accepts the 3-phase logic which this implies. Alternatively, each phase could be controlled separately, thereby requiring three EMTF data cards. In any case, taken together, all such cards constitute data peculiar to the EMTF load flow --- data which affects no other aspect of the simulation. This data follows the blank card ending sources (Section 1.6), and it precedes the initial condition cards for the electric network (if any; see Section 1.7) and the node voltage output requests (Section 1.8).

If the user wants such EMTF load flow capability, he must declare his intention early, before the miscellaneous data cards. This is done using a special-request card reading "FIX SOURCE" (see Section 1.0e12a).

All data for the EMTF load flow except the final miscellaneous data card are read within overlay 9 (by module "OVER9"). The miscellaneous data card is read within SUBROUTINE FXSOUR of overlay 10 to complete the data input. Module "FXSOUR" also contains all logic for the network solution which observes power constraints. An impedance matrix algorithm is used, but with a complete simultaneous solution (rather than the adjustment of one equation at a time), which allows the exploitation of the already-calculated and triangularized nodal admittance matrix [Y]. The solution is iterative, then, with convergence less than certain, and not always speedy. But, for practical, realistic cases of common interest, performance has been found to be good, so any user who really wants to begin his transient simulations with given power flows is urged to give the EMTF load flow a try. As long as X/R ratios are reasonable (do not try the EMTF load flow for purely resistive networks!), and a solution exists, and the guess is not unreasonable, then there would seem to be a good chance of success.

Iterative convergence of the EMTF load flow is monitored on LUNIT6, where the largest correction of each iteration is displayed, 20 numbers per line. There also is an option (see miscellaneous data parameter NNNOUT) for the parallel printing of the numbers of the power constraints which produced these greatest corrections. Numbering of this identification corresponds one-for-one with the user-inputted data cards. As an example of such output, consider the first eight columns of the first two rows of twenty, which might appear as follows (taken from BENCHMARK DC-26):

```
VCHANG(K)= 0.016 0.015 0.014 0.013 0.013 0.012 0.012 0.012
FIX SOURCE 1 1 1 1 1 1 1 1
```

Note that convergence is slow (a characteristic of the "crummy" Z-matrix iteration which is used), and that the generator having the worst correction is always the same (DC-26 involves just a single load flow source). If program output goes to the disk, then the user will not see such output until later, so timing is irrelevant. But if output goes to a CRT, then the timing of the display is important. At most 20 iterations will occur between such outputs, thereby assuring the user that the computation is progressing. The user has control over the frequency of this output (variable NFLOUT of the miscellaneous data card which will be described shortly), and if he wants, can see the result after each iteration, when one more number is added to the partial line.

It is important that the load flow user check for convergence, since as presently implemented, the EMTF simulation will continue whether the iteration has converged or not! Should the user-supplied control tolerances not all be met, a warning message will be printed. But execution will not be stopped.

The load flow user may have special interest in knowing the solution at HIS power-constrained busses. Such special output is possible, via variable

NPRINT of the miscellaneous data card (the final data card of the load flow). Such output precedes the phasor branch flows, with the following being a representative sample:

ROW	NODE	NAME	VOLTAGE	DEGREES	REAL POWER	REACTIVE POWER
4	8	A1	0.113908E+02	-30.000	0.399846E+02	-0.451654E+01
5	9	B1	0.113908E+02	-150.000	0.399846E+02	-0.451654E+01
6	10	C1	0.113908E+02	90.000	0.399846E+02	-0.451654E+01

Yet there is really nothing special to see, since such phasor values have always been available via the regular steady-state printout (e.g., by the display of injections which follow phasor branch flows).

Examples of EMTP load flow usage can be found in standard test cases BENCHMARK DC-25 and DC-26, which involve synchronous machines. Since the Type-59 S.M. is represented by nothing other than three Type-14 sinusoidal sources in the steady-state, it is trivial to apply power constraints to these using EMTP load flow capability. The U.M. is not quite so simple, due to its generality; but it, too, is now compatible with the EMTP load flow for induction and synchronous modes, as documented in Prof. Lauw's paper (Ref. 22, May 1984). See the reproduction of this in Section 1.63L for details.

B. Format of Data Cards for EMTP Load Flow

First, there must be one data card for each power constraint. Ordering of these cards is arbitrary. Each such data card is to be punched according to the following rules:

1	2	3	4	5	6	7	8	9	10	11	12	13	14	15	16	17	18	19	20	21	22	23	24	25	26	27	28	29	30	31	32	33	34	35	36	37	38	39	40	41	42	43	44	45	46	47	48	49	50	51	52	53	54	55	56	57	58	59	60	61	62	63	64	65	66	67	68	69	70	71	72	73	74	75	76	77	78	79	80
12	NEK	BUS1	BUS2	BUS3	P _k or Q _k	Q _k or V _k	V _{min}	V _{max}	θ _{min}	θ _{max}																																																																					
	A6	A6	A6		E16.0	E16.0	E8.0	E8.0	E6.0	E6.0																																																																					

NEK --- Type code of power constraint. Choose among:
 (1-2) 0 to constrain PK and QK (unknown VK, THETAK);
 1 to constrain PK and VK (unknown QK, THETAK);
 2 to constrain QK and THETAK (unknown PK, VK).

BUS1 --- Enter the one, two, or three names of network nodes
 (3-8) which are involved in this power constraint. For
 BUS2 single-phase usage, leave BUS2 and BUS3 blank. For
 (9-14) 3-phase usage (the other common case), name the
 BUS3 three nodes in natural, positive-sequence order
 (15-20) (first "a", then "b", and finally "c").

PK or THETAK --- a) In case injected real power PK is to be
 (21-36) constrained (for NEK=0 or 1), punch the desired
 value in units of power (units of voltage times
 units of current, whatever that might be for the
 user's problem). For a multi-phase constraint,
 this is the total of the two or three individual
 injections at the bus of interest.

b) For the remaining, less-common case having
 NEK=2, punch the desired fixed angle THETAK in
 degrees.

- NFLOUT --- The buffer size for accumulating the output which
(25-32) is associated with the interactive convergence monitoring (the worst correction at each iteration). Any non-positive value, or any value in excess of 20, will be set equal to the default value of 20. Since exactly 20 numbers fit on a line, a value of 20 corresponds to waiting for a line to be filled before the user is shown any of the contents. Positive values less than 20 should generally be used only for computers having CRT displays which honor the "1H+" carriage control (for overprinting), since such a device is used to avoid line feeds after such partial outputs. A value of 20 is always best for batch-mode solution.
- NPRINT --- A binary flag which allows for the selection or
(33-40) suppression of special tabular printout for the nodes with power constraints. Punch unity to obtain such values (VK, THETAK, FK, QK); zero or blank will suppress such solution output.
- RALCHK --- A relative convergence tolerance which controls the
(40-48) accuracy of the solution. For termination of the iteration, all power mismatches must be less than RALCHK times the largest scheduled power (either P or Q) of the network. A non-positive value will be taken as a request for the default value 1.E-2.
- CFITEV --- "Acceleration factor" associated with the conversion
(49-56) of a change in reactive power to a change in voltage magnitude. See Ref. 43 for a more precise definition. In the absence of knowledge about this parameter, leave the field blank (which represents a request for the default value of 0.2).
- CFITEA --- "Acceleration factor" associated with the conversion
(57-64) of a change in real power to a change in voltage angle. See Ref. 43 for a more precise definition. In the absence of knowledge about this parameter, leave the field blank (which represents a request for the default value of 2.5).

1.7 CARDS FOR OVERRIDING INITIAL CONDITIONS

These cards are used only if the user wants to supply initial conditions himself. The transients program starts from correct initial conditions as long as everything was zero at $t < 0$ or if an ac steady-state existed at $t < 0$ (the latter is simply indicated by TSTART < 0 on sinusoidal source cards)

Initial conditions that are neither zero nor ac steady-state must be supplied as input. Any initial conditions that are provided through input will override the respective zero-or ac-steady-state initial conditions computed by the program. There are two cases where the user might want to supply the initial conditions:

- a) Continuation of a previously run case, where a continuation beyond t_{\max} was already contemplated. The continuation can either use the same Δt or a changed Δt . Continuation is handled by having the preceding run punch the voltages and currents at the very last step (see section 1.1). Then simply use this data deck in the new run (no blank card at end!). Note that continuation works only if
 - (1) the passive network has not been changed between the previous and the new run, including the order in which the branch cards are read in, and
 - (2) there are no branches with distributed parameters (in this case the punching in the previous run would have been interrupted; see section 1.1).

- b) New Case: If the user knows the initial conditions for a new case, he can supply them as part of the input. This could be used to start a case from steady-state conditions with more frequencies than the fundamental (example: steady-state performance with a number of super-imposed harmonic sources); however, the user has to find the initial conditions himself (an extension of the automatic ac steady-state solution to the case of super-imposed sinusoidal sources with differing frequencies is planned). Note that zero initial conditions or ac steady-state conditions at only one frequency are automatically handled by the program.*)
 Trap charge: Supply all voltage values at nodes with trap charge (steady state frequency = 0 or blank on very first voltage card). Supply cards for currents in linear branches having trap charges (only node names must be listed and fields A, B, C, D are left blank if initial currents are zero).

a) RULES:

- (1) In networks containing branches with distributed parameters, only dc or ac-steady-state solutions can be used as initial conditions. In this case, all initial voltages and currents must be specified as phasor values $x(0) + jy(0)$, where $x(0)$ is the instantaneous value at $t = 0$ (note that the magnitude of the phasor quantity is the crest value and not the rms value). Punch the steady-state frequency into the very first card with an initial node voltage on it.

*) It is advisable to let the program determine initial conditions whenever possible, that is for ac steady-state as well as for dc steady-state. In the latter case, use cosine functions with very low frequency to simulate dc sources. $f = 0.001$ Hz worked very well in studies on the HVDC Pacific Intertie.

- (2) In networks without distributed parameters, any initial conditions are acceptable. In this case, all initial voltages and currents are specified as instantaneous values $x(0)$ (ignore format fields provided for the imaginary part $y(0)$ of phasor values and the steady-state frequency as described in rule 1).
- (3) Stack cards for initial conditions in the following order: Cards for node voltages ("2" in column 2), then cards for currents in linear branches ("3" in column 2), and finally cards for currents in nonlinear and time-varying branches ("4" in column 2). This order is mandatory, since the program computes initial conditions in a branch from the currents on the card plus the node voltages already read in. If cards for node voltages were read in behind cards for branch currents, then the program would assume voltages zero at both ends of the branch. If there are parallel branches with identical node pairs, then all initial conditions on the "3"-cards go into one branch only, namely into the first one encountered in the branch list. In general, this produces wrong initial conditions (please contact the Method Analysis Unit if this problem comes up. If there are only 2 branches in parallel, then the problem can be avoided by identifying the branches with the node pairs in reverse order, say 1st branch "R to L" and 2nd branch "L to R". This makes the 2 branches distinguishable for the "3"-cards).

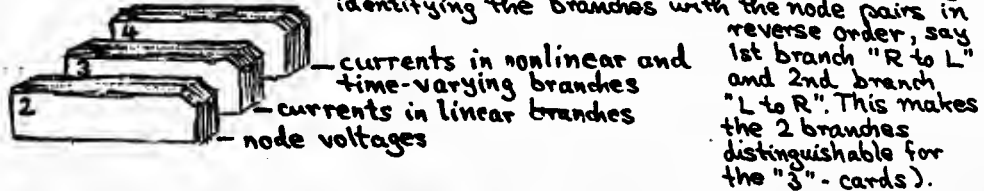

b) FORMAT:

(1) Card for node voltages ("2" in column 2):

1	2	3	4	5	6	7	8	9	10	11	12	13	14	15	16	17	18	19	20	21	22	23	24	25	26	27	28	29	30	31	32	33	34	35	36	37	38	39	40	41	42	43	44	45	46	47	48	49	50	51	52	53
IDENTIFICATION	NODE NAME	Re{E(0)} or e(0)												Im{E(0)}												f in HZ on first card in this stack of node voltage cards																										
	2 A6	E I S . 8												E I S . 8												E I S . 8																										

f = steady-state frequency (punch only on very first card, and only in cases where branches with distributed parameters are present)

$$\text{Re}\{E(0)\} + j\text{Im}\{E(0)\} = \text{phasor voltage at } t = 0 \text{ (rule 1)}$$

$$e(0) = \text{instantaneous voltage at } t = 0 \text{ (rule 2)}$$

(2) Card for linear branch currents ("3" in column 2):

1-2	3-8	9-14	15-29	30-44	45-59	60-74
ID.	1st NODE k	2nd NODE m	A	B	C	D
3	A6	A6	E I S . 8	E I S . 8	E I S . 8	E I S . 8

Format:

Sequence of node names on this card and on associated branch card (section 1.2) must be identical (example: if branch card says "L" to "R", then punch "L" to "R" and not "R" to "L").

a) Lumped series R-L-C: No card necessary if branch is purely resistive ($L = 0$, $\frac{1}{\omega C} = 0$) or if current through branch plus

capacitor voltage are both zero; otherwise punch

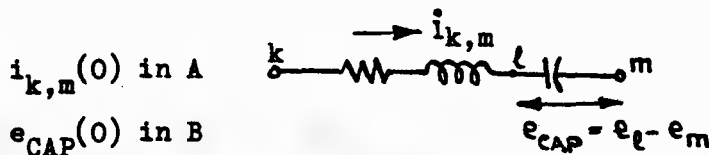

b) Single or multiphase Π -equivalent:

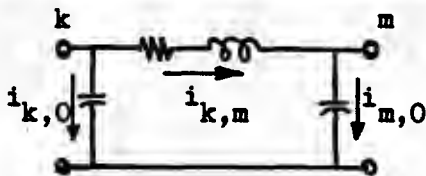

Punch $i_{k,m}(0)$ in A
 $i_{k,o}(0)$ in B
 $i_{m,o}(0)$ in C

Note: Data-input listing interpretation of the 1st distributed-parameter line card reads "LINEAR I." ; interpretation on the 2nd and later such cards of a multi-phase line reads "DISTRIB. I." .

This card must be punched in case of non-zero terminal voltages, even if all currents are zero; otherwise all initial conditions in the circuit, including charges on the capacitors, will be set to zero.

For multiphase Π -equivalents, punch a card for each phase in same phase sequence as branch cards were read in. Here, $i_{k,o}$ is the total shunt current going to ground and the other phases.

c) Single or multiphase line with distributed L' , C' :

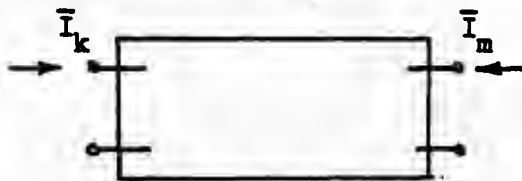

Punch: $\text{Re}(\bar{I}_k)$ in A
 $\text{Im}(\bar{I}_k)$ in B
 $\text{Re}(\bar{I}_m)$ in C
 $\text{Im}(\bar{I}_m)$ in D

See rule 1 why phasor values must be given. This card must be punched in case of non-zero terminal voltages, even if all currents are zero. For multiphase lines, punch a card for each phase in same sequence as branch cards were read in.

(3) Card for nonlinear and time varying branch currents ("4" in column 2):

1	2	3	4	5	6	7	8	9	10	11	12	13	14	15	16	17	18	19	20	21	22	23	24	25	26	27	28	29	30	31	32	33	34	35	36	37	38	39	40	41	42	43	44
IDENT	1st NODE		2nd NODE		$i_{k,m}$																$\psi_{k,m}$																						
	k		m		in units of current																in (units of voltage) · S																						
4	A6		A6		E15.8																E15.8																						

Format:

Leave $\psi_{k,m}$ blank and supply $i_{k,m}$ only as long as $\psi_{k,m}$ can be obtained from the nonlinear characteristic (see Fig. a). Supply $\psi_{k,m}$ if $i_{k,m}(0) = 0$ and characteristic has infinite slope at $i = 0$ (see Fig. b).

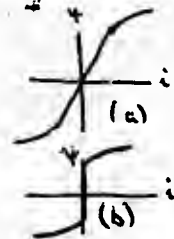
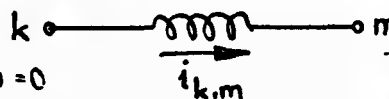

Incomplete initial-condition specification capability (WARNING)

Unfortunately, the manual specification of initial conditions (as per Section 1.7) is not possible at the present time for many EMTP components. Specifically excluded are the following components:

- a) Saturable "TRANSFORMER" component of Section 1.25 ;
- b) Recursive convolution frequency-dependent line modeling of Section 1.27 . Well, actually, sinusoidal initial conditions (past history) is possible, for those who know how. But the format shall not be explained here.
- c) Type-99 pseudo-nonlinear resistance of Section 1.28 ;
- d) Type-98 pseudo-nonlinear reactor of Section 1.29 ;
- e) Type-97 staircase resistance of Section 1.30 ;
- f) Type-94 SiC surge arrester of Section 1.34 ;
- g) Type-16 controlled dc voltage source of Section 1.61 ;
- h) Dynamic synchronous machine (S.M.) components of Section 1.62 ;
- i) TACS modeling (see Section 8.4 for TACS own steady-state initialization rules)

Hence, for typical, modern production studies, the manual specification (override) of initial conditions is not possible. This is as of May, 1980 ("M27." idents).

As for the future, plans are to expand the initial condition input capability so as to handle all possible EMTP components under all possible conditions. Yet, it is not expected that the user will actually punch such initial condition cards himself, manually. For one thing, the operation is tricky and error prone at best, based on BPA experience; for large cases, it is extremely tedious; and for non-sinusoidal past history of distributed components or delay lines, the data is voluminous and impossible to calculate by hand anyway. So, such initial condition cards will be punched by the EMTP itself, as terminal conditions of a simulation which has been stopped by the user. This capability is seen to be a crucial ingredient of a real-time EMTP simulator package, which will be fully interactive. Stay tuned!

=====
Retraction of plans for initial-condition completion
=====

The preceding hopeful paragraph remained true until the spring of 1981, when a new concept of interactive control was discovered. This is what we now refer to as "EMTP simulators" ---- implemented for our VAX-11 using shared COMMON. See the 38-page memo which begins Vol. XI EMTP Memoranda for a complete description (Ref. 8, 17 July 1981, pagination IEE0). Separate program "EMTPSPY" provides the interactive control and observation.

Current thinking is that "EMTPSPY" allows enough interactive control and modification so as to doom the completion of initial-condition usage as at the top of this page. It has the advantage of avoiding a 2nd or later pass through overlays 1-15, thereby making the continuation almost instantaneous. The interactive control and observation is far more powerful, for those variables which are not buried within derived symbols. On the other hand, buried variables can not practically be changed yet, so structural modifications to unearth critical parameters of interest (e.g., "DELTAT") are now being considered. Anyway, pre-1981 plans have been abandoned.

1.8 OUTPUT-VARIABLE SPECIFICATION CARDS

The time response of the electric network being solved is available for the user's inspection via any of the four procedures which follow:

- Output type 1 : Tabulated decimal numbers, from the line printer.
- Output type 2 : Graphs produced on the line printer (so-called "printer plotting" of the solution).
- Output type 3 : Pen and ink graphs, produced by the Calcomp x-y plotter.
- Output type 4 : Graphs drawn on a CRT screen (and preserved permanently by means of an attached hard-copy unit), according to commands which are issued interactively by the user.

Output types 1 and 2 are of course available to every user of interest, since they require only a 132-column line printer. Output type 3 can be utilized only by those having a pen-and-ink plotter which can be controlled through Calcomp subroutine calls. Finally, output type 4 is available only on systems having a CRT terminal with vector-graphics capability, and for which the appropriate special interactive CRT plotting program has been written. As of December 1975, output type 4 has been activated only for a CDC computer and Tektronix CRT terminal, as in operation at EPA in Portland, Oregon (see Ref. 8, January 25, 1975).

In any case, the user can only look at variables for which output requests have been made as part of the data case. The procedure for doing this depends upon whether a conventional single deterministic simulation is involved, or on the contrary, a statistical overvoltage study:

1.8a Output-Variable Specification for Conventional Data Cases

Variable values for voltages, currents, powers, and/or energies are computed by the EMTP at discrete time instants $t = 0, \Delta t, 2\Delta t, \text{ etc.}$ Such values are then either printed (with frequency controlled by miscellaneous data parameter "IOUT" ; see Section 1.0h), or they are written to disk via logical unit number 4 with frequency "IPILOT" (miscellaneous data parameter; see Section 1.0h), for purposes of later plotting after the simulation is finished. In any case, any variables to so be outputted must be specified by the user, as follows:

Node voltage output

As per Point a-7 of Section 1. , the user must input one or more cards specifying all node names for which he will print or plot the node voltages (voltage to ground).

- a) All node voltages desired: Punch a single output specification card, with just a "1" in column 2 ; do not terminate with a blank card.
- b) Selective node-voltage output: List the node names on one or more cards which have columns 1-2 blank, with at least the first field (variable BUS1 , read from columns 3-8) non-blank. Terminate such cards by a blank card.

1	2	3	4	5	6	7	8	9	10	11	12	13	14	15	16	17	18	19	20	21	22	23	24	25	26	27	28	29	30	31	32	33	34	35	36	37	38	39	40	41
Names of nodes having voltage output																																								
		BUS1	BUS2	BUS3	BUS4	BUS5	BUS6	...																																
		AG	AG	AG	AG	AG	AG	...																																

Note that of the 13 potential fields per card, only the first must always be non-blank (except for the terminating blank card, of course); otherwise fields can randomly be left blank, and will be passed over. For example, the following three cards request node-voltage output for the six nodes named ALPHA, BETA, GAMMA, DELTA, PSI, AND ZETA :



- c) No node voltages desired: Supply just a single blank card (which is taken as the blank card ending the non-existent selective node-voltage specification cards).

Branch outputs

Branches and/or switches which are to have output were flagged by column-80 punches as the branch cards were inputted; hence no further specification is required at this point.

The printed heading for branch-variable output consists of pairs of node names, one above the other. This ordering (upper to lower) indicates the polarity of the output. Suppose that node k represents the upper node of the pair, and node m the lower one; then

- a) Branch voltage output is $v_{km}(t) = v_k(t) - v_m(t)$
- b) Branch current output is $i_{km}(t)$, the flow from node k to node m.

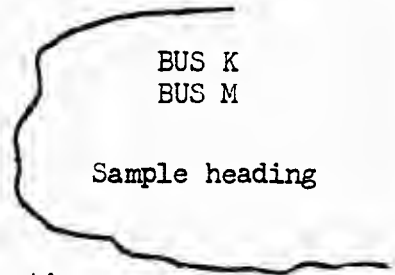

For non-switch elements, power and energy which are outputted represent the consumption (loss or storage) of the branch, the net flow into the branch from time zero (t=0) up to the time in question. For switches, the power and energy are flows through the switch:

- c) Switch power output is $P_{km}(t) = P_k(t) - P_m(t) = v_k(t) \cdot i_{km}(t)$
- d) Switch energy output is $E_{km}(t) = \int_0^t P_{km}(\xi) d\xi$.

NOTE: In addition to just-mentioned column-80 punches, users can request branch and switch outputs along with node-voltage outputs. The format for this added alternate branch and switch output capability is as follows:

	1	2	3	4	5	6	7	8	9	10	11	12	13	14	15	16	17	18	19	20	21	22	23	24	25	26	27	28	29	30	31	32	33	34	35	36	37	38	39	40	41	42	43	44	45	46	47	48
I T Y P E	Names of Branches or Switches																																															
	NAM1	NAM2	NAM3	NAM4	NAM5	NAM6	...																																									
I2	A6	A6	A6	A6	A6	A6	...																																									

- a)
- | | | |
|-------|---------|--|
| ITYPE | -1 ---> | Only current outputs for branches or switches |
| | -2 ---> | Only voltage outputs for branches or switches |
| | -3 ---> | Current and voltage outputs for branches or switches |
| | -4 ---> | Power and energy outputs for branches or switches |
- b) List the 6-character names of branches or switches (Section 1.-E) on one or more cards beginning in column 3. Of the 13 potential names per card, any blank ones will be ignored by the program.
- c) The user can mix any branch or switch output request cards with any node voltage output request cards.
- d) If selective node voltage output requests exist, then one blank card is needed to terminate the specification of EMTP output variables.
- e) On the other hand, if the user has requested the output of all EMTP node voltages by means of a "1"-punch in column 2, then:
- 1) If this "1"-punched card is the last output request card, then do not follow by a blank card. But on the other hand,
 - 2) If this "1"-punched card is not the last output request card, columns 3 through 8 of this card must be non-blank. Also, a terminating blank card must follow the last EMTP output request card.

Following are two examples of the output request cards:

```

1 XXX
-2BRCH10 BRCH30
-1SWCH1 SWCH2 SWCH3
-3 BRCH20
-4 BRCH40
BLANK CARD TERMINATING OUTPUT REQUEST

-1BRCH1 BRCH2
-3BRCH20
-2BRCH1 BRCH3
1

```

Plotting creates no special problem, unless output for parallel branches should be requested. Then as per Rule 3 of Section 1.10, only the first current (energy) output of the two in parallel is accessible to the user at the present time. Later, when plotting is extended to permit variable identification by branch or switch name, this limitation will be removed.

As a practical restriction, the above limitation is not serious. One can always insert a near-zero-resistance branch, thereby eliminating any parallel connection. For example, should power $P(t)$ and energy $E(t)$ be desired for a nonlinear resistance --- in addition to the branch current and voltage --- the configuration shown below could be used. Resistance R_2 is chosen to be "small," in accord with the rule concerning system-dependent minimum values (see Section 1.21). Current output (a 1-punch in column 80) is requested on the branch card for resistance R_2 . Resistance R_1 can be chosen to be very large, and branch voltage output is to be requested for it (a 2-punch in column 80). The nonlinear element has a 4-punch in column 80, to give its power and energy consumption.

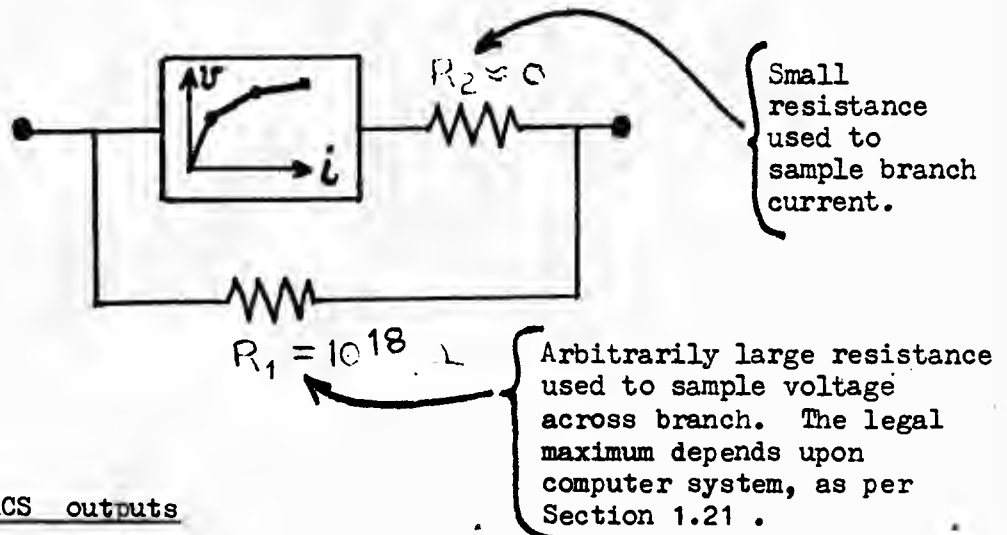

Synchronous machine and TACS outputs

In all, there are five general groupings of output variables for EMTP printed output of the time-step loop. The just-described node voltages come first, then branch voltages come second, and branch currents come third. Then come two additional classes of EMTP output variables: synchronous machine output variables follow as a fourth grouping, and TACS output quantities represent a fifth and final grouping.

Output requests for synchronous machine variables are part of the synchronous machine input data (see Section 1.62, Class 5 data). Variables are identified by a pair of 6-character alphanumeric identifying names for each quantity; these are generated internally, as explained in the just-cited reference. For plotting purposes, the user treats synchronous machine variables as though they were branch currents, though (using a "9" in column 3 of batch-mode plot cards).

A comparable statement to that just made for synchronous machines could also be made for the universal machine (U.M.) of Section 1.63.

Output requests for TACS variables are part of the TACS input data which immediately follows the EMTP miscellaneous data cards and their extensions. See Section 8.5.6 for details. One 6-character alphanumeric name identifies the desired TACS variable, of course. But a name-pair is used for the variable identification, with the TACS name being the second name of this pair. The first name "TACS" is automatically supplied internally by the EMTP. For example, "TIMEX" is the name of the built-in variable which carries the current simulation time; for output purposes, the pair of names "TACS" and "TIMEX" would be used, then. For plotting purposes, the user treats TACS variables as though they were branch currents (using a "9" in column 3 of batch-mode plot cards).

The following sample of EMTF line printer output for the beginning of the time-step loop illustrates the five classes of output variables just described. Since there was no TACS representation, the fifth class or grouping is empty, note:

```
CARD OF BUS NAMES FOR NODE-VOLTAGE OUTPUT.      I NAVH ANAVH BNAVH C
BLANK CARD ENDING NODE NAMES FOR VOLTAGE OUTPUT.  I

COLUMN HEADINGS FOR THE 16 EMTF OUTPUT VARIABLES FOLLOW.  THESE ARE ORDERED ACCORDING TO THE FIVE
POSSIBLE EMTF OUTPUT-VARIABLE CLASSES, AS FOLLOWS ....
FIRST 3 OUTPUT VARIABLES ARE ELECTRIC-NETWORK NODE VOLTAGES (WITH RESPECT TO LOCAL GROUND);
NEXT 3 OUTPUT VARIABLES ARE BRANCH VOLTAGES (VOLTAGE OF UPPER NODE MINUS VOLTAGE OF LOWER NODE);
NEXT 3 OUTPUT VARIABLES ARE BRANCH CURRENTS (FLOWING FROM THE UPPER EMTF NODE TO THE LOWER);
NEXT 7 OUTPUT VARIABLES PERTAIN TO DYNAMIC SYNCHRONOUS MACHINES, WITH NAMES GENERATED INTERNALLY;
FINAL 0 OUTPUT VARIABLES BELONG TO "TACS". (NOTE INTERNALLY-ADDED UPPER NAME OF PAIR).
BRANCH POWER CONSUMPTION (POWER FLOW, IF A SWITCH) IS TREATED LIKE A BRANCH VOLTAGE FOR THIS GROUPING;
BRANCH ENERGY CONSUMPTION (ENERGY FLOW, IF A SWITCH) IS TREATED LIKE A BRANCH CURRENT FOR THIS GROUPING.
```

STEP	TIME	NAVH A	NAVH B	NAVH C	MCC1 A MCC2 A	MCC1 B MCC2 B	MCC1 C MCC2 C	GEN A NAVL A	GEN B NAVL B	GEN C NAVL C
***		MACH 1 TQ GEN	MACH 1 VEL 5	MACH 1 TQS 12	MACH 1 TQS 23	MACH 1 TQS 34	MACH 1 TQS 45	MACH 1 TQS 56		
***						SWITCH *GEN A* TO *NAVL A* CLOSED AFTER -.10000E+01 SEC.				
***						SWITCH *GEN B* TO *NAVL B* CLOSED AFTER -.10000E+01 SEC.				
***						SWITCH *GEN C* TO *NAVL C* CLOSED AFTER -.10000E+01 SEC.				
***						SWITCH *SWT A* TO " " CLOSED AFTER -.0 SEC.				
***						SWITCH *SWT B* TO " " CLOSED AFTER -.0 SEC.				
***						SWITCH *SWT C* TO " " CLOSED AFTER -.0 SEC.				
0	.000000	.541213E+05	-.384968E+06	.330847E+06	-.180363E+06	.106519E+06	.538438E+05	.0	.0	.0
		.900010E+00	.0	.270885E+00	.505652E+00	.704301E+00	.902950E+00	.294055E-02		

1.8b Output-Variable Specification for "STATISTICS" or "SYSTEMATIC" Data Case

General Introduction

A "STATISTICS" or "SYSTEMATIC" overvoltage study is distinct from all other EMTF data cases in that multiple simulations are automatically generated internally by the EMTF. Integer miscellaneous data parameter "NENERG" (see Section 1.0h) defines the number of energizations which are to be simulated. Each energization gives a different solution, due to differences in the closing times for "STATISTICS" or "SYSTEMATIC" switches (see Section 1.40, Class 3A or 3B switch cards). For each energization, only the vector of variable maxima is available for printing, and a statistical tabulation of all $|NENERG|$ such vectors is automatically provided at the conclusion of all such internally-generated simulations. This is the statistical overvoltage output — line printer output which occurs for either "STATISTICS" or "SYSTEMATIC" data cases. There is no associated plotting (unlike conventional cases, where printing and plotting go together). It is the purpose of the present section to explain how the user requests such overvoltage output, and what the printout looks like.

But before describing the output specification cards for the statistical overvoltage tabulation, it should be mentioned that there also is a base-case solution which precedes the $|NENERG|$ energizations. For a "STATISTICS" data case, this is a zero-th energization which is made with all variances temporarily set to zero. For a "SYSTEMATIC" data case, either all beginning or all mid-closing times of the switches are used — whichever the user has chosen to input (see Section 1.40, Class 3B switch cards). Before appending the requests for statistical overvoltage tabulations, the user must complete the data deck for the base case, pretending that it is a separate conventional simulation. The overall (total) data structure thus has the following components and ordering:

- * EMTF source cards, terminated by a blank card.
- * Node-voltage output specification card or cards, applicable to the base case and statistical tabulation. See the beginning of the present section for an explanation of the format. If node voltages are selectively requested, this data will be terminated by a blank card. These cards are required even the "OMIT BASE CASE" option of running statistics case is used.
- * Batch-mode plot-specification cards, applicable to the base case solution only. These are terminated by a blank card. The plot cards must be omitted for "OMIT BASE CASE" option and a blank card is all it needs.
- * Optional misc. statistics data card.
- * Output scaling specification cards for purposes of statistical tabulation, terminated by a blank card.

It now only remains for us to describe the final two of these items:

- (1) Optional misc. statistics data card with "MISC. STATISTICS DATA" punched in columns 41 to 61.

25	26	27	28	29	30	31	32	33	34	35	36	37	38	39	40	41	42	43	44	45	46	47	48	49	50	51	52	53	54	55	56	57	58	59	60	61			
F8.0											F8.0											MISC. STATISTICS DATA																	
AINCR											XMAXMX																												

The purpose of this optional card is twofold. First, for overriding values of AINCR and/or XMAXMX on the original statistics misc. data card (see explanation on pp. 5 - 5c-2). Second, AINCR can be inputted as a negative integer -N: this means that the statistical variables inputted on the following output scaling cards are to be tabulated within N compartments. Any number, if any, of these cards can be inputted and values of AINCR and XMAXMX are effective until overridden by another such card.

- (2) Output scaling specification cards:

IBROPT	Base Value	Network node names for output specification										
	BASE	BUS1	BUS2	BUS3	BUS4	BUS5	BUS6	BUS7	BUS8	BUS9	BUS10	BUS11
12	E12.0	A6	A6	A6	A6	A6	A6	A6	A6	A6	A6	A6

IBROPT ----- Type code for this output-specification card, telling the type of variables in question:

- 0 = This card is for node-voltage specifications.
- 1 = This card is for branch voltage specifications.
- 2 = This card is for branch current specifications.
- 3 = This card is for power specifications.
- 4 = This card is for energy specifications.

BASE ----- Base value which is to be used for the per unit statistical tabulation of all variables which are specified on this data card. The units of base value for a given type of variable should be the same as that of the variables on the card. If AINCR is positive, a blank or zero punch for BASE is given the following default values:

a) If IBROPT is 0 or -1, the default value is equal to the voltage which the EMTP read from the user's first source card, assuming it was a type-14 sinusoidal voltage source. See Section 1.6, field "AMPLITUDE" of columns 11-20 of the source card.

b) The default value is 1 if IBROPT is -2, -3 or -4. However, if AINCR is a negative value, the field of BASE is ignored. The minimum value of the solutions for a given variable is then chosen to be the base value for the tabulation of that variable.

BUS1

----- Node names of the user's network, each A6 alphanumeric information, which specify the desired output variable for the statistical study. There are two distinct cases, depending on the value of 'IBROPT':

BUS10

BUS11

- a) If IBROPT = 0, the variable in question are node names which are to have node-voltage (to ground) output. Blank fields are ignored.
- b) If IBROPT is not equal 0, taken in pairs the variables in question are the node names which specify the branch voltages, branch current, power or energy consumed in the branch. The final field "BUS11" is totally ignored, since the specification of node pairs takes an even number of fields. A pair of two blank fields is ignored.

If there are more than 11 node voltage output variables or more than 5 branch output variables for a given base value, continuation to 5 more cards is allowed. To do this, the user should punch "CONT." in columns 76-80 on the output scaling specification card which to be continued. The continuation cards use the same format except the fields "IBROPT" and "BASE" can be left blank.

There are no ordering restrictions on such "STATISTICS" output scaling specification cards, among themselves. Their end is signaled to the EMTP by a blank card. Statistical tabulations for output variables will occur in the order that the specifications are encountered on these input cards.

Illustrative example of data input

```

-1 100.      GENA  A1
-1          GENC  C1  ENDA  A10
          ASW10 BSW10 CSW10
                        -20.      MISC. STATISTICS DATA
-3          B1    BSW1
-2  0.      GENB  B1  ENDA  A10
-4  0.      B1    BSW1

```

- (1) Branch voltage between nodes "GENA " and "A1 " at base value of 100 volts is requested.

- (2) Two branch voltages are requested: between nodes "GENC " and "C1 ", "ENDA " and "A10 ". The base value for the output tabulation for these two branch voltages is blank, which means the "AMPLITUDE" inputted on the first type-14 sinusoidal voltage source is to be used as the base value.
- (3) Node voltages output have been requested for nodes "ASW10 ", "BSW10 " and "CSW10 " with default base value same as the one described in (2).
- (4) Here is an optional misc. statistics data card on which AINCR = -20. and XMAXMX = blank. This means XMAXMX takes the same value as inputted on the first "STATISTICS" misc. data card at the top of the data case. negative 20 for AINCR means that 20 compartments will be used for tabulating following output variables. These two new values for AINCR and XMAXMX are effective until another such card appears.
- (5) Power flow through the branch connecting nodes "B1 " and "BSW1 " is requested. Since AINCR = -20., the field of base value is ignored. And, 20 compartments will be used for tabulating the results for this power flow, and minimum value among the power flow solutions for this branch is chosen to be the base value.
- (6) Two branch currents are requested: between nodes "GENB " and "B1 ", "ENDA " and "A10 ". Since AINCR is -20., the rule of deciding the base value and compartments for statistical tabulation of these two branch currents is the same as described in (5).
- (7) Energy consumed in the branch connecting nodes "B1 " and "BSW1 " is requested. Again, since AINCR is a negative integer number, the rule for tabulation is the same as in (5).

Explanation of "STATISTICS" printed output

The EMTF printed outputs which are available to the architect of a statistical overvoltage study include the following:

Output a : Switch closing times for each energization.

Printout of the switch closing times T_{close} is automatically provided if the user punches the statistics miscellaneous data variable "ISW" equal to unity. See Section 1.1a .

Output b : Maximum voltages of each energization.

Printout of the vector of maximum variable values for each energization is automatically provided. This is comparable

to what the user gets by setting miscellaneous data parameter "MAXOUT" (see Section 1.0h) equal to unity for a conventional deterministic simulation. The "reference angle" (see Section 1.40, Class 3) is also automatically provided, as part of this printout.

Output c : Statistical distribution of voltages, currents, powers, and energies

Statistical distributions of maximum output-variable values are automatically provided. These are both one at a time, and also as part of the distribution for the union of all such individual outputs which have the same base value.

Output d : Mini lineprinter plots of switch closing times

For "STATISTICS" data cases only, the end of the statistical tabulation of overvoltage output is signaled by line printer plots of the switch closing times. Each "STATISTICS" switch has such a mini plot, the size of which is always the same : 30 columns wide by 25 lines (of the printer) long. Up to three such plots can be spaced horizontally across the page. Experimental (sample) values are marked by the symbol "A" for the left-hand plot, "B" for the center plot (if any), and "C" for the right-hand plot (if any). The symbol "D" is used for all theoretical distributions (which will be either bell-shaped or vertical straight lines). The order of output of these plots is the same as the order of switch card input. More than one plot is produced horizontally on the page if the following one or two switches have identically the same variance as the first one (which goes on the left). This will normally be the situation for the poles of a 3-phase breaker, and the user will generally want all three graphs to be spaced horizontally across the page. If the user wants otherwise, he can slightly perturb one or more variances (a switch with a variance which differs from the preceding one will be placed below on the left, automatically).

Two illustrations of the printer plots of "Output d" are shown immediately below. Although spaced horizontally, the reader may note that they were not actually printed this way by the computer (since both use the symbol "A").

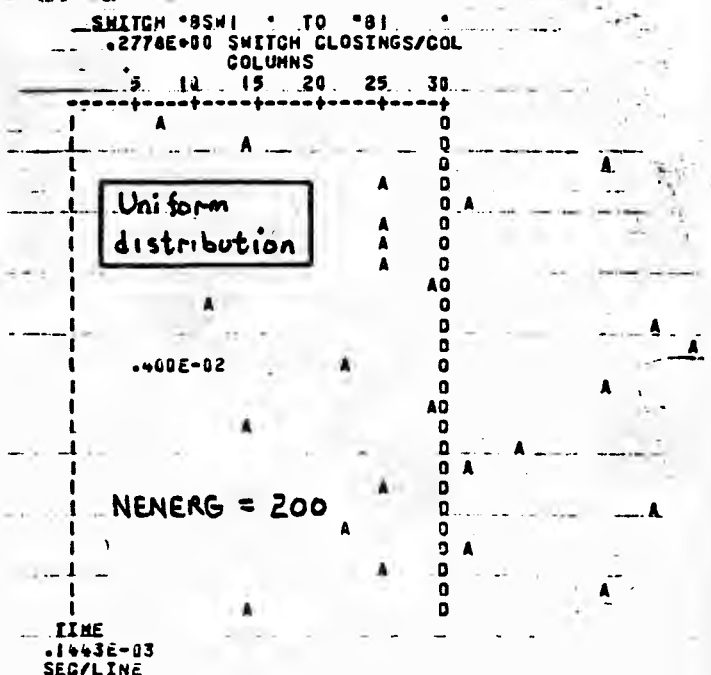
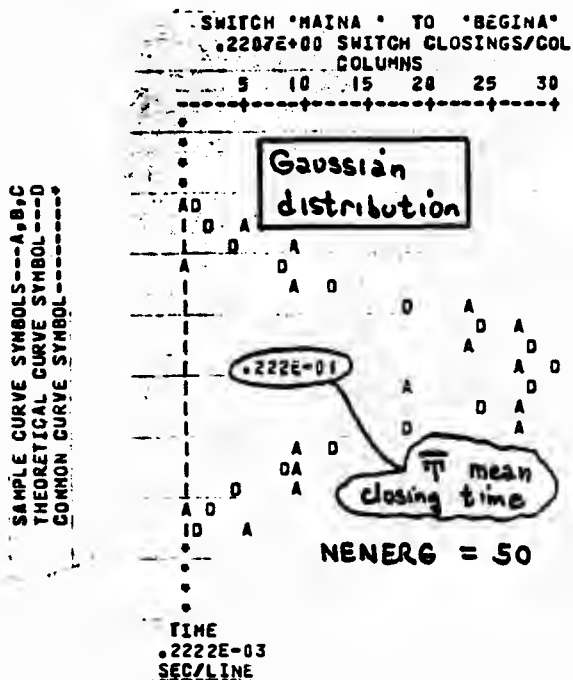

An illustrative sample of "Output a" and "Output b" for a small statistical overvoltage study appears as follows:

THE DATA CASE NOW READY TO BE SOLVED IS A STATISTICAL OVERVOLTAGE STUDY WHICH INVOLVES 5 ENERGIZATIONS (PARAMETER "NENERG" OF COLUMNS 65-72 OF THE 2ND MISC. DATA CARD). CLOSING TIMES FOR THE SPECIALLY-FLAGGED SWITCHES (WITH "STATISTICS" PUNCHED IN COLUMNS 55-64) ARE VARIED RANDOMLY, ACCORDING TO A NORMAL DISTRIBUTION. THE USER CAN SELECT EITHER UNIFORM OR NORMAL DISTRIBUTIONS, BASED ON THE VALUE OF PARAMETER "IDIST" OF COLUMNS 17-24 OF THE SPECIAL STATISTICS MISC. DATA CARD. THE FOLLOWING IS A LISTING OF SWITCHES WHOSE CLOSING TIMES ARE TO BE STATISTICALLY VARIED, ALONG WITH THE ASSOCIATED MEAN AND STANDARD DEVIATION FOR THE DISTRIBUTION, AS REQUESTED BY THE USER.

ENTRY NUMBER	SWITCH NUMBER	FROM BUS	TO BUS	SWITCH CLOSING TIME MEAN (SEC)	"TCLOSE" IN SEC STD. DEVIATION
1	1	ASH1	A1	.002000	.000100
2	2	BSW1	B1	.047000	.001000
3	3	CSW1	C1	.005000	.001000

Of 6 data case switches, those numbered 1, 2, & 3 are "STATISTICS" switches

NOW IN ADDITION TO SWITCH-TIME VARIATION CAUSED BY EACH SWITCH'S OWN DISTRIBUTION, THERE IS THE ADDED RANDOM DELAY WHICH IS THE SAME FOR ALL SWITCHES, REFERRED TO BY THE TERM "REFERENCE ANGLE" DISTRIBUTION FOR THIS ANGLE IS UNIFORM OVER THE TIME INTERVAL FROM -.0 TO 0.36000E+03 DEGREES BASED ON .600E+02 HZ FREQUENCY. THIS WAS ALL SPECIFIED BY THE USER USING FIELDS: "DEGMIN", "DEGMAX", AND "STATFR" (COLS. 41-64) OF THE SPECIAL STATISTICS MISC. DATA CARD. HOWEVER, IF THE PARAMETER "ITEST" (FOUND IN COL. 9-16 OF THE STATISTICS MISC. DATA CARD) IS GREATER THAN ZERO, THE REFERENCE ANGLE IS SET TO ZERO AND, CONSEQUENTLY, THERE IS NO ADDED RANDOM DELAY.

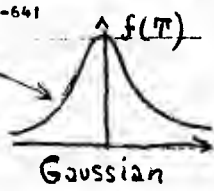

IN THE FOLLOWING PRINTOUT, SWITCH TIMES WHICH ARE USED FOR EACH ENERGIZATION ARE TABULATED, FOLLOWED BY PEAK OUTPUT-VARIABLE VALUES WHICH OCCUR FOR THE ASSOCIATED SIMULATION. FORMAT FOR PEAK VALUES IS IDENTICAL TO THE PRINTOUT FOR MAXIMUM VARIABLE VALUES OF A CONVENTIONAL (I.E., NON-STATISTICAL) STUDY, TO WHICH PRINTOUT OF THE REFERENCE ANGLE IN DEGREES HAS BEEN ADDED AT THE EXTREME LEFT.

Only 2 output quantities, voltage differences, were requested

FIRST 0 RESULTS ARE NODE VOLTAGES (TO LOCAL GROUND).
NEXT 2 RESULTS ARE BRANCH VOLTAGES.

REF. ANGLE	GENA A1	GENB B1	SWITCH CLOSING TIMES FOR ENERGIZATION NUMBER				
.0000	.131475E+03	.160870E+03	1 .206114E-02	2 .457181E-02	3 .678617E-02	4 .800000E-02	5 .100000E-01
			6 .120000E-01				
			SWITCH CLOSING TIMES FOR ENERGIZATION NUMBER				
			1 .190020E-02	2 .332777E-02	3 .481228E-02	4 .800000E-02	5 .100000E-01
			6 .120000E-01				

Two random times from model with $\bar{T} = .006$, $\sigma = .001$

• Etc. for 6 energizations

An illustrative sample of "Output c" for a small statistical overvoltage study of NENERG = 6 energizations appears as follows. Of the several tabulations, only that for node voltage "A5" is shown:

INTERVAL NUMBER	VOLTAGE IN PER UNIT	VOLTAGE IN PHYSICAL UNITS	FREQUENCY (DENSITY)	CUMULATIVE FREQUENCY	PER CENT GE. VOLTAGE
24	1.15000	.348450E+03	0	0	100.000
25	1.20000	.363600E+03	1	1	83.333
26	1.25000	.378750E+03	0	1	83.333
27	1.30000	.393900E+03	0	1	83.333
28	1.35000	.409050E+03	1	2	66.667
29	1.40000	.424200E+03	1	3	50.000
30	1.45000	.439350E+03	0	3	50.000
31	1.50000	.454500E+03	0	3	50.000
32	1.55000	.469650E+03	0	3	50.000
33	1.60000	.484800E+03	0	3	50.000
34	1.65000	.499950E+03	0	3	50.000
35	1.70000	.515100E+03	2	5	16.667
36	1.75000	.530250E+03	1	6	.000

DISTRIBUTION PARAMETERS FOR THE ABOVE DATA.	GROUPED DATA	UNGROUPED DATA
MEAN =	1.516667	1.5378122
VARIANCE =	.052667	.0525309
STD DEVIATION =	.2294922	.2291963

sample variance,

$$\bar{\sigma}_v^2 = \sum_{j=1}^N (V_j - \bar{V})^2 / (N-1)$$

$$\bar{\sigma}_v = \sqrt{\bar{\sigma}_v^2}$$

sample mean, $(\sum_{j=1}^N V_j) / N = \bar{V}$
 where V_j is the peak voltage at node "A5" during solution of energization "j".

Note: The "ungrouped" statistics are calculated using exact solution maxima, while the "grouped" statistics are calculated using discretized, compartmentalized values (rounded to multiples of .05).

1.9 USER SPECIFICATION OF SOURCE FUNCTIONS $f(t)$ FOR TYPE 1-10 SOURCES

1.9a. Introduction

Section 1.6 indicated that source types 1 through 10 are reserved for functions which the user wants to define himself, functions which are not provided for by the sources of type-code 11 onward. The user can resort to any of the following three procedures for defining his unorthodox sources:

Procedure 1 : Define the source functions $f(t)$ empirically at every time step that it is to be nonzero, and punch such points on data cards which then become part of the EMTP data case. Details are given in Section 1.9b below.

Procedure 2 : Define one or more source functions $f(t)$ to equal a TACS variable value. See Section 1.0g2 .

Procedure 3 : Define one or more source functions $f(t)$ analytically, and develop the FORTRAN logic which will return the desired value for any given input time. This becomes the user's own special subroutine "ANALYT", for which he is responsible. The user must replace the original dummy EMTP module of this same name by his own module, before executing the data case in question. A special request card reading "ANALYTIC SOURCES" is also required (see Section 1.0g1).

Details of these procedures shall be elaborated upon below. Yet, if the user is employing the "ANALYTIC SOURCES" feature for the first time, he should definitely talk with Program Maintenance before proceeding too far. Reference to Section 0.5 might also be helpful, since details of how the user will perform his module replacement are definitely a function of the computer system being used.

1.9b Definition of $f(t)$ empirically, at every time step (Procedure 1)

If the user is willing to numerically punch his desired source values $f(t)$ on cards for every time step, then, the following is the procedure that he is to follow. See Section 1. for correct position of these data cards within the data case in question.

RULES:

- 1) The values of the curves $f(t)$ at $t = \Delta t, 2 \Delta t, 3 \Delta t, \dots$ must be supplied in the correct time order with one card for each time step. Note that the first card is for $t = \Delta t$ (not $t = 0$, which belongs to the initial conditions).

Format for empirically specifying source types 1-10							
type 1	type 2	type 3	type 4	type 5	type 6	type 7	Etc...
E8.0	E8.0	E8.0	E8.0	E8.0	E8.0	E8.0	

- 2) If all 10 source functions become zero prior to $t = t_{max}$, then punch "9999" in col. 5-8 on that card where they are all zero for the first time. Then the functions in that and all subsequent time steps will be regarded as zero. No more cards must follow the 9999 - card.

- 3) If at least one of the source functions in the 10 fields is non-zero all the way to t_{\max} , then a stack of exactly n cards with no blank card for termination must be supplied, where:

$$n = \frac{t_{\max}}{\Delta t}, \text{ rounded to nearest integer.}$$

Examples: $t_{\max} = 0.0105, \Delta t = 0.005 \quad n = 2$
 $t_{\max} = 0.0130, \Delta t = 0.005 \quad n = 3$
 $t_{\max} = 0.0098, \Delta t = 0.005 \quad n = 2$

1.9c Definition of One or More Source Functions $f(t)$ Analytically (Procedure 3)

Either as an alternative to, or as a supplement to, the representation of Section 1.9b, the user is permitted to define one or more of the ten possible source functions $f(t)$ in FORTRAN, within subroutine "ANALYT". Relevant rules and restrictions related thereto include the following:

Rule 4: Begin the data case with an "ANALYTIC SOURCES USAGE" data card (see Section 1.0g1). To appear before the miscellaneous data cards, this record tells the EMTF to employ subroutine "ANALYT" of Rule 5.

Rule 5: In FORTRAN, the user must write the computer code of subroutine "ANALYT" which defines the one or more needed functions for any time value t . Comment cards within the dummy UTPF module which is to be replaced by the user document the interface requirements:

```

M12. 530  SUBROUTINE ANALYT
M15.1319C) THIS MODULE IS CALLED BY SUBROUTINE "SUBTS3" OF OVERLAY 16
M15.1320C) (OVERLAY 18 IF ECS OVERLAYING IS USED ON CDC) IF AND ONLY IF THE
M15.1321C) DATA CASE BEING SOLVED USES ONE OR MORE SOURCES OF TYPE 1 THROUGH
M15.1322C) 10, AND ALSO HAS A SPECIAL "ANALYTIC SOURCES" REQUEST CARD
M15.1323C) WHICH PRECEDES THE MISCELLANEOUS DATA CARDS. IF THIS BE THE
M15.1324C) CASE, THE USER MUST REPLACE THIS DUMMY MODULE WITH ONE WHICH PUTS
M15.1325C) ONE OR MORE SOURCE VALUES IN VECTOR "VOLT" AT EACH TIME STEP.
M12. 538C) RELEVANT VARIABLES TO USE IN THIS DEFINITION PROCESS ARE .....
M12. 539C) T ----- TIME IN SECONDS FOR WHICH SOURCE VALUES MUST BE
M12. 540C) ASSIGNED;
M12. 541C) ISTEP ----- THE TIME-STEP NUMBER.
M12. 542C) DELTAT ----- THE TIME-STEP SIZE. A CONSTRAINT AMONG THESE
M12. 543C) THREE VARIABLES IS T = ISTEP*DELTAT.
M12. 544C) VOLT ----- VECTOR OF SOURCE VALUES. FOR THE SOURCE HAVING
M12. 545C) TYPE-CODE "L", VOLT(L) MUST BE ASSIGNED
M12. 546C) TO EQUAL THE DESIRED SOURCE VALUE AT TIME "T".
M12. 547C) SINCE THE PRESENT DUMMY MODULE MHO BETTER NEVER BE CALLED, THE
M12. 548C) FOLLOWING STATEMENTS WILL KILL THE RUN WITH AN APPROPRIATE ERROR
M14.2604C) MESSAGE. THE ONE EXCEPTION IS FOR UTPF TEST CASE NUMBER 14,
M14.2605C) WHICH HAS NTOT = 5, IBR = 5, AND DELTAT = 0.1.
M12. 551  INSERT DECK BLKCOM
M12. 552  IF ( NTOT .NE. 5 ) GO TO 8613
M14.2606  IF ( IBR .NE. 5 ) GO TO 8613
M14.2607  D1 = (DELTAT - 1.0/10.) * 100.
M18. 837  IF ( ABSZ(D1) .GT. TENM3 ) GO TO 8613
M12. 556  IF ( VOLT(2) .NE. 0.0 ) GO TO 2416
M12. 557  D1 = T - 0.25
M12. 558  VOLT(2) = 100. - 100.*D1
M12. 559  IF ( T .GT. 0.75 ) VOLT(2) = 0.0
M12. 560 2416 RETURN
M12. 561 8613 KILL = 101
M12. 562 LSTAT(19) = 8613
M12. 563 RETURN
M12. 564 ENO

```

For nearly all computer systems of interest, the user can save quantities from one time step to the next in storage which is local to "ANALYT", even though the integrity of such storage is not guaranteed by new ANSI 77 FORTRAN rules, I am told. If there is any question on this point, consult with a FORTRAN expert for the computer system of interest.

Rule 6 : Any function definitions $f(t)$ within subroutine "ANALYT" are applied by the EMTP after the empirical definitions of Section 1.9b, thereby overriding such empirical definitions. It is this sequencing which shows how and why it is possible to use a combination of the two definition procedures:

- a) Always, when using the "ANALYTIC SOURCES USAGE" option, data cards of Section 1.9b must be supplied. If no functions $f(t)$ are to be so defined empirically, then it is just the single 9999-card which is required.
- b) Upon the call to subroutine "ANALYT", vector VOLT(10) will contain values as they were read from the ten source fields of the Section 1.9b empirical source-definition data cards. Or, if the terminating 9999-card has already been read, VOLT(10) will be identical zero. These input values for vector VOLT(10) can of course be used in the logic of subroutine "ANALYT", if desired.

1.9d Sample Illustrative Usage of Analytic Type 1-10 Source Definition

Suppose that the following two sources are desired, as part of some particular EMTP data case:

Source 1 : A voltage source $v(t)$ which is defined empirically (point by point), except that when such values are found to be non-positive, the following alternative assignment applies:

$$v(t) = \max \left\{ \begin{array}{l} -3.6 \\ -5.4 \cos^2(120\pi t + 60^\circ) \end{array} \right\}$$

Source 2 : A sinusoidal voltage source, where the phase angle varies periodically, cyclically. Such might not be an unreasonable first approximation for a generator which is "swinging" in the transient stability sense, due to a system disturbance. Suppose we want:

$$\begin{aligned} v(t) &= 303000 \cdot \cos(120\pi t + \delta(t)) \\ \delta(t) &= 30^\circ + 10^\circ \cdot \cos(5t + 90^\circ) \end{aligned}$$

The user can supply any number (from zero on up) of data cards defining source number 1 empirically, terminated by a 9999-card if such definitions do not extend through the final time step. The following subroutine "ANALYT" will then complete the job of defining the two desired sources:

SUBROUTINE ANALYT

Insert the current EMTP /BLANK/ here. On CDC, this just takes the single record *CALL, BLKCOM ; on Univac, the single record INCLUDE BLKCOM suffices. Other systems may require the full set of 50 or so records. Don't forget appropriate variable type specifications, if any (such as IMPLICIT REAL*8 for IBM, generally).

```

IF ( VOLT(1) .GT. 0.0 ) GO TO 1492
D1 = TWOPI * ( 60. * T + 1./6. )
D1 = -5.4 * COS(D1) **2
IF ( -3.6 .GT. D1 ) D1 = -3.6
VOLT(1) = D1
1492 D1 = COS( 5.0*T + TWOPI/4.0 )
D1 = 30. + 10.*D1
D1 = TWOPI * ( 60.*T + D1 / 360. )
VOLT(2) = 303000. * COS ( D1 )
RETURN
END

```

1.9e Definition of Type 1-10 EMTP Sources using TACS (Procedure 2)

Procedure 2 (the use of TACS) for the definition of Type 1-10 EMTP sources is straight forward. The user must of course define whatever TACS dynamics he desires, as explained in the TACS data instructions of Section 8. He also must indicate which source is to be controlled by which TACS variable, using a "TACS EMTP SOURCES" card of Section 1.0g2 .

That's all there is to it.

Note about hierarchy of procedures

The three procedures which have been described above are applied to Type 1-10 sources in the order that they are numbered. That is, Procedure 1 first, etc. :

- 1) First a data card is read, if it exists (if the bounding flag "9999" has not yet been encountered); all ten source values are defined therefrom.
- 2) Next, any "TACS EMTP SOURCES" definitions will over-ride the Procedure 1 assignments for those sources.
- 3) Finally, module "ANALYT" (if user-supplied and active) will modify the result of the preceding step in a way which is known only to the user. Note that further analytical processing of TACS dynamics is in this way possible, before the values actually are applied to the Type 1-10 EMTP sources.

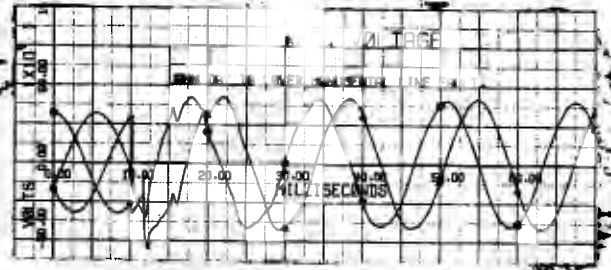

1.10 CARDS FOR BATCH-MODE PLOTTING

Cards of this type are required for the input of additional data associated with the plotting of EMTP solution variables as functions of time. This is batch-mode plotting, with results available either on the computer-driven X-Y plotter (Calcomp plotter), or on the line printer (printer plotting). Interactive CRT plotting is done separately from the EMTP data-case setup, so is not described here (see Section 5.0).

A. General Rules and Procedures Concerning Batch-Mode Plotting

Rule 1 : Variables are available for plotting only if they have been previously requested for output as per Section 1.8 .

Rule 2 : Any number of plots can be made from any one solved data case. Up to four curves per plot are permitted. Only curves of the same type (among the five different classes : node voltage, branch voltage, branch current, branch power, branch energy) can generally be plotted on the same graph.

Rule 3 : Three graphing modes are available for batch-mode plotting, as the user is assembling his card deck of plot requests:

- a) A graph just on the Calcomp pen-and-ink plotter. This will be referred to hereafter as the "CALCOMP PLOT" mode of operation, after the special request card bearing this text. See Section 1.10-B-9 .
- b) A graph just on the line printer. This will be referred to hereafter as the "PRINTER PLOT" mode of operation, after the special request card bearing this text.
- c) The same graph on both the Calcomp plotter and the line printer. This will be referred to hereafter as the "CALCOMP PRINTER" mode of operation, after the special request card bearing this text.

The user is free to switch back and forth among these three modes, during the course of his plot requests (see Section 1.10-B-9). "CALCOMP PLOT" is of course the most accurate and the nicest, while "PRINTER PLOT" is generally the least demanding of computer job time (not to mention the much faster actual plot time).

Rule 4 : Branch or switch current, power, or energy plots for two or more elements which are connected in parallel are not possible at the present time. As plot branches are identified only by terminal node-pair names, the program will always pick the first of the two or more qualifying candidates which it finds in the output vector. Refer to Section 1.8-A for a remedy, should this restriction bother the user.

Rule 5 : There is no limit on the number of data points which go into the production of each plot. If the array into which the data is read should become filled, and more data is needed, logical unit number 9 (the disk) is used for overflow storage.

Rule 6 : There are 13 different types of cards which may be used in requesting batch-mode graphs from the EMTF; the plot cards as a group or class of data will generally consist of a controlled mixture of these types:

1. Card bearing 78-character case title text.
2. Cards bearing graph subheading text.
3. Plot specification card.
4. Card for specification of 3 or 4 branch node-pair names (special request word "BRANCH").
5. Card for extended precision of floating-point fields (special request by zero time-scale).
6. Card for Calcomp graph-size adjustment (special request word "HEIGHT").
7. Card for Calcomp graph-separation adjustment (special request word "MARGIN").
8. Card for redefinition of smoothing tolerance ϵ (special request word "SMOOTH").
9. Card for changing the graphing-mode selection (special request words "PRINTER PLOT" , "CALCOMP PLOT" , and "CALCOMP PRINTER").
10. Card for changing the plotter print-head status (special request words "PRINT HEAD OFF" and "PRINT HEAD ON").
11. Card for changing the pens which are used to draw each curve, plus control of the drawing of a grid (special request word "PEN CHOICE").
12. Card for redefinition of line limit for sparse printer plots (special request word "PLOT LINE LIMIT").
13. Card for requesting that two or more plot cards be plotted on the same graph, with possible suppression of vertical-axis labeling (special request word "SUPERIMPOSE").
14. Card for the photographic magnification or reduction of a plot image, with special application to metric plotting (special request word "SCALE").
15. Card to plotting one EMTF variable against another (special request word "X-Y PLOT").
16. Card for switching from plotting to Fourier series (special request word "FOURIER ON").
17. Card for switching from Fourier series to plotting (special request word "FOURIER OFF").
18. Card to mark the termination of all preceding plot cards.

Of the above card types, only the plot specification card of number 3 is actually required to produce a plot; there will be one graph for each such card. A detailed description of the format and precise function of all of these cards will be found in Section 1.10-B, under the numbers which are used above.

Rule 7 : The one to four curves which can appear on the same graph are identified by the following symbols and node names:

Curve number	Printer Plot	Calcomp Plot	Name for node voltage is read from columns:	Node-pair names for branch or switch output (2A6 information) is read from columns:
1	A	⊙	25 - 30	25-36 ~ 1 st node pair
2	B	△	31 - 36	37-48 ~ 2 nd node pair
3	C	+	37 - 42	} Three or more branch quantities require use of special "BRANCH" request.
4	D	X	43 - 48	
Intersection of 2 or more curves	*			

In the upper right hand corner of every plot, there will be a legend which shows the symbol, the curve number, and a sample line drawn by the pen --- for each curve. An illustration for a case with three curves follows:

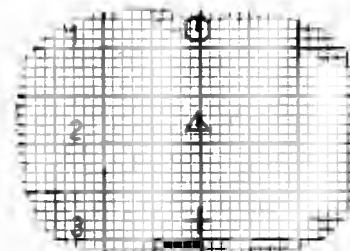

The output frequency of the curve-indication symbols on the Calcomp plots corresponds to every one inch for the unsmoothed (raw) data; larger separations which will generally be observed allow for estimation by the user of what fraction of the data points has been discarded during "smoothing" (see Rule 8 below).

Rule 8 : If a Calcomp plot is to be made, the program first discards those data points which will not visually affect the plot, according to the following algorithm. This is the so-called "smoothing" algorithm:

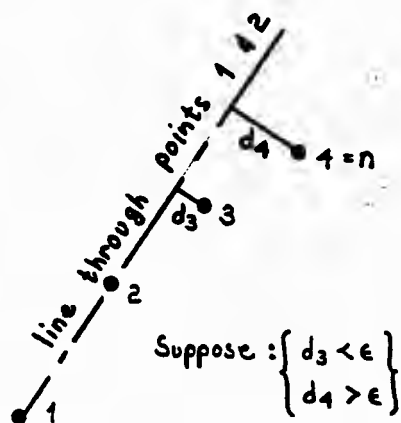

Initial test line

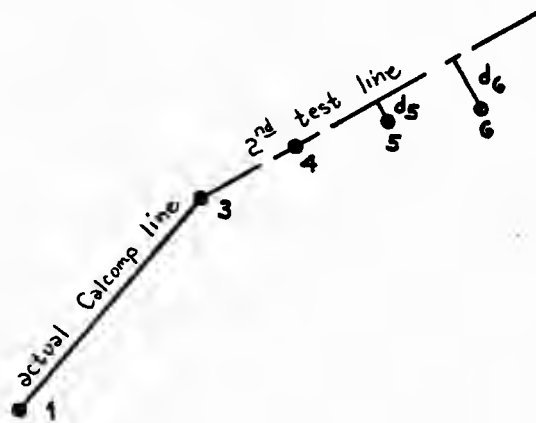

2nd test line after discarding pt. 2.

The first point of raw plot data is always retained, and an imaginary line is drawn from it through the second point of plot data. Starting with the third point, then, the distance d of each succeeding point from the line is calculated, and compared to a smoothing tolerance (see Rule 6, Point 8) ϵ :

- a) As long as $d \leq \epsilon$, the distance calculation is simply repeated for the following point.
- b) Eventually, for some n it is found that the n -th point is further removed than ϵ from the line ($d > \epsilon$). In this case, the $(n-1)$ -st point is saved, and all points between the $(n-1)$ -st point and the last previously-saved point are discarded. This is based on the principle that throwing away such points will not significantly affect the resulting graph visually, since they lie on, or almost on, the line about which the distances were calculated.

Such distance-testing is then continued recursively, following the sample just outlined. It is begun by drawing a new line from the $(n-1)$ -st point through the n -th point, and then checking distances from this new line for points numbered $n+1$ onward.

The one exception to the distance comparison based on ϵ as just described is that pertaining to relative minima or relative maxima; such a point of relative extremum is always saved, regardless of its distance from the line. In effect, $\epsilon = 0$ is used for the calculation at extrema.

The value of smoothing tolerance ϵ is under user control, by means of a special "SMOOTH" request card. Details are covered in Section 1.10-B-8.

Line printer plotting is executed before smoothing occurs. Thus if only this mode of batch-mode plotting is being used (the last request of Rule 6, Point 9 was "PRINTER PLOT"), the entire smoothing process is bypassed, and not executed. But if both modes of plotting are currently activated (the last request of Rule 6, Point 9 was "CALCOMP PRINTER"), the raw data points are first plotted on the line printer, then they are smoothed and plotted on the Calcomp plotter.

Rule 9 : The user has control over whether all plots are to be positioned end-to-end horizontally (down the length of the graph paper), or are also to be lined up vertically as well (as permitted by the paper width). For example, consider the following contrasting situations:

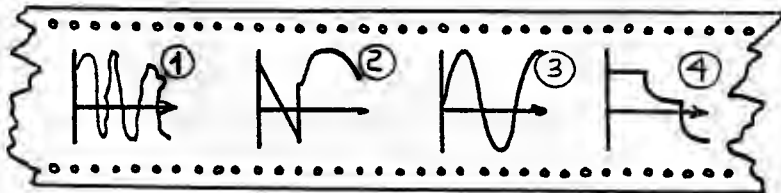

Fig. 1. All plots positioned horizontally.

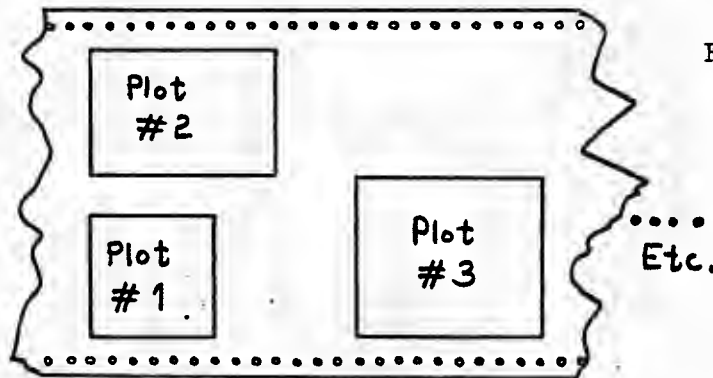

Fig. 2. Plots positioned vertically as well as horizontally.

The general rule as to EMTP batch-mode plotting is as follows: plots are positioned vertically (one on top of the other) until the paper width would be exceeded; then the process begins at the bottom again, to the right of the just-completed plots. The first plot of a new data case automatically begins at the bottom of the paper, too.

User control of this graph-positioning process (vertical stacking) is by means of the following variables:

"SZPLT"	-----	Paper width (height as used here), as described in Section 1.0c .
"BEGIN"	-----	Height of each individual plot, as defined by a "HEIGHT" card. See the description of Section 1.10-B-6 .
"SPAN"		

Recall that default values exist for these, assuming that they are not re-defined by the user. In June of 1977, CDC translations were using 10. , 1.0 , and 8.0 inches for these, respectively. Using these just-stated values would give the horizontal positioning of Fig. 1 above, regardless of the actual width (height) of the plot paper. On the other hand, changing "SZPLT" to 24.0 inches would result in the positioning of two plots vertically as shown in Fig. 2 above ---- again regardless of the actual width of the plot paper. Of course if the actual paper width is less than "SZPLT" , the pen will attempt to move off of the paper (not a very satisfactory situation). It is the user's responsibility to see that the paper is at least as wide as the "SZPLT" value which is being used, then.

- ii) For voltage differences or powers of branches or switches, punch an "8" in column 3.
- iii) For currents or energies of branches or switches, punch a "9" in column 3.
- Remember that dynamic synchronous machine variables are all plotted as though they were branch currents, so they use a "9" punch too.

Col. 4 ----- A code number indicating which units are desired for the time axis. Floating-point time specifications to follow are then assumed to be in these units:

"1" ----	for degrees	} Based on the synchronous power frequency "STATFR" (see Section 1.0c for redefinition).
"2" ----	for cycles	
"3" ----	for seconds	
"4" ----	for milliseconds	
"5" ----	for microseconds	
"6" ----	for frequency in Hertz	
"7" ----	for the base-ten logarithm of "6"	

Note: "6" and "7" are applicable to Bode plots only ---- the plotting of phasor solutions in the frequency domain only. See Section 1.0g3 .

Cols. 5-7 ----- The desired horizontal scale "HPI" in time units (whatever they may be, from the col. 4 request) per inch.

For example, if the user punches "3.0" in columns 5-7, and "4" in column 4, then he will get a time axis with scaling 3.0 msec/inch .

A blank or zero field has special significance, as a request for extended floating-point precision for plot-card input fields (see Section 1.10-B-1).

Cols. 8-11 ----- The beginning time "HMIN" where the time axis will start, in units of whatever the user has selected by his column-4 punch.

Cols. 12-15 ----- The final time "HMAX" where the time axis will end, in units of whatever the user has selected by his column-4 punch.

The curves will be plotted from the left graph limit "HMIN" to the right graph limit "HMAX" only; these limits themselves will generally lie somewhere in the study time-range of zero to "TMAX" (floating-point miscellaneous data parameter; see Section 1.0h) seconds.

- Cols. 16-20 ----- Value at bottom of vertical axis, "VMIN" .
This is the minimum ordinate on the scale.
Leave blank if automatic scaling is desired.
- Cols. 21-24 ----- Value at top of vertical axis, "VMAX" .
This is the maximum ordinate on the scale.
Leave blank if automatic scaling is desired.

Further comments about "VMIN" and "VMAX"

Parameters "VMIN" and "VMAX" only have meaning for plotting on the Calcomp plotter, since line printer plots are always automatically scaled so as to utilize the full 132 characters of carriage width.

In cases where the minimum and maximum values of the one or more curves for a given Calcomp graph are not known in advance, it is usually convenient to let the EMTP decide upon the appropriate vertical scaling. This is requested by leaving fields "VMIN" and "VMAX" blank.

In order for the "tic" marks on the vertical axis of a Calcomp plot to correspond to nice round numbers, the variable span of that axis (VMAX - VMIN) should be divisible evenly by the axis length in inches. The axis length is under user control (see Section 1.10-B-6), although it is normally left at its installation-dependent default value (typically 8.0 inches; see Section 0.5).

- Cols. 25-30 } ----- Network node names are read from the four A6
31-36 } fields which are contained in the columns 25-48.
37-42 } These identify the curves to be plotted, as
43-48 } follows:
- i) For node-voltage plots, the name or names of the nodes in question are to be punched. Any of the four name-fields can be left blank, if not needed.
 - ii) For branch or switch variables (element voltage difference, current, power, or energy), punch either one or two node-pair names which identify the branches in question. Columns 25-36 are for one branch, and columns 37-48 for another.

If more than two branch or switch variables are desired on the same graph, the user should punch the special request word "BRANCH" in cols. 25-30; then the EMTP will read the node-pair names for up to four elements from a following card, as detailed in Section 1.10-B-4.

Cols. 49-64 ----- 16 arbitrary alphanumeric characters, to be used as the main graph heading label. On the Calcomp, this will be drawn with letters 0.20 inches in height.

Cols. 65-80 ----- 16 arbitrary alphanumeric characters, to be used to label the vertical axis of the graph.

Point 4 : Card for input of 3 or 4 branch-variable names

If the special request word "BRANCH" is punched in columns 25-30 of the plot specification card (Point 3), then the variable identification is not made using columns 25-48 as usual; instead, the EMTP will read such information from an additional card which immediately follows, where up to four node-pair variable identifications are to be provided:

I1	NCRV	3	25	26	27	28	29	30	31	32	33	34	35	36	37	38	39	40	41	42	43	44	45	46	47	48	49	50	51	52	53	54	55	56	57	58	59	60	61	62	63	64	65	66	67	68	69	70	71	72
				1 st branch				2 nd branch				3 rd branch				4 th branch																																			
				BUS1				BUS2				BUS3				BUS4				BUS5				BUS6				BUS7				BUS8																			
AG				AG				AG				AG				AG				AG				AG				AG																							

NCRV ----- Leave blank if all curves are to be plotted on the same graph.

A nonzero integer between 1 and 4 will be taken to mean the number of curves on the same graph. Such usage is rare.

BUS1, BUS2 ----- node-pair names for the first branch or switch which is to have its variable plotted on the graph.

BUS3, BUS4 }
 BUS5, BUS6 } ---- Similar meanings for the 2nd, 3rd, and 4th branches
 BUS7, BUS8 }

If any one of the four node-pair identifications contains two blank words (12 blank characters), the request is simply ignored.

Point 5 : Card for extended precision of floating-point fields

The five floating-point fields of the plot specification card, "HPI", "HMIN", "HMAX", "VMIN", and "VMAX", all vary in width from three to five columns. Now, this is generally sufficient for typical production usage, in which nice round numbers such as 20.0 msec/inch for the horizontal axis scaling are typical. But the precise scaling of odd-ball tolerances such as 16-2/3 msec/inch is clearly impossible using such limited-precision fields for data input. The option described below removes this limitation.

For full 16-column-width precision in the specification of all five floating point plot-specification card parameters, the user need only leave columns 5-7 (field "HPI") of the plot-specification card blank. The program will then read an additional following card, from which it will extract the five variables in question, in the same order, using the following format:

HPI	HMIN	HMAX	VMIN	VMAX
E16.0	E16.0	E16.0	E16.0	E16.0

Exception : For a situation where the user desires to use both the "BRANCH" option of Point 4 and also the option just described, it is the present extended-precision card which is to be deferred:

1. Plot specification card with blank cols. 5-7, and "BRANCH" punched in columns 25-30.
2. Then the branch-variable name card of Point 4.
3. Then (finally) the extended-precision card immediately above.

Point 6 : Card for Calcomp graph-size adjustment

The bottom margin and vertical-axis height of a Calcomp plot are installation dependent, though typically set to default values of 1.0 inch and 8.0 inches, respectively. Either or both of these parameters can be changed by the user, as per a special request card having the following format:

ITYPE	BEGIN	SPAN	Special request word
1	E4.0	E4.0	HEIGHT

Cols. 1-2 ----- "ITYPE" , the card type-code is to be punched as unity.

Cols. 8-11 ----- "BEGIN" , the new lower margin in inches, read using E4.0 format.

Cols. 12-15 ----- "SPAN" , the new graph height (vertical axis span) in inches, read using E4.0 format.

Cols. 25-30 ----- The special 6-character request word "HEIGHT" .

All plots requested after input of this card will have this specified bottom margin and vertical-axis height, unless subsequently changed by another such card at a later stage of the plot-data input cards.

It might be mentioned that implicit to this discussion is the assumption that the operator will start the Calcomp plotter with the pen origin at the bottom of the graph paper; if not, the lower margin is simply relative to whatever point the operator initializes the origin at.

If the total distance represented by bottom margin "BEGIN" plus vertical axis height "SPAN" is greater than the installation-dependent plot-paper size "SZPLT", a message is printed on the line printer and the graph size-adjustment request in question is ignored by the EMTP. In this case, the program would continue to use the last legal values for "BEGIN" and "SPAN" ---- either those originally set by default, or defined on a previous graph-size adjustment card. In this discussion, variable "SZPLT" is the total width of the plotting paper, the value for which is under user control as per Section 1.0c .

Line printer plotting is completely unaffected by the presence or absence of such a graph-size adjustment card (since it only applies to the Calcomp).

Point 7 : Card for Calcomp graph-separation adjustment

The spacing between successive Calcomp plots is initially set by the program at the start of each new data case to an installation-dependent value of "KSEP" inches (an integer; usually equal to 2 inches). But such graph separation can be altered by the user at any stage of the plotting, by means of a card having the following format:

ITYPE	KSEP	MARGIN
1	11	

Cols. 1-2 ----- "ITYPE", the card type-code is to be punched as unity.

Col. 4 ----- "KSEP", the inter-graph separation distance which is desired, as an integer number of inches between 2 and 9, inclusive.

Cols. 25-30 ----- The special 6-character request word "MARGIN".

The inter-graph separation which is requested in this way will continue in effect for all Calcomp plots of a given data case until another such "MARGIN" request is encountered. But remember that each data case will automatically be initialized to the default value for "KSEP" at the very beginning; hence such "MARGIN" requests are only local to the data case of which they are a part.

Requested separations "KSEP" of less than 2 inches are rejected by the EMTP, with the preceding legal value (whatever it may have been) simply continuing in effect, in this case. A warning message of such a rejection is outputted to the line printer in such a case, for the user's benefit.

Line printer plotting is completely unaffected by the presence or absence of such a graph-separation adjustment card (since it only applies to the Calcomp).

Cols. 1-2 ----- Blank.

Cols. 3-17 ----- Special request-word text for the desired mode:

"PRINTER PLOT" makes the following plots come out just on the line printer.

"CALCOMP PLOT" makes the following plots come out just on the Calcomp plotter.

"CALCOMP PRINTER" makes the following plots come out on both the line printer and also on the Calcomp plotter.

The EMTP is initialized at the beginning of each new data case to just produce Calcomp plots. This or a later requested mode will remain in effect for the data case in question until changed by another such request card as above.

Point 10 : Card for changing the plotter print-head status

Some pen-and-ink plotters have the option of "typing" all character output using a print-head, rather than drawing such characters using the pen. Of course such lettering and numbering is not generally as pretty, and is of a uniform, small size (typically something like the capitol letters of a typewriter). But use of such a print-head reduces substantially the plotting burden on the computer, so is to be encouraged wherever available, and when aesthetics are not of prime importance.

The EMTP is set by default to begin the graphs of each new data case using the print-head, if it exists. A request for either mode of lettering is then acceptable at any point in the plot data cards for the data case, using the following format:

1	2	3	4	5	6	7	8	9	10	11	12	13	14	15	16	17	18	19	20	21	22	23	24	25	26	27	28	29	30	:															
PRINT HEAD OFF																																													
PRINT HEAD ON																																													

Cols. 1-2 ----- Blank.

Cols. 3-16 ----- Special request-word text for the desired status of the print-head:

"PRINT HEAD OFF" makes the following Calcomp plots having lettering which is drawn by the pen.

"PRINT HEAD ON " makes the following Calcomp plots having lettering which is typed by the print-head, should the hardware capability exist.

The requested print-head status will remain in effect throughout the data case in question until altered by another such request. Line printer plotting is completely unaffected by such print-head status requests, of course.

Point 11 : Card for changing the pens and the grid status

Different curves of any plot may be drawn with different pens, if desired. Common usage is to either vary the boldness of black lines, or else to plot in color (with each curve being a different color). Such a choice of pens can be changed at will by the user ---- from plot to plot, if desired.

The option of a pen-drawn grid for plots is also available. Common usage is for plotting on unruled (blank, pure-white) paper. Grid lines are drawn every inch, both horizontally and vertically, as extensions to the "tic" marks of the axes.

User control of the two preceding options is provided by a single card, which is to have the following format:

PEN CHOICE	I8	I8	I8	I8	I8
	KPGRID	KPEN ₁	KPEN ₂	KPEN ₃	KPEN ₄

- Cols. 3-12 ----- Special request-word text "PEN CHOICE" is punched in this field.
- Cols. 17-24 ----- "KPGRID", the integer pen number (I8 format) which is to be used for drawing the grid. A zero or blank field will suppress the grid (i.e., none will be drawn).
- Cols. 25-32 ----- KPEN(I), the integer pen number (I8 format) which is to be used to draw curve number "I" of the plot. A zero or blank field is taken to mean no change in the pen number (from the preceding assignment) for the curve associated with that data field.
- 33-40
- 41-48
- 49-56

The requested pen choices and grid specification will remain in effect throughout the data case in question, until altered by another such request card.

Before the first appearance of such a card within any data case, the program automatically provides the following initialization:

$$KPGRID = 0 \quad (KPEN(I) = 1 \text{ for all } I)$$

That is, there will be no grid, and all curves will be drawn with pen number 1, unless an explicit request to the contrary follows.

Point 12 : Card for changing line limit on sparse printer plots

For curves where the number of raw plot data points exceeds the number of printed lines of a line printer plot, there is no problem with line limits on printer plots; printer plots can be of any length in this case.

But if the user requests more printed lines of time axis than there are raw plot-data points for that interval, then a special limit "LINLIM" comes into play. Such a "sparse" printer plot will be terminated when this line limit is exceeded.---- where "sparse" is defined to mean that there are fewer raw data points than printed lines. Such sparse plots are characterized visually by lines of plot output which have no curve symbols.

Sparse plot line-limit "LINLIM" has been given a default value of 100 . This limit can be redefined by the user, however, using a special-request card of the following format:

1	2	3	4	5	6	7	8	9	10	11	12	13	14	15	16	17	18	19	20	21	22	23	24	25	26	27	28	29	30	31	32
PLOT LINE LIMIT																		18													
																		LINLIM													

Such a user-requested "LINLIM" will remain in effect throughout the data case in question, until altered by another such request card. A following data case will begin with the default value, however.

Point 13 : Card to superimpose plots and/or suppress vertical-axis labeling

It is not uncommon for the user to desire extensions to the basic plot capability of the Point 3 format. For example, he may want:

- the plotting of more than 4 curves on the same graph, or
- the plotting of different variable types (e.g., node voltages and branch currents) on the same graph, or
- the addition of a vertical offset for one or more curves of a graph, or
- suppression of the vertical-axis labeling (leaving just the vertical line with tic marks).

All of these operations are possible, by careful use of the powerful (but tricky) "SUPERIMPOSE" card.

User control of special features such as those just mentioned is by means of a special-request card having the following general format:

1	2	3	4	5	6	7	8	9	10	11	12	13	14	15	16	17	18	19	20	21	22	23	24	25	26	27	28	29	30	31	32	33	34	35	36	37	38	39	40	41	42	43	44	45	46	47	48
SUPERIMPOSE													18					18					18																								
													MPL1					MPL4					MPL5																								

Columns 3-13 ----- Special-request word "SUPERIMPOSE" is punched in columns 3-13 .

MPL1 (25-32) ----- The integer number of plot specification cards (Point 3) which are to be superimposed. Any non-positive integer (e.g., zero or blank) will be defaulted to unity.

MPL4 (33-40) ----- "vertical offset between curves (see Usage 3)". DVD letter July, 1983

MPL5 ----- A flag for possible suppression of the vertical-axis
(41-48) labeling. If no such labeling is desired, punch a
"1" in column 48 ; otherwise, leave the field
blank, or punch zero.

This "SUPERIMPOSE" feature is very powerful, but also a little tricky. For this reason, it is desirable that the user understand a few basic operational principles, rather than just the plotted effect.

Principle 1 : The superposition feature is based on suppression of the origin-changing operation which normally occurs upon the completion of a plot. If the change of origin is omitted, the following plot will be drawn on top (i.e., superimposed) of the preceding one. Thus the superimposed plots are really separate, independent EMTP plot; they are produced separately, just as would be the case if there were no "SUPERIMPOSE" card.

Principle 2 : All non-curve inking for the second and later of a group of superimposed plots is automatically suppressed. Thus the grid (if requested), the axes, the date and time (etc.), and any title will only be drawn once ---- for the first of the superimposed plots. The scaling of the second and later superimposed plots is not documented on the plot, then, it will be noted.

With this underlying information now in hand, let us consider several cases of novel (but not uncommon) usage:

Usage 1 : Suppose that the user wants to plot more than four EMTP variables on the same graph. He simply places these on as many different plot specification cards (Point 3) as he may require or desire, and then these are preceded by the appropriate "SUPERIMPOSE" card.

As an example of this usage, consider the required data cards for seven node voltages on the same graph:

```

SUPERIMPOSE                               3
144 8. 0.0 80. -20. 20.NODE1 NODE5 NODE9
144 8. 0.0 80. -20. 20.NODE3 NODE4
144 8. 0.0 80. -20. 20.BLACK          BLUE

```

Usage 2 : Suppose that the user would like to mix different plot-variable classes (e.g., node voltages and branch currents) on the same graph. Separate plot specification cards (Point 3) would be constructed for variables within any one class. These would then be preceded by the appropriate "SUPERIMPOSE" card.

As an example of this usage, consider the data cards which will plot two node voltages and one branch current on the same graph:

```

SUPERIMPOSE                               2
144 8. 0.0 80. -20. 20.NODE3 NODE4
194 8. 0.0 80. -4.0 4.0BUSK  BUSM

```

Usage 3 : Suppose that the user wants to compare two or more curves which are similar. If such curves were plotted to the same scale on the same plot, it would be difficult to distinguish one from the other. One possible remedy is to offset one or more of the curves vertically. In the case of three curves, there would be 3 separate plot specification cards (Point 3); the vertical offset for each is produced by adding the appropriate constant to both "VMIN" and "VMAX" of columns 16-24 . As usual, such plot specification cards would be preceded by the appropriate "SUPERIMPOSE" card, in this case having a "3" punched in column 32 .

As an example of this usage, consider the case of three node voltages. The second is to be offset one inch above the first, and the third is to be offset one inch above the second. Also, vertical-axis labeling is to be suppressed, note:

```

SUPERIMPOSE                               3
144 8. 0.0 80. -20. 20.NODE1
144 8. 0.0 80. -25. 15.NODE2
144 8. 0.0 80. -30. 10.NODE3
    
```

Usage 4 : Suppose that the user wants to suppress all axis labeling on a conventional plot (not uncommon in the case of publication). To do this, the usual plot card would be preceded by a "SUPERIMPOSE" card having a "1" punched in columns 40 and 48 . There will not actually be any superposition as such, of course. Rather, the user is merely exploiting the axis-labeling suppression which is available only via the "SUPERIMPOSE" feature.

As an example of this usage, consider the case of two node voltages, for which no vertical-axis labeling is desired:

```

SUPERIMPOSE                               1
144 8. 0.0 80. -20. 20.NODE1           NODE9
    
```

In the case of "SUPERIMPOSE" usage, variable identification has been modified (compared with Rule 7) so as to account for a large number of variables. The curve number (e.g., "7"), the curve symbol (e.g., "+"), and the one or two 6-character identifying names are all drawn side by side. This begins in the upper right hand corner, and proceeds downward in order, spaced four per inch. A sample is shown at the right, below. Standard CalComp symbols have been used, the first few of which have the following correspondance:

1	2	3	4	5	6	7	8	9
⊙	△	+	×	◇	⊕	⊗	z	Y

1	⊙	GEN	PRI
2	△	CATH	SEC
3	+	LOAD	

Vertical-axis scaling is unambiguous if the user does the scaling himself, manually (i.e., by punching fields "VMIN" and "VMAX" of columns 16-24 of the Point 3 plot-specification card). But if these vertical-axis fields are left blank, then the EMTP will perform its own scaling, and the user will be forced to figure this out after the fact for variables of the second and later plot-specification cards. Remember, only the vertical axis for the first such card is drawn, and even this can be suppressed if so desired by the user! As a general rule, it is recommend that the user do all of his own vertical-axis scaling, on those plots which involve the "SUPERIMPOSE" usage.

As for time-axis scaling, it is assumed that the user has enough sense to keep this the same for all superimposed plots, if this is what he really wants (and it normally is). There are exceptions, however, such as comparing different segments of the same curve. If the time-axis scaling is varied within a group of superimposed plots, the user is simply advised to be careful, and to remember what he did, since only the time axis of the first plot-specification card will be drawn on the graph.

```

PRINT HEAD OFF
SUPERIMPOSE          2          1
194 2. 0.0 15. -12. 12.GEN  PRI  CATH  SEC
144 2. 0.0 15. -20. 20.LOAD

```

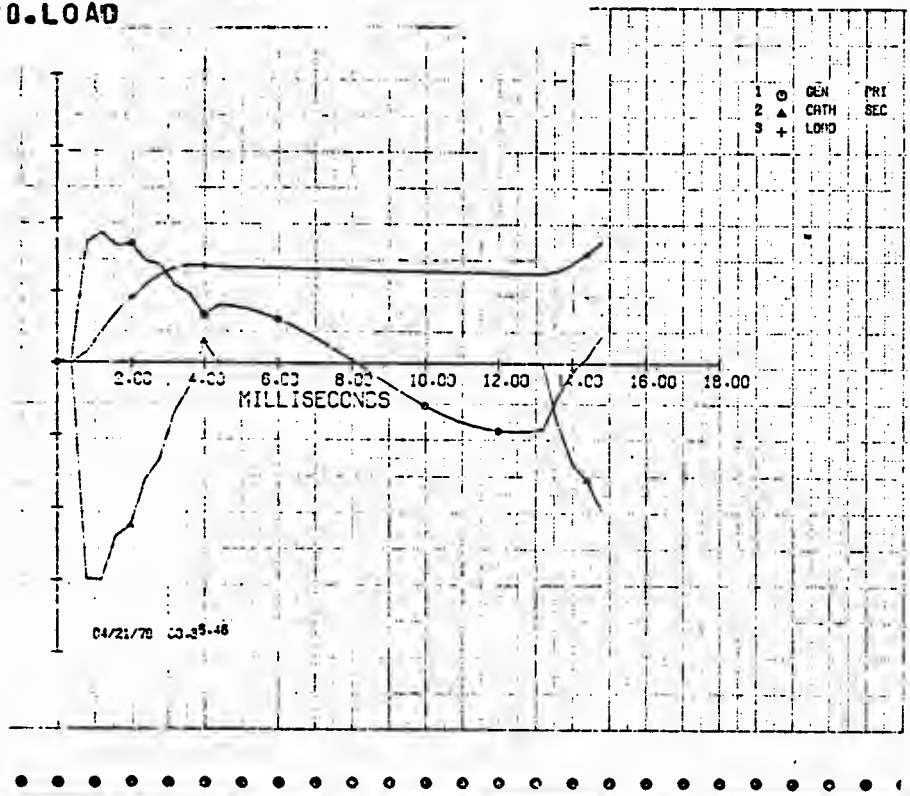

Rule 2 : Three special, new cards signal the request for "X-Y PLOT" usage:

Card 1 :

X-Y PLOT	4A6
request word	Horizontal-axis label

- (3-10) — Special request word "X-Y PLOT" is punched in columns 3 through 10 .
- (15-38) — Arbitrary 24-character title for the horizontal axis.

Card 2 :

E8.0	E8.0	E8.0
LENX	XMIN	XMAX

- (1-8) — Variable "LENX" , the length of the horizontal ("X") axis, in inches. Zero or blank is defaulted to eight (8.0) inches.
- (9-16) — Variable "XMIN" , the minimum "X" value (value at left end of horizontal axis).
- (17-24) — Variable "XMAX" , the maximum "X" value (value at the right end of the horizontal axis).

Note : If the user leaves both "XMIN" and "XMAX" blank, the EMTP will automatically choose these values to cover the curve being plotted (by means of call to CalComp "SCALE").

Card 3 :

E8.0	E8.0	E8.0	E8.0	E8.0
LENY	YMIN	YMAX	DIV	SYM

- (1-24) — Variables "LENY" , "YMIN" , and "YMAX" , which are analogous to the x-axis variables of Card 2 — only here parameters are for the vertical ("Y") axis.
- (25-32) — Number of divisions per inch of the graph paper which is being drawn on. This is used as a parameter for CalComp module "SCALE" . A zero or blank field is defaulted to ten (10.0).
DIV
- (33-40) — One less than the number of symbols which is used to identify the curves. Zero or blank is interpreted to mean that no symbols shall be placed on the curves for purposes of identification. Standard CalComp identification symbols are used, based on the curve number.
SYM

Rule 3 : The above cards are to be followed by a conventional EMTF plot-specification card (see page 40d of the User's Manual). Some fields are ignored, however, and others have an altered meaning. Supply the following information:

- (1-2) ——— Punch "1" in column 2, always.
- (3) ——— Graph type code. Use "4" for node voltages, "8" for branch voltages, and "9" for branch currents.
- (4) ——— A code-integer for the units of the column 8-15 time specification. Use "4" for milliseconds, etc., as with conventional plots.
- (8-11) ——— Minimum or beginning time of the points to be plotted, in units of the column-4 specification.
- (12-15) ——— Maximum or ending time of the points to be plotted, in units of the column-4 specification.
- (25-30)
(31-36)
(37-42)
(43-48)
- Six-character names (A6 format) of EMTF variables which are to be plotted. The first two variables are for one curve, as an ordered (X,Y) pair of variables. For node voltages, then, columns 25-36 identify the first curve (with the X-name appearing first), and columns 37-48 identify the second (if a second exists). For branch voltages or branch currents, a pair of names is required for variable identification, recall (e.g., columns 25-36 just for the X-variable); for more than one curve of branch variables, the "BRANCH" option can be used (see Point 4, page 40g of the User's Manual).

As an example of "X-Y PLOT" usage, see the plot at the top of page 8, on the left. The data cards which were read by overlay-31 plotting to produce this plot are listed as follows:

```

--- PRINT HEAD OFF
 2TEST OF TYPE-96 PSEUDO-NONLINEAR HYSTERETIC REACTANCE ELEMENT.
  FLUX VS. CURRENT HYSTERESIS PLOT OF NED AND JIH'S TYPE-96 PSEUDO-NONLINEAR
--- ELEMENT. SINUSOIDAL DRIVING VOLTAGE IS USED.
 X-Y PLOT TYPE-96 CURRENT IN AMPS
   5.0      -4.0      4.0
  6.8      -1.7      1.3      8.8
194      0.8 25.      TACS CURR TACS FLUX - HYSTERESIS GRAPHFLUX IN VOLT-SEC

```

Should the user want to switch back to conventional plotting after he is done with his X-Y PLOT usage, a simple trick is required. Repeat the three cards of the request which switched to X-Y PLOT usage in the first place, only with LENX = 9999. This is taken as a special flag meaning that a return to conventional (vs. time) plotting is desired.

In order for the Y-axis labeling (numbers) of a printer plot to be correct, LENY = 13.0 is required. For any other Y-axis length, the user should disregard the Y-axis numbers of a printer plot of the X-Y PLOT type. The curve itself should be validly constructed according to the user's requested axis scaling, however.

Extra working space is required for X-Y printer plots, beyond that needed for conventional (time) plots. This is invisible, and neither affects the user nor the computer (no additional arrays were added to the EMTP), as long as sufficient working space remains. Variable dimensioning (see Section 0.6) is the key determiner, in that it fixes the size of working space COMMON /C31B01/ KARRAY(?????) according to the total size of /LABEL/ , plus (usually minus) any additional user-requested offset. This same working space is used for building the X-Y PLOT image from the raw data points of the curves in question. For 130 cells of resolution in both directions, 16900 INTEGER cells of extra storage are required (in addition to space to store the raw data points for the curve or curves). If sufficient working space for such an image is not available, there will be a non-fatal error message, and the plot card will simply be skipped.

The "X-Y PLOT" option is available for both printer plots and CalComp plots, in any combination. But when using both via the "CALCOMP PRINTER" request, many users will have a conflict between the 13-inch wide printer output (131 columns at 10 columns/inch) and their narrower plotter (our BPA Versatek is 11 inches). There is trouble with the Y-axis length, which runs across the paper of both devices. If a CalComp plot was really desired, the upper quarter of it should not be lost off the upper edge of the paper, so LENY, YMIN, and YMAX should be selected to fit this smaller width. The printer plot will still be produced, and according to this requested scale. But the user should be warned that the Y-axis and its marking will be erroneous. Logic for printing and putting numbers on the Y-axis was fixed for 131 column output back in the year one (1975?), and is not now (September, 1980) being altered to accommodate this special case. Hence, if X-Y plotting in the "CALCOMP PRINTER" mode is used, and if the Y-axis length does not correspond to the full line printer width, the printed Y-axis will be erroneous, and should be ignored.

As for the resolution in each direction (number of cells/inch), for a printer plot, this is under user control. Recall that variable LNPIN gives the number of printer lines per inch; while it should be automatically defined according to local usage (in module "SYSDEP" of overlay 1), it can be altered by the user as per Section 1.0c. As for the number of characters/inch across a printed line, this is nominally set at 10, corresponding to conventional older printers. If the X-Y PLOT user really wants to redefine it, however, he can do so via a sixth field (cols. 41-48) on the Y-axis card. This extra field is also E8.0 information. But such an over-ride will not affect the Y-axis and its labeling, which has 10 built into it. If the user over-rides the 10 characters/inch, then, he should ignore the numbers on the printed Y-axis.

ELECTROMAGNETIC TRANSIENTS PROGRAM (EMTP), DIGITAL (DEC) VAX-11/780 TRANSLATION AS USED BY BPA IN FOR
 DATE (MM/DD/YY) AND TIME OF DAY (HH.MM.SS.)= 09/30/80 22.54.40 VAX/VMS PLOT FILE = 930225440.PL4
 FOR INFORMATION, CONSULT THE 700-PAGE EMTP RULE BOOK DATED SEPTEMBER, 1980. PROGRAM VERSION = "M29.
 INDEPENDENT LIST LIMITS FOLLOW. TOTAL LENGTH OF /LABEL/ EQUALS 249871 INTEGER WORDS. 603
 125 6100 10000 50 300 100 140 20 9000 400 9 4 30 6000 27600 220 80

 DESCRIPTIVE INTERPRETATION OF NEW-CASE INPUT DATA 1 INPUT DATA CARD IMAGES PRINTED BELOW, ALL 90 COLU
 0 1 2 3 4 5
 0 0 0 0 0 0

 MARKER CARD PRECEDING NEW DATA CASE. 1BEGIN NEW DATA CASE
 MISC. DATA, 0.100E+01 0.900E+01 0.000E+00 1 1.0 9.0
 MISC. DATA, 1 1 0 0 0 0 0 0 0 1 1 1
 SERIES R-L-C, 0.100E+01 0.000E+00 0.000E+00 1 VALUE 1.0
 BLANK CARD TERMINATING BRANCH CARDS. 1BLANK CARD ENDING BRANCH CARDS.
 BLANK CARD TERMINATING SWITCH CARDS. 1BLANK CARD ENDING SWITCH CARDS.
 SOURCE, 0.00E+00 0.00E+00 0.00E+00 0.00E+00 1 1VALUE
 BLANK CARD TERMINATING SOURCE CARDS. 1BLANK CARD ENDING SOURCE CARDS.
 REQUEST FOR OUTPUT OF ALL NODE VOLTAGES. 1 1

COLUMN HEADINGS FOR THE 1 EMTP OUTPUT VARIABLES FOLLOW. THESE ARE ORDERED ACCORDING TO THE FIVE
 POSSIBLE EMTP OUTPUT-VARIABLE CLASSES, AS FOLLOWS

FIRST 1 OUTPUT VARIABLES ARE ELECTRIC-NETWORK NODE VOLTAGES (WITH RESPECT TO LOCAL GROUND) |
 NEXT 0 OUTPUT VARIABLES ARE BRANCH VOLTAGES (VOLTAGE OF UPPER NODE MINUS VOLTAGE OF LOWER NODE) |
 NEXT 0 OUTPUT VARIABLES ARE BRANCH CURRENTS (FLOWING FROM THE UPPER EMTP NODE TO THE LOWER) |
 NEXT 0 OUTPUT VARIABLES PERTAIN TO DYNAMIC SYNCHRONOUS MACHINES, WITH NAMES GENERATED INTERNALI |
 FINAL 0 OUTPUT VARIABLES BELONG TO 'TACS' (NOTE INTERNALLY-ADDED UPPER NAME OF PAIR).
 BRANCH POWER CONSUMPTION (POWER FLOW, IF A SWITCH) IS TREATED LIKE A BRANCH VOLTAGE FOR THIS GROUP |
 BRANCH ENERGY CONSUMPTION (ENERGY FLOW, IF A SWITCH) IS TREATED LIKE A BRANCH CURRENT FOR THIS GROUP |

STEP	TIME	VALUE
0	0.000000	0.000000E+00
ANOTHER INPUT CARD FOR TYPE 1-10 SOURCES,		1 3.4
1	0.100E+01	0.340000E+01
ANOTHER INPUT CARD FOR TYPE 1-10 SOURCES,		1,8485282
2	0.200E+01	0.848528E+00
ANOTHER INPUT CARD FOR TYPE 1-10 SOURCES,		1 0.0
3	0.300E+01	0.000000E+00
ANOTHER INPUT CARD FOR TYPE 1-10 SOURCES,		1-,434314
4	0.400E+01	-0.434314E+00
ANOTHER INPUT CARD FOR TYPE 1-10 SOURCES,		1 -.2
5	0.500E+01	-0.200000E+00
ANOTHER INPUT CARD FOR TYPE 1-10 SOURCES,		1-,848528
6	0.600E+01	-0.848528E+00
ANOTHER INPUT CARD FOR TYPE 1-10 SOURCES,		1 -.4
7	0.700E+01	-0.400000E+00
ANOTHER INPUT CARD FOR TYPE 1-10 SOURCES,		1-1.56569
8	0.800E+01	-0.156569E+01
ANOTHER INPUT CARD FOR TYPE 1-10 SOURCES,		1 1.0

COMMENT CARD. 1C 345678901234567890123456789012
 FOURIER SERIES STARTED, NFOUR = 10 1 FOURIER ON 10
 ** PLOT CARD. 0.100E+01 0.100E+01 0.800E+01 1 143 1. 1.0 8.0 VALUE

BEGIN FOURIER SERIES CALCULATION USING 8 EQUIDISTANT POINTS. BEGINNING TWO POINTS =
 0.3400000000E+01 0.8485282000E+00 ENDING TWO POINTS = -0.4000000000E+00 -0.1565690

COEFFICIENTS OF RESULTANT FOURIER SERIES, WITH "COMPLEX AMPLITUDE" BEING THE SQUARE ROOT
 OF THE SUM OF THE SQUARES OF THE TWO PRECEDING ENTRIES. THE FINAL COLUMN APPLIES TO THIS AMPLITUDE

HARMONIC NUMBER	COSINE COEFFICIENT	SINE COEFFICIENT	COMPLEX AMPLITUDE	FRACTION OF FUNDAMENTAL
0	0.9999952500E-01	0.0000000000E+00	0.9999952500E-01	0.08574891
1	0.999990764E+00	0.600008972E+00	0.1166190049E+01	1.00000000
2	0.9000000000E+00	0.5000010500E+00	0.1029563524E+01	0.88284369
3	0.8000009236E+00	0.400008972E+00	0.8944284184E+00	0.76696626
4	0.6000004750E+00	0.0000000000E+00	0.6000004750E+00	0.51449631

BLANK CARD TERMINATING PLOT SPEC. CARDS. 1BLANK CARD ENDING PLOT CARDS.

The sample usage just displayed is based on Hermann's 8-point illustration in the documentation which follows. A user-defined Type-1 EMTP source was employed to establish the eight desired data points as node voltages for node VALUE. Due to the EMTP field width of eight, precision is slightly reduced, note.

The user is reminded of the importance of defining exactly one cycle of the periodic wave, with no overlap. Because of the floating-point counting of the EMTP ($T = T + DELTAT$), this can be tricky, and even installation-dependent. The first two points and the last two points are printed out as confirmation, so that the user knows that his window is exactly right. In this regard, all plot points for $T.LT.HMIN$ or $T.GT.HMAX$ are rejected. If the user is having trouble with one or both end points, he may want to add or subtract half a time step when he defines HMIN and HMAX; and if this requires more field width than the regular format allows, remember the extended (16-column) precision option of Point 5 plot data.

The user is also warned that no interpolation on the EMTP plot file points is performed. Hence it is important that time-step size DELTAT (as defined on the floating-point miscellaneous data card) be an exact multiple of the period. For 50 Hz problems, this will usually be the case, but not so for we North American users of 60 Hz systems. Remember, if $DELAT = 1.E-4$ sec, then there are exactly 166.666666.... steps in a cycle, which implies some error in the Fourier transformation. Better to choose DELTAT so that the number of steps per cycle is an integer. For 60 Hz systems, carry quite a bit of precision, preferably using free-format capability for the floating-point miscellaneous data card. Put several extra commas at the end of the nonzero data, so ensure proper bounding.

One final point regarding the FORTRAN, which is module "SERIES" of overlay 31. An interactive debugger can stop at S.N. 3209 and examine and or adjust various variables. (EVDOUB(J), J=1, KPL) is the data being transformed, and IPRSUP .GE. 3 will print it all.

Point 17 : Card to turn off Fourier Analysis, and return to plotting.

If the user wants to return to conventional EMTP plotting after the use of Point 16 Fourier transformation, this is possible. The switch back to the normal plotting mode is made via the "FOURIER OFF" request as shown at the right.

1	2	3	4	5	6	7	8	9	10	11	12	13	14	15	16
FOURIER OFF															

=====
 BACKGROUND AND DOCUMENTATION OF EMTP FOURIER SERIES COMPUTATION
 =====

The Point 16 and Point 17 features were implemented very hurriedly by WSM on September 29th and 30th, 1980, just as this manual was going to press. It was a rush job, in response to Bob Hasiber's immediate need. Hermann had written a little self-contained Fourier analysis program many years ago, and it is his coding which formed the basis of the new EMTP feature. The first three pages of Hermann's five-page writeup dated 30 October 1972 are reproduced below as added documentation of the formulas used:

Ref: Mathematical Methods for Digital Computers, edited by A. Ralston & H. S. Wilf. John Wiley & Sons, New York 1960. Paper by G. Goertzel: Fourier Analysis, page 258-262

Given a periodic function $f(x)$:

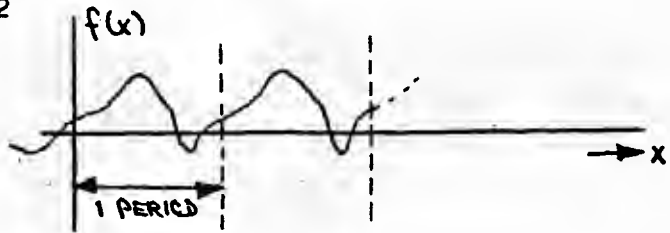

This periodic function can be expressed as a series of trigonometric functions

$$f(x) = \sum_{i=0}^{\infty} a_i \cos(ix) + \sum_{i=0}^{\infty} b_i \sin(ix) \quad (1)$$

with a_0 = dc offset,

$$\sqrt{a_1^2 + b_1^2} = \text{amplitude of fundamental frequency, and}$$

$$\sqrt{a_i^2 + b_i^2} = \text{amplitude of } i\text{-th harmonic.}$$

How to Use the Program

Define the curve within one period by n points at equal distances along x ($n \geq 2$):

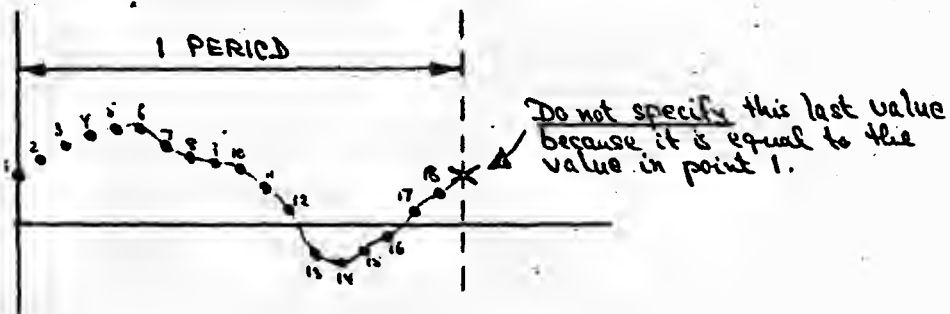

The program will compute the values a_0, \dots, a_m (cosine-coefficients) and b_0, \dots, b_m (sine-coefficients) of Eq. (1), as well as the magnitudes C_0, \dots, C_m , with

$$C_i = \sqrt{a_i^2 + b_i^2} \quad (2)$$

If n is even, then

$$m = \frac{n}{2} \quad (3a)$$

if n is odd, then

$$m = \frac{n-1}{2} \quad (3b)$$

The resulting finite series

$$F(x) = \sum_{i=0}^m a_i \cdot \cos(ix) + \sum_{i=0}^m b_i \cdot \sin(ix) \quad (4)$$

passes through the n given points ("exactly," except for round-off errors) and provides a smooth interpolation between points with the least possible number of harmonics.

Any number of curves can be analyzed consecutively. Each curve is specified with

one card defining

n

Format I3

as many cards as necessary defining $f_1, f_2, f_3, f_4, f_5, f_6$
 f_7, \dots f_{12}
 \dots

Format 6F12.7

NO longer applicable

Terminate the data deck with a blank card.

Test Examples

Example A: The function

$$f(x) = 0.1 + \cos x + 0.9 \cos 2x + 0.8 \cos 3x + 0.6 \cos 4x + 0.6 \sin x + 0.5 \sin 2x + 0.4 \sin 3x + 0.8 \sin 4x$$

was used to generate 8, 9 and 20 values at equidistant points to define one period of the periodic function. These points were used as input to generate the coefficients, which agreed with those of the original function as shown on p. 3.

Example B: The curve was taken from a study described in E. J. Dolan, D. A. Gillies, and E. W. Kimbark, "Ferroresonance in a Transformer Switched with an EHV Line,"

IEEE Trans. on Power Apparatus and Systems, Vol. PAS-91, May/June 1972, pp. 1273-1280.

The curve as well as the results are shown on p. 4-5.

FOURIER ANALYSIS

Example A. Results

A. W. Dommel
 10/30/72

RECORD OF ORDINATES IN 8 EQUIDISTANT POINTS

3.3999999	.8485282	-0.0000000	-.4343144	-.2000000	-.8485281
-.3999999	-1.5655856				

FOURIER COEFFICIENTS

HARMONIC	COS-COEFF.	SIN-COEFF.	MAGNITUDE
0	.100000	0.000000	.100000
1	1.000000	.500000	1.166190
2	.900000	.500000	1.029563
3	.800000	.400000	.894427
4	.500000	0.000000	.600000

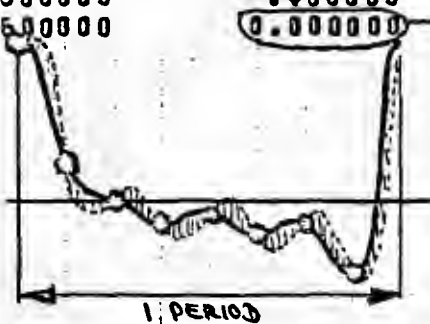

With 8 points given, the sine-term of the 4th harmonic can no longer be recognized (it could be anything; see dashed line at left). Therefore, it is set to zero.

FOURIER ANALYSIS

43m

RECORD OF ORDINATES IN 9 EQUIDISTANT POINTS

3.3999999 1.5556150 -.6111941 .4294230 -1.0036814 .1115541
 -1.1294229 -.4137028 -1.4335908

FOURIER COEFFICIENTS

HARMONIC	COS-COEFF.	SIN-COEFF.	MAGNITUDE
0	.100000	0.000000	.100000
1	1.000000	.500000	1.166190
2	.900000	.500000	1.029563
3	.800000	.400000	.894427
4	.600000	.800000	1.000000

FOURIER ANALYSIS

RECORD OF ORDINATES IN 20 EQUIDISTANT POINTS

3.3999999 3.9985650 2.1333587 -.2222683 -.9123345 -.0000001
 .6979639 .1132515 -.8817609 -.9534801 -.2000001 .1379616
 -.4564355 -1.0941824 -.9059809 -.3999999 -.6494687 -1.4509024
 -1.2243422 .8718544

FOURIER COEFFICIENTS

HARMONIC	COS-COEFF.	SIN-COEFF.	MAGNITUDE
0	.100000	0.000000	.100000
1	1.000000	.500000	1.166190
2	.900000	.500000	1.029563
3	.800000	.400000	.894427
4	.600000	.800000	1.000000
5	.000000	.000000	.000000
6	.000000	.000000	.000000
7	.000000	-.000000	.000000
8	.000000	-.000000	.000000
9	.000000	-.000000	.000000
10	.000000	0.000000	.000000

-3-

Point 18 : Card to begin each PRINTER PLOT on a new page

A plot card with "PAGE" punched in columns 3-6 will produce a page skip on the line printer just prior to the output of each new PRINTER PLOT.

For those not having high-resolution (vector-graphic) plot capability, PRINTER PLOTS are very important. Some printers do not print continuously over the fold of line printer paper, thereby breaking PRINTER PLOTS and inserting about an inch of blank space. Or, even if the printer does print continuously over folds, some users may choose to separate pages along fold lines for purposes of record keeping. In either case, the beginning of a PRINTER PLOT at the top of a line printer page may be important.

Point 19 : Card to mark the termination of all plot cards

A blank card is used to signal the end of all data cards that are associated with plotting. This then also completes the data for the data case being set up (see Section 1.).

2. DESCRIPTION OF TRANSIENTS PROGRAM OUTPUT

This chapter is designed to aid the user in interpreting the printed (and plotted) output produced by the Transients Program.

2.1 Input Data Listing

So as to completely document all data, a listing of all input cards is provided as part of the printed output:

1. All 80 columns are printed, character by character, in columns 52 through 131 of the paper.
2. The character "1" is printed in column 51 of the line, to mark the beginning of the card image.
3. Columns 1 through 50 of the line are reserved for interpretation of the input card in question. See below for a tabulation of what is printed out for different types of data cards.
4. There is only one line of printing for each data card read; no spill-over to extra lines is allowed, for aesthetic reasons.

See the sample program output of Section 2.3 for an illustration of these rules.

As not all data cards are inputted at once, "breaks" in the above card-listing will occur, with other program printout appearing in between. Yet all data from the case control card through the source cards (see Point a of Section 1., data classes 1 through 5) will appear listed contiguously — which is the most important range of interest, covering the entire network description.

The interpretation accompanying each different type of input card can be decoded using the following explanations.

① Comment Card (Section 1.)

1	2	3	4	5	6	7	8	9	10	11	12	13	14	15	16	17	18	19	20	21	22	23	24	25	26	27	28	29	30	31	32	33	34	35	36	37	38	39	40	41	42	43	44	45	46	47	48	49	50	51
COMMENT CARD.																																																		

② Cards to Begin a New Data Case (Section 1.0)

First, there are the two different cards which are associated with separating different data cases, or stopping execution of the EMTP (see Sections 1.0a, 1.0b). Of the two interpretations shown below, the first is for a "BEGIN NEW DATA CASE" card, the second is for the blank card which turns the EMTP off.

1	2	3	4	5	6	7	8	9	10	11	12	13	14	15	16	17	18	19	20	21	22	23	24	25	26	27	28	29	30	31	32	33	34	35	36	37	38	39	40	41	42	43	44	45	46	47	48	49	50	51
MARKER CARD PRECEDING NEW DATA CASE.																																																		1
BLANK TERMINATION-OF-RUN CARD.																																																		1

Section 1.0c shows how the user can re-define built-in program parameters "LNPIN", "SZPLT", "NSMTH", "EPSILN", "KPARTB", and "STATFR". Interpretation for these special request records is as follows:

1	2	3	4	5	6	7	8	9	10	11	12	13	14	15	16	17	18	19	20	21	22	23	24	25	26	27	28	29	30	31	32	33	34	35	36	37	38	39	40	41	42	43	44	45	46	47	48	49	50	51
NEW PRINTER SPACING, LINES/DISTANCE =																																						I8												
																																						LNPIN												

1	2	3	4	5	6	7	8	9	10	11	12	13	14	15	16	17	18	19	20	21	22	23	24	25	26	27	28	29	30	31	32	33	34	35	36	37	38	39	40	41	42	43	44	45	46	47	48	49	50	51
NEW PLOTTER PAPER-HEIGHT LIMIT.																																						E13.3												
																																						SZPLT												

1	2	3	4	5	6	7	8	9	10	11	12	13	14	15	16	17	18	19	20	21	22	23	24	25	26	27	28	29	30	31	32	33	34	35	36	37	38	39	40	41	42	43	44	45	46	47	48	49	50	51
CHANGE SUCCESSIVE OSCILLATION LIMIT.																																						I8												
																																						NSMTH												

1	2	3	4	5	6	7	8	9	10	11	12	13	14	15	16	17	18	19	20	21	22	23	24	25	26	27	28	29	30	31	32	33	34	35	36	37	38	39	40	41	42	43	44	45	46	47	48	49	50	51
MISC. DATA CONSTANT 'EPSILN'.																																						E12.3												
																																						EPSILN												

1	2	3	4	5	6	7	8	9	10	11	12	13	14	15	16	17	18	19	20	21	22	23	24	25	26	27	28	29	30	31	32	33	34	35	36	37	38	39	40	41	42	43	44	45	46	47	48	49	50	51
EXPONENT OF HIGH RESISTANCE. R =																																						E12.2												
																																						10 KPARTB												

1	2	3	4	5	6	7	8	9	10	11	12	13	14	15	16	17	18	19	20	21	22	23	24	25	26	27	28	29	30	31	32	33	34	35	36	37	38	39	40	41	42	43	44	45	46	47	48	49	50	51				
REDEFINED POWER FREQUENCY =																																						E12.3				HZ.												
																																						STATFR																

Section 1.0d explains usage of the "REPLOTT" feature, the leading request card for which is interpreted as follows:

1	2	3	4	5	6	7	8	9	10	11	12	13	14	15	16	17	18	19	20	21	22	23	24	25	26	27	28	29	30	31	32	33	34	35	36	37	38	39	40	41	42	43	44	45	46	47	48	49	50	51
REQUEST TO RE-PLOT OLD PLOT DATA.																																																		1

Section 1.0e explains how installation-dependent module "MIDOV1" of overlay number one can be called on demand by the user. Interpretation of the special request record reading "FILE REQUEST" is as follows:

1	2	3	4	5	6	7	8	9	10	11	12	13	14	15	16	17	18	19	20	21	22	23	24	25	26	27	28	29	30	31	32	33	34	35	36	37	38	39	40	41	42	43	44	45	46	47	48	49	50	51
CALL SUBROUTINE "MIDOV1" .																																																		1

Section 1.0e1 explains how six-character alphanumeric identification of the user can be specified, principally for purposes of EMTF plot identification. Interpretation of the special request record reading "USER IDENTIFICATION" is as follows:

1	2	3	4	5	6	7	8	9	10	11	12	13	14	15	16	17	18	19	20	21	22	23	24	25	26	27	28	29	30	31	32	33	34	35	36	37	38	39	40	41	42	43	44	45	46	47	48	49	50	51	
USER IDENTIFICATION.																						AG																													1
																						USERID																													1

Section 1.0e2 explains how to disable the execution of an EMTF data case (one of several to be solved). Interpretation of the special request record reading "ABORT DATA CASE" is as follows:

1	2	3	4	5	6	7	8	9	10	11	12	13	14	15	16	17	18	19	20	21	22	23	24	25	26	27	28	29	30	31	32	33	34	35	36	37	38	39	40	41	42	43	44	45	46	47	48	49	50	51
REQUEST TO ABORT THIS DATA CASE.																																																		1

Section 1.0e3 explains how to print a range of EMTF error messages (KILL codes, beginning with KILL1 and continuing through KILL2). Interpretation of the special request record reading "KILL CODES" is:

1	2	3	4	5	6	7	8	9	10	11	12	13	14	15	16	17	18	19	20	21	22	23	24	25	26	27	28	29	30	31	32	33	34	35	36	37	38	39	40	41	42	43	44	45	46	47	48	49	50	51
LISTING OF ERROR MESSAGES.																		I8		I8																													1	
																		KILL1		KILL2																													1	

Section 1.0e4 explains how the EMTF output vectors can be averaged over successive time steps. Interpretation of the special request record reading "AVERAGE OUTPUT" is as follows:

1	2	3	4	5	6	7	8	9	10	11	12	13	14	15	16	17	18	19	20	21	22	23	24	25	26	27	28	29	30	31	32	33	34	35	36	37	38	39	40	41	42	43	44	45	46	47	48	49	50	51
REQUEST TO AVERAGE (SMOOTH) OUTPUT.																																																		1

Section 1.0e5 explains how the total TACS working space of List 19 can be allocated among the 15 different TACS tables. First, there is interpretation for the three "ABSOLUTE TACS DIMENSIONS" cards:

Section 1.0e12 explains how the user can define the table-saving time in the case of "STATISTICS" data cases. Interpretation of the special request record "TIME OF DICE ROLL" is as follows:

1	2	3	4	5	6	7	8	9	10	11	12	13	14	15	16	17	18	19	20	21	22	23	24	25	26	27	28	29	30	31	32	33	34	35	36	37	38	39	40	41	42	43	44	45	46	47	48	49	50	51
STATISTICS TABLE-SAVING TIME =																															E12.3				SEC.															
TENERG																																																		

Section 1.0e13 explains how the user can request output of the peak node voltage for the entire network (peak over all nodes). The special request record "PEAK VOLTAGE MONITOR" is interpreted as:

1	2	3	4	5	6	7	8	9	10	11	12	13	14	15	16	17	18	19	20	21	22	23	24	25	26	27	28	29	30	31	32	33	34	35	36	37	38	39	40	41	42	43	44	45	46	47	48	49	50	51
OVERALL PROBLEM PEAK NODE VOLTAGE.																																																		1

Section 1.0e14 explains how the total U.M. working space of List 25 can be allocated among the four different U.M. tables. First, there is interpretation of the "ABSOLUTE U.M. DIMENSIONS" card:

1	2	3	4	5	6	7	8	9	10	11	12	13	14	15	16	17	18	19	20	21	22	23	24	25	26	27	28	29	30	31	32	33	34	35	36	37	38	39	40	41	42	43	44	45	46	47	48	49	50	51
U.M. TABLE SIZES.																				IG					IG					IG					IG															
																				NCLFIX					NUMFIX					IOTFIX					IBSFIX															

An alternative is provided by the special request "RELATIVE U.M. DIMENSIONS", which is interpreted as follows. Note that the derived absolute sizes, not the proportions, are printed:

1	2	3	4	5	6	7	8	9	10	11	12	13	14	15	16	17	18	19	20	21	22	23	24	25	26	27	28	29	30	31	32	33	34	35	36	37	38	39	40	41	42	43	44	45	46	47	48	49	50	51
DERIVED U.M. SIZES.																				IG					IG					IG					IG															
																				NCLFIX					NUMFIX					IOTFIX					IBSFIX															

Section 1.0e15 explains how the user can restart a previously-halted simulation (which had MEMSAV = 1 flag set). There are several data cards associated with this operation. The first of these is the special request record "START AGAIN", which is interpreted as:

1	2	3	4	5	6	7	8	9	10	11	12	13	14	15	16	17	18	19	20	21	22	23	24	25	26	27	28	29	30	31	32	33	34	35	36	37	38	39	40	41	42	43	44	45	46	47	48	49	50	51
CONTINUE PARTIALLY-COMPLETED DATA CASE.																																																		1

Section 1.0g shows how the user can request transfer to any of the auxiliary supporting programs which have been attached to the Transients Program proper. The different possible request records are interpreted as follows (for key words "XFORMER", "SATURATION", "WEIGHTING", "LINE CONSTANTS", "SEMLYEN SETUP", "AMETANI SETUP", and "CABLE CONSTANTS") :

1	2	3	4	5	6	7	8	9	10	11	12	13	14	15	16	17	18	19	20	21	22	23	24	25	26	27	28	29	30	31	32	33	34	35	36	37	38	39	40	41	42	43	44	45	46	47	48	49	50	51
REQUEST FOR TRANSFORMER IMPEDANCE-MATRIX ROUTINE.																																																	1	
REQUEST FOR MAGNETIC-SATURATION ROUTINE.																																																	1	
REQUEST FOR WEIGHTING-FUNCTION ROUTINE.																																																	1	
REQUEST FOR LINE-CONSTANTS SUPPORTING PROG.																																																	1	
REQUEST FOR SEMLYEN STEP-RESPONSE ROUTINE.																																																	1	
REQUEST FOR AMETANI STEP-RESPONSE ROUTINE.																																																	1	
REQUEST FOR CABLE-CONSTANTS SUPPORTING PROGRAM.																																																	1	
REQUEST FOR HAUER STEP-RESPONSE ROUTINE.																																																	1	

Section 1.0g1 explains that the intended control of Type 1-10 EMTF sources from FORTRAN subroutine "ANALYT" must be declared early, by means of a card bearing the key word "ANALYTIC SOURCES". Interpretation of this special-request record is as follows:

1	2	3	4	5	6	7	8	9	10	11	12	13	14	15	16	17	18	19	20	21	22	23	24	25	26	27	28	29	30	31	32	33	34	35	36	37	38	39	40	41	42	43	44	45	46	47	48	49	50	51
REQUEST FOR USE OF ANALYTIC TYPE 1-10 SOURCES.																																																	1	

Section 1.0g2 explains that Type 1-10 EMTF sources can be controlled by TACS variables which are declared on a "TACS EMTF SOURCES" card. Interpretation of this special-request record is as follows:

1	2	3	4	5	6	7	8	9	10	11	12	13	14	15	16	17	18	19	20	21	22	23	24	25	26	27	28	29	30	31	32	33	34	35	36	37	38	39	40	41	42	43	44	45	46	47	48	49	50	51
TACS NAMES CONTROLLING TYPE 1-10 EMTF SOURCES.																																																	1	

Section 1.0g3 explains that the EMTF will automatically loop over steady-state solutions of different frequencies, in response to a "FREQUENCY SCAN" card. Interpretation of this special-request record is as follows:

1	2	3	4	5	6	7	8	9	10	11	12	13	14	15	16	17	18	19	20	21	22	23	24	25	26	27	28	29	30	31	32	33	34	35	36	37	38	39	40	41	42	43	44	45	46	47	48	49	50	51
F-SCAN.					E12.3					E12.3					E12.3					I5					1																									
					f_{min}					Δf					f_{max}					NPD					1																									

Section 1.0g4 explains that transient network node renumbering can be bypassed by means of a special request card which bears the key-word text "RENUMBER BYPASS". Interpretation is as follows:

1	2	3	4	5	6	7	8	9	10	11	12	13	14	15	16	17	18	19	20	21	22	23	24	25	26	27	28	29	30	31	32	33	34	35	36	37	38	39	40	41	42	43	44	45	46	47	48	49	50	51
BYPASS OF TRANSIENT NETWORK RENUMBERING.																																																		1

Section 1.0g5 explains that the time-step size "DELTAT" can be altered by the user at any point during an EMTP simulation. Three or more cards are required for such a specification. The first is a single special-request record which bears the key-word text "CHANGE DELTAT". Then come an indeterminate number of cards which define the time-instants T_1 at which new step-sizes DT_1 are to be applicable. Finally, the end of these is marked by a single card with "9999" punched in columns 13-16. Interpretation for these three classes of cards is as follows:

1	2	3	4	5	6	7	8	9	10	11	12	13	14	15	16	17	18	19	20	21	22	23	24	25	26	27	28	29	30	31	32	33	34	35	36	37	38	39	40	41	42	43	44	45	46	47	48	49	50	51
REQUEST FOR TIME-STEP CHANGES.																																																		
BREAKPOINT.										E12.3					E12.3					15					15																									
										T_1					DT_1					NPR ₁					NPL ₁																									
SPECIAL TERMINATION-OF-POINTS CARD.																																																		

Section 1.0g6 provides for user-redefinition of the two characters which are used in conjunction with free-format data input. "CSEPAR" is the separator character between data fields, while "CHCONT" is the character which requests a continuation card. Interpretation of this special-request record which bears the key word "FREE FORMAT" is as follows:

1	2	3	4	5	6	7	8	9	10	11	12	13	14	15	16	17	18	19	20	21	22	23	24	25	26	27	28	29	30	31	32	33	34	35	36	37	38	39	40	41	42	43	44	45	46	47	48	49	50	51
FREE-FIELD CHARACTERS.																									△	AND										△	.													
																									CSEPAR					CHCONT																				

Section 1.0g6 explains that EMTP diagnostic printout can be controlled selectively, overlay by overlay, using a card which bears the key-word text "DIAGNOSTIC". Interpretation of this special-request record is as follows:

1	2	3	4	5	6	7	8	9	10	11	12	13	14	15	16	17	18	19	20	21	22	23	24	25	26	27	28	29	30	31	32	33	34	35	36	37	38	39	40	41	42	43	44	45	46	47	48	49	50	51
DIAGNOSTIC PRINTOUT CODES.																											I4	I4	I4	I4	I4																			
																											1	2	3	4	5																			
																											overlay # controlled																							

The floating-point and integer miscellaneous data cards of Section 1.0h are interpreted as follows:

1	2	3	4	5	6	7	8	9	10	11	12	13	14	15	16	17	18	19	20	21	22	23	24	25	26	27	28	29	30	31	32	33	34	35	36	37	38	39	40	41	42	43	44	45	46	47	48
MISC. DATA.												E12.3						E12.3						E12.3																							
												Δt						T _{max}						XOPT																							

1	2	3	4	5	6	7	8	9	10	11	12	13	14	15	16	17	18	19	20	21	22	23	24	25	26	27	28	29	30	31	32	33	34	35	36	37	38	39	40	41	42	43	44	45	46	47	48	49	50	51	
MISC. DATA.												I5		I5		I3		I3		I3		I3		I3		I3		I3		I3																					
												IOUT		IPL0T		ID0UBL		KSS0UT		MAX0UT		IPUN		MEMSAV		ICAT		NENERG		IPRSUP																					

3 Specially-Requested Extensions to Misc. Data Cards (Section 1.1)

This class of data consists of cards which are only present in a data case if certain miscellaneous data parameters of Section 1.0h take on special, characteristic values.

For a "STATISTICS" or "SYSTEMATIC" data case, "NENERG" is punched nonzero (with absolute value equal to the number of energizations), and an extra statistical-overvoltage miscellaneous data card is appended, as per Section 1.1a. Interpretation of this record is as follows:

1	2	3	4	5	6	7	8	9	10	11	12	13	14	15	16	17	18	19	20	21	22	23	24	25	26	27	28	29	30	31	32	33	34	35	36	37	38	39	40	41	42	43	44	45	46	47	48	49	50	51
STATISTICS DATA.												I8						I8						I8						F9.4																				
												ISW						ITEST						IDIST						AINCR																				

If the user wants to vary the printout frequency during the solution, "IPUN" is punched as -1, and the special printout-frequency-change card of Section 1.1b is appended. Interpretation of this record is as follows:

1	2	3	4	5	6	7	8	9	10	11	12	13	14	15	16	17	18	19	20	21	22	23	24	25	26	27	28	29	30	31	32	33	34	35	36	37	38	39	40	41	42	43	44	45	46	47	48	49	50	51
PRINTOUT												I6				I6				I6				I6				I6																						
												KCHG ₁				MULT ₁				KCHG ₂				MULT ₂				KCHG ₃				MULT ₃																		

3a TACS Data

If a data case is to involve TACS modeling (see Section 8.), such data cards precede the first branch card (and follow the last extension (if any) to the miscellaneous data cards).

First comes a special-request card with the keyword 'TACS HYBRID' or 'TACS STAND ALONE' . (See Section 1.1d)
Interpretation is as follows:

1	2	3	4	5	6	7	8	9	10	11	12	13	14	15	16	17	18	19	20	21	22	23	24	25	26	27	28	29	30	31	32	33	34	35	36	37	38	39	40	41	42	43	44	45	46	47	48	49	50	51	52	53
TACS SETUP. DATA CARDS FOLLOW.																																																				

Next come TACS function blocks of Section 8.5.1 , plus the zero-th order blocks of Section 8.5.2 . The first card of each function block is interpreted as follows:

1	2	3	4	5	6	7	8	9	10	11	12	13	14	15	16	17	18	19	20	21	22	23	24	25	26	27	28	29	30	31	32	33	34	35	36	37	38	39	40	41	42	43	44	45	46	47	48	49	50	51
TACS FUNCTION			A6		, ORDER		N.		E14.4																																									
			output name				Z		GAIN																																									

Here "N" is the order of the block, as read from columns 1-2 ; "output name" is the block name, as read from columns 3-8 ; and the block gain "GAIN" was read from columns 51-56.

For a dynamic block ($N > 1$), the polynomial coefficients of "s" of the transfer function follow, on two or more cards. The numerator coefficients precede the denominator coefficients. These two interpretations follow:

1	2	3	4	5	6	7	8	9	10	11	12	13	14	15	16	17	18	19	20	21	22	23	24	25	26	27	28	29	30	31	32	33	34	35	36	37	38	39	40	41	42	43	44	45	46	47	48	49	50	51
NUMER.		E10.2					E10.2					E10.2					E10.2																																	
		N ₀					N ₁					N ₂					N ₃																																	

1	2	3	4	5	6	7	8	9	10	11	12	13	14	15	16	17	18	19	20	21	22	23	24	25	26	27	28	29	30	31	32	33	34	35	36	37	38	39	40	41	42	43	44	45	46	47	48	49	50	51
DENOM.		E10.2					E10.2					E10.2					E10.2																																	
		D ₀					D ₁					D ₂					D ₃																																	

Next come TACS signal source cards of Section 8.5.4 . Interpretation is as follows, where "A" , "B" , and "C" are read from columns 11-40 using 3E10.0 format:

1	2	3	4	5	6	7	8	9	10	11	12	13	14	15	16	17	18	19	20	21	22	23	24	25	26	27	28	29	30	31	32	33	34	35	36	37	38	39	40	41	42	43	44	45	46	47	48	49	50	51
TACS SOURCE.										E12.3										E12.3										E12.3										1										
										A										B										C										1										
																																								1										
																																								1										
																																								1										

Next come TACS supplemental variables. Three types can now be defined:

- "VARIABLE" : old fixed-format expression
- "FORTRAN EXPRESSION" : new free-format logical/algebraic FORTRAN expression
- "DEVICE TYPE NN" : a TACS device type- 50, 51, 52, etc...

Each of the above may also belong to one of the three groups of supplemental variables: "inside", "input" and "output" .

The interpretation is then as follows:

1	2	3	4	5	6	7	8	9	10	11	12	13	14	15	16	17	18	19	20	21	22	23	24	25	26	27	28	29	30	31	32	33	34	35	36	37	38	39	40	41	42	43	44	45	46	47	48	49	50	51	52	53	54
TACS SUPPLEMENTAL										INPUT										VARIABLE.										1																							
										OUTPUT										FORTRAN EXPRESSION.										1																							
										INSIDE										DEVICE TYPE										1																							
																				I2										1																							
																				00AW										1																							

Certain TACS supplemental device cards may be immediately followed by an indeterminate number of associated data cards, each of which bears one or two floating-point numbers. Examples are the Type-55 digitizer, the Type-56 point-by-point nonlinearity, and the Type-57 time-sequenced switch. The end of such cards is marked by a "9999" card (punched in columns 13-16) .

Interpretations are as follows:

1	2	3	4	5	6	7	8	9	10	11	12	13	14	15	16	17	18	19	20	21	22	23	24	25	26	27	28	29	30	31	32	33	34	35	36	37	38	39	40	41	42	43	44	45	46	47	48	49	50	51
DATA VALUES.										E13.4										E13.4										1																				
										X										Y										1																				

1	2	3	4	5	6	7	8	9	10	11	12	13	14	15	16	17	18	19	20	21	22	23	24	25	26	27	28	29	30	31	32	33	34	35	36	37	38	39	40	41	42	43	44	45	46	47	48	49	50	51
END OF DATA VALUES FOR LAST-READ DEVICE.																																																		1

Next come the cards (or single card) which request TACS output variables, to be used for printing and/or plotting. For selectively-specified outputs, interpretation is:

1	2	3	4	5	6	7	8	9	10	11	12	13	14	15	16	17	18	19	20	21	22	23	24	25	26	27	28	29	30	31	32	33	34	35	36	37	38	39	40	41	42	43	44	45	46	47	48	49	50	51
TACS VARIABLES FOR EMTF OUTPUT VECTOR.																																																		1

The output of all TACS variables can be requested by a single card with a "1"-punch in column 2. Interpretation is then as follows:

1	2	3	4	5	6	7	8	9	10	11	12	13	14	15	16	17	18	19	20	21	22	23	24	25	26	27	28	29	30	31	32	33	34	35	36	37	38	39	40	41	42	43	44	45	46	47	48	49	50	51
REQUEST FOR OUTPUT OF ALL TACS VARIABLES.																																																		1

Finally come initial condition specification cards, if any. Interpretation is as follows:

1	2	3	4	5	6	7	8	9	10	11	12	13	14	15	16	17	18	19	20	21	22	23	24	25	26	27	28	29	30	31	32	33	34	35	36	37	38	39	40	41	42	43	44	45	46	47	48	49	50	51
INIT. COND.										A6										E16.6																				1										
										NAME										initial condition																				1										
																																								1										
																																								1										

4 Lumped Series R.L.C (Section 1.21)

1	2	3	4	5	6	7	8	9	10	11	12	13	14	15	16	17	18	19	20	21	22	23	24	25	26	27	28	29	30	31	32	33	34	35	36	37	38	39	40	41	42	43	44	45	46	47	48	49	50	51
SERIES R-L-C.										E11.3										E11.3										E11.3										1										
										R										L or ωL										C or ωC										1										

4a "CASCADED PI" Steady-State Component (Section 1.22)

Data input for a "branch" which is to be defined using the "CASCADED PI" feature of Section 1.22 begins with the header card (Class 1 input), which is interpreted as follows:

1	2	3	4	5	6	7	8	9	10	11	12	13	14	15	16	17	18	19	20	21	22	23	24	25	26	27	28	29	30	31	32	33	34	35	36	37	38	39	40	41	42	43	44	45	46	47	48	49	50	51
CASCADED-PI HEADER CARD.										I10										E12.4										1																				
										NPHCAS										FREQCS										1																				
																														1																				

Class 2 data defines the terminal node names at the sending and the receiving ends, as well as matrices [R], [L], and [C] for the sending-end line section. Interpretation for these data cards is identical to that used for the conventional Pi-circuit component of Section 1.23. For convenience, this interpretation explanation is reproduced immediately below:

Here a distinction is made between the card for the first conductor of a Pi-equivalent and possible succeeding cards. The first card has the following interpretation:

1	2	3	4	5	6	7	8	9	10	11	12	13	14	15	16	17	18	19	20	21	22	23	24	25	26	27	28	29	30	31	32	33	34	35	36	37	38	39	40	41	42	43	44	45	46	47	48	49	50	51
1ST OF PI-CKT.					E11.3					E11.3					E11.3																																			
					R ₁₁					L ₁₁					C ₁₁																																			

The first card of succeeding conductors of a multi-phase Pi-equivalent bear no descriptive text, with only the first 5 numbers of the card being printed out. Assuming conductor k,

1	2	3	4	5	6	7	8	9	10	11	12	13	14	15	16	17	18	19	20	21	22	23	24	25	26	27	28	29	30	31	32	33	34	35	36	37	38	39	40	41	42	43	44	45	46	47	48	49	50	51
E10.3					E10.3					E10.3					E10.3					E10.3																														
R _{k1}					L _{k1}					C _{k1}					R _{k2}					L _{k2}																														

The fourth and later conductors of course require continuation cards, since all parameters for row k can not be punched on a single card. For such cards, either 3 or 5 of the punched numbers are printed:

If the card has one triplet of numbers ($R_{k,m}$, $L_{k,m}$, $C_{k,m}$):

1	2	3	4	5	6	7	8	9	10	11	12	13	14	15	16	17	18	19	20	21	22	23	24	25	26	27	28	29	30	31	32	33	34	35	36	37	38	39	40	41	42	43	44	45	46	47	48	49	50	51
E10.3					E10.3					E10.3					E10.3					E10.3																														
R _{km}					L _{km}					C _{km}					R _{km}					L _{km}																														

If the card has two triplets, for columns m and m+1; or

If the card has 3 triplets, for columns m, m+1, m+2:

1	2	3	4	5	6	7	8	9	10	11	12	13	14	15	16	17	18	19	20	21	22	23	24	25	26	27	28	29	30	31	32	33	34	35	36	37	38	39	40	41	42	43	44	45	46	47	48	49	50	51
E10.3					E10.3					E10.3					E10.3					E10.3																														
R _{km}					L _{km}					C _{km}					R _{k,m+1}					L _{k,m+1}																														

Class 3 or Class 4 data is for the line-position (transposition) card, which is interpreted as follows:

1	2	3	4	5	6	7	8	9	10	11	12	13	14	15	16	17	18	19	20	21	22	23	24	25	26	27	28	29	30	31	32	33	34	35	36	37	38	39	40	41	42	43	44	45	46	47	48	49	50	51
LINE POS.										E11.3					I4	I4	I4	I4	I4	I4	I4																													
										DSECTJ					MULTIP	MSER	MBR	MSECT	MAPCAS ₁	MAPCAS ₂	MAPCAS ₃																													

5) Pi-equivalent (Section 1.23)

Here a distinction is made between the card for the first conductor of a Pi-equivalent and possible succeeding cards. The first card has the following interpretation:

1	2	3	4	5	6	7	8	9	10	11	12	13	14	15	16	17	18	19	20	21	22	23	24	25	26	27	28	29	30	31	32	33	34	35	36	37	38	39	40	41	42	43	44	45	46	47	48	49	50	51
1ST OF PI-CKT.											E11.3					E11.3					E11.3																													
											R ₁₁					L ₁₁					C ₁₁																													

The first card of succeeding conductors of a multi-phase Pi-equivalent bear no descriptive text, with only the first 5 numbers of the card being printed out. Assuming conductor k,

1	2	3	4	5	6	7	8	9	10	11	12	13	14	15	16	17	18	19	20	21	22	23	24	25	26	27	28	29	30	31	32	33	34	35	36	37	38	39	40	41	42	43	44	45	46	47	48	49	50	51
E10.3					E10.3					E10.3					E10.3					E10.3																														
R _{k1}					L _{k1}					C _{k1}					R _{k2}					L _{k2}																														

The fourth and later conductors of course require continuation cards, since all parameters for row k can not be punched on a single card. For such cards, either 3 or 5 of the punched numbers are printed:

If the card has one triplet of numbers ($R_{k,m}$, $L_{k,m}$, $C_{k,m}$):

1	2	3	4	5	6	7	8	9	10	11	12	13	14	15	16	17	18	19	20	21	22	23	24	25	26	27	28	29	30	31	32	33	34	35	36	37	38	39	40	41	42	43	44	45	46	47	48	49	50	51
E10.3					E10.3					E10.3					E10.3					E10.3																														
R _{km}					L _{km}					C _{km}					R _{km}					L _{km}																														

If the card has two triplets, for columns m and m+1; or

If the card has 3 triplets, for columns m, m+1, m+2:

1	2	3	4	5	6	7	8	9	10	11	12	13	14	15	16	17	18	19	20	21	22	23	24	25	26	27	28	29	30	31	32	33	34	35	36	37	38	39	40	41	42	43	44	45	46	47	48	49	50	51
E10.3					E10.3					E10.3					E10.3					E10.3																														
R _{km}					L _{km}					C _{km}					R _{k,m+1}					L _{k,m+1}																														

The user might rarely have occasion to employ the alternate formulation using matrices [A] and [B] in stead of the usual [R] and [L]. In this case, he will use the special formulation-change request records reading "USE AB" and "USE RL", which are interpreted as follows:

1	2	3	4	5	6	7	8	9	10	11	12	13	14	15	16	17	18	19	20	21	22	23	24	25	26	27	28	29	30	31	32	33	34	35	36	37	38	39	40	41	42	43	44	45	46	47	48	49	50	51
BEGIN COUPLED, LUMPED ELEMENTS USING (A), (B).																																													1					
BEGIN COUPLED, LUMPED ELEMENTS USING (R), (L).																																													1					

The preceding description assumes that the older, narrow formats are being used (SVINTAGE, 0). If instead the new, wider format is being used (SVINTAGE, 1), then any one data card only bears one triplet of numbers $R(k,m)$, $L(k,m)$, and $C(k,m)$. The first data card is interpreted no differently than with the narrow formats (see top of section, "1ST OF PI-CKT."):

1	2	3	4	5	6	7	8	9	10	11	12	13	14	15	16	17	18	19	20	21	22	23	24	25	26	27	28	29	30	31	32	33	34	35	36	37	38	39	40	41	42	43	44	45	46	47	48	49	50	51
1ST OF PI-CKT.										E11.3					E11.3					E11.3																														
										R ₁₁					L ₁₁					C ₁₁																														

But the second and later cards (if any; if two or more phases) use a unique format. Interpretation of the data card which begins a new row K of the matrix (for $K=2, 3, \dots$) is as follows:

1	2	3	4	5	6	7	8	9	10	11	12	13	14	15	16	17	18	19	20	21	22	23	24	25	26	27	28	29	30	31	32	33	34	35	36	37	38	39	40	41	42	43	44	45	46	47	48	49	50	51
PHASE 2										E13.4					E13.4					E13.4																														
K										R _{K1}					L _{K1}					C _{K1}																														

All other cards of the row (column M , for $M=2, 3, \dots$) are interpreted as follows:

1	2	3	4	5	6	7	8	9	10	11	12	13	14	15	16	17	18	19	20	21	22	23	24	25	26	27	28	29	30	31	32	33	34	35	36	37	38	39	40	41	42	43	44	45	46	47	48	49	50	51
CONT.										E13.4					E13.4					E13.4																														
										R _{KM}					L _{KM}					C _{KM}																														

⑥ Coupled R-L Branches in Phase Values (Section 1.24)

A distinction is made between the card for the first conductor of a coupled R-L group, and all succeeding cards. For the first-conductor card:

1	2	3	4	5	6	7	8	9	10	11	12	13	14	15	16	17	18	19	20	21	22	23	24	25	26	27	28	29	30	31	32	33	34	35	36	37	38	39	40	41	42	43	44	45	46	47	48	49	50	51
1ST OF COUPLED R-L.										E11.3					E11.3																																			
										R ₁₁					L ₁₁																																			

All succeeding cards simply have printout of the 1, 2, or 3 pairs of R-L punched on the card, in order of increasing column number. For the extreme case having three pairs in row k, columns m through m+2, the interpretation is:

1	2	3	4	5	6	7	8	9	10	11	12	13	14	15	16	17	18	19	20	21	22	23	24	25	26	27	28	29	30	31	32	33	34	35	36	37	38	39	40	41	42	43	44	45	46	47	48	49	50	51
E10.3					E10.3					E10.3					E10.3					E10.3																														
R _{k,m}					L _{k,m}					R _{k,m+1}					L _{k,m+1}					R _{k,m+2}																														

Should the user input zero and positive sequence values rather than the normal phase values, then interpretation of the 3 cards is as follows:

1. First card (with zero sequence values):

1	2	3	4	5	6	7	8	9	10	11	12	13	14	15	16	17	18	19	20	21	22	23	24	25	26	27	28	29	30	31	32	33	34	35	36	37	38	39	40	41	42	43	44	45	46	47	48	49	50	51
1ST OF COUPLED R-L.																								E11.3					E11.3																					
																								R ₀					L ₀																					

2. Second card (with positive-sequence values):

1	2	3	4	5	6	7	8	9	10	11	12	13	14	15	16	17	18	19	20	21	22	23	24	25	26	27	28	29	30	31	32	33	34	35	36	37	38	39	40	41	42	43	44	45	46	47	48	49	50	51
E10.3					E10.3					E10.3					E10.3					E10.3																														
R ₁					L ₁					0.0					0.0					0.0																														

3. The third card gives the third row of the matrices as if the input had been made in phase quantities; it gives the phase equivalent of the preceding sequence values:

1	2	3	4	5	6	7	8	9	10	11	12	13	14	15	16	17	18	19	20	21	22	23	24	25	26	27	28	29	30	31	32	33	34	35	36	37	38	39	40	41	42	43	44	45	46	47	48	49	50	51
E10.3					E10.3					E10.3					E10.3					E10.3																														
R _m					L _m					R _m					L _m					R _s																														

Just as with Pi-circuits of Section 1.23, it is possible to employ the alternate formulation using matrices [A] and [B] instead of the usual [R] and [L]. In this case, the user inputs special request records reading "USE AB" and "USE RL", which are interpreted as follows:

1	2	3	4	5	6	7	8	9	10	11	12	13	14	15	16	17	18	19	20	21	22	23	24	25	26	27	28	29	30	31	32	33	34	35	36	37	38	39	40	41	42	43	44	45	46	47	48	49	50	51
BEGIN COUPLED, LUMPED ELEMENTS USING (A), (B).																																																		1
BEGIN COUPLED, LUMPED ELEMENTS USING (R), (L).																																																		1

7 Saturable Transformer Component (Section 1.25)

The first card of a single-phase saturable transformer component bears the special request word "TRANSFORMER", which is interpreted as follows:

1	2	3	4	5	6	7	8	9	10	11	12	13	14	15	16	17	18	19	20	21	22	23	24	25	26	27	28	29	30	31	32	33	34	35	36	37	38	39	40	41	42	43	44	45	46	47	48	49	50	51
SAT. XFORMER.															E11.3					E11.3					E11.3					1																				
															i steady					ψ steady					Rmag					1																				

Actually, this interpretation assumes that the reference component feature has not been used to define this unit (i.e., field "BUS3" of cols. 15-20 are blank). If the reference component feature is being used, interpretation then consists of only the following:

1	2	3	4	5	6	7	8	9	10	11	12	13	14	15	16	17	18	19	20	21	22	23	24	25	26	27	28	29	30	31	32	33	34	35	36	37	38	39	40	41	42	43	44	45	46	47	48	49	50	51
TRANSFORMER COPY USING REFERENCE NAME																																			AG					1										
																																			BUS3															

Assuming no use of the reference component feature, the "TRANSFORMER" request card is followed by current-flux breakpoints (if any) which define the magnetization characteristic. Interpretation of all such records, if any, is as follows:

1	2	3	4	5	6	7	8	9	10	11	12	13	14	15	16	17	18	19	20	21	22	23	24	25	26	27	28	29	30	31	32	33	34	35	36	37	38	39	40	41	42	43	44	45	46	47	48	49	50	51
BREAKPOINT.															E15.5					E15.5																														
															Current					Flux																														

With no reference component usage, the preceding data class (whether present or absent) is terminated by a 9999-card, which is interpreted as follows:

1	2	3	4	5	6	7	8	9	10	11	12	13	14	15	16	17	18	19	20	21	22	23	24	25	26	27	28	29	30	31	32	33	34	35	36	37	38	39	40	41	42	43	44	45	46	47	48	49	50	51	
SPECIAL TERMINATION-OF-POINTS CARD.																																																			1

Next come the transformer winding cards, which are interpreted as follows assuming no usage of the reference-component capability:

1	2	3	4	5	6	7	8	9	10	11	12	13	14	15	16	17	18	19	20	21	22	23	24	25	26	27	28	29	30	31	32	33	34	35	36	37	38	39	40	41	42	43	44	45	46	47	48	49	50	51
WINDING I2										E12.4					E12.4					E12.4					1																									
										R _k					L _k					Volts					1																									
ITYPE																									1																									

If reference component usage were being employed for this unit, columns 14-49 of the above interpretation for a winding card would have been left blank. This is because the winding card in question bears no floating-point parameters in such a case.

Finally, if a 3-phase, 3-leg core-type transformer component is desired by the user, the three single-phase units for each phase are all preceded by the special 3-phase request card reading "TRANSFORMER THREE PHASE" (cols. 3-25 key-word text). Interpretation of such a card is as follows:

1	2	3	4	5	6	7	8	9	10	11	12	13	14	15	16	17	18	19	20	21	22	23	24	25	26	27	28	29	30	31	32	33	34	35	36	37	38	39	40	41	42	43	44	45	46	47	48	49	50	51
3-PHASE XFORMER REQUEST.																									A6		E12.4										1													
																									BUS3PH		R ₀										1													
																																					1													
																																					1													

8 Distributed-Parameter Transmission Line, Continuously-Transposed (Sect. 1.26)

The first two cards of a distributed-parameter line carry the zero and positive-sequence parameters respectively. Interpretation consists of 3 principal floating-point values read from the card, plus the characteristic impedance Z_0 (computed neglecting line loss) and the travel time τ :

1	2	3	4	5	6	7	8	9	10	11	12	13	14	15	16	17	18	19	20	21	22	23	24	25	26	27	28	29	30	31	32	33	34	35	36	37	38	39	40	41	42	43	44	45	46	47	48	49	50	51
E10.3					E10.3					E10.3					E10.3					E10.3					1																									
R'					A					B					$Z_0 = \sqrt{L/C}$					$\tau = 2\sqrt{LC}$					1																									

If the line is continuously transposed (Section 1.26), then the third and any later cards only define the terminal node names, and are therefore only interpreted by the message:

1	2	3	4	5	6	7	8	9	10	11	12	13	14	15	16	17	18	19	20	21	22	23	24	25	26	27	28	29	30	31	32	33	34	35	36	37	38	39	40	41	42	43	44	45	46	47	48	49	50	51
3RD OR LATER UNIF.-TRANPOSED DISTRIBUTED COND. 1																																																		

But if instead the component is a double-circuit distributed-parameter line with zero-sequence inter-circuit coupling (Section 1.26a), then interpretation of the third card is identical to the first two; in this case, the 3rd card has parameters for the "IL" mode. The fourth through sixth conductor cards then bear the following interpretation:

1	2	3	4	5	6	7	8	9	10	11	12	13	14	15	16	17	18	19	20	21	22	23	24	25	26	27	28	29	30	31	32	33	34	35	36	37	38	39	40	41	42	43	44	45	46	47	48	49	50	51
4TH OR LATER DOUBLE CKT DISTRIBUTED CONDUCTOR. 1																																																		

Should the first card (zero-sequence parameters) of a distributed-parameter transmission line carry a request for frequency-dependent representation (a "-1" punched in columns 53-54, field IPUNCH), the added data outlined in Section 1.26b must follow.

First, the miscellaneous data card bears the following interpretation:

1	2	3	4	5	6	7	8	9	10	11	12	13	14	15	16	17	18	19	20	21	22	23	24	25	26	27	28	29	30	31	32	33	34	35	36	37	38	39	40	41	42	43	44	45	46	47	48	49	50	51
FREQUENCY-DEPENDENCE MISC. DATA VALUES.																																																		

Then each card defining one or more points of the far-end (forward) weighting function $a_1(t)$ bears the identification

1	2	3	4	5	6	7	8	9	10	11	12	13	14	15	16	17	18	19	20	21	22	23	24	25	26	27	28	29	30	31	32	33	34	35	36	37	38	39	40	41	42	43	44	45	46	47	48	49	50	51
WEIGHTING FUNCTION A1 POINTS.																																																		

Finally, each card defining one or more points of the near-end (backward) weighting function $a_2(t)$ is interpreted as:

1	2	3	4	5	6	7	8	9	10	11	12	13	14	15	16	17	18	19	20	21	22	23	24	25	26	27	28	29	30	31	32	33	34	35	36	37	38	39	40	41	42	43	44	45	46	47	48	49	50	51
WEIGHTING FUNCTION A2 POINTS.																																						F12.8												
																																						Area												

Here the field AREA (cols. 38-49) only applies to the last card defining $a_2(t)$, where the total area under the weighting functions, $AREA = \int_0^{\infty} a_1(t)dt + \int_0^{\infty} a_2(t)dt$ is printed out. For valid weighting functions, this should be near unity (like 1.005).

An exception to this complete display occurs if variable LIST (columns 57-64 of the frequency-dependence miscellaneous data card) is punched equal to unity rather than zero. Then none of the $A_1(t)$ data cards is displayed or interpreted, and only the final two $A_2(t)$ cards are shown. The interpretation of these final two data cards is exactly as they would appear if LIST were zero.

9 Recursive Convolution Frequency Dependence (Section 1.27)

A frequency-dependent untransposed transmission line uses data cards as documented in Section 1.27. Typically these will be generated by the EMTP itself, using either the "SEMLYEN SETUP" feature of Section 7.5, or the "HAUER SETUP" feature of Section 7.8. Interpretation begins with the branch card of Rule 1; for phase (mode) K, one has:

1	2	3	4	5	6	7	8	9	10	11	12	13	14	15	16	17	18	19	20	21	22	23	24	25	26	27	28	29	30	31	32	33	34	35	36	37	38	39	40	41	42	43	44	45	46	47	48	49	50	51
CONVOLUTION.													E13.4											E13.4											I4						I4									
													Y0											Y											N1						N2									

Immediately after such a branch (mode) card comes the steady-state card of modal impedances, to be used during the phasor solution for initial conditions. Interpretation is as follows:

1	2	3	4	5	6	7	8	9	10	11	12	13	14	15	16	17	18	19	20	21	22	23	24	25	26	27	28	29	30	31	32	33	34	35	36	37	38	39	40	41	42	43	44	45	46	47	48	49	50	51
PHASOR Z, Y.											E12.4					E12.4					E12.4																													
											R					ωL					G																													

Next comes an indeterminate number of data cards which characterize the modal wave propagation. The exponentials are numbered 1, 2, 3, etc., with any one data card typically bearing two consecutive ones of these. That is, card one bears the first two exponentials, card two bears exponentials 3 and 4, etc. Interpretation for the data card bearing exponentials K through M is as follows:

1	2	3	4	5	6	7	8	9	10	11	12	13	14	15	16	17	18	19	20	21	22	23	24	25	26	27	28	29	30	31	32	33	34	35	36	37	38	39	40	41	42	43	44	45	46	47	48	49	50	51
PROPAGATION EXP.																	3		-2		E12.3					E12.3																								
																	K		M		VOLT ₁					VOLT ₂																								

After the last data card of propagation exponentials for the mode, we have one or more such cards for the admittance exponentials. Just as with the propagation exponentials, there are typically two per card. Interpretation is comparable, too:

1	2	3	4	5	6	7	8	9	10	11	12	13	14	15	16	17	18	19	20	21	22	23	24	25	26	27	28	29	30	31	32	33	34	35	36	37	38	39	40	41	42	43	44	45	46	47	48	49	50	51
ADMITTANCE EXP.																	-		E12.3					E12.3																										
																	K		M		VOLT ₁					VOLT ₂																								

So much for the two components of Rule 3 data. Such data (Rules 1, 2, and 3) are cyclically repeated for each branch (mode) of the multi-phase transmission circuit (see Rule 4). After the last such mode, we have data cards which specify the voltage transformation matrix [TV] of Rule 5. This is inputted by rows, from left to right within a row, with 3 matrix elements on any one data card. For one of the data cards of row K of the matrix, interpretation is as follows:

1	2	3	4	5	6	7	8	9	10	11	12	13	14	15	16	17	18	19	20	21	22	23	24	25	26	27	28	29	30	31	32	33	34	35	36	37	38	39	40	41	42	43	44	45	46	47	48	49	50	51
[TV] ROW 3											E12.3					E12.3					E12.3																													
K											TV _{K,1} ^R					TV _{K,1} ^I					TV _{K,2} ^R																													

10a

Type-94 Surge Arrester

Section 1.38 describes the various data cards which are associated with the Type-94 modern-style silicon-carbide surge arrester component (with current limiting gap). These begin with a branch card, which is interpreted as follows (assuming no reference-branch usage):

1	2	3	4	5	6	7	8	9	10	11	12	13	14	15	16	17	18	19	20	21	22	23	24	25	26	27	28	29	30	31	32	33	34	35	36	37	38	39	40	41	42	43	44	45	46	47	48	49	50	51
TYPE-94 ARRESTER.																	E10.3					E11.4					E11.4					1																		
																	V _{flash}					F _v					F _i					1																		
																																1																		
																																1																		

Then come six cards bearing floating-point parameters of the arrester --- three numbers on each of the first five cards, and two on the final one. These cards are interpreted in the following way:

1	2	3	4	5	6	7	8	9	10	11	12	13	14	15	16	17	18	19	20	21	22	23	24	25	26	27	28	29	30	31	32	33	34	35	36	37	38	39	40	41	42	43	44	45	46	47	48	49	50	51
CONSTS.											12	-	12	.	E11.3					E11.3					E11.3					1																				
											L		M		CCHAR(L)					CCHAR(L+1)					CCHAR(M)					1																				
																														1																				

Here "L" and "M" are beginning and ending indices for the FORTRAN EMTP storage of the constants on the card. For the six cards, these indices should read as follows:

Card #	1	2	3	4	5	6
L	1	5	8	11	14	17
M	3	7	10	13	16	18

If the reference-branch procedure were used (fields "BUS3" and "BUS4" of columns 15-26 not both blank), then only one card would be involved, and this would be interpreted as per Point 11.

10b

Multi-phase ZnO surge arresters

Section 1.32 describes the various data cards which are associated with multi-phase, compensation-based, ZnO surge arrester modeling. These begin with the definition of a subtype of type 92 nonlinear resistance. This first data card bears the following interpretation:

1	2	3	4	5	6	7	8	9	10	11	12	13	14	15	16	17	18	19	20	21	22	23	24	25	26	27	28	29	30	31	32	33	34	35	36	37	38	39	40	41	42	43	44	45	46	47	48	49	50	51
GAP, TYPE 92.																	E11.3					E11.3					E11.3					1																		
																	0.0					0.0					ZnO-CODE					1																		

10C

Branch Element Types 91-93 and 96-99.

For purposes of documenting the interpretation, it is convenient to lump together all remaining nonlinear and pseudo-nonlinear elements. These have type codes 91, 92, 93, 96, 97, 98, and 99, as described in Sections 1.28 onward.

Definition of each of these elements begins with a first data card which specifies the terminal node names, among other things. Assuming no usage of the reference branch procedure, interpretations are as follows:

1. Pseudo-nonlinear R, type 99 (Section 1.28)

1	2	3	4	5	6	7	8	9	10	11	12	13	14	15	16	17	18	19	20	21	22	23	24	25	26	27	28	29	30	31	32	33	34	35	36	37	38	39	40	41	42	43	44	45	46	47	48	49	50	51
TYPE-99 NONLINEAR R.																								E11.3						E11.3						I5					1									
																								V _{flash}						T _{delay}						JUMP					1									

2. Pseudo-nonlinear L, type 98 (Section 1.29)

1	2	3	4	5	6	7	8	9	10	11	12	13	14	15	16	17	18	19	20	21	22	23	24	25	26	27	28	29	30	31	32	33	34	35	36	37	38	39	40	41	42	43	44	45	46	47	48	49	50	51
TYPE-98 PSEUDO-NONLINEAR L.																								E11.3						E11.3						1														
																								i _{steady}						ψ _{steady}						1														

3. Staircase time-varying R, type 97 (Section 1.30)

1	2	3	4	5	6	7	8	9	10	11	12	13	14	15	16	17	18	19	20	21	22	23	24	25	26	27	28	29	30	31	32	33	34	35	36	37	38	39	40	41	42	43	44	45	46	47	48	49	50	51
TYPE-97 R(T).																								E12.4						E12.4						1														
																								V _{flash}						T _{delay}						1														

4. Pseudo-nonlinear hysteretic reactor, Type 96 (Section 1.31)

1	2	3	4	5	6	7	8	9	10	11	12	13	14	15	16	17	18	19	20	21	22	23	24	25	26	27	28	29	30	31	32	33	34	35	36	37	38	39	40	41	42	43	44	45	46	47	48	49	50	51
HYSTERESIS.												E12.4						E12.4						E12.4					1																					
												i _{steady}						ψ _{steady}						ψ _{resid}					1																					

5. Time-varying R, type 91 (Section 1.35)

1	2	3	4	5	6	7	8	9	10	11	12	13	14	15	16	17	18	19	20	21	22	23	24	25	26	27	28	29	30	31	32	33	34	35	36	37	38	39	40	41	42	43	44	45	46	47	48	49	50	51
TIME VARYING R. TYPE 91.																											E11.3						E11.3																	
																											0.0						R-CODE																	

The above card is followed by a single card specifying the starting (breakdown) voltage VSTART. This card bears the following interpretation:

1	2	3	4	5	6	7	8	9	10	11	12	13	14	15	16	17	18	19	20	21	22	23	24	25	26	27	28	29	30	31	32	33	34	35	36	37	38	39	40	41	42	43	44	45	46	47	48	49	50	51
V START =										E15.5																																								
										VSTART																																								

The actual characteristic $R = f(t_R)$ is specified on an indeterminate number of cards. Each of these cards bears the following interpretation:

1	2	3	4	5	6	7	8	9	10	11	12	13	14	15	16	17	18	19	20	21	22	23	24	25	26	27	28	29	30	31	32	33	34	35	36	37	38	39	40	41	42	43	44	45	46	47	48	49	50	51
BREAKPOINT															E11.4						E11.4																													
															R(t _R)						t _R																													

The specification of the resistance values is terminated by a 9999-card which bears the following interpretation:

1	2	3	4	5	6	7	8	9	10	11	12	13	14	15	16	17	18	19	20	21	22	23	24	25	26	27	28	29	30	31	32	33	34	35	36	37	38	39	40	41	42	43	44	45	46	47	48	49	50	51
SPECIAL TERMINATION-OF-POINTS CARD.																																																		

6. Piecewise-linear, continuous R, type 92 (Section 1.36)

1	2	3	4	5	6	7	8	9	10	11	12	13	14	15	16	17	18	19	20	21	22	23	24	25	26	27	28	29	30	31	32	33	34	35	36	37	38	39	40	41	42	43	44	45	46	47	48	49	50	51
GAP, TYPE 92.															E11.3						E11.3						E11.3																							
															0.0						0.0						R-code																							

Then follows a single card specifying general resistor data which bears the following interpretation:

45a-3

1	2	3	4	5	6	7	8	9	10	11	12	13	14	15	16	17	18	19	20	21	22	23	24	25	26	27	28	29	30	31	32	33	34	35	36	37	38	39	40	41	42	43	44	45	46	47	48	49	50	51
RLIN,VFLASH,NFLASH																			E10.5									E10.5									E10.5													
																			RLIN									VFLASH									NFLASH													

The actual resistor characteristic will follow the above card. There can be any number of cards with each of them bearing the following interpretation:

1	2	3	4	5	6	7	8	9	10	11	12	13	14	15	16	17	18	19	20	21	22	23	24	25	26	27	28	29	30	31	32	33	34	35	36	37	38	39	40	41	42	43	44	45	46	47	48	49	50	51
BREAKPOINT																			E11.4									E11.4																						
																			CUR									VOLT																						

The indeterminate number of characteristic cards is terminated with a 9999-card which bears the following interpretation:

1	2	3	4	5	6	7	8	9	10	11	12	13	14	15	16	17	18	19	20	21	22	23	24	25	26	27	28	29	30	31	32	33	34	35	36	37	38	39	40	41	42	43	44	45	46	47	48	49	50	51
SPECIAL TERMINATION-OF-POINTS CARD.																																																		

11) Branches using the Reference-Branch Idea

When the reference-branch concept is used, fields BUS3 and BUS4 (columns 15-26 of data card) carry the node names of the preceding branch which is being referred to. The first card of a coupled group using this capability bears the following interpretation:

1	2	3	4	5	6	7	8	9	10	11	12	13	14	15	16	17	18	19	20	21	22	23	24	25	26	27	28	29	30	31	32	33	34	35	36	37	38	39	40	41	42	43	44	45	46	47	48	49	50	51
REFERENCE BRANCH.															COPY										AG					TO					AG															
																									BUS3					BUS4																				

All later branches of the coupled group (if any) bear the following abbreviated interpretation

1	2	3	4	5	6	7	8	9	10	11	12	13	14	15	16	17	18	19	20	21	22	23	24	25	26	27	28	29	30	31	32	33	34	35	36	37	38	39	40	41	42	43	44	45	46	47	48	49	50	51
REFERENCE BRANCH.															COPY CONT.																																			

12) Switches and Switched Elements (Section 1.4)

The "ordinary" switches of Section 1.40 are EMTP switch components which have no linear resistance or inductance element associated with them, and which are not valves, diodes, or TACS-controlled. Generally these switches are of type-code zero (as punched in columns 1-2), although type-code '76' is also possible for a Class 3a switch. Ordinary switches come in five classes, with the first four interpreted as per the following format:

1	2	3	4	5	6	7	8	9	10	11	12	13	14	15	16	17	18	19	20	21	22	23	24	25	26	27	28	29	30	31	32	33	34	35	36	37	38	39	40	41	42	43	44	45	46	47	48	49	50	51
SWITCH.									E10.2					E10.2					E10.2					E10.2																										
Class 1:									T_{close}					T_{open}					I_e					—																										
Class 2:									T_{close}					T_{delay}					I_e					V_{flash}																										
Class 3a									\bar{T} or \bar{T}_B					ϵ or ϵ_B					—					—																										
Class 3b independent									T_{mid} or T_{beg}					ΔT					NSTEP					—																										
Class 3b dependent									T_{offset}^B					—					—					—																										

The final one, for Class 4 switches ("MEASURING" switches), bears the following interpretation:

1	2	3	4	5	6	7	8	9	10	11	12	13	14	15	16	17	18	19	20	21	22	23	24	25	26	27	28	29	30	31	32	33	34	35	36	37	38	39	40	41	42	43	44	45	46	47	48	49	50	51
PERMANENTLY CLOSED SWITCH USED FOR METERING.																																																		1

Next, switched inductance elements of Section 1.41 carry the interpretation:

1	2	3	4	5	6	7	8	9	10	11	12	13	14	15	16	17	18	19	20	21	22	23	24	25	26	27	28	29	30	31	32	33	34	35	36	37	38	39	40	41	42	43	44	45	46	47	48	49	50	51
SWITCHED L.					E12.4										E12.4										E12.4																									
					L ₁										L ₂										Ψ _s																									

For switched resistance elements of Section 1.42, the following interpretation is provided:

1	2	3	4	5	6	7	8	9	10	11	12	13	14	15	16	17	18	19	20	21	22	23	24	25	26	27	28	29	30	31	32	33	34	35	36	37	38	39	40	41	42	43	44	45	46	47	48	49	50	51
SWITCHED R.					E12.4										E12.4										E12.4																									
					R										V _{seal}										V _{breakdown}																									

For diode or TACS-controlled valve operation, the type-11 switch of Section 1.43 is used.

- Parameter "GRID" is read from the A6 field in columns 65 - 70 .
- Parameter "CLAMP" is read from the A6 field in columns 71 - 76 .

For diode or TACS-controlled valve operation, the type-12 switch of Section 1.44 is used.

- Parameter "SPARK" is read from the A6 field in columns 65 - 70 .
- Parameter "CLAMP" is read from the A6 field in columns 71 - 76 .

For simple TACS-controlled switch operation, the type-13 switch of Section 1.45 is used.

- Parameter "SIGNAL" is read from the A6 field in columns 71 - 76 .

Interpretation is as follows:

1	2	3	4	5	6	7	8	9	10	11	12	13	14	15	16	17	18	19	20	21	22	23	24	25	26	27	28	29	30	31	32	33	34	35	36	37	38	39	40	41	42	43	44	45	46	47	48	49	50	51	52	53	54	55	56	57	58	59	60	61	62	63	64	65	66	67	68
DIODE, NO TACS GRID					VALVE, TACS GRID =										GAP, NO TACS SPARK										GAP, TACS SPARK =						SWITCH, TACS CONTROL SIGNAL =																																				
																									TACS CLAMP =																																										

13 Sources (Section 1.6)

Source cards are interpreted as follows, for sources Type 1-15 :

1	2	3	4	5	6	7	8	9	10	11	12	13	14	15	16	17	18	19	20	21	22	23	24	25	26	27	28	29	30	31	32	33	34	35	36	37	38	39	40	41	42	43	44	45	46	47	48	49	50	51
SOURCE.				E10.2					E10.2					E10.2					E10.2																															
				AMPL					f; α					T ₀ ; φ ₀ ; ε					T _{start}																															

For type-16 DC-simulator sources, the first card is interpreted as:

1	2	3	4	5	6	7	8	9	10	11	12	13	14	15	16	17	18	19	20	21	22	23	24	25	26	27	28	29	30	31	32	33	34	35	36	37	38	39	40	41	42	43	44	45	46	47	48	49	50	51
SOURCE.				E10.2					E10.2					E10.2					E10.2																															
				K					θ _{init} ; λ _{set}					T ₁					λ _{initial}																															

The second and final card then bears only the label:

1	2	3	4	5	6	7	8	9	10	11	12	13	14	15	16	17	18	19	20	21	22	23	24	25	26	27	28	29	30	31	32	33	34	35	36	37	38	39	40	41	42	43	44	45	46	47	48	49	50	51
SECOND DC SIMULATOR CARD.																																																		

The Type-17 EMTP source component provides for representation of a zinc-oxide surge arrester that has constraint equation $i = A * (v/v_{ref})^G$. Interpretation is as follows:

1	2	3	4	5	6	7	8	9	10	11	12	13	14	15	16	17	18	19	20	21	22	23	24	25	26	27	28	29	30	31	32	33	34	35	36	37	38	39	40	41	42	43	44	45	46	47	48	49	50	51
SOURCE.				E10.2					E10.2					E10.2					E10.2																															
				A					G					v _{ref}					=																															

Type 1-10 sources have the functions f(t) read in off cards in point-by-point fashion, as the transient solution progresses. Assuming that the user is printing out solution results, the input card images may be periodically separated by such printed output. In any case, the interpretation of the source cards of type 1-10 is as follows:

1	2	3	4	5	6	7	8	9	10	11	12	13	14	15	16	17	18	19	20	21	22	23	24	25	26	27	28	29	30	31	32	33	34	35	36	37	38	39	40	41	42	43	44	45	46	47	48	49	50	51
ANOTHER INPUT CARD FOR TYPE 1-10 SOURCES.																																																		

If all such source definitions are to terminate before the last time step of the EMTP simulation, then a bounding record with "9999" punched in columns 5-8 is to be used. This last card then bears the added column 45-48 interpretation as shown at the right.

42	43	44	45	46	47	48	49	50	51
END.							1		

Data input for dynamic synchronous machine (S.M.) EMTF source components is described in Section 1.62 . The type-code which is punched in columns 1-2 will be equal to 50 or 59 , in this case. Each dynamic S.M. requires a number of data cards, the interpretation of which shall now be described in order of data input.

The S.M. cards begin with Class 1 data, for which there are three cards — one for each armature connection. The first of these is interpreted as follows:

1	2	3	4	5	6	7	8	9	10	11	12	13	14	15	16	17	18	19	20	21	22	23	24	25	26	27	28	29	30	31	32	33	34	35	36	37	38	39	40	41	42	43	44	45	46	47	48	49	50	51
SOURCE.									E10.2					E10.2					E10.2					E10.2					1																					
									VOLT					FREQ					ANGLE					=					1																					
																													1																					
																													1																					

The second Class 1 card bears the interpretation:

1	2	3	4	5	6	7	8	9	10	11	12	13	14	15	16	17	18	19	20	21	22	23	24	25	26	27	28	29	30	31	32	33	34	35	36	37	38	39	40	41	42	43	44	45	46	47	48	49	50	51
2ND PHASE OF S.M.																		E12.5					- F8.2					1																						
																		VOLT					- ANGLE					1																						
																												1																						
																												1																						

Here the printed angle is in degrees.

Class 1 data is then finished by a comparable interpretation for the third card (which is for phase "c"):

1	2	3	4	5	6	7	8	9	10	11	12	13	14	15	16	17	18	19	20	21	22	23	24	25	26	27	28	29	30	31	32	33	34	35	36	37	38	39	40	41	42	43	44	45	46	47	48	49	50	51
3RD PHASE OF S.M.																		E12.5					- F8.2					1																						
																		VOLT					- ANGLE					1																						
																												1																						
																												1																						

Class 2 S.M. data (if it exists) consists of up to three optional special-request cards, of which the order is immaterial. One of these represents a request for a delta connection of the S.M. armature windings. Interpretation of this record which bears the key-word text "DELTA CONNECTION" is as follows:

1	2	3	4	5	6	7	8	9	10	11	12	13	14	15	16	17	18	19	20	21	22	23	24	25	26	27	28	29	30	31	32	33	34	35	36	37	38	39	40	41	42	43	44	45	46	47	48	49	50	51
NOTIFICATION OF DELTA-CONNECTED ARMATURE.																																																		1

The second optional special-request card is used to redefine one or more tolerances or iteration limits which are used in the S.M. solution process. Interpretation of this record which bears the key-word text "TOLERANCES" is as follows:

The remaining cards of Class 3 S.M. data depend upon whether standard manufacturer-supplied data are being used. If so (if the machine has type code 50 or 51), then two additional cards which are interpreted as follows complete the Class 2 data:

1	2	3	4	5	6	7	8	9	10	11	12	13	14	15	16	17	18	19	20	21	22	23	24	25	26	27	28	29	30	31	32	33	34	35	36	37	38	39	40	41	42	43	44	45	46	47	48	49	50	51
5TH S.M. CARD.																	F10.4					F10.4					F10.4					1																		
																	R_a					X_l					X_d					1																		
																																1																		
																																1																		

1	2	3	4	5	6	7	8	9	10	11	12	13	14	15	16	17	18	19	20	21	22	23	24	25	26	27	28	29	30	31	32	33	34	35	36	37	38	39	40	41	42	43	44	45	46	47	48	49	50	51
6TH S.M. CARD.																	F10.4					F10.4					F10.4					1																		
																	T_{do}^v					T_{go}^v					T_{jo}^v					1																		
																																1																		
																																1																		

On the other hand, should the user have chosen to describe the machine by means of per unit inductance and resistance matrices (type codes 52 or 53), then the Class 2 S.M. data is completed with three cards which are interpreted as follows:

1	2	3	4	5	6	7	8	9	10	11	12	13	14	15	16	17	18	19	20	21	22	23	24	25	26	27	28	29	30	31	32	33	34	35	36	37	38	39	40	41	42	43	44	45	46	47	48	49	50	51
5TH S.M. CARD.																	F10.4					F10.4					F10.4					1																		
																	L_f					L_{kf}					L_{fkj}					1																		
																																1																		
																																1																		

1	2	3	4	5	6	7	8	9	10	11	12	13	14	15	16	17	18	19	20	21	22	23	24	25	26	27	28	29	30	31	32	33	34	35	36	37	38	39	40	41	42	43	44	45	46	47	48	49	50	51
6TH S.M. CARD.																	F10.4					F10.4					F10.4					1																		
																	L_g					L_{kg}					L_{gkj}					1																		
																																1																		
																																1																		

1	2	3	4	5	6	7	8	9	10	11	12	13	14	15	16	17	18	19	20	21	22	23	24	25	26	27	28	29	30	31	32	33	34	35	36	37	38	39	40	41	42	43	44	45	46	47	48	49	50	51
7TH S.M. CARD.																	F10.4					F10.4					F10.4					1																		
																	X_o					R_a					R_f					1																		
																																1																		
																																1																		

Such triplets of machine-specifications continue until they are terminated by a blank card, which is interpreted as follows:

1	2	3	4	5	6	7	8	9	10	11	12	13	14	15	16	17	18	19	20	21	22	23	24	25	26	27	28	29	30	31	32	33	34	35	36	37	38	39	40	41	42	43	44	45	46	47	48	49	50	51
BLANK CARD ENDING MACHINE TABLE.																																																		1

Then come the coil cards, one for each coil of all U.M. components, in order. Using the abbreviation IO = CURTOUT for the output request flag, interpretation of the card for coil KK is as follows:

1	2	3	4	5	6	7	8	9	10	11	12	13	14	15	16	17	18	19	20	21	22	23	24	25	26	27	28	29	30	31	32	33	34	35	36	37	38	39	40	41	42	43	44	45	46	47	48	49	50	51
COIL I4.				E14.5										E14.5										I5							1																			
KK				RESIS										LLEAK										IO							1																			

The last such U.M. coil card is followed by a terminating blank card, which is interpreted as follows. This completes the U.M. data input, and control returns to "OVER5" source input.

1	2	3	4	5	6	7	8	9	10	11	12	13	14	15	16	17	18	19	20	21	22	23	24	25	26	27	28	29	30	31	32	33	34	35	36	37	38	39	40	41	42	43	44	45	46	47	48	49	50	51
BLANK CARD ENDING COIL TABLE.																																																		

14 Over-riding Initial Conditions (Section 1.7)

Because the initial-condition capability of the EMTP is far from complete, the explanation provided here shall likewise amount to little more than a documentation of those initial condition cards which are honored.

First, there are the original three classes of initial condition input, as per the subdivisions under Point b) of Section 1.7. These are node voltages, linear branches, and nonlinear branches (type code ID = 2, 3, and 4, respectively):

Cards for inputting node voltages come first (with "2" punched in columns 1-2, field ID), and are interpreted as follows. Only the first such card actually has the third field (frequency f) actually printed.

1	2	3	4	5	6	7	8	9	10	11	12	13	14	15	16	17	18	19	20	21	22	23	24	25	26	27	28	29	30	31	32	33	34	35	36	37	38	39	40	41	42	43	44	45	46	47	48	49	50	51
NODE VOLT INIT COND.										E11.3										E11.3										F7.1																				
										Re{E}										Im{E}										f																				

Next come the cards specifying currents in linear branches, with ID of 3. For lumped series R-L-C, or for Pi-equivalents, the interpretation is as follows:

1	2	3	4	5	6	7	8	9	10	11	12	13	14	15	16	17	18	19	20	21	22	23	24	25	26	27	28	29	30	31	32	33	34	35	36	37	38	39	40	41	42	43	44	45	46	47	48	49	50	51
LINEAR I.										E12.4										E12.4										E12.4																				
										A										B										C																				

For distributed-parameter branches, the program prints the following for the 2nd and later conductors, if any; the first is interpreted as a "LINEAR I." card as documented immediately above.

1	2	3	4	5	6	7	8	9	10	11	12	13	14	15	16	17	18	19	20	21	22	23	24	25	26	27	28	29	30	31	32	33	34	35	36	37	38	39	40	41	42	43	44	45	46	47	48	49	50	51
DISTRIB. I.										E12.4					E12.4					E12.4																														
										Re {I _k }					Im {I _k }					Re {I _m }																														

Finally, there is the interpretation of the cards for nonlinear and time-varying branches (ID of 4, punched in columns 1-2 of the card):

1	2	3	4	5	6	7	8	9	10	11	12	13	14	15	16	17	18	19	20	21	22	23	24	25	26	27	28	29	30	31	32	33	34	35	36	37	38	39	40	41	42	43	44	45	46	47	48	49	50	51
NONLIN. BRANCH INIT COND.										E11.3					E11.3																																			
										I _{km}					Ψ _{km}																																			

The Type-96 hysteretic inductor is an exception to this general rule for nonlinear elements in that there are two additional cards which follow the initial one just described. Call these cards 2 and 3. Card 2 is punched with two integers and four floating point numbers, reading from left to right. The integers and first two floating point numbers appear in the interpretation of card 2:

1	2	3	4	5	6	7	8	9	10	11	12	13	14	15	16	17	18	19	20	21	22	23	24	25	26	27	28	29	30	31	32	33	34	35	36	37	38	39	40	41	42	43	44	45	46	47	48	49	50	51
TYPE-96.										I4		I4		E15.6					E15.6																															
										M5		VCHAR(N16)					VCHAR(N17-1)																																	

Card 3 is punched with one integer and four floating point numbers; the integer and first two floating-point numbers are part of the interpretation, which appears as follows:

1	2	3	4	5	6	7	8	9	10	11	12	13	14	15	16	17	18	19	20	21	22	23	24	25	26	27	28	29	30	31	32	33	34	35	36	37	38	39	40	41	42	43	44	45	46	47	48	49	50	51
TYPE-96.										I8		E15.6					E15.6																																	
										N20		VCHAR(N18)					VCHAR(N19)																																	

No further explanation of this Type-96 hysteretic inductor shall be provided, since such initial conditions should always be EMTP-punched rather than user-punched, and understanding is not actually required.

In the case of EMTP-punched terminal conditions which are re-used as EMTP initial conditions, there also is an extra class of cards (in addition to those listed above), for switches. There is one such card for each switch, with type code ID = 5. Each such card carries two bus names (2A6 format, to identify switch), three integers (3I4), and four floating-point variables (4E13.6). Interpretation only uses the first three integers and the first floating-point variable:

1	2	3	4	5	6	7	8	9	10	11	12	13	14	15	16	17	18	19	20	21	22	23	24	25	26	27	28	29	30	31	32	33	34	35	36	37	38	39	40	41	42	43	44	45	46	47	48	49	50	51
SWITCH INIT. COND.																		IG				IG				IG				E 13.4																				
																		N1				N2				N3				D1																				

15 Output Specification Cards (Section 1.8)

Solution node voltages which are to be printed or plotted as functions of time are defined on one or more cards as per Section 1.8a. If the user requests all node voltage outputs by means of a 1-punch in column 2, the interpretation is:

1	2	3	4	5	6	7	8	9	10	11	12	13	14	15	16	17	18	19	20	21	22	23	24	25	26	27	28	29	30	31	32	33	34	35	36	37
REQUEST FOR OUTPUT OF ALL NODE VOLTAGE																																				

But for the usual case of selective voltage output, each card is interpreted by:

1	2	3	4	5	6	7	8	9	10	11	12	13	14	15	16	17	18	19	20	21	22	23	24	25	26	27	28	29	30	31	32	33	34	35	36	37
CARD OF BUS NAMES FOR NODE-VOLTAGE OUTPUT.																																				

The preceding records were for deterministic (i.e., non-statistical) data cases, in accord with Section 1.8a. But for a "STATISTICS" data case, the separate, special specification of Section 1.8b applies. Here only selective output requests are allowed. Depending upon whether node voltage or voltage difference ("branch voltage" for short) outputs are being requested, interpretation is as per one of the following:

Node voltage requests, "STATISTICS"

1	2	3	4	5	6	7	8	9	10	11	12	13	14	15	16	17	18	19	20	21	22	23	24	25	26	27	28	29	30	31	32	33	34	35	36	37	38	39	40	41	42	43	44	45	46	47	48	49	50	51
STATISTICAL OUTPUT OF NODE VOLTAGES.																																						E11.3												
BASEV																																																		

Voltage-difference requests, "STATISTICS"

1	2	3	4	5	6	7	8	9	10	11	12	13	14	15	16	17	18	19	20	21	22	23	24	25	26	27	28	29	30	31	32	33	34	35	36	37	38	39	40	41	42	43	44	45	46	47	48	49	50	51
STATISTICAL OUTPUT OF BRANCH VOLTAGES.																																						E11.3												
BASEV																																																		

① Cards for Batch-Mode Plotting (Section 1.10)

The card of 78-character case-title text, Point 1 of Section 1.10-B, is interpreted as follows:

1	2	3	4	5	6	7	8	9	10	11	12	13	14	15	16	17	18	19	20	21	22	23	24	25	26	27	28	29	30	31	32	33	34	35	36	37	38	39	40	41	42	43	44	45	46	47	48	49	50	51
PLOT CASE-TITLE TEXT.																																																		1

Cards defining the graph subtitle text of Point 2 are interpreted as follows, assuming that the user has not attempted to input more than the limit of four for any one plot:

1	2	3	4	5	6	7	8	9	10	11	12	13	14	15	16	17	18	19	20	21	22	23	24	25	26	27	28	29	30	31	32	33	34	35	36	37	38	39	40	41	42	43	44	45	46	47	48	49	50	51
PLOT SUBTITLE CARD.																																																		1

Excess graph subtitle-text cards (in excess of four) are simply ignored by the EMTP; they are given the following interpretation:

1	2	3	4	5	6	7	8	9	10	11	12	13	14	15	16	17	18	19	20	21	22	23	24	25	26	27	28	29	30	31	32	33	34	35	36	37	38	39	40	41	42	43	44	45	46	47	48	49	50	51
OVERFLOW SUBTITLE CARD DISCARDED																																																		1

A plot specification card of Point 3 is interpreted as follows:

1	2	3	4	5	6	7	8	9	10	11	12	13	14	15	16	17	18	19	20	21	22	23	24	25	26	27	28	29	30	31	32	33	34	35	36	37	38	39	40	41	42	43	44	45	46	47	48	49	50	51
** PLOT CARD.																E11.3											E11.3											E11.3												
																HPI											HMIN											HMAX												

The extra "continuation card" of Point 4, for the input of 3 or 4 branch-variable node-pair identifications (six or eight node names), is interpreted as follows:

1	2	3	4	5	6	7	8	9	10	11	12	13	14	15	16	17	18	19	20	21	22	23	24	25	26	27	28	29	30	31	32	33	34	35	36	37	38	39	40	41	42	43	44	45	46	47	48	49	50	51
CONTINUATION TO READ BRANCH NODE-PAIR NAMES.																																																		1

The extra "continuation card" of Point 5, for re-reading of the five floating-point parameters of the plot-specification card using 5E16.0 format, is interpreted as follows:

1	2	3	4	5	6	7	8	9	10	11	12	13	14	15	16	17	18	19	20	21	22	23	24	25	26	27	28	29	30	31	32	33	34	35	36	37	38	39	40	41	42	43	44	45	46	47	48	49	50	51
RE-READ OF FLOATING-POINT FIELDS FOR ACCURACY.																																																		1

The card for Calcomp graph-size adjustment, bearing key word "HEIGHT" in columns 25-30 as per Point 6, is interpreted as follows:

1	2	3	4	5	6	7	8	9	10	11	12	13	14	15	16	17	18	19	20	21	22	23	24	25	26	27	28	29	30	31	32	33	34	35	36	37	38	39	40	41	42	43	44	45	46	47	48	49	50	51
GRAPH SIZE ADJUSTMENT CARD.																								E11.3						E11.3																				
																								BEGIN						SPAN																				

The card for Calcomp graph-separation adjustment, with key word "MARGIN" in columns 25-30 as per Point 7, is interpreted as follows:

1	2	3	4	5	6	7	8	9	10	11	12	13	14	15	16	17	18	19	20	21	22	23	24	25	26	27	28	29	30	31	32	33	34	35	36	37	38	39	40	41	42	43	44	45	46	47	48	49	50	51
GRAPH SEPARATION CARD.																								KSEP						13																				
																								KSEP																										

The card for redefinition of the smoothing tolerance "EPS", bearing key word "SMOOTH" in columns 25-30 as per Point 8, is interpreted as follows:

1	2	3	4	5	6	7	8	9	10	11	12	13	14	15	16	17	18	19	20	21	22	23	24	25	26	27	28	29	30	31	32	33	34	35	36	37	38	39	40	41	42	43	44	45	46	47	48	49	50	51
REDEFINITION OF SMOOTHING TOLERANCE.																																				E10.2														
																																				EPS														

Batch-mode plotting can be done on either the line printer, or the Calcomp pen-and-ink plotter, or both, for any given plot. The three request cards of Point 9 allow for changing this graph mode selection by use of the three key words "PRINTER PLOT", "CALCOMP PLOT", and "CALCOMP PRINTER". Interpretation for these three cards is as follows:

1	2	3	4	5	6	7	8	9	10	11	12	13	14	15	16	17	18	19	20	21	22	23	24	25	26	27	28	29	30	31	32	33	34	35	36	37	38	39	40	41	42	43	44	45	46	47	48	49	50	51
REQUEST FOR LINE PRINTER PLOT.																																																	1	
REQUEST FOR CALCOMP PLOT.																																																	1	
REQUEST FOR CALCOMP AND LINE PRINTER PLOTS.																																																	1	

There are two possible cards for changing the status of the plotter print-head, employing the key words "PRINT HEAD OFF" and "PRINT HEAD ON". These are as per Point 10, and are given the following interpretations:

1	2	3	4	5	6	7	8	9	10	11	12	13	14	15	16	17	18	19	20	21	22	23	24	25	26	27	28	29	30	31	32	33	34	35	36	37	38	39	40	41	42	43	44	45	46	47	48	49	50	51
REQUEST FOR DRAWING OF PLOT CHARACTERS.																																																	1	
REQUEST FOR TYPING OF PLOT CHARACTERS.																																																	1	

With CalComp plotting, there is a choice of several different plotter pens, and the EMTF allows the user to specify these both for the background grid and also for the first four curves of a graph. This is via the "PEN CHOICE" request of Point 11, which reads five pen numbers. All five of these integers are confirmed in the data card interpretation:

1	2	3	4	5	6	7	8	9	10	11	12	13	14	15	16	17	18	19	20	21	22	23	24	25	26	27	28	29	30	31	32	33	34	35	36	37	38	39	40	41	42	43	44	45	46	47	48	49	50	51						
GRID & PEN CHOICES.											15	15	15	15	15																																									
											KGR	KP ₁	KP ₂	KP ₃	KP ₄																																									

For printer (character) plots, there is redefinition of the line limit for sparse plots via the "PLOT LINE LIMIT" request of Point 12. Interpretation confirms the new line limit "LINLIM":

1	2	3	4	5	6	7	8	9	10	11	12	13	14	15	16	17	18	19	20	21	22	23	24	25	26	27	28	29	30	31	32	33	34	35	36	37	38	39	40	41	42	43	44	45	46	47	48	49	50	51	
LINE LIMIT FOR SPARSE PRINTER PLOTS =																																									18										
																																									LINLIM										

1	2	3	4	5	6	7	8	9	10	11	12	13	14	15	16	17	18	19	20	21	22	23	24	25	26	27	28	29	30	31	32	33	34	35	36	37	38	39	40	41	42	43	44	45	46	47	48	49	50	51
Y-AXIS.					E13.4										E13.4										E13.4																									
LENY										YMIN										YMAX																														

The plot specification card of Point b-2 is interpreted as follows:

1	2	3	4	5	6	7	8	9	10	11	12	13	14	15	16	17	18	19	20	21	22	23	24	25	26	27	28	29	30	31	32	33	34	35	36	37	38	39	40	41	42	43	44	45	46	47	48	49	50	51	52	53	54	55
PLOT CARD.																																																						

17) Blank termination cards

Various classes of data are terminated by blank cards. Any blank card so read is interpreted as such, with an appropriate message telling what the blank card has signalled the end of. All of these are shown below, in the order that they would be encountered in a data case. Note that:

- The first 5 are associated with TACS data (if any).
- Number 9 will not be present if the user requests the output of all node voltages (by means of a "1"-punch in column 2). For a "STATISTICS" or "SYSTEMATIC" data case, this card would pertain to the base-case solution only, in any event.
- Number 11 exists only for a "STATISTICS" or "SYSTEMATIC" data case.
- Number 12, which stops execution of the EMTF, is actually the first card of the following (nonexistent) data case.

	1	2	3	4	5	6	7	8	9	10	11	12	13	14	15	16	17	18	19	20	21	22	23	24	25	26	27	28	29	30	31	32	33	34	35	36	37	38	39	40	41	42	43	44	45	46	47	48	49	50	51
1)	BLANK CARD TERMINATING TACS FUNCTION BLOCKS.																																																	1	
2)	BLANK CARD TERMINATING TACS SOURCE CARDS.																																																	1	
3)	BLANK CARD TERMINATING TACS SUPPL. VAR. CARDS.																																																	1	
4)	BLANK CARD TERMINATING OUTPUT VARIABLE REQUESTS.																																																	1	
5)	BLANK CARD TERMINATING TACS INIT. CONDIT. CARDS.																																																	1	
6)	BLANK CARD TERMINATING BRANCH CARDS.																																																	1	
7)	BLANK CARD TERMINATING SWITCH CARDS.																																																	1	
8)	BLANK CARD TERMINATING SOURCE CARDS.																																																	1	
9)	BLANK CARD ENDING NODE NAMES FOR VOLTAGE OUTPUT.																																																	1	
10)	BLANK CARD TERMINATING PLOT SPEC. CARDS.																																																	1	
11)	BLANK CARD TERMINATING STATISTICS OUTPUT CARDS.																																																	1	
12)	BLANK TERMINATION-OF-RUN CARD.																																																	1	

18) Supporting Routine Printout (Section 7.)

As described in Section 7. , certain supporting routines have been incorporated into the Transients Program structure. These have their own printout, which shall not be described here. In general, comment cards can be used with these routines, and input card images are printed out for the user, as with the Transients Program proper.

2.2 FORMAT OF PRINTED, COMPUTED RESULTS

In addition to just listing and interpreting the input data as per the preceding section, printed output of numerous different sorts can be generated by the Transients Program. Only the most important of these classes will be listed in this section.

2.2a Printed Transients Solution Variables.

As controlled by integer miscellaneous data parameter "IOUT" (see Section 1.0h), selected variables of the transient solution are outputted to the line printer every IOUT-th time-step point. This frequency can be altered as the solution progresses, if desired (see Section 1.1b). Characteristics of this time-step-loop output include the following points:

- Point 1: Variables are printed out in a fixed order, time-step by time-step, as the solution is advanced. Column headings at the start identify all output variables which will be printed.
- Point 2: The time-step number and also the time corresponding to each batch of values begins on the extreme left of the page, beneath the headings "STEP" and "TIME" .
- Point 3: Immediately thereafter, on the same line, all node voltages requested for output (see Section 1.8) are printed. These are identified by a heading bearing the node names in question. In number, such columns are noted by the message "FIRST XX OUTPUT VARIABLES ARE ELECTRIC-NETWORK NODE VOLTAGES (WITH RESPECT TO LOCAL GROUND);" which precedes the heading. Here "XX" is an integer. If over 9 node voltage outputs exist, printing continues on the line or lines immediately following.
- Point 4: Immediately to the right of the last node voltage will come all branch voltages or branch powers (as requested by column-80 punches on the branch cards in question), identified by the pair of terminal node names. The two node names are printed one above the other; if K is the top node, and M is the lower node, then three types of output are possible within this class:
- a) Voltage difference, $v_{km} = v_k - v_m$.
 - b) For switches, "power output" always represents power flow through the switch, from K to M : $P = P_{km}$
 - c) For all nonswitch branches, "power output" always represents the loss, input, or dissipation. This is $P = P_{km} + P_{mk}$.

In number, such columns are noted by the message

"NEXT XX OUTPUT VARIABLES ARE BRANCH VOLTAGES (VOLTAGE OF UPPER NODE MINUS VOLTAGE OF LOWER NODE);"

which appears immediately below the similar message for node voltages. As with node voltages, continuation on as many lines as necessary is automatically provided.

Point 5: Immediately to the right of the last branch voltage or power will come all branch currents or energies. The sign on flows is as just mentioned under Point 4, with again three types of output within this class:

- a) Branch current i_{km} (from K to M, measured at end K).
- b) For switches, "energy output" always represents the flow of energy through the switch, from K to M, since time zero:

$$E(t) = \int_0^t P_{km}(u) du$$

- c) For all nonswitch branches, "energy output" always represents the loss, input, or dissipation. This is

$$E(t) = \int_0^t \{ P_{km}(u) + P_{mk}(u) \} du$$

In number, such columns are noted by the message

"NEXT XX OUTPUT VARIABLES ARE BRANCH CURRENTS
(FLOWING FROM THE UPPER EMTF NODE TO THE LOWER);"

which appears immediately below the similar message for branch voltages and powers. As with preceding variables, continuation on as many lines as necessary is automatically provided.

Point 6: Immediately to the right of the last branch current or energy will come all dynamic synchronous machine (S.M.) output variables. Various types of variables are possible (angles, torques, currents, etc.), as fully explained in Section 1.62 under Class 5 data. A pair of 6-character names is used for identification, with the first (upper) one always identifying the machine of interest (e.g., "MACH 3" stands for the third S.M. component, in order of input). The second (lower) name identifies the variable type (e.g., "ANG 7" stands for the angle of the 7th mass of the shaft system). In number, such columns (of S.M. variables) are noted by the message

"NEXT XX OUTPUT VARIABLES PERTAIN TO DYNAMIC SYNCHRONOUS
MACHINES, WITH NAMES GENERATED INTERNALLY;"

which appears immediately below the similar message for branch currents. As with preceding variables, continuation on as many lines as necessary is automatically provided for.

Point 7: Immediately to the right of the last S.M. variable will come all TACS output variables. These were requested using data cards as are described in Section 8.5.6. A pair of 6-character alphanumeric names is used for identification of each variable, with the first (upper) name always being "TACS ". The second (lower) name is simply the name of the TACS variable in question. In number, such TACS variable columns are noted by the message

"FINAL XX OUTPUT VARIABLES BELONG TO 'TACS' (NOTE
INTERNALLY-ADDED UPPER NAME OF PAIR)."

which appears immediately below the similar message for dynamic S.M. variables. As with preceding variables, continuation on as many lines as necessary is automatically provided for.

Sample Illustrative Output

COLUMN HEADINGS FOR THE 32 EMTP OUTPUT VARIABLES FOLLOW. THESE ARE ORDERED ACCORDING TO THE FIVE POSSIBLE EMTP OUTPUT-VARIABLE CLASSES, AS FOLLOWS

FIRST 12 OUTPUT VARIABLES ARE ELECTRIC-NETWORK NODE VOLTAGES (WITH RESPECT TO LOCAL GROUND);
 NEXT 0 OUTPUT VARIABLES ARE BRANCH VOLTAGES (VOLTAGE OF UPPER NODE MINUS VOLTAGE OF LOWER NODE);
 NEXT 4 OUTPUT VARIABLES ARE BRANCH CURRENTS (FLOWING FROM THE UPPER EMTP NODE TO THE LOWER);
 NEXT 16 OUTPUT VARIABLES PERTAIN TO DYNAMIC SYNCHRONOUS MACHINES, WITH NAMES GENERATED INTERNALLY;
 FINAL 0 OUTPUT VARIABLES BELONG TO 'TACS' (NOTE INTERNALLY-ADDED UPPER NAME OF PAIR).
 BRANCH POWER CONSUMPTION (POWER FLOW, IF A SWITCH) IS TREATED LIKE A BRANCH VOLTAGE FOR THIS GROUPING;
 BRANCH ENERGY CONSUMPTION (ENERGY FLOW, IF A SWITCH) IS TREATED LIKE A BRANCH CURRENT FOR THIS GROUPING.

STEP	TIME	C2	B2	A2	A3	C3	B3	A1	B1	C1							
		A4	B4	C4	A3 TERRA	A1 A2	B1 B2	C1 C2	MACH 1 ID	MACH IQ							
		MACH 1 IO	MACH 1 IF	MACH 1 IKD	MACH 1 IG	MACH 1 IKQ	MACH 1 IA	MACH 1 IB	MACH 1 IC	MACH EFD							
		MACH 1 MFORCE	MACH 1 MANG	MACH 1 TO GEN	MACH 1 ANG 1	MACH 1 VEL 1											
0	0.000000	0.791459E-01-0.929561E+01	0.921647E+01	0.102547E+03-0.378518E+02-0.646953E+02	0.986412E+01-0.986412E+01	0.436783E-0.105301E+03-0.858422E+02-0.194588E+02	0.000000E+00	0.647649E+01-0.568503E+01-0.791459E+00-0.682118E+01	0.532563E+0.233159E-14	0.101434E+01	0.222045E-15-0.693889E-17	0.000000E+00	0.647649E+01-0.568503E+01-0.791459E+00-0.184961E+0.603575E+00	0.881956E+00	0.382277E-06	0.118450E+03	0.000000E+00

Etc. ⋮

2.2b Non-fatal error, warning, or otherwise-informative messages

The printed EMTP output may include various messages which remind the user of special situations which have occurred during the solution, situations which the user should generally note and think about. In general, the situations in question are peculiar to the data case at hand, and will be news to the user.

Special mention should perhaps be made of conventional switching or flashover operations, which have been excluded from the tabulation of the present section. Such operations are important enough so as to be listed separately, in Section 2.2c .

A photo-reduced listing of all such EMTP informative messages will be found on the pages which immediately follow. Each message has been coded with a number, it will be noted. Added explanation of these line-printer messages then follows, as regular typewritten text. It is the sort of general verbal explanation which Program Maintenance might provide for a user, in case of an academic (i.e., non-specific) inquiry.

1. ----- WARNING. NONZERO MISC. DATA PARAMETER *COPT* IS DIFFERENT THAN [] HZ. THIS IS UNUSUAL. A VALUE OF [] WAS READ FROM COLUMNS 17-24 OF THE DATA CARD JUST READ. EXECUTION WILL CONTINUE USING THIS VALUE, AS SUSPICIOUS AS IT SEEMS TO THE T.P.

2. ----- WARNING. NONZERO MISC. DATA PARAMETER *COPT* IS DIFFERENT THAN [] HZ. THIS IS UNUSUAL. A VALUE OF [] WAS READ FROM COLUMNS 25-32 OF THE DATA CARD JUST READ. EXECUTION WILL CONTINUE USING THIS VALUE, AS SUSPICIOUS AS IT SEEMS TO THE T.P.

3. HIGH RES. ADDED BY T.P. ACROSS TYPE-99 ELEM. [] [] [] []
HIGH RES. ADDED BY T.P. ACROSS SYMCH. MACH. [] [] [] []

4. REMEMBER ----- WHAT ARE LABELED AS THE INITIAL [] BRANCH-OUTPUT CURRENTS ARE IN REALITY KARRENSAUER LOCAL VOLTAGES AT THE TWO ENDS OF THE LAST DISTRIBUTED-PARAMETER LINE OF THE DATA CASE BEING SOLVED. THE FIRST [] MODE VOLTAGES AT THE *BUS1* END ALL COME FIRST, FOLLOWED BY ALL THE CORRESPONDING ENTRIES FOR THE *BUS2* END OF THE LINE.

5. NOTE ----- THE PRECEDING PRINTOUT SHOWS THAT GROUND WAS NOT RENUMBERED FIRST IN THE TRANSIENT-NETWORK RENUMBERING. WE WILL SWAP THE NEW NUMBERS BETWEEN GROUND AND WHATEVER NODE WAS RENUMBERED FIRST. IN ORDER TO GET A LEGITIMATE NUMBERING FOR THE REST OF THE T.P. CALCULATIONS.

6. NONLINEAR AND TIME-VARYING RESISTANCES IGNORED IN STEADY STATE SOLUTION. NONLINEAR INDUCTANCES INCLUDED WITH LINEAR PART

7. COMMENT ----- NO SINUSOIDAL SOURCES REQUESTED FOR STEADY-STATE SOLUTION. THIS SOLUTION IS BYPASSED.

8. NOTICE. ----- TWO OR MORE SINUSOIDAL VOLTAGE SOURCES ARE PRESENT ON NODE [] DURING THE STEADY-STATE SOLUTION. AS PER THE USER'S MANUAL, THESE VOLTAGES WILL ALL BE ADDED TOGETHER TO GET A TOTAL NODE VALUE.

9. NOTE. ----- NODE [] HAS BOTH VOLTAGE AND CURRENT SOURCES ON IT. THE CURRENT SOURCE HAS NO EFFECT ON THE SOLUTION, THEN, AND COULD BE OMITTED.

10. WARNING. ----- SOURCE NUMBER [] ON BUS [] WILL NOT BE PRESENT DURING THE STEADY-STATE PHASOR NETWORK SOLUTION FOR INITIAL CONDITIONS. THE SOURCE FREQUENCY OF [] DIFFERS FROM THE ASSUMED SOLUTION FREQUENCY OF [] HZ BY OVER ONE PERCENT. DID THE USER PLAN ON THIS, THE T.P. MONDERS.

11. CAUTION. ----- DURING VARIATION ELIMINATION FOR STEADY-STATE SOLUTION VOLTAGES, A NEAR-ZERO DIAGONAL ELEMENT FOR NODE [] EXISTS JUST BEFORE RECIPROGATION. USING MAGNITUDES SQUARED FOR ALL 3 QUANTITIES, WE HAVE ORIGINAL DIAGONAL VALUE = [], QUESTIONABLE VALUE = [], TOLERANCE RATIO = []. THE NODE IN QUESTION MAY BE CONNECTED TO OTHER NODES, FORMING A SUBNETWORK. BUT THE SUBNETWORK HAS NO (OR VERY WEAK) PATH TO GROUND OR OTHER KNOWN-VOLTAGE NODE IN THE STEADY-STATE. SOLUTION VOLTAGES OF THIS SUBNETWORK WILL ALL BE SET TO ZERO.

12. REQUESTED OUTPUT FOR NONEXISTENT NODE [] WILL BE IGNORED.

13. STEADY-STATE PHASOR SOLUTION IS IDENTICALLY ZERO. THERE ARE NO NONZERO VALUES TO BE OUTPUTTED, SINCE NO SINUSOIDAL SOURCES WERE PRESENT FOR TIME LESS THAN ZERO.

14. NOTE. --- THIS FUNCTION BLOCK HAS THE TACS VARIABLE . INPUTTED AN EVEN NUMBER OF TIMES, WITH THE NET RESULT BEING CANCELLATION TO ZERO. ALL INPUTS NAMED ARE THIS GOING TO BE IGNORED BY THE EMP, FOR THIS PARTICULAR TACS FUNCTION BLOCK. DID THE USER REALLY INTEND THAT THIS BE THE CASE, THE EMP WONDERS.

15. RESIDUAL FLUX OF SWITCHED-L ELEMENT TO . TO . INITIAL FLUX IN COIL TO . WAVING. ASSUMPTION THAT AC STEADY STATE HAS FUNDAMENTAL FREQUENCY ONLY IS QUESTIONABLE WITH PRECEDING FLUX OUTSIDE LINEAR REGION

16. OBSERVATION. ----- THE FIRST CONDUCTOR OF A -CONDUCTOR DISTRIBUTED-PARAMETER LINE CONNECTS BUS WITH BUS . THE PRESENT CASE HAS ZERO INITIAL CONDITIONS, AND ALSO A STUDY-TERMINATION TIME WHICH IS LESS THAN THE TRAVEL TIME FOR THIS LINE. HENCE NO STORAGE OF PAST-HISTORY POINTS IS REQUIRED FOR THIS LINE (I.E., THIS LINE DOES NOT ADD TO THE SIZE OF THE LIST-8 ARRAYS IN THE CASE-TERMINATION STATISTICS).

17. OUT OF SWITCH CLOSING TIMES FALLING BEYOND TIMES THE STANDARD DEVIATION.

18. TROUBLE AT 73912 ON TYPE-39 OR 98 ELEM NUMBER

19. REQUEST FOR VOLTAGE OUTPUT OF NONEXISTENT NODE WILL BE IGNORED.

20. WARNING. YOUR INITIAL CONDITION ON WILL BE IGNORED AND RECALCULATED BY THE TACS STEADY-STATE ROUTINE.

21. PUNCHING OF CURRENTS STOPPED BECAUSE INFORMATION IS INSUFFICIENT IN THE PRESENCE OF DISTRIBUTED PARAMETERS

..... LOCK, LOCK
DURING THIS RUN, A TOTAL OF RANDOM SWITCH CLOSINGS LESS THAN THE ZERO WERE GENERATED BY THE RANDOM NUMBER GENERATOR. BUT THE TAP, HAS NO WAY OF HANDLING SUCH CLOSURES. ALL SUCH ILLEGAL CLOSING TIMES WERE CONVERTED TO TIME ZERO (THEY SHOULD SHOW UP IN THE PRINTOUT THAT WAY) FOR SIMULATION PURPOSES. THE IMPLICATIONS OF THIS MODIFICATION SHOULD BE UNDERSTOOD BY THE USER. IF IN ANY DOUBT, THE USER IS STRONGLY ADVISED TO SEEK EXPERIENCED COUNSEL ON THIS SUBJECT.
..... LOCK, LOCK

23. THE SPECIFIED GRAPH SEPARATION OF INCHES IS CONSIDERED TOO SMALL AND IS RESET TO INCHES.

24. ***** WARNING ***** REQUESTED SMOOTHING TOLERANCE OF MAY CAUSE INACCURATE PLOT.

25.

NOTE ---- THE REQUESTED BOTTOM MARGIN OF [] AND GRAPH HEIGHT OF [] REQUIRES A TOTAL PAPER HEIGHT OF []. THIS IS GREATER THAN THE HEIGHT SPECIFIED IN "CALL PAPRZ", WHICH IS []. THE REQUESTED VALUES WILL BE IGNORED AND THE LAST SPECIFIED (OR DEFAULT IF NO HEIGHT VALUES WERE EVER GIVEN) WILL BE USED.

26.

NOTE ----- A TIME SCALE OF [] WAS READ FROM COLUMNS 5-7 OF THE PRESENTING PLOT-REQUEST CARD, TOGETHER WITH THE REQUESTED MINIMUM OF [] UNITS (READ FROM COLUMNS 8-11) AND THE REQUESTED MAXIMUM OF [] UNITS (READ FROM COLUMNS 12-15). THIS IMPLIES A PLOT OF LENGTH [], WHICH EXCEEDS THE CURRENTLY IMPOSED FLAT-RED LIMIT OF [] INCHES. THE SCALE ON THE TIME AXIS WILL BE CHANGED BY THE T.P. SO THAT THE SPECIFIED RANGE COVERS EXACTLY 12 INCHES OF PAPER. IF THE USER HAS QUESTIONS, CALL PROGRAM MAINTENANCE.

27.

ACTUALLY, THE JUST-QUOTED PAPER HEIGHT IS THE PAPER HEIGHT MINUS THE OFFSET HEIGHT OF [] FOR THE ONE OR MORE GRAPHS WHICH HAVE ALREADY BEEN DRAWN VERTICALLY BELOW THE UPCOMING PLOT. THE USER SHOULD NOT INCREASE VERTICAL DIMENSIONS UNLESS HE IS AT THE BOTTOM OF THE PAPER, OR UNLESS HE IS SURE THAT HE HAS SUFFICIENT VERTICAL SPACE LEFT ON THE PAPER FOR AT LEAST ONE MORE PLOT. THE SIZE ADJUSTMENT REMAINS CANCELLED.

28.

THE NUMBER SPECIFYING THE UNITS ON THE HORIZONTAL SCALE, PUNCHED IN COLUMN 4 OF THE PLOT REQUEST CARD, MUST BE BETWEEN 1 AND 5 (INCLUSIVE). THE NUMBER READ FROM THE LAST SUCH CARD WAS []. THIS PLOT REQUEST IS CANCELLED.

29.

BUS NAME "[]" OF THE USER'S LAST-READ PLOT CARD IS NOT THE NAME OF A BUS HAVING NODE VOLTAGE OUTPUT. HENCE THIS FIELD WILL BE IGNORED BY THE T.P. (TREATED AS IF IT HAD BEEN BLANK). THE USER IS REMINDED THAT CORRECT SPELLING AND THE CONSISTENT POSITIONING OF ALL BLANKS WITHIN THE DATA FIELDS OF WIDTH 6 FOR ALL BUS NAMES IS REQUIRED.

30.

THE USER'S LAST-READ PLOT CARD REQUESTS A PLOT FOR A BRANCH-VARIABLE WHICH IS IDENTIFIED BY TERMINAL NAMES "[]" AND "[]". BUT THE T.P. CANNOT FIND THIS REQUESTED VARIABLE IN THE LIST OF OUTPUT VARIABLES, SO THIS PARTICULAR PLOT REQUEST MUST BE IGNORED. THE USER IS REMINDED THAT CORRECT SPELLING AND THE CONSISTENT POSITIONING OF ALL BLANKS WITHIN THE DATA FIELDS OF WIDTH 6 FOR ALL BUS NAMES IS REQUIRED. ALSO, THE USER SHOULD BE REMINDED THAT BRANCH-OUTPUT REQUESTS ARE MADE USING COLUMN-80 PUNCHES ON THE BRANCH CARDS IN QUESTION. THE USER SHOULD DOUBLE-CHECK THAT HE REALLY HAS REQUESTED THE OUTPUT VARIABLE WHICH HE IS TRYING TO PLOT (AND WHICH GOT HIM IN TROUBLE). ONE COMMON ERROR IS TO REQUEST ONLY BRANCH-CURRENT OUTPUT (A 1-PUNCH IN COLUMN 80) AND THEN TRY TO PLOT BRANCH VOLTAGE [] OR VICE VERSA. FINALLY, THE USER SHOULD CHECK THAT BRANCH OUTPUT IS EVEN POSSIBLE FOR THE COMPONENT IN QUESTION, SINCE COLUMN-80 PUNCHES MAY BE IGNORED IF THE COMPONENT IN QUESTION DOES NOT PROVIDE FOR SUCH OUTPUT. ANY BRANCH-OUTPUT REQUEST FOR A MULTI-PHASE DISTRIBUTED LINE FALLS INTO THIS CLASS, IT WILL BE NOTED.

31.

PLOT CARD ERROR. TIME-AXIS SPECIFICATION IS ILLEGAL. THIS PLOT REQUEST IS BEING SKIPPED.

32.

NO VALID PLOT-VARIABLE NAME OR NAMES WAS PUNCHED ON THE USER'S LAST-READ PLOT CARD. HENCE THE T.P. WILL IGNORE THIS PLOT CARD COMPLETELY, AND GO ON TO READ THE NEXT ONE (FUN AND GAMES CONTINUED).

33.

*** THE PLOTTING ARRAY EV HAS BEEN DIMENSIONED SUCH THAT THE WORKING SIZE IS []. THIS IS LESS THAN WHICH IS THE SIZE REQUIRED FOR THIS PLOT. THIS REQUEST IS CANCELLED.

34. NO PLOT POINTS FOUND BETWEEN THE REQUESTED TIME LIMITS [] TO [] THIS PLOT REQUEST CANCELLED.

WHILE SCANNING THE DATA POINTS FOR CURVES OF THE LAST-READ PLOT CARD, A NEED FOR SMOOTHING OF CURVE NUMBER [] BEYOND TIME [] SECONDS HAS BEEN DETERMINED. AT THIS POINT, [] SUCCESSIVE, UNINTERRUPTED, ALTERNATING RELATIVE MAXIMA AND RELATIVE MINIMA HAVE BEEN OBSERVED. THIS IS TAKEN AS A SIGN OF A SPUROUS MATHEMATICAL OSCILLATION, SOMETHING WHICH SHOULD NOT EXIST PHYSICALLY (AT LEAST NOT FOR AN INTELLIGENT USER WHO HAS PICKED THE TIME-STEP SIZE "DELTA T" AND THE OUTPUT FREQUENCY "FREQ" PROPERLY). AT THIS POINT, THE JUNCTION AND ORIGIN POINT Y.P. (OTHERWISE AFFECTIONATELY REFERRED TO AS "BIG BROTHFR" BY THOSE USERS WHO ARE ACCUSTOMED TO HIS MODUS OPERANDI) HAS DECIDED TO SMOOTH THIS CURVE FOR ALL LATER TIME. THIS SMOOTHING INVOLVES SIMPLY THE AVERAGING OF SUCCESSIVE COORDINATES IN THE OUTPUT FILE OF PLOT-VARIABLE POINTS FOR THIS CURVE, BEFORE PLOTTING BEYOND THIS POINT IN TIME.

35. ***** NUMBER OF LINES PRINTED FOR THIS PLOT REQUEST NOW EXCEEDS THE TOTAL NUMBER OF DATA POINTS. ***** SINCE CALCOMP PLOT WAS ALSO SPECIFIED, ONLY PRINTER PLOT IS CANCELLED FOR THIS REQUEST.

36. ***** THE NUMBER OF LINES PRINTED FOR THIS PLOT REQUEST NOW EXCEEDS THE TOTAL NUMBER OF DATA POINTS. ***** SINCE ONLY PRINTER PLOT WAS SPECIFIED, THIS PLOT REQUEST IS CANCELLED.

37. WARNING. ***** THE VARIABLE LIMITS WHICH APPLY TO THE TACS FUNCTION BLOCK WITH (OUTPUT) NAME [] FIVE SECONDS. ***** EXCEEDED. THAT IS, THE UPPER LIMIT IS NOW LESS THAN THE LOWER LIMIT, AT TIME [] SECONDS. ALTHOUGH THE SIMULATION WILL CONTINUE, STRANGE RESULTS MIGHT BE EXPECTED (BE SKEPTICAL). THESE SHALL BE NO WARNING MESSAGE FOR ANY SUBSEQUENT CRISS-CROSSING OF THE LIMITS OF ANY TACS BLOCK.

38. NOTE. ***** THE USER HAS REQUESTED A TACS VARIABLE NAMED [] FOR OUTPUT PURPOSES. THIS HAS NUMBER [] IN ORDER OF INPUT, AS READ FROM THE TACS (OUTPUT-VARIABLE SPECIFICATION CARDS. BUT THIS IS A NON-EXISTANT TACS VARIABLE, SO THE REQUEST WILL BE DISREGARDED.

39. TEMPORARY ERROR STOP. LIST 17 SIZE (NUMBER OF DYNAMIC S.M. BUSSES) AS CONTROLLED BY THE USER DOES NOT EQUAL THE INTERNAL FIXED DIMENSION FOR THE S.M. CODE. THESE VALUES ARE [] AND [], RESPECTIVELY.

40. NOTE ***** COLUMN NUMBER [] OF THE LAST-READ DATA CARD IS NON-BLANK, THEREBY REPRESENTING A REQUEST FOR OUTPUT OF THE [] OF MASS NUMBER [] OF THIS SYNCHRONOUS MACHINE (S.No.). BUT THIS S.M. HAS A SHAFT SYSTEM WHICH IS COMPOSED OF ONLY [] MASSES. THIS OUTPUT REQUEST WILL BE IGNORED BY THE ENTP.

41. WARNING. BLOCK [] HAS ITS LIMITER OPERATING DURING THE TACS DC STEADY-STATE SOLUTION. DOUBLE-CHECK THE PROGRAM OUTPUT FOR T = 0.0 FOR ANY MISUNDERSTANDING BETWEEN THE PROGRAM AND THE USER.

45.

NOTE ---- COLUMN NUMBER [] OF THE LAST-READ DATA CARD IS PUNCHED WITH THE DECIMAL DIGIT '0'. BUT THIS IS NOT A RECOGNIZABLE REQUEST FOR AN OUTPUT VARIABLE. THE EMTF WILL IGNORE THIS REQUEST, PRETENDING THAT THE COLUMN IN QUESTION IS BLANK ON THIS DYNAMIC S.M. OUTPUT-SPECIFICATION CARD.

46.

COMPLICATION. ---- THE DYNAMIC SYNCHRONOUS MACHINE (S.M.) NOW BEING INPUTTED, TAKEN TOGETHER WITH ALL PRECEDING MACHINES, HAS OVERLOADED THE AVAILABLE WORKING STORAGE FOR S.M. OUTPUT QUANTITIES OF THE TIME-STEP-LOOP PRINTOUT. THE PROGRAM LIMIT (AS PRESENTLY DIMENSIONED) IS [] S.M. OUTPUT QUANTITIES. IF REQUESTS FOR THE PRESENT MACHINE WERE TO BE HONORED, A TOTAL OF [] CELLS (INCLUDING [] FOR THE PRESENT MACHINE) WOULD BE REQUIRED. AT THIS POINT, THE EMTF LOGIC WILL IGNORE ALL OUTPUT REQUESTS FOR THE PRESENT MACHINE, AND WILL CONTINUE WITH THE READING OF INPUT DATA CARDS.

47.

NOTE. ---- THE LAST-READ DATA CARD BELONGS TO A DYNAMIC SYNCHRONOUS MACHINE, FOR WHICH THE PARAMETERS ARE TO BE MATHEMATICALLY FITTED WITHIN MODULE 'SNPFI'. OF OVERLAY NUMBER 5. THE USER REQUESTED THIS PROCEDURE BY MEANS OF THE 'PARAMETER FITTING' CARD WHICH ACCOMPANIED THE DATA CARDS FOR THIS MACHINE. BUT THE NEWTON ITERATION OF THIS FITTING PROCESS HAS NOT SUCCESSFULLY CONVERGED TO TOLERANCE 'EPSLN' = [] WITHIN THE ITERATION LIMIT OF 'NIAMAX' = []. THE LAST ITERATION WAS NUMBER [].

ACTUALLY, THE EMTF LOGIC HAS DETERMINED THAT THE ITERATION IS DIVERGING (BLOWING UP), AND SHOULD NOW BE STOPPED IN ORDER TO AVOID NUMERICAL OVERFLOW. ONE OR MORE COMPONENTS OF THE NEWTON CORRECTION VECTOR FOR THE LAST ITERATION HAVE EXCEEDED THE DIVERGENCE TOLERANCE 'EPSOIV' = [].

WELL, HAVING FAILED TO MATHEMATICALLY FIT THE MACHINE PARAMETERS, THE EMTF LOGIC WILL NOW RECOVER, AND WILL SIMPLY IGNORE THE 'PARAMETER FITTING' CARD. INPUT DATA PARAMETERS OF THIS GENERATOR WILL BE USED AS THEY WERE READ FROM THE INPUT DATA CARDS, WITHOUT ALTERATION.

48.

NOTE ---- THIS DATA CASE EMPLOYS THE REFERENCE-BRANCH FEATURE FOR LINEAR BRANCH CARDS, IN A WAY WHICH IS TRICKY. IF NOT SO INTENDED BY THE USER, THIS IS POTENTIALLY A VERY HAZARDOUS SITUATION, CAPABLE OF RESULTING IN ERRONEOUS SIMULATIONS. FOR THIS REASON, THE FOLLOWING INFORMATIVE DIAGNOSTIC INFORMATION IS BEING PROVIDED. IN ONE OR MORE INSTANCES, THE EMTF HAS OBSERVED THAT USAGE OF THE ORDERED PAIR OF REFERENCE NAMES (READ FROM DATA FIELDS 'BUS3' AND 'BUS4', COLUMNS 15-26) IS NOT UNIQUE. HERE IT NOT FOR THE RULE THAT THE FIRST SUCH QUALIFIED COMPONENT FOUND (IN ORDER OF DATA INPUT) IS ARBITRARILY TAKEN AS THE REFERENCE COMPONENT, THERE WOULD BE AMBIGUITY. SUCH SITUATIONS ARE LISTED BELOW, WHICH SHOULD BE CAREFULLY CHECKED BY THE USER TO VERIFY THAT THE CORRECT REFERENCES ARE INDEED BEING USED BY THE EMTF.

- Q. ROW [] OF TABLE CONNECTS BUS [] WITH BUS [] . BEGINNING R, L, C VALUES USED = [] . THIS IS REJECTED BECAUSE IT WAS NOT THE FIRST FOUND. : Etc. :

- D. THE PRECEDING ELEMENTS WERE ALL REJECTED BECAUSE THEY WERE PRECEDED BY THE ENTRY OF ROW [] OF THE TABLE, WHICH CONNECTS THE SAME ORDERED PAIR OF BUSES. BEGINNING R, L, C VALUES OF THIS CHOSEN REFERENCE BRANCH = [] . IT IS THIS LATTER ENTRY WHICH IS USED AS REFERENCE BY THE BRANCH OF ROW [] WHICH CONNECTS BUS [] WITH BUS [] . (AND WHICH IS THE FIRST OF ONE OR MORE USAGES OF THE REFERENCE BRANCH IN QUESTION).

49.

THE NUMBER OF ENERGIZATIONS FOR THIS STATISTICS RUN IS 1. VARIANCE AND STANDARD DEVIATION CANNOT BE COMPUTED.

50.

 WARNING. ----- ONLY [] CELLS ARE AVAILABLE FOR WORKING STORAGE THAT IS REQUIRED BY THE CODE WHICH PRINTS
 OUT STEADY-STATE ARMATURE CURRENTS FOR DYNAMIC SYNCHRONOUS MACHINE COMPONENTS. EIGHT CELLS ARE USED
 FOR EACH SINGLE-MACHINE COMPONENT, AND TWELVE FOR EACH COAL. RESULTS WHICH WOULD BE STORED IN CELLS
 NUMBERED GREATER THAN [] WILL GENERALLY BE ERRONEOUS. HENCE BEWARE, IN READING THE INITIAL-
 CONDITION ARMATURE-CURRENT PRINTOUT WHICH MAY FOLLOW, AS WELL AS S.M. TIME-STEP OUTPUT AT T=0.

51.

 WARNING ----- NODE RENUMBERING OF THE TRANSIENTS NETWORK HAS BROKEN DOWN, PRESUMABLY DUE TO TABLE OVERFLOW
 (I.E., THE NETWORK IS TOO BIG AND/OR TOO DENSE FOR THE PRESENT EMF DIMENSIONING). THE NEXT TIME THAT THE USER
 REDIMENSION THE EATP, HE IS ADVISED TO INCREASE THE SIZE OF LIST NUMBER 5 AND/OR 8. BOTH OF THESE LISTS
 CONTRIBUTE FULLY (100 PER CENT) TO DEPENDENT LIST NUMBER 99, WHICH IS WHAT HAS ACTUALLY OVERFLOWED AT THIS POINT.
 [] NODES OUT OF TOTAL OF [] WERE RENUMBERED BEFORE BREAKDOWN IN THE RENUMBERING OVERLAY.
 HAD HE MADE IT TO [] NODES, THE OPERATION WOULD HAVE TERMINATED NORMALLY (SINCE THE REMAINING ONES
 ARE ALWAYS FORCED LAST WITHOUT REGARD TO SPARSITY CONSIDERATIONS).

ANYWAY, THE EATP WILL TRY TO CONTINUE WITH EXECUTION OF THIS DATA CASE, AS BEST IT CAN. NODES WHICH WERE
 NOT RENUMBERED BEFORE THE OVERFLOW LIMIT WAS REACHED WILL NOW SIMPLY BE RENUMBERED IN THEIR ORIGINAL RELATIVE
 ORDER, WITHOUT REGARD TO SPARSITY CONSIDERATIONS. RECALL THAT THE ORIGINAL NODE ORDER COMES FROM THE ORDER OF DATA
 INPUT (THE ORDER IN WHICH NODE NAMES ARE ENCOUNTERED, AS THE EATP DATA CARDS ARE READ).
 THE FINAL RENUMBERING MAP (ORDER(I), I=1, N(OT)) WILL THEN APPEAR AS FOLLOWS

1	2	3	4	5	6	7	8	9	10	11	12	13	14	15	16	17	18	19	20
21	22	23	24	25	26	27	28	29	30	31	32	33	34						

THE K-TH SUCH ENTRY GIVES THE ROW (AND COLUMN) POSITION OF 0-D VARIABLE K IN THE REORDERED MATRIX.

52.

 WARNING. TAGS VARIABLE [] IS ALLOWED TO OPERATE OUTSIDE ITS LIMITS DURING THE STEADY-STATE SOLUTION.

53.

 NOTICE ----- OVERVOLTAGE TABULATION FOR THIS VOLTAGE VARIABLE CAN NOT CONTINUE, DUE TO INSUFFICIENT WORKING
 SPACE. STATISTICS MISCELLANEOUS DATA PARAMETER "XMAXX" HAS BEEN EXCEEDED BY THE PEAK PER UNIT
 OVERVOLTAGE (ACTUALLY, EXCEEDED BY 3.0 TIMES OR MORE).

54.

***** WARNING WARNING *****
 POSSIBLE LOSS OF SIGNIFICANCE IN ELIMINATION STEP [] WITHIN "DELG" WHICH IS CALLED BY "SOLVSN".

55.

 ONE OR MORE NONEXISTENT NODE NAMES IN VOLTAGE DIFFERENCE [] TO [] . THIS REQUEST IGNORED.

56.

 REQUEST FOR VOLTAGE OUTPUT OF NONEXISTENT NODE [] WILL BE IGNORED.

57.

 COMMENT. ----- ONE OR MORE OF THE FOUR S.M. TIME CONSTANTS JUST INPUTTED IS LESS THAN TEN TIMES THE
 TIME-STEP SIZE "DELTA". THE VALUES INVOLVED ARE AS FOLLOWS

T00P	T00F	T00PP	T00FP	T0*DELTA
[]	[]	[]	[]	[]

58.

 WARNING. ----- FREQUENCY SEMSCR [] HZ DIFFERS BY OVER FIFTY PERCENT FROM THE OLD FREQUENCY OF [] HZ. BUT NEW FREQUENCY
 OF [] HZ REJECT IT.

59.

WARNING. ----- VALUE OF DELAY EXCEEDED MAX. DELAY VALUE OF [] FOR [] AT TIME = [] THIS MESSAGE WILL NOT BE REPEATED.

60.

WARNING. ----- THE PULSE FREQUENCY AT THE PULSE TRANSPORT DELAY [] IS TOO FAST FOR THE PRESENT DELAY OF [] SEC AT SIMULATION TIME [] SEC.

61.

WARNING. ----- VALUE OF DELAY BECAME NEGATIVE FOR [] AT TIME = [] BUT LOWER LIMIT VALUE = 0.0 THIS MESSAGE WILL NOT BE REPEATED.

Message 1 : XREF (F6.2) , XOPT (E13.4)

Because any given country will generally have only one synchronous power frequency (60 Hz for the USA and Canada), nonzero miscellaneous data parameter "XOPT" will typically always equal this power frequency. Message number 1 simply reminds the user of any other nonzero usage of floating-point miscellaneous data parameter "XOPT". The reference value "XREF" is assigned within system-dependent module "SYSDEF" of overlay 1, and hence this value may vary from translation (of the UTPF; recall that the EMTP is produced by machine translation) to translation. In particular, our European friends will generally want to set this reference value to 50. (for 50 Hz).

Message 2 : CREF (F6.2) , COPT (E13.4)

This explanation is identical to that for Message 1, only here the EMTP is concerned with miscellaneous data parameter "COPT" rather than "XOPT".

Message 3 : BUS1 (A6) , BUS2 (A6) , R (E6.1)

There are actually two distinct messages in this class, one for type-99 pseudo-nonlinear resistance elements, and the other for dynamic synchronous machine components. They are grouped together here only because both involve the internal addition of a very high impedance resistor, for purposes of connectivity.

If the user has not paralleled each type-99 pseudo-nonlinear resistance element by a lumped linear element, then the EMTP will internally connect very high impedance resistors across such elements. Such a branch should not significantly affect the solution, of course. The user is informed of such an automatic addition by means of Message 3 printout, where the 80-column card image listing and interpretation are provided almost as though the user had inputted the branch himself. The card-image listing will show the terminal node names "BUS1" and "BUS2" of the type-99 nonlinear element (printed in cols. 3-14); the resistance value "R" will appear in columns 27-32.

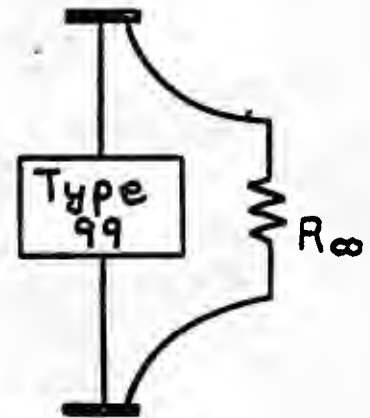

The second, related usage is for dynamic synchronous machines. See the sketch at the right, where the three armature terminal busses for phases "a", "b", and "c" have been given names "BUS A", "BUS B", and "BUS C", respectively. Now if the three armature phases are not appropriately coupled to each other electrically, through the network by means of branches which physically terminate on "BUS A", "BUS B", and "BUS C", then the EMTP will automatically add high-impedance resistive branches to provide such coupling. Such branches should not significantly affect the solution, of course. Two internally-

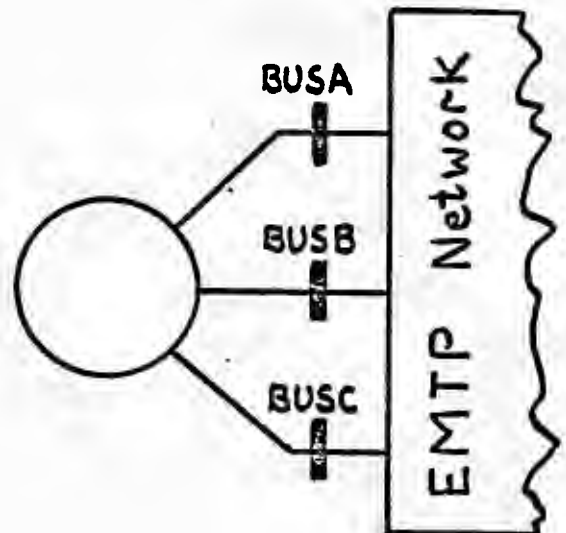

defined resistors are involved, connecting "BUSA" with "BUSB" and "BUSB" with "BUSC"; each has an ohmic value of $.01/FLZERO$, where "FLZERO" is the EMTP variable of /BLANK/ which gives a measure of the floating-point precision limit of the computer being used. "FLZERO" is assigned within system-dependent module "SYSDEP" of overlay 1, so is a function of the translation being used. For 60-bit CDC or 64-bit (8-byte) IBM translations, a value of $1.E-12$ is typical. Message 3 then provides two lines of printout for a given synchronous machine to which this inter-phase resistive coupling is being added. These simulate the 80-column card-image listing and interpretation which would have existed had the user inputted such resistive branches himself. The reader should note carefully the original phraseology about phases being "appropriately coupled". In particular, a 3-or-more-phase distributed line or Pi-circuit will satisfy the coupling requirement if connected to the machine terminals, provided the phases are ordered with conductors 1, 2, and 3 connected to machine terminal busses "BUSA", "BUSB", and "BUSC", respectively.

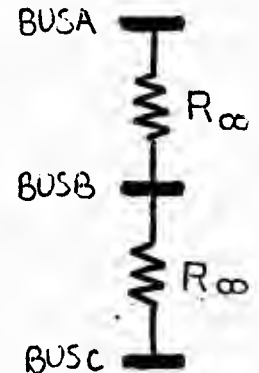

It should be mentioned that the reference branch procedure is used for these internally-defined high-resistance elements. Only the first one will show "R" as being punched in columns 27-32. All later branches will have columns 27-32 left blank, but with "BUS3" and "BUS4" of columns 15-26 referencing the first such branch. A small amount of List 3 storage space is in this way saved by the EMTP.

Message 4 : N1 (I3), MODOUT (I3)

This message is simply a reminder that the EMTP output vector may not be quite what labeling would imply, if the user has requested the special "MODE VOLTAGE OUTPUT" option which is described in Section 1.0f. Recall that Karrenbauer mode voltages at both ends of one transmission line are available for output purposes, by means of this devious option. The user inputs variable "MODOUT" (I8 information read from columns 33-40), and "N1" is always twice this value. Message 4 will always be printed for a data case which uses the "MODE VOLTAGE OUTPUT" option, immediately before the output-variable headings for the time-step loop.

Message 5 : (NORDER(I), I=1, NTOT) (2016)

Immediately preceding the three lines of diagnostic text of Message 5 will be found printout of (NORDER(I), I=1, NTOT) , which is the renumbering map from original numbers (assigned according to order of input) to transient node numbers (internal node numbering, as used for the network solution within the time-step loop). Ground is always given number one, and must be preserved this way by renumbering. Yet if the renumbering routine itself (module "OVER7") does not do this, the following EMTP code must manually make the adjustment as per the printed message. The user should not be bothered by this message, which really is just a public notice of some internal adjustments which are being made. This diagnostic seems to generally occur in practice only for very small test problems, it has been observed.

Message 6

If nonlinear, time-varying, or pseudo-nonlinear elements are present in the user's data case, he is simply reminded that the phasor (sinusoidal steady-state) solution for initial conditions requires a linear representation. Specifically, resistance elements are all assumed to be open circuits (i.e., they are "ignored"), while inductance elements are represented by linear inductances.

Message 7

The typical data case will generally involve one or more type-14 source elements which are present as part of the phasor (sinusoidal steady-state) solution for initial conditions. But if no such sources are present, there is no need to perform a phasor solution, since it is known to be identically zero. It is of this latter situation that the user is reminded by Message 7.

Message 8

As per Section 1.-b , multiple voltage sources on a single node are all interpreted as being connected in series. Message 8 is simply a reminder to the user of all such situations, for type-14 sources which are present during the phasor solution for initial conditions.

Message 9

If a current source and a voltage source are paralleled, then the current source has no effect on the network solution. This is the meaning of having two such sources connected to the same node (the A6 name of which is read from columns 3-8 of the source card). At least for the phasor (sinusoidal steady-state) solution for initial conditions, to which Message 9 applies, such extraneousness is pointed out to the user.

Message 10

The phasor (sinusoidal steady-state) solution for initial conditions is performed for only a single frequency, namely that of the first type-14 source (in order of data input) which is present in the sinusoidal steady state. That is, the first source having field "TSTART" of columns 61-70 punched with a negative value. Any other type-14 source having "TSTART" punched negative

will also be accepted at this same frequency, provided the requested frequency (columns 21-30) does not differ by over one percent from the original (first) frequency. Deviations of over one percent will exclude such a source from the phasor solution, and produce the Message 10 text. Such an exclusion is equivalent to having "TSTART" punched non-negative for that source. The user should always pay attention to such a message, for if he did not plan on such exclusions, he will be getting a solution which is probably not at all what he expected.

Message 11 : BUS1 (A6) , D1 (E12.3) , D2 (E12.3) , D3 (E12.3)

This warning message is printed out when the elimination process on the phasor (sinusoidal steady-state) network equation set $[Y]\vec{V} = \vec{I}$ has been temporarily suspended due to the occurrence of a near-zero diagonal element just before that element is to be reciprocated. Of course all computers have limited precision for their floating-point representation, so it is impossible to say whether in theory an exact zero (as opposed to just a very small) diagonal element has been encountered.

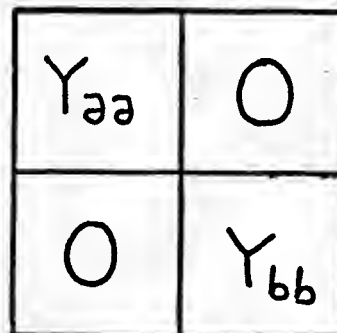

If the phasor network consists of two disconnected subnetworks as sketched at the right, the associated complex nodal admittance matrix $[Y]$ is block diagonal, as sketched above. Of course ground is the reference node for the equations, which for purposes of this explanation may be assumed to be in subsystem B without any loss of generality. Then subsystem A has no path to ground, nor to any non-ground node of subsystem B. Submatrix $[Y_{aa}]$ is then singular (uninvertible), which will show up during triangularization as the elimination on the last row of $[Y_{aa}]$ is being completed; after elimination to the left of the diagonal, a zero diagonal element will be observed ----- identically zero in theory, a "near-zero" floating-point number in practice.

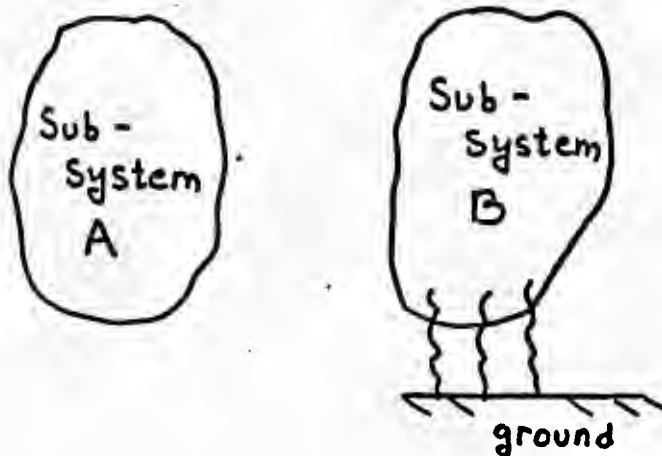

The tolerance which is used for near-zero checking of diagonal elements just before reciprocation is floating-point miscellaneous data parameter "TOLMAT" . While the user can define (input) whatever positive value he wants for this variable, it is common to use the EMTP default value. For blank or zero field "TOLMAT" on the user's floating-point miscellaneous data card, the installation dependent default value is assigned (the numerical value of which is set up in system dependent module "SYSDEP" of overlay 1. The fourth printout variable of Message 11 is $D3 = \text{TOLMAT}^{**2}$.

The "original diagonal value" which is mentioned by the message text is the value of the diagonal element of the matrix for the row which is causing trouble, before any elimination has begun. The "questionable value" which is mentioned by the message text is the value of this same diagonal element just before the reciprocation which is not being allowed. Note that "magnitudes squared" are

used for all quantities. This is because the matrix $[Y]$ is complex (has both real and imaginary parts), and yet all the user wants is a single real number which gives an indication of how small the diagonal element in question is. The magnitude or modulus of the numbers would be the natural choice, though the squares of these have been used for convenience.

If the subnetwork in question really is disconnected from the rest of the system and ground, then the stated EMTP identification and associated corrective action (setting subnetwork voltages to zero) was of course correct. In this case, the user should be happy.

On the other hand, if ties do exist from subsystem A to subsystem B (see sketch), then these ties are just too weak, and the EMTP has been fooled. In this case, either the network parameter values or "TOLMAT", or both, should be modified, since the solution with zero voltages for subsystem A nodes will generally be grossly incorrect. The resulting transient simulation may well have a substantial extraneous discontinuity or shock at time zero, because of the erroneous initial-condition voltages, note. For this reason, the user should always pay attention to Message 11, and verify that it only appears for cases where the subsequent zero-voltage solution is acceptable and correct.

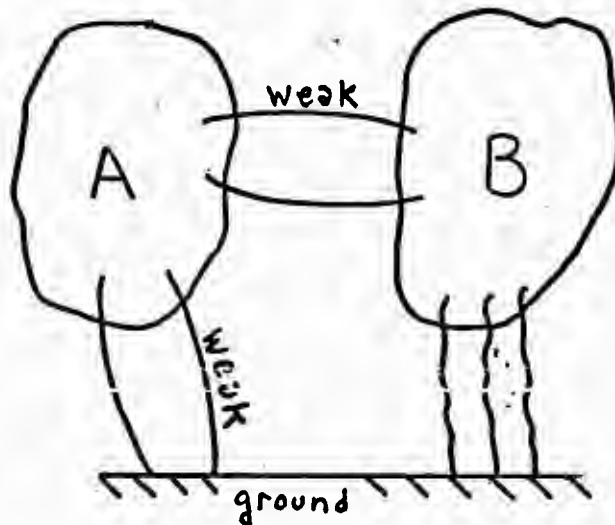

One special problem concerning Message 11 has to do with phasor solutions at frequencies which differ drastically from the synchronous power frequency. For example, dc initial conditions representing trapped charge on an unenergized line may commonly be generated by a phasor solution using frequency 0.001 Hz. But in such a case, the impedance of small "isolation" reactances become extremely small; and the impedance of capacitors becomes very large. What might well have been good strong coupling at 60 Hz can become very weak coupling at such a drastically altered frequency, then. For such usage, small isolation resistors may then be preferable to isolation reactors, since the impedance of a resistor is of course frequency invariant.

Message 12

In case program execution is to be stopped after the steady-state phasor solution is complete (which is the case if floating-point miscellaneous data parameter "TMAX" is punched non-positive), the steady-state phasor solution for transients variables is always provided. This is in addition to, and subsequent to, the possible printout of the complete steady-state solution which is controlled by integer miscellaneous data parameter "KSSOUT". Selective node voltage output requests are read as per the description of Section 1.8a. Should one or more of these A6 node names be illegal (i.e., non-existent in the user's previously-defined network), then the text of Message 12 will result. This is usually the result of a spelling error, which includes the proper positioning of blank characters in the field of width six.

Message 13

This message is clearly equivalent to Message 7, only is located in a different overlay. It's a little embarrassing, running across such duplication.

Message 14 : BUS1 (A6) , BUS2(A6)

TACS function blocks (see Section 8.5.1) all have summing junctions on the input end. As many as five A6 names of TACS variables can be specified, as inputs to the function block under consideration. Sometimes such an input name may legitimately be repeated. For example, if 2 * VOLT is wanted as an input, the user could avoid a multiplication by two if he would input "VOLT" twice (VOLT + VOLT) . Here the signs of the repeated input variable are the same --- both positive. But what if the user has opposite signs, producing exact cancellation (e.g., VOLT - VOLT) ? It is not clear how such a situation could have any useful engineering significance, but it is allowed by the EMTP. In fact, this cancellation is produced at data-input time, rather than numerically as the simulation progresses. The result is just as though the user had never punched the inputs in question.

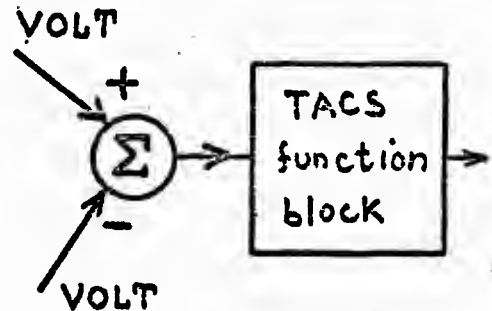
Message 15

The initial-flux message (one of 1st two lines of printout) will be outputted by the EMTP for every inductance element of the data case which is other than perfectly linear. Included, then, are:

1. Type-98 pseudo-nonlinear reactors of Section 1.29 . Recall that the saturable transformer component of Section 1.25 has a built-in type-98 element for the magnetizing branch, provided the characteristic is truly nonlinear (two or more points used to define it).
2. Type-93 true nonlinear inductance element of Section 1.33 .
3. Type-93 switch (switched-inductance) element of Section 1.52 .

The last of the 3 printed lines is only outputted if the flux in question is "out of bounds". It is important to realize what such a message means, and also what it does not mean.

First, what Message 15 does not mean. Absence of the message does not mean that sinusoidal steady-state peak phasor flux is within the bound which is being checked. It is only the flux value at time zero — which is to be used as an initial condition for the subsequent transient simulation — that is checked. This is the projection of the complex phasor $\bar{\Psi}$ on the real axis. It is possible for $|\bar{\Psi}|$ to be way out of bounds, and yet $\Psi(0)$ might be small or even zero. Absence of such a warning message thus does not imply that the true steady-state, periodic solution is sinusoidal; it may in fact be highly nonsinusoidal.

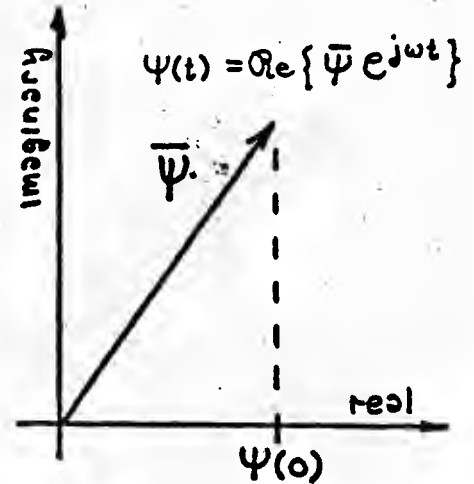

Second, there is the limit value which $\Psi(0)$ is checked against. For the true nonlinear and the pseudo-nonlinear elements, the assumed limit is Ψ_{steady} , as read from columns 33-38 of the first card defining the component in question. For switched-inductance elements, it is the breakpoint flux Ψ_s which is used, as read from columns 45-54 of the switch card.

Finally, there is the potential numerical complication which may result from initial flux being "outside the linear region".

1. For the type-93 true nonlinear inductance element, on the first time step operation will transfer to the nonlinear characteristic (see sketch). This will generally be a nearly horizontal jump (constant flux trajectory), which implies a sudden change Δi in the current. The result may well be an extraneous shock to the system, and a spurious transient. For example, if the current jump Δi is supplied through a linear inductor L in the time step of size Δt , a spurious voltage change on the order of $\Delta v = L \Delta i / \Delta t$ will appear across that element. For small time step Δt , this may be astronomical.

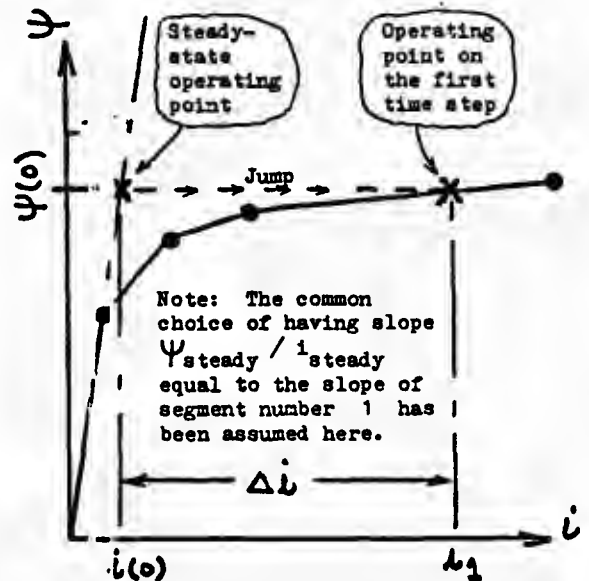

As a remedy to the just-stated difficulty, the user is free to pick i_{steady} and Ψ_{steady} so that the steady-state line passes through (or almost through)

the transient operating point. This is shown in the second sketch, below the original. If done careful, the shock at time zero can be effectively eliminated, generally.

2. For the type-98 pseudo-nonlinear inductance element, the preceding general idea of a current jump Δi at time zero is applicable. However, present type-98 element logic allows only one segment change per time step, with operation always beginning on the first segment, at time zero. Hence on the first time step operation might switch to segment number 2, on the second step to segment number 3, etc., as shown at the right. It thus may require more than one time step for operation to move to the nonlinear characteristic.

3. The switched-inductance element will simply switch from the linear slope L_1 to the saturated slope L_2 on the first time step — an operation which is well behaved numerically. Yet the user should note that operation will not be on the characteristic which he thought he was inputting! Rather, it will be on a line parallel to the input saturation segment, higher in the $\Psi-i$ plane (see sketch), which intersects the extension of the unsaturated segment at flux value $\Psi(0)$. This is because the EMTP representation consists of paralleled linear inductors, with a switch in series with one of them (see Section 1.52).

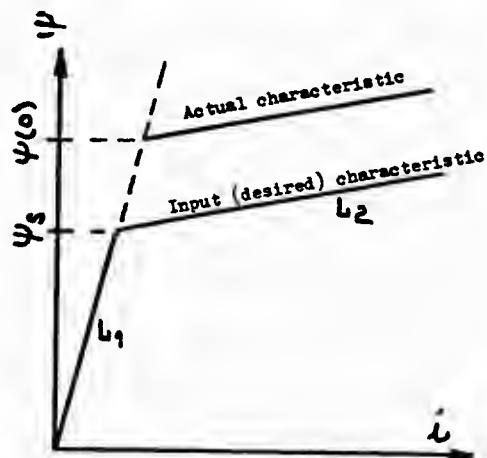
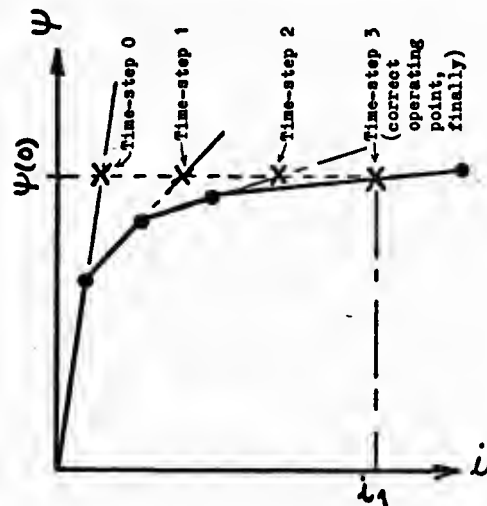
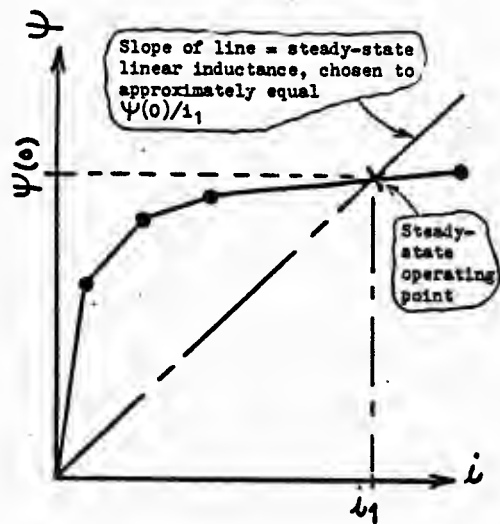

As a general remedy for the preceding complication, the user can often advantageously rotate source angles, for a balanced 3-phase system. This does not affect the problem physically, of course, since one is thereby simply redefining the time instant which one chooses to call zero. The optimal situation is to have fluxes (currents) situated at 30° , 150° , and 270° in the complex plane (phasor diagram), so that all three initial values are limited to $.866 = \sqrt{3}/2$ times the peak value. This gains 13.3% compared with the worst choice, which is frequently enough to eliminate Message 15 texts.

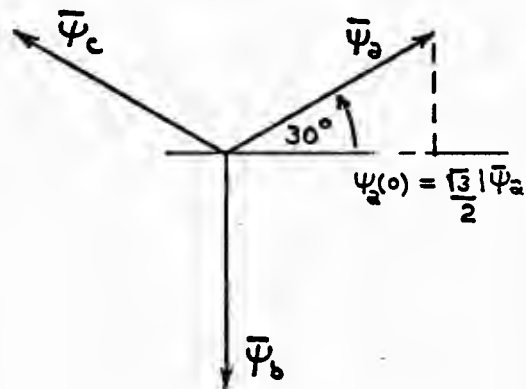

Message 16

This message text is purely informative, and is in no way a complication which should worry the user, provided data parameters for the line in question are correct. If the user is keeping track of the number of memory locations required to store the past history (List 8 of Section 0.6), he is simply reminded that no cells are required for the particular distributed line which is listed ---- because it has zero initial conditions (there was no phasor solution) and all modal travel times for the line are less than the terminal study time "TMAX" (floating-point miscellaneous data parameter). The idea here is that the EMTP is not going to store past history if the simulation will not be continued long enough for any of it ever to be used.

Message 17 : N1 (I6) , NENERG (I6) , SIGMAX (F8.4)

This message can appear only during execution of the special test procedure for the EMTP random-number generator. Recall that if integer miscellaneous data parameter "NENERG" (see Section 1.0h) is positive, and if "ISW" of the following "STATISTICS" miscellaneous data card has value 4444, then such a special test will occur. Switch closing times for the EMTP data case are generated, but no subsequent simulations are actually run. Instead, such switch closing times are simply tabulated for user scrutiny. The user specifies "SIGMAX" as the number of standard deviations on each side of the mean over which this tabulation is to be produced. If this is 3.0 or 4.0, most likely none of the sample switch closing times will fall outside the range of the tabulation, and no such Message 17 text will be seen. But should $N1 > 0$ sample switch closing times (out of the "NENERG" which were requested by the user) fall outside the tabulated range, this Message 17 text will be outputted immediately after the closing-time tabulation.

Message 18

If the user ever gets this message, simulation results must be viewed with extreme skepticism; he should review the transient characteristics of the problem being solved, to understand why the modeling being used is deficient. Modeling should then be altered, and the simulation re-run, since in most cases the present results (producing Message 18) are erroneous in some way --- perhaps totally.

Message 18 is associated with pseudo-nonlinear element trouble. Specifically, operation was on some segment other than that passing through the origin, when a sign change of the ordinate (v or ψ) has been found. See the sketch at the right, where operation on segment number 2 has been assumed for purposes of illustration. While operating on the infinite extension to segment number 2, a solution with negative ordinate value has been calculated. Clearly we are not moving slowly up and down the characteristic, then, which was one of the underlying assumptions behind successful pseudo-nonlinear element usage. Once operation

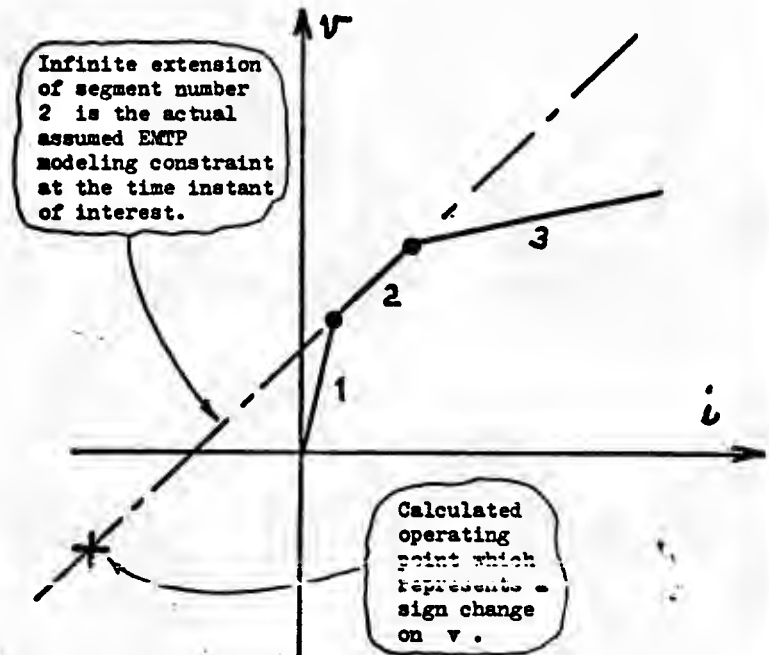

ceases to track the characteristic, the simulation becomes invalid, of course, from that point on.

It is important for the user to realize that the Message 18 text is sufficient to show erroneous pseudo-nonlinear element usage, but that its appearance is not necessary for such erroneous operation. Quite erratic, jerky, unacceptable tracking of the characteristic will go without any warning message, should such occur without a sign change of the ordinate variable (v or ψ).

Type-98 elements should always be well behaved, with the possible exception of the discontinuity at time zero. This is because the ordinate variable ψ is the integral of another network solution variable, $\psi = \int v dt$. Changes in ψ from one time step to another can be made arbitrarily small, then, by decreasing the time-step size "DELTA T" (floating-point miscellaneous data parameter). Appearance of Message 18 for a Type-98 element is usually an indication that the simulation is diverging numerically (i.e., blowing up). In this case, voltage magnitudes become arbitrarily large, and flux changes over one time step are no longer small.

It is type-99 elements which can "get into trouble", if not connected across a network element which maintains continuity of voltage either directly or indirectly. Connection across a capacitor should make them perfectly well behaved, since capacitor voltage is inherently continuous. At the other extreme, connection across an inductor can frequently cause trouble, since such voltage is capable of drastically changing from one time step to another. The EMTP memorandum dated August 26, 1974 (Reference 8) documents such difficulty.

Message 19

Identical in meaning to Message 12, only this particular output is for cases which do involve transients simulation; here the end-time of the study, floating-point miscellaneous data parameter "TMAX", is positive.

Message 20

The TACS dc steady-state initialization for $t = 0.0$ is entered if at least one TACS source of type 01, 92, or 93 is defined as active with $TSTART < 0.0$. Initial conditions are calculated for most s-blocks (see details in Section 8.4) and for all order-zero blocks. Should the user provide a user-defined initial condition for a variable that is already considered in the above calculation, this user-defined initial condition will be ignored, and the calculated dc initial condition will prevail. Note that the TACS ac steady-state initialization is a separate procedure, the results of which are superimposed to the dc initial conditions, whether the latter are TACS-calculated or user-defined.

Message 21

Integer miscellaneous data parameter "IPUN" provides for the option of punching terminal conditions of the study, if so desired. But this only works for data cases which have no distributed lines. If the user tries to exercise this punch option for a data case having distributed parameter lines, the punching will be aborted with the text of Message 21.

Message 22

When using a Gaussian distribution for random switch closing times of a statistical overvoltage study, there is always a finite probability of generating negative closing times ——— irregardless of the prescribed mean closing time \bar{T} and standard deviation σ . This is shown in the sketch of the density function at the right, where the shaded area under the left tail gives the probability of a negative, illegal switch closing time. This is for each switch, for each energization (each time we roll the dice). Since the simulation begins at time zero, the EMTP has no way of representing such negative closing times; and this is why they are called "illegal". The best the EMTP can do is close as soon as possible, namely at time zero.

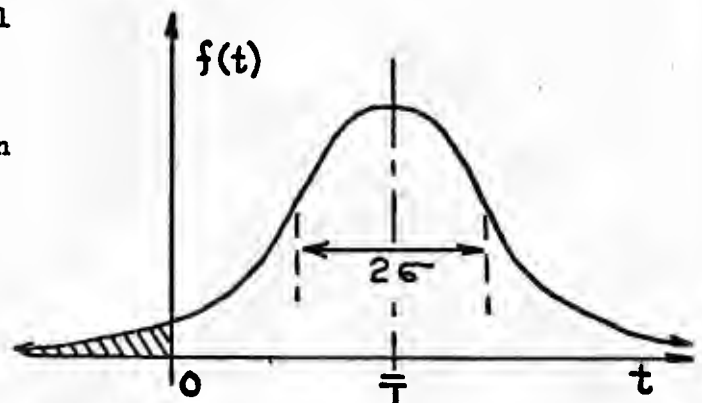

Future versions of the EMTP will have the option of cutting off the tails of a Gaussian density function $f(t)$ at some user-specified number "SIGMAX" of standard deviations from the mean. Yet if $\bar{T} - \text{SIGMAX} * \sigma$ is negative, there will still remain the possibility (probability) of negative switch closing times.

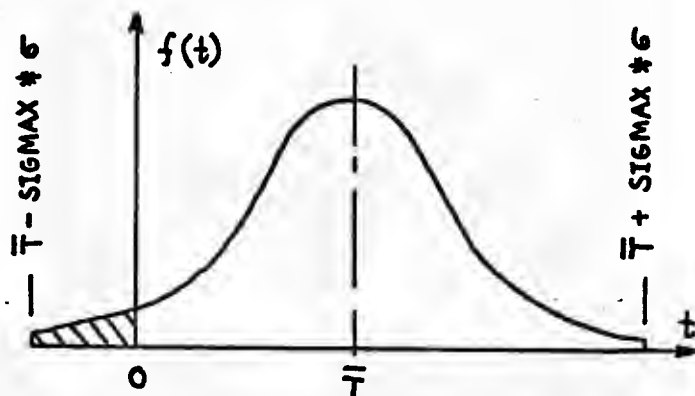

The text of Message 22 is simply informative, to remind the user that the internally-generated random numbers have been distorted so as to fit into the underlying EMTP framework. If a significant fraction of the closing times show up as having been converted to zero, the user is advised to appropriately increase the associated mean closing times T , thereby eliminating the problem. Recall that time is relative anyway, with the instant of time which is called zero an arbitrary choice of the user.

Message 23

Section 1.10-B-7 shows how the user can redefine the spacing between Calcomp plots by means of a special request card which bears the key word "MARGIN" in columns 25-30. The new inter-plot separation is the single-digit integer variable read from column 4 (field "KSEP"), which is in inches. To be legal, this must be greater than or equal to two inches. If zero or unity is punched in column 4, such a request is ignored, and the text of Message 23 is generated; the EMTP continues to use whatever separation was in effect at the time of the illegal request.

Message 24

Section 1.10-B-8 shows how the user can redefine the smoothing tolerance which is used for Calcomp plotting, by means of a special request card which bears the key word "SMOOTH" in columns 25-30. While any positive value for the new tolerance "EPS" (read from columns 16-20) is permitted, large values will lead to rather jagged looking plots. The text of Message 24 is outputted to warn the user, should he use a tolerance of 0.1 inches or more.

Message 25

Section 1.10-B-6 shows how the user can initiate a graph-size adjustment for Calcomp plots, by means of a card bearing the key word "HEIGHT" in columns 25-30. An explanation of Message 25 is given in that section.

Message 26

This message should be self-explanatory, except for clarification as to where the limit in question comes from, and why the message talks about a "flatbed" plotter when it is Calcomp plotting which is under consideration!

Conventional Calcomp drum plotters can in theory produce arbitrarily long time axes, it would seem, by simply rolling out more paper. But not everyone is actually using such hardware for the plotting. There are flatbed plotters, wherein plot dimensions are limited by table (bed) size. BPA is an example of such users, having EAI flatbed plotting hardware for which a Calcomp software interface has been provided. The limit on time-axis length, then, is to keep the pen from moving off of the table.

Anyway, for all translations the maximum plot length to be permitted is carried in variable "SZBED" of /BLANK/. While a default value is assigned in system-dependent module "SYSDEP" of overlay 1, the user can redefine this to any value that he wants, as per Section 1.0c. The default value is of course translator-dependent, with 72.0 inches typical.

Message 27 : VPLOFF (E13.4)

This message will only appear immediately after Message 25, as a qualification. Message 25 was written when the EMTP required that all plots be layed out horizontally on the plotting paper. But since then, vertical spacing (one or more plots above another) is also possible. See Rule 9 of Section 1.10-A. In the illustration at the right, "VPLOFF" is the offset height as printed in this message; it accounts for vertical space which has already been used by one or more preceding plots.

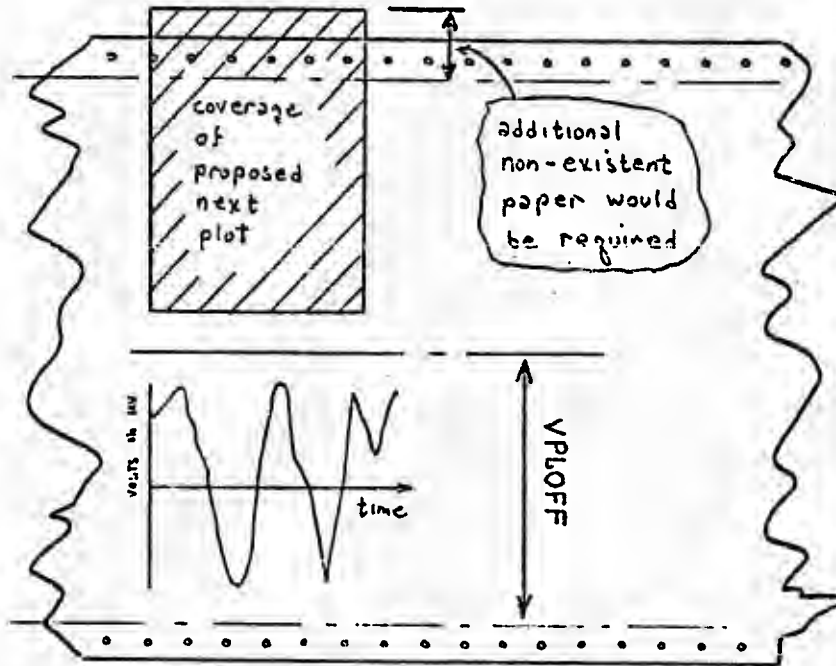
Messages 28-30

Self-explanatory.

Message 31 : HPI (E15.5), HMIN (E15.5), HMAX(E15.5)

The three variables which are printed out as part of the message are as read from columns 5-7, 8-11, and 12-15 of the plot card in question. See Point 3 of Section 1.10-B for further explanation. One of the three illegal conditions listed below has been noted:

- a) $HPI \leq 0.0$ ----- The scale of the time axis of the plot can not be negative or zero.
- b) $HMAX \leq 0.0$ ----- The ending time "HMAX" can not be negative or zero.
- c) $HMAX \leq HMIN$ ----- It is impossible for the plot to end (at end-time "HMAX") before it begins (at beginning-time "HMIN").

Message 32

Self-explanatory.

Message 33

Plotting overlay 31 is variably dimensioned automatically, whenever the user redimensions the EMTP as per Section 0.6. But because the computer code (machine instructions) for plotting is longer than that of the longest solution overlay, not all of /LABEL/ is available for dimensioned working space within plotting. It is module "VDOV31", generated by the variable-dimensioning program, which reserves the working space for plotting --- a block of memory equal to the length of /LABEL/ minus a constant offset (which approximately compensates for the extra length of the code of this

overlay). If this resulting space (never allowed to be less than unity by the variable-dimensioning program) is insufficient for plotting purposes, the plot request is simply cancelled, as per the text of Message 33.

The solution to the dilemma, of course, is to simply redimension the EMTP as per Section 0.6 . Since it is only the total length of /LABEL/ which matters, it is immaterial which of the independent lists are used to provide for the increased storage.

It should be emphasized that the number of points to be plotted on any one graph is not directly related to the appearance of Message 33. The EMTP is capable of plotting an infinite number of points on any one graph, since the working space is used only as a buffer, to be dumped onto logical unit number 9 if it should ever become full. No, Message 33 indicates a more fundamental problem: the EMTP does not even have enough working space to set up the just-mentioned buffer. This particular program version which generated Message 33 must really be dimensioned way down, designed to run in a very small memory partition.

Message 34

Self-explanatory. The EMTP simulation of course begins at time zero, and continues through time "TMAX" (floating-point miscellaneous data parameter). But the user's last-read plot-request card wanted a plot to begin and end at the times which are incorporated into the message text; these times (as read from columns 8-11 and 12-15, respectively) define an interval which does not include any times for which the solution has been found.

Message 35

This message signals the commencement of the averaging of successive plot points (for purposes of plotting only), for one of the curves of the last-read plot request card. The limiting number of oscillations (before such averaging is instituted) can be chosen at will by the user, as per Section 1.0c . For an example of an EMTP solution which would institute smoothing were the oscillation limit not disabled, see Section 1.40-C , "Remarks on opening action". This phenomena of "spurious mathematical oscillations" is further discussed in the EMTP memorandum dated November 12, 1975 (Reference 8).

Messages 36-37

The user is not allowed to stretch the time axis of a printer plot out so as to cover more lines on the paper than there are data points in the curve being plotted. If such an illegally-long printer-plot request is made, the printer plot will be truncated at the aforementioned limit, as per the text of Message 36 or Message 37.

As for the rationale behind this line limit on printer plots, it just seemed like a good way of at least bounding the amount of wasted paper, in case the user makes a gross scaling error on his time axis. "Save a tree in Oregon," as the paper-recycling sign at SCI in Palo Alto used to read. Some computers or compilers may not allow a line limit on the printed output, so hundreds or even thousands of pages of extraneous output could conceivably be generated if

one were not careful. Yet, by bounding the number of printed lines by the number of time steps of the simulation, at least a meaningful amount of computation goes along with each line of output; an astronomical number of output lines (e.g., 100000) then is not possible, because the user could never afford to run such a simulation that long to generate the raw data points! Further, such a limit should in no way interfere with production plotting usage, for it makes no sense for the user to plot fewer than one point of a curve per printer line. Maximum time-axis resolution is reached with one output plot point per printer line; it would only look worse, and confusing, if fewer than one point of the curve were outputted for each printer line.

Message 38 : BUS1 (A6)

This message will be printed for TACS function block "BUS1" if there is trouble with the limits which have been specified by the user. See Section 8.5.3 for rules about limits. In the case of two variable limits as in the sketch ("LOW" and "HIGH" are themselves TACS variables), the whole concept becomes inconsistent if the numerical value of "LOW" should ever exceed that of "HIGH". Such a contradictory situation is referred to as "criss-crossing of the limits." Rather than terminate the simulation with a fatal error stop in this case, Message 38 will appear as a warning. The user is advised to rethink his problem formulation, should he see this message. A fatal EMTP error stop really might have been more appropriate, because at the instant this message is printed, the problem as posed by the user has no solution.

Message 39 :

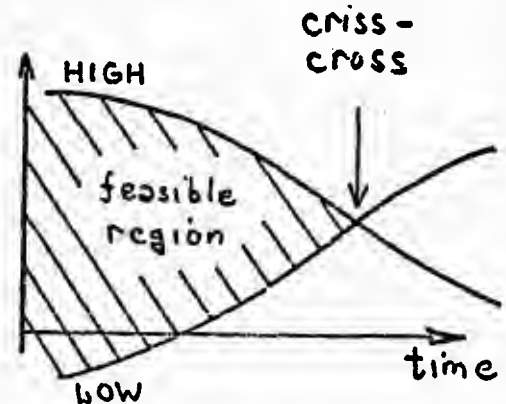
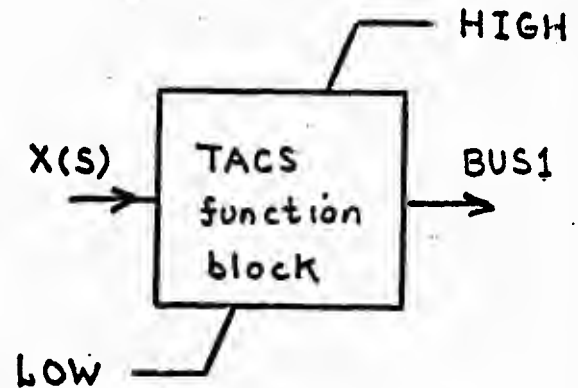

Message 40 : BUS1 (A6), N1 (I4)

This message indicates an error in preparation of the TACS output-variable specification card of Section 8.5.6 . The 6-character alphanumeric name "BUS1" is somehow in error. There is no such TACS variable, so the output request is being ignored (no such variable will be printed or plotted).

Message 42 : LSYN (I4), N5 (I4)

Rather than being just an informative message, this is also a temporary fatal error stop (FORTRAN "STOP" statement located in module "OVER5"). The message exists only because the dynamic synchronous machine (S.M.) code of Section 1.62 is not yet variably-dimensioned. See the end of Section 1.62 for a full discussion of this dimensioning problem. If the user really more than "N5" S.M. busses, and if he has selected List #17 size "LSYN" larger than this on purpose, then there is a problem; changes to the EMTF FORTRAN code will be required, in order to run the data case of interest. On the other hand, if "LSYN" was

simply chosen to be different than the printed value of "N5" by accident, then a very simple solution exists : redimension the EMTP as per Section 0.6 , using "LSYN" equal to the printed value of "N5" . As of October, 1977 (UTPF having "M20." idents), "N5" was equal to two.

Message 43 : N1 (I5), BUS1 (A6), N2(I5), N3 (I5)

This message implies an erroneous punch in column number "N1" of a Class 5 synchronous machine (S.M.) data card, as described in Section 1.62 . Variable "BUS1" will indicate which of the three types of shaft outputs is involved ---- either "ANGLE " , "SPEED " , or "TORQUE" . The third of these actually does not apply to the single mass which is listed, but to the connection between this mass and the following one. But the requested output variable simply does not exist, so can not be provided by the EMTP; the shaft system does not have this many masses (only "N3" masses exist). Presumably the user has punched the wrong column of the data card, due to carelessness.

Message 43 was written before the alternate, expanded format for Class 5 S.M. data was made available. If the expanded format is being used, eleven (11) must be subtracted from the printed value of "N1" in order to get the correct column number.

Message 44 : BUS1 (A6)

First, read Section 8.5.3 on limiters. The TACS-calculated dc steady-state calculation is a one-pass operation. Depending on the ordering of the blocks, a limit may be superimposed on a block either after or (preferably) before its value is used as input to another block. During the calculation at $t > 0.0$, the effect of the limit is at worst delayed by one time step, as discussed in 8.5.3 . But for the steady-state initialization at $t = 0.0$, there is no second chance, and should a limiter be found to operate at $t = 0.0$, the user has to make sure that all other blocks depending on the output of this limiter have indeed been calculated using the limited value.

Message 45 : N1 (I5), N4 (I1)

The same data card as has already been discussed in Message 43 is at issue here. But here the complaint is that the nonzero output-request punch "N4" is neither a one nor a two ---- the only two digits which have meaning. The second paragraph of Message 43 applies here, also.

Message 46 : JPOINT (I5), IVAR (I5), ISM (I5)

The text should be self-explanatory. The end of Section 1.62 contains complete documentation showing how the limiting program dimension might be increased, should this really be necessary. In the nomenclature of that section, "P" has value "JPOINT" as printed out in Message 46 .

Message 47 : EPSILN (E13.2), NIAMAX (I5), N1 (I5), EPSDIV (E13.2)

Paragraphs number one and number three of Message 47 are always printed; paragraph number two will only be printed in the case of numerical blow up (not in the case of insufficient number of iterations).

Further comments about the "PARAMETER FITTING" option which has experienced trouble will be found in Section 1.62, where the synchronous machine (S.M.) component is fully described; see Class 2 data cards, Point c. Message 47 might possibly be printed twice for each physical generating unit (four times for a dual machine), since d-axis parameters are fitted separately from q-axis parameters.

It should be noted that "EPSILN" is the floating-point miscellaneous data parameter of Section 1.0h, so it is under user control. The iteration limit "NIAMAX" can be redefined by means of the "TOLERANCES" card of Section 1.62 (Class 2 data cards, Point b). The blow-up tolerance "EPSDIV" is not under user control; it is hard wired into module "SMPFIT", with the value 0.5 being used as of October, 1977 (empirically set by Vladimir).

As per the final paragraph, execution will continue without parameter fitting for this axis of this machine. The subsequent simulation should be generally valid ---- at least as valid as the input data. Yet the user is advised to scrutinize his machine parameters, since the most frequent cause of divergence seems to be erroneous (either physically-unrealizable or otherwise highly improbable) data. Vladimir could tell you an interesting story about the data parameters used in Reference 18!

Message 48

The explanation of Message 48 shall be limited, due to plans which will eliminate the entire complication in the near future. Rather than use pairs of node names for reference purposes, we intend to use a branch name, when we can find the time to make the change.

Message 48 requires no explanation when it is working properly. Were it not for reference-component usage of the saturable "TRANSFORMER" component of Section 1.25, there would never be any ambiguity or confusion.

But the saturable "TRANSFORMER" component of Section 1.25 will often produce "false" warnings, which the user should learn to recognize and ignore. The problem is that, internal to the EMTP, a saturable "TRANSFORMER" is not a transformer at all; only the user thinks of it this way. At data-input time (in "OVER2"), this higher-level, conceptual interpretation is broken down into low-level EMTP building blocks:

1. One series R-L-C branch for the primary leakage (R_1 , L_1).
2. A series R-L-C branch for the magnetizing resistance R_{mag} , should the input data field be nonzero.
3. A Type-98 pseudo-nonlinear inductance element for the nonlinear magnetizing branch, if any.

4. $N-1$ separate pairs of branches, each represented by [A] and [B] matrices. Here "N" is the number of windings, and there is one such 2×2 matrix representation for each 2-winding ideal transformer (plus non-primary leakage) of the equivalent circuit.

It is this fourth item which frequently triggers the false warnings, for saturable "TRANSFORMER" components which use the reference-component option (field "BUS3" of the lead data card being nonblank). The pair of node names within Message 48 will correspond to $BUS1_2$ and $BUS2_2$ (see equivalent circuit) in the case of a 2-winding transformer. For a 3-winding unit, there may also be the second pair of node names, for the tertiary ($BUS1_3$ and $BUS2_3$).

Point to be made : The reference usage really does exist, internal to the EMTP. But the user had nothing to do with it, and should not be concerned. The user should in the case of saturable "TRANSFORMER" components disregard the warning about which elements were rejected, and which ones were used; the EMTP never makes a mistake in this case (famous last words?)!

Message 49

This message will be printed only for a "STATISTICS" or "SYSTEMATIC" data case (see Class 3A and Class 3B, Section 1.4) in which there is just one energization. This situation is user-controlled, with integer miscellaneous data parameter "NENERG" (see Section 1.0h) equal to unity. Of course no sort of meaningful tabulation is possible, for the case of just a single energization. Yet the EMTP will perform all of the conventional postprocessing of overlay #29 (module "SUBR29") ----- all except for the variance (and standard deviation) calculation. Division by $NENERG - 1 = 0$ would be required, and this is being bypassed; Message 49 is being printed instead.

Message 50

It is highly unlikely that the EMTP user will ever see this message as part of his EMTP line printer output. Only if his Program Maintenance people have redimensioned his EMTP version so as to allow just a single mass ---- only in this case might there be trouble. In terms of the COMMON /SMACH/ storage which is described at the end of Section 1.62, it is arrays $E11(M,M,2G)$ through $E22(M,M,2G)$ which are used for the armature current storage. Using the "M20." UTPF dimensions of $M = 10$ and $G = 2$, this provides a working region of 1600 cells, while only a maximum of 24 are needed. But if "M" were set to unity, note that only 16 working spaces would be available, and there would be trouble (for cases with dual machines). It should be emphasized that the time-step-loop output is unaffected by any such lack of temporary working space; the subsequent simulation will be valid; Message 50 only refers to storage which is needed for steady-state printout purposes.

Message 51 : N1 (I4), NTOT (I4), NCJRR (I6)

This message is largely self-explanatory; not much more will be added here. Message 51 will generally only be seen in conjunction with a case which has a large number of switches and/or pseudo-nonlinear elements; the terminal nodes of such elements are constrained to be renumbered last, thereby increasing the fill-in during simulated triangularization. It should be emphasized that it is the renumbering attempt for the transient network (as used in the time-step loop) which has broken down not the renumbering attempt for the steady-state network. Should the same storage inadequacy occur during renumbering for the steady-state phasor solution, a fatal EMTP error stop (with a "KILL" code, as in Section 2.4) will result.

Note that the EMTP is recovering from the storage inadequacy, as per the second paragraph of Message 51. Yet this may be only a temporary reprieve. There is a fundamental storage inadequacy, and a subsequent EMTP error stop during either the steady-state renumbering or the Y-matrix factorization or formation (for the time-step loop) is not unlikely. It is dependent List #99 (of the summary statistics which terminate each case; see Section 2.3 or 2.4) which is of inadequate size for the user's data case. EMTP redimensioning of Section 0.6 is recommended, with larger numbers for List #5 and/or List #8. Both of these lists contribute fully (100%) to List #99.

For illustrative purposes only, the renumbering map NORDER(I) has been shown as $NORDER(I) = I$, for $I=1, NTOT$. Of course this is completely problem-dependent.

Message 52 : BUS1 (A6)

This situation may occur after superimposing the dc and ac TACS-calculated steady-state initialization solutions. In this case, neither dc or ac contributions to the output of this block involved the operation of the associated limiter. But when adding the two, it is found that the output value exceeds either lower or higher limits of the block. However, the value of other blocks depending on this output has already been calculated. Read the interpretation of message 44 for more details.

Message 53

Something is grossly wrong, if the user sees Message 53. Either one or more solutions is garbage, or the user has made an error in specifying his base voltage, or both! Recall that "XMAXMX" of the "STATISTICS" or "SYSTEMATIC" miscellaneous data card (see Section 1.1a) is supposed to be a voltage level (in per unit) which should never be exceeded during any of the energizations. Then, just to be doubly sure, the EMTP multiplies this user-supplied figure by five. Message 53 then results when the user-supplied bound is exceeded by a factor of five or more! So what is wrong? Is "XMAXMX" reasonable? Are the base voltages as defined on the "STATISTICS" or "SYSTEMATIC" output cards (see Section 1.8b) reasonable? Are peak voltages for each energization reasonable? An inconsistency exists in one or more of these three areas.

Message 54 : N1 (I6)

"SOLVSM" is the principal module within the time-step loop (overlay number 16) of the SCE synchronous machine (S.M.) code which is described in Section 1.62 . For the simultaneous solution to linear equations which is required, a call to the canned equation-solution module "DGELG" is made. This is an off-the-shelf item which came from the SCE IBM/370 shop, with about 35 comment cards preserved at the beginning of the module. Read these, for a more complete explanation of the Gaussian elimination with complete pivoting which is used.

The basic complaint of Message 54 seems to be that the coefficient matrix of the linear equations is near singular, and that there is trouble in choosing the next pivot element while working on row or column number "N1" . The tolerance which is used to measure singularity in this case is actually under user control, by means of the "TOLERANCES" card (see Point b of Class 2 S.M. data, Section 1.62); variable "EPDGEL" is the tolerance for this usage. Has the user tampered with this value, compared with previous successful executions?

In the two years of IEM/CDC (64/60 bit) experience with this SCE S.M. code, Message 54 is not known to have ever been seen ---- despite production usage by a half dozen utilities. Should the user encounter Message 54 for the first time, he is definitely advised to take the line printer output to Program Maintenance for further study.

Message 55 : BUS1 (A6), BUS2 (A6)

The EMTP data case which is now being solved is a "STATISTICS" or "SYSTEMATIC" one (see integer miscellaneous data parameter "NENERG" of Section 1.0h). The base case (with all variances temporarily set to zero) has already been solved and plotted. The EMTP is now reading and processing the output requests for statistical overvoltage tabulation (see Section 1.8b). Any pair of legal node names is allowed, in making a voltage-difference request. But one or more of the user's names ("BUS1" and "BUS2" of the message) does not correspond to any node of the user's network. Is there spelling trouble? Or is there trouble with the positioning of blank characters within the alphanumeric field of width six?

Message 56 : BUS1 (A6)

The last-read data card is not a legal specification for node-voltage outputs as required by Section 1.8a . The name "BUS1" which was read from the data card does not belong to any node of the user's data case. Is there spelling trouble? Or is there trouble with the positioning of blank characters within the alphanumeric fields of width six.

Message 57 : T'_{do} , T'_{qo} , T''_{do} , T''_{qo} , $10*DELTA T$ (5E15.6)

The EMTP is currently inputting dynamic S.M. data in module "SMDATA" or "SMDAT" of overlay number 5, as described in Section 1.62 . For a Type 50, 51, or 59 machine, the third card of Class 3 S.M. data contains transient and subtransient time constants for both axes in columns 1-40 . Now, for usual power system usage, these four time constants will all be much larger than the EMTP time-step size "DELTA T" (read from the floating-point miscellaneous

data card of Section 1.0h). For example, UTPF Test Case #90 is further documented in Section 1.62 , where it is seen that the smallest of the four time constants in question is the third; and this has a value of .11782 seconds, which is typically between 100 and 1000 times the normal time-step size. But this factor of ten separation between all time constants and "DELTAT" does not hold for the user's data, as per the Message 57 printout. Was the user aware of his unusual time constants (by large-unit power system standards)? This is just a warning; the simulation will continue as requested (garbage in, garbage out).

Message 58 : BUS1 (A6)

The data case being solved involves TACS modeling, as described in Section 8. . Included is a frequency sensor having name "BUS1" ---- a Type-50 supplemental device (see Section 8.5.5). Recall that this device merely detects the time interval between successive zero-crossings of the input signal, and reciprocates twice this to give an estimate of the instantaneous frequency (whatever that is). But the new frequency which has just been calculated differs from the old one (calculated at the preceding zero-crossing; or possibly left over from the initial condition) by at least fifty percent. Such drastic changes in frequency are not allowed, for they are an indication that the solution is not varying smoothly. Possibly there was a spurious zero-crossing due to "hash" or "noise", and rejection of this latest estimate is based on this assumption. As stated in Section 8.5.5 , "the device will automatically reject higher-frequency non-characteristic oscillations appearing on the main signal." Frequency of the "main signal" is of course defined by the user as the initial frequency which is punched in columns 51-56 of the device data card.

Message 59 : BUS1 (A6), D1 (E13.6)

The data case being solved involves TACS modeling, as described in Section 8. . Included is a transport delay block bearing output name "BUS1" ---- a Type-53 supplemental device of Section 8.5.5 . Recall that the delay can be a variable (dynamically-changing) quantity, since it is the sum of a fixed delay and a named delay. Well, this total delay was never supposed to exceed the user-supplied bound of "D1" . But it did. The transport delay block needs more storage, but can not get it (dynamic expansion of the tables is not possible at this time). The simulation will continue, but is erroneous in that delays are strictly limited to time "D1" . Note that only this first instance of such saturation or clipping will be noted on the line printer. A plot would reveal the full story.

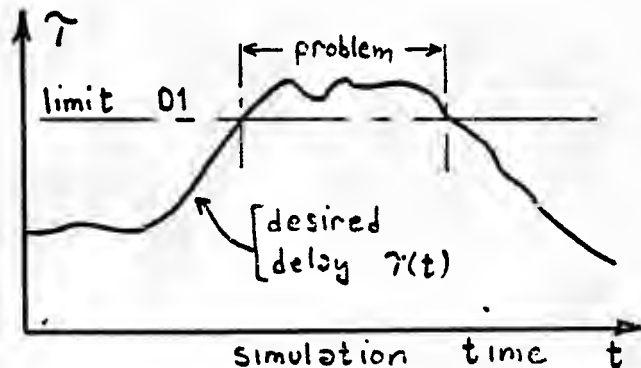

Message 60 : BUS1 (A6), D1 (E13.6), D2 (E13.6)

The data case being solved involves TACS modeling, as is described in Section 8. . Included is a pulse transport delay block bearing the output name "BUS1" ---- a Type-54 supplemental device of Section 8.5.5 . Recall that the delay must never exceed the time between successive changes in the input signal. Phrased another way, never more than one variable change can be stored within the history of the delay; it only has scalar storage (unlike the Type-53 block which has vector storage). The last change has to propagate through the delay block and out the other end before a new change is allowed in the front end. But this limitation has not been observed in the user's case.

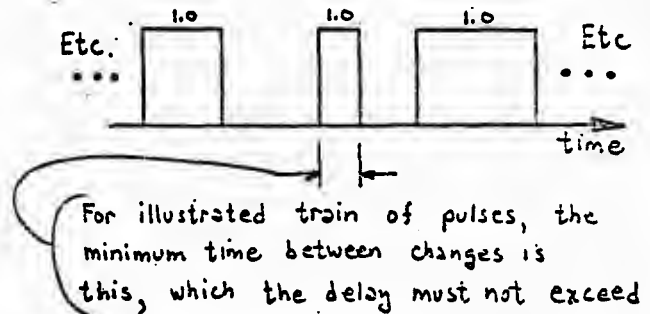

If the user sees Message 60 , possibly it is an indication of trouble elsewhere in the system. That is, problems elsewhere make for an erroneous input signal to the block, which in turn triggers this warning message. After all, garbage in, garbage out. Bob Hasibar (of BPA, Route E0GB) found this to be the case with his big ac/dc converter simulations. On the other hand, if the input signal and all other parameters of the block seem to be valid, then perhaps the user must consider switching from the Type-54 device to the Type-53 device.

Message 61 : BUS1 (A6), T (E14.6)

Similar to Message 59 . In this case, the dynamically-changing value of the delay has become negative. So as not to transform this type-53 device into a crystal ball, the lower bound on the variable delay value is 0.0 .

Message 62 BUS2 (A6), BUS2 (A6),

NOTE ---- FOR THE TYPE-96 HYSTERETIC INDUCTOR WHICH CONNECTS BUS 'A6' TO 'A6', A TRAJECTORY WAS INITIALLY CREATED WHICH WOULD HAVE CAUSED OPERATION OUTSIDE THE MAJOR HYSTERESIS LOOP. THE TRAJECTORY HAS BEEN MODIFIED TO PREVENT THIS. ACCURACY OF THE RESULTS SHOULD BE UNAFFECTED.

This message is associated with the way minor loop trajectories are created for a type-96 hysteretic inductor. A minor loop trajectory is specified in terms of the major hysteresis loop trajectory by constraining how the distance between the trajectories (along a line of constant current) varies as operation proceeds along the minor loop. This is shown below.

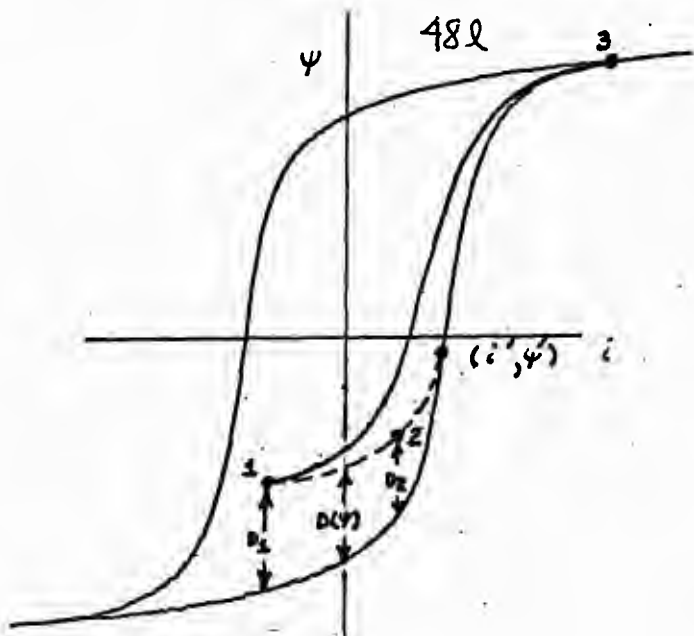

- Pt 1 (i_1, ψ_1)
- Pt 2 (i_2, ψ_2)
- Pt 3 (i_{sat}, ψ_{sat})

In this figure the solid line from pt. 1 to the saturation point indicates a minor loop trajectory, which begins at pt. 1 and extends out into the saturation region. Notice that as ψ increases from ψ_1 to ψ_{sat} , $D(\psi)$ decreases from D_1 to 0. This decrease occurs linearly and can be represented in the $D(\psi) - \psi$ plane as shown.

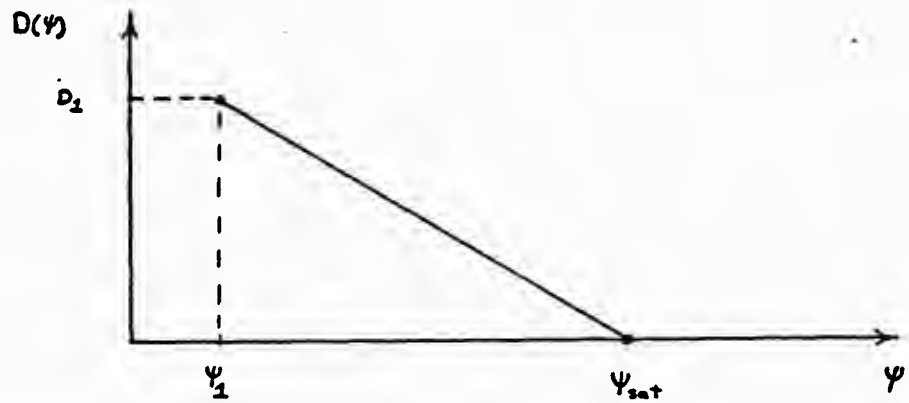

There are other instances in which it is known (from a knowledge of past behavior of the core) that the minor loop trajectory should pass through pt. 2. This requires the $D(\psi)$ function shown below.

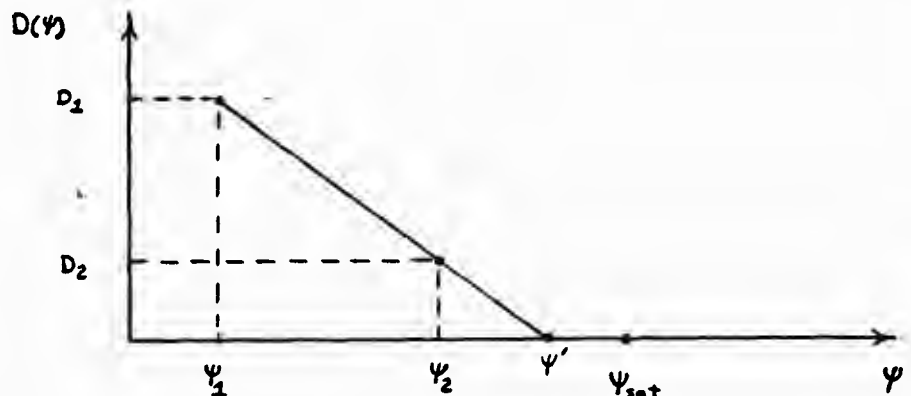

Notice that in the first instance the minor loop joined the major loop ($D(\psi)$ became zero) right at the saturation point, while in the second instance the minor loop joined the major loop at the point (i', ψ') . This is all fine. However, consider the following case.

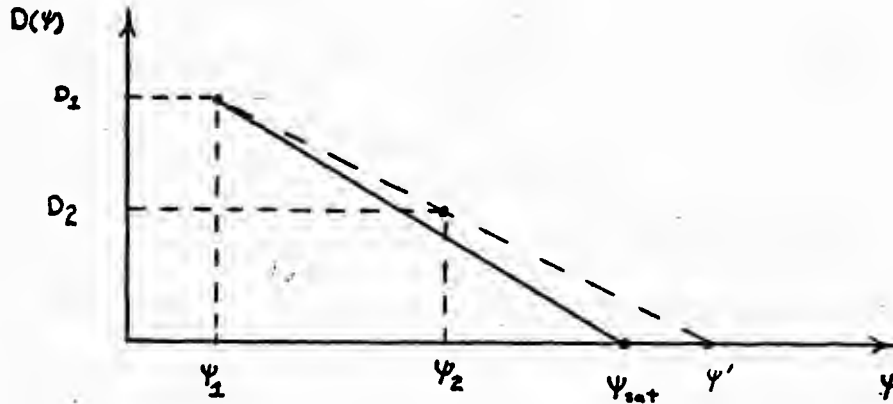

Suppose pt. 2 was located as shown in the above figure. Following the same algorithm as previously used would lead to a function $D(\psi)$ as shown by the dashed line. Notice that now $\psi' > \psi_{sat}$, which indicates that the minor and major loop trajectories would not intersect until somewhere beyond the saturation point. This is impossible, however, since beyond the saturation point there is no difference between major and minor loop trajectories (because of the single valued nature of hysteresis in the saturation region). In this case a different algorithm is chosen, which leads to the trajectory shown as a solid line. For this trajectory the major and minor loop will intersect right at the saturation point.

The occurrence of message 62 indicates that this last case described has occurred. It is anticipated that this case should occur very seldom. Should it occur the results obtained may be considered as accurate as any other results obtained using type-96

hysteresis modeling. Unless you receive this message quite often it may simply be ignored. If however, you do receive this message quite often please inform program maintenance. It may be necessary to rethink some aspects of the hysteresis algorithm.

Message 63 I, BUS(K), BUS(m), C11, CURR(I), D14, D13, D12

NOTE ---- NONLINEAR ELEMENT NUMBER I4 IS A TYPE-96 HYSTERETIC INDUCTOR WHICH IS CONNECTED BETWEEN BUSES 'A6' AND 'A6'. THE INITIAL FLUX-CURRENT POINT AS FOUND BY THE PHASOR STEADY-STATE SOLUTION HAS BEEN OBSERVED TO LIE OUTSIDE THE USER-DEFINED MAJOR HYSTERESIS LOOP, HOWEVER. THE INITIAL FLUX IS E14.4 AND THE INITIAL CURRENT IS E14.4. THE ENTP SHALL NOW ALTER THIS JUST-PRINTED FLUX SO AS TO MAKE IT LEGAL, WHILE HOLDING THE CURRENT CONSTANT. THE LINE OF CONSTANT CURRENT INTERSECTS THE USER-SUPPLIED MAJOR HYSTERESIS LOOP AT TWO POINTS (POSSIBLY EQUAL, IF THE CURRENT IS LARGE ENOUGH). THE 'UPPER' IS CUT AT FLUX VALUE E14.5, AND THE 'LOWER' AT FLUX VALUE E14.5. THE INITIAL FLUX SHALL BE TAKEN BY THE ENTP TO BE THE AVERAGE OF THESE, WHICH HAS FLUX VALUE E15.5

This message indicates a discontinuity in the solution of a problem involving a type-96 hysteretic reactor at time zero. It is a result of two different methods used to model the type-96 flux-current behavior. During a steady-state solution the type-96 is represented as a linear element, defined by the point

$i_{\text{steady}}, \psi_{\text{steady}}$ (see

section 1.3]) as shown at right. It is possible for the initial flux-current point to lie anywhere on the line, even outside of the major hysteresis loop, as shown by point a. The difficulty arises at time zero when the transient solution begins. During the transient solution the actual hysteresis behavior is modeled, and operation outside of the major loop is never allowed.

Therefore an initial point, calculated by a steady-state solution, which lies outside of the major loop violates this basic

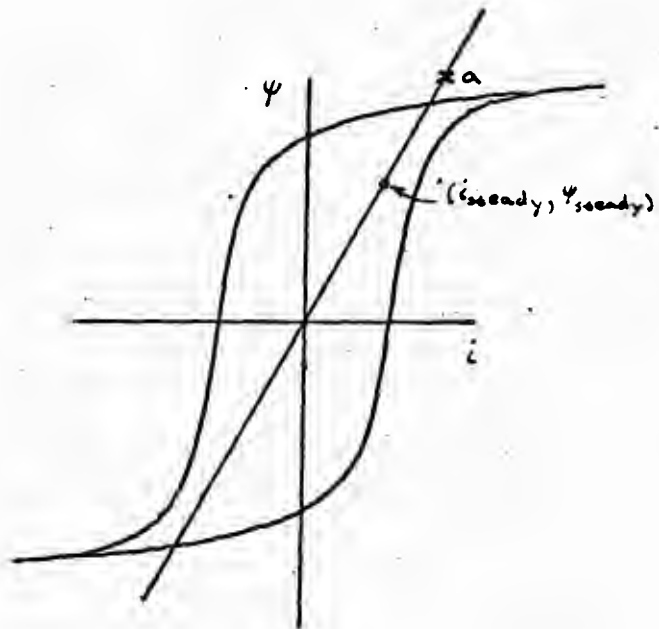

rule. In such a case it is necessary to either move the initial point inside of the loop or terminate the run at this point. It was decided to move the point within the major loop, print message 63, and leave the user with the responsibility of deciding for himself whether the changes made are acceptable or not.

The method used to move the initial point within the major loop is the following. The line of constant current is drawn through the initial point and its' intersections with the upper and lower half of the major hysteresis loop are calculated (points b and c). The average of these points (point d) is then taken as the initial point. Notice that if the value of initial current is large enough ($\geq i_{sat}$) then points b, c, and d are all the same point, namely the new initial point. This same discussion holds, of course, for an initial point in the third quadrant.

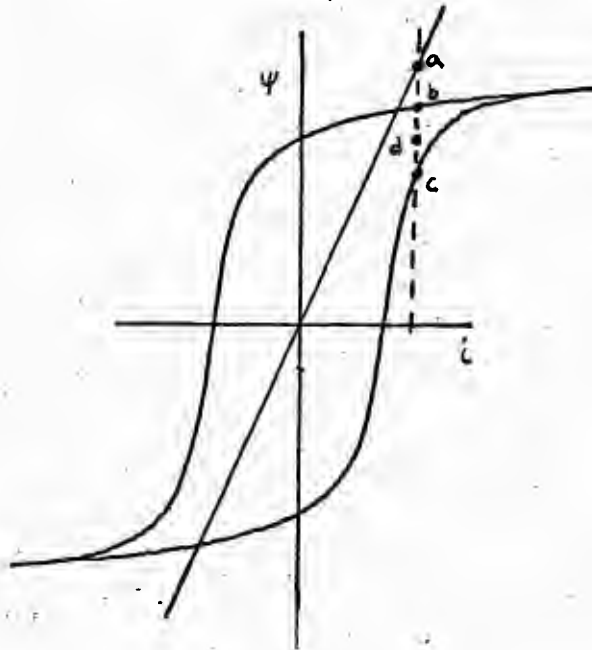

As mentioned earlier it is the users responsibility to decide if the changes made are acceptable in this case. It is very strongly suggested that the user make legitimate changes which will cause all such messages to disappear. It is important to realize that transients due to sudden changes in flux (like are being made here) may die out very slowly. A further discussion of this problem and some suggestions for correcting it are contained in Section 1.31 .

2.2c Connection Discontinuities During Solution

The closing and/or opening of switches, of switched elements, and of flashover elements is noted by means of printed messages, as the solution proceeds. Such messages thus interrupt the regular time-step printout of solution variables as described in Section 2.2a. The message texts are as follows, for the different element types which have such printout. Where sample node names are needed, the names "NODE 1" and "NODE 2" are used. Where a floating-point number is printed, the FORTRAN format specification (see Section 0.7) is used.

Ordinary Switch (Section 1.40)

The message for closure:

SWITCH 'NODE 1' TO 'NODE 2' CLOSED AFTER E12.5 SEC.

A time of -1.0 seconds is used to symbolically indicate a switch which has been closed in the steady-state.

The message for opening:

SWITCH 'NODE 1' TO 'NODE 2' OPEN AFTER E12.5 SEC.

Switched-Inductance Element (Section 1.41)

Messages for opening and closing of the saturation branch are identical to those for the ordinary switch above.

Switched-Resistance Element (Section 1.42)

Messages for opening and closing of switched-resistance branch are identical to those for the ordinary switch above. In addition, immediately above the opening message, will be found the added information concerning energy dissipation:

ENERGY ABSORBED IN SWITCHED RESISTANCE 'NODE 1' TO 'NODE 2' E15.6

The printed energy is that dissipated during the most recent interval of time that the resistance was connected (the interval between closing and opening messages).

Diode, Valve or TACS-controlled Switch (Sections 1.43, 1.44, 1.45)

Messages for the opening and closing of a type-11, type-12, or type-13 TACS-controlled switch are similar to those for the "Ordinary Switch" just described. But one difference is that here such messages must be explicitly requested by the user by the column-79 parameter "ECHO". The general form of the message is:

{

 DIODE
 VALVE
 GAP
 SWITCH

}
'NODE 1' TO 'NODE 2'
{

 OPENING
 CLOSING

}
AFTER E12.5 SEC.

Type-94 SiC Surge Arrester (Section 1.34)

Messages associated with the firing and clearing of a Type-94 modern-style SiC surge arrester component are similar to those for the switched-resistance element described above:

```
ARRESTER 'NODE 1' TO 'NODE 2' FLASHOVER AT TIME    E13.5    SEC.
ARRESTER 'NODE 1' TO 'NODE 2'  CLEARED  AT TIME    E13.5    SEC.
PER UNIT ENERGY DISSIPATED =      E14.6
```

The third line (energy dissipation) always immediately follows the second line; the first line may be separated from these by conventional time-step loop printout, of course. The per unit system as used in this message for energy dissipation is explained at the end of Section 1.34 .

Pseudo-Nonlinear Resistance (Section 1.28)

The same message text applies both to flashover and to opening, with only the segment number "XX" differing:

{	Flashover: Segment number XX = JUMP > 0
	(see columns 39-44 of input data card).
	Opening: Segment number XX = 0

The message itself reads as follows:

```
TYPE-99 N.L. ELEM 'NODE 1' TO 'NODE 2' AT T= E12.4 BEGINS OPERATION ON
SEGMENT XX.
```

Nonlinear Resistance (Section 1.32)

As per Section 1.32, the piecewise-nonlinear resistance element can only flash over; it is thereafter permanently connected. The flashover message reads as follows:

TYPE-92 NONLINEAR V-I FROM 'NODE 1' TO 'NODE 2' FIRES AT TIME E14.6 SEC.

2.2d Printout of Storage and Running-Time Statistics

At the conclusion of the solution of each data case, a half page of printout provides a summary of storage and running-time requirements. Refer to the sample output of Section 2.3 . In summary, the following will be found:

1. Current program dimensioned limits for all tables. These are identified by "list number," row by row. as per Section 0.6 .
2. Actual number of cells of these tables which the current problem has used.
3. Computer running time for this case. Central processor (CP), input-output (I/O), and total (CP + I/O) are all three printed, for each of 5 major subdivisions of the program. Sums of these are also provided, giving the total computer time attributable to execution of the case just finished. Yet caution should be used in interpreting these figures, due to variations between different computer installations. Some computers may not have a CP figure available, in which case zero contribution for this component will generally be observed. See Program Maintenance if there are questions.

2.3 Annotated Printer and Plotter Output of Sample EMTP Test Problem

The four pages which follow show photo-reduced line printer output and Calcomp plots which resulted from the EMTP solution of a sample test problem. Rather than being a meaningful production problem, this case was artificially set up for purposes of this illustrative, tutorial usage only.

It should be mentioned that the output shown came from solution on BPA's CDC-6500, with plotting done on an EAI flatbed plotter having a print head. Minor variations in the appearance of the results might be expected, were a different computer and different plotter used to solve the data case.

DATE (MM/DD/YY) AND TIME OF DAY (HH.MM.SS) = 01/22/76 14.49.54 ANY PLOTS BEAR SAME FIGURES. ELECTROMAGNETIC TRANSIENTS PROGRAM OF THE BONNEVILLE POWER ADMINISTRATION, PORTLAND, OREGON. IF IN DOUBT AS TO WHAT THE FOLLOWING PRINTOUT MEANS CONSULT THE 150-PAGE USER'S MANUAL. INDEPENDENT LIST LIMITS FOLLOW. TOTAL LENGTH OF /LABEL/ EQUALS (1730) INTEGER WORDS.

dimensions generated by variable-dimensioning program

DESCRIPTIVE INTERPRETATION OF NEW-CASE INPUT DATA INPUT DATA CARD IMAGES PRINTED BELOW, ALL 80 COLUMNS, CHARACTER BY CHARACTER.

MARKER CARD PRECEDING NEW DATA CASE. BEGIN NEW DATA CASE. COMMENT CARD. JTPF TEST CASE NO. 53. ILLUSTRATIVE SAMPLE PROBLEM WHICH IS SOLVED IN ENTP USER'S MANUAL. THE FOLLOWING TEST PROBLEM IS A JOYFURRED VERSION OF THE EXAMPLE IN REFERENCE 3 OF THE T.P. USER'S MANUAL. CONSTANT 60-HERTZ DISTRIBUTED-PARAMETER REPRESENTATION IS USED FOR THE 138-MILE LINE. THE MODIFICATIONS HAVE BEEN MADE TO ILLUSTRATE ADDED PROGRAM FEATURES, AND DO NOT SIGNIFICANTLY ALTER THE BASIC ELECTRICAL RESPONSE OF THE ORIGINAL PROBLEM.

date & time used for plotting purposes

Note total length of all labeled blocks of solution overlays

list of limits; 250 node limit on networks

Input data - branches, switches, sources.

LIST OF INPUT ELEMENTS CONNECTED TO EACH BUS. 1) ONLY THE PHYSICAL CONNECTIONS OF MULTIPHASE LINES ARE SHOWN (CAPACITIVE AND INDUCTIVE COUPLING IGNORED) 2) REPEATED ENTRIES IMPLY PARALLEL CONNECTIONS 3) SOURCES ARE OMITTED

Table with columns: FROM BUS NAME, NAMES OF ADJACENT BUSES. Includes entries for X, JOGA, JOA, JOGB, JOB, JOGC, JOC, JOC, JOC, LMA, LMB, LMC, BLUE, TERRA, LMA, LMB, BLUE.

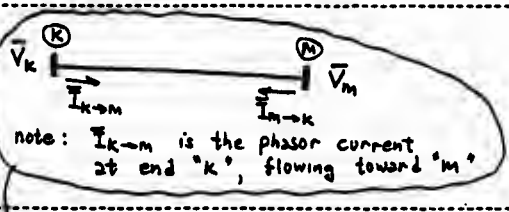

Network Connectivity Table

NONLINEAR AND TIME-VARYING RESISTANCES IGNORED IN STEADY STATE SOLUTION. NONLINEAR INDUCTANCES INCLUDED WITH LINEAR PART

Reminder message printed by program SINUSOIDAL STEADY STATE SOLUTION, BRANCH BY BRANCH. ALL FLOWS ARE AWAY FROM BUS, AND REAL PART, MAGNITUDE, OR P IS PRINTED ABOVE; IMAGINARY PART, ANGLE, OR Q.

Table with columns: BUS K, BUS M, RECTANGULAR, NODE VOLTAGE POLAR, RECTANGULAR, BRANCH CURRENT POLAR, POWER FLOW P AND Q, POWER LOSS P AND Q. Includes rows for X, TERRA, JOGA, JOA, JOGB, JOB, JOGC, JOC, JOC, LMA, LMB, LMC, BLUE, TERRA, LMA, LMB, BLUE.

local ground

50% of 2 preceding power flows

Complete Steady-state Solution printout

JOB	Node	Value	Node	Value	Node	Value	Node	Value	Node	Value
JOB		-.1536743E+06	.3073433E+06	.275411E+03	.3184207E+03	.845044E+05	.845044E+05			
		-.2661633E+06		-.1596932E+03	-30.1004	-.4693217E+08	-.4693217E+08			
	LMB	-.160000E+06	.3203184E+06	.3274181E-10	.4176807E-10	-.9579875E-06	-.9579875E-06			
JDC		-.1536651E+06	.3073433E+06	-.2760349E+03	.3184207E+03	.845044E+05	.845044E+05			
		.2661703E+06	119.5906	.1547271E+03	-150.1004	-.4693217E+08	-.4693217E+08			
	LHC	-.1995173E+06	.3203184E+06	-.9094947E-12	.2146681E-10	-.2959060E-05	-.2959060E-05			
JDC		.3030000E+06	.3030000E+06	.5070776E-01	.2894734E+02	.7642226E+04	.0			
		.0	.0000	.2894730E+02	89.8996	-.4305515E+07	.6286393E+05			
	JDA	.3073433E+06	.3073433E+06	-.5070776E-01	.2894734E+02	-.7642226E+04				
JDC		-.1515000E+06	.3030000E+06	.2504374E+02	.2894734E+02	.7682226E+04	.7450541E-08			
		.2624057E+06	-120.0000	-.1451756E+02	-30.1004	-.4305515E+07	.6286393E+05			
	JOB	-.1536703E+06	.3073433E+06	-.2504374E+02	.2894734E+02	-.7682226E+04				
JDC		-.1515000E+06	.3030000E+06	-.2509445E+02	.2894734E+02	.7682226E+04	.7450581E-08			
		.2624057E+06	-120.0000	-.1442973E+02	-150.1004	-.4305515E+07	.6286393E+05			
	JDC	-.1536651E+06	.3073433E+06	.2509445E+02	.2894734E+02	-.7682226E+04				
LMA		.3203175E+06	.3203184E+06	.0	.0	.0	.0			
		-.7404549E+03	-.1324	.0	.0	.0	.0			
	BLUE	.3203175E+06	.3203184E+06	.0	.0	.0	.0			
LMB		-.1600000E+06	.3203184E+06	-.9086074E-13	.2031708E-12	.3247662E-07	-.4235165E-21			
		-.2770329E+06	-120.1324	-.1017215E-12	.110.5651	-.2024702E-08	-.5293956E-22			
	*****	-.1600000E+06	.3203184E+06	.9086074E-13	.2031708E-12	-.3247662E-07				

Extra, internally - defined node of switched - resistance element

Complete steady - state solution branch - flow printout

SOLUTION AT NODES WITH KNOWN VOLTAGE. NODES SHOWN TOGETHER BY SWITCHES ARE SHOWN AS A GROUP OF NAMES, WITH THE PRINTED RESULT APPLYING TO THE COMPOSITE GROUP. THE ENTRY 'MVA' IS SQRT(P**2 + Q**2) IN UNITS OF POWER, WHILE 'P.F.' IS THE ASSOCIATED POWER FACTOR.

NODE NAME	SURGE NODE VOLTAGE RECTANGULAR	VOLTAGE POLAR	INJECTED SOURCE CURRENT RECTANGULAR	CURRENT POLAR	INJECTED SOURCE POWER P AND Q	SOURCE POWER MVA AND P.F.
JDC	.3030000E+06	.3030000E+06	.5377054E+08	.3184207E+03	.845044E+05	.824074E+08
JDC	-.1515000E+06	.3030000E+06	-.1596932E+03	.3184207E+03	-.4624067E+08	.824074E-02
JDC	-.1515000E+06	.3030000E+06	-.2760349E+03	.3184207E+03	.845044E+05	.824074E+08

Steady - state node - injection printout

CARD OF BUS NAMES FOR NODE-VOLTAGE OUTPUT. CARD OF BUS NAMES FOR NODE-VOLTAGE OUTPUT. BLANK CARD ENDING NUCE NAMES FOR VOLTAGE OUTPUT. FIRST 5 RESULTS ARE NODE VOLTAGES (TO LOCAL GROUND). NEXT 3 RESULTS ARE BRANCH VOLTAGES --- OR POWER CONSUMPTIONS (POWER FLOW IF SWITCH). FINAL 3 RESULTS ARE BRANCH CURRENTS --- OR ENERGY CONSUMPTIONS (ENERGY FLOW IF SWITCH).

Node voltage output cards are read & listed here

STEP	TIME	LMA	LHC	JDA	JDC	LMB	LMB TERRA	LHC	LMA	JDC	JDC
0	.000000	.3203184E+06	-.1600000E+06	-.159514E+06	.307343E+06	-.153665E+06	.0	.0	.0	.0	.0
1	.000100	.311260E+06	-.153060E+06	-.172720E+06	.307007E+06	-.163577E+06	.220502E+05	.0	.0	.0	.0
ENERGY ABSORBED IN SWITCHED RESISTANCE *LMB * TO *											
2	.000200	.310540E+06	-.142509E+06	-.142910E+06	.306454E+06	-.173272E+06	-.520760E+05	.0	.0	.0	.0
3	.000300	.309500E+06	-.131302E+06	-.192711E+06	.305373E+06	-.182719E+06	.0	.0	.0	.0	.0
4	.000400	.307979E+06	-.120224E+06	-.202280E+06	.303854E+06	-.191904E+06	.0	.0	.0	.0	.0
5	.000500	.306013E+06	-.108894E+06	-.211977E+06	.301900E+06	-.200816E+06	.0	.0	.0	.0	.0
10	.001000	.289735E+06	-.502605E+05	-.253257E+06	.203324E+06	-.239097E+06	.0	.0	.0	.0	.0
15	.001500	.262523E+06	.103410E+05	-.205802E+06	.259600E+06	-.272320E+06	.0	.0	.0	.0	.0
20	.002000	.234349E+06	.066327E+05	-.312309E+06	.224268E+06	-.294256E+06	.0	.0	.0	.0	.0
25	.002500	.196229E+06	.129652E+06	-.310409E+06	.183170E+06	-.306771E+06	.0	.0	.0	.0	.0
30	.003000	.148231E+06	.105303E+06	-.315998E+06	.131562E+06	-.306501E+06	.319906E+06	.0	.0	.0	.0
35	.003500	.858415E+05	.232633E+06	-.303276E+06	.770673E+05	-.295646E+06	.937715E+06	.0	.0	.0	.0
40	.004000	.249637E+05	.272231E+06	-.279704E+06	.201037E+05	-.279561E+06	.162318E+07	.0	.0	.0	.0
45	.004500	-.354888E+05	.300536E+06	-.248194E+06	-.397273E+05	-.244001E+06	.220689E+07	.0	.0	.0	.0
50	.005000	-.183190E+06	.312307E+06	-.214974E+06	-.947852E+05	-.205633E+06	.247207E+07	.0	.0	.0	.0
55	.005500	-.152014E+06	.315900E+06	-.171324E+06	-.147964E+06	-.159291E+06	.255803E+07	.0	.0	.0	.0
60	.006000	-.201417E+06	.312257E+06	-.117614E+06	-.194919E+06	-.109199E+06	.247150E+07	.0	.0	.0	.0
65	.006500	-.243436E+06	.297257E+06	-.080700E+05	-.236052E+06	-.151762E+05	.213527E+07	.0	.0	.0	.0
70	.007000	-.290320E+06	.273031E+06	.393841E+04	-.269227E+06	-.658517E+04	.163859E+07	.0	.0	.0	.0
75	.007500	-.300910E+06	.284316E+06	.736550E+03	-.292167E+06	.644367E+05	.115728E+07	.0	.0	.0	.0
80	.008000	-.314463E+06	.200622E+06	.131456E+06	-.306068E+06	-.119937E+06	.119937E+06	.0	.0	.0	.0
85	.008500	-.317971E+06	.141509E+06	-.144323E+06	-.305775E+06	.171366E+06	.513155E+05	.0	.0	.0	.0
ENERGY ABSORBED IN SWITCHED RESISTANCE *LMB * TO *											
90	.009000	-.304810E+06	.912064E+05	.226799E+06	-.294227E+06	.215161E+06	.0	.0	.0	.0	.0
95	.009500	-.245095E+06	.293949E+05	.263060E+06	-.276749E+06	.251804E+06	.0	.0	.0	.0	.0
100	.010000	-.261349E+06	-.396762E+05	.260774E+06	-.248306E+06	.280202E+06	.0	.0	.0	.0	.0
110	.011000	-.282410E+06	-.253737E+06	-.148235E+04	-.93111E+05	.162309E+06	.128400E+07	.741175E+03	.952571E+04	.402194E+03	.123908E+04
120	.012000	-.306158E+06	-.510851E+06	.243942E+06	-.592494E+05	.249403E+06	.924913E+07	.121971E+04	.124904E+05	.123908E+04	.123908E+04
130	.013000	-.380805E+06	-.394522E+06	.308450E+04	-.036494E+04	.180101E+06	.403223E+07	.194225E+04	.209860E+05	.105389E+04	.105389E+04
140	.014000	-.136744E+06	-.350618E+06	.305447E+04	.164670E+06	.152111E+06	.353956E+07	.152744E+04	.253701E+05	.194200E+04	.194200E+04
150	.015000	-.251247E+06	-.296403E+06	.78892E+04	.271221E+06	.131462E+05	.512198E+07	.239406E+04	.265710E+05	.148042E+04	.148042E+04
160	.016000	-.305730E+06	-.229129E+06	.367913E+04	.294310E+06	-.609080E+05	.804425E+06	.183957E+04	.295251E+05	.191665E+04	.191665E+04
170	.017000	-.402844E+06	-.447991E+05	.374966E+06	.293931E+06	-.145700E+06	.0	.189483E+04	.305264E+05	.100709E+04	.100709E+04
180	.018000	-.449342E+06	.165014E+06	.148685E+04	.257031E+06	-.239644E+06	.0	.743426E+03	.305264E+05	.110786E+04	.110786E+04
190	.019000	-.343440E+06	-.251343E+06	.124700E+04	.201979E+06	-.256812E+06	.124254E+07	.523502E+03	.311522E+05	.127911E+03	.127911E+03
200	.020000	-.272511E+06	.376362E+06	-.041195E+03	.955972E+05	-.243319E+06	.41541E+07	-.420577E+03	.341099E+05	.243339E+01	.243339E+01

Time in seconds

Node voltages

power

current

energy

current

PEAK OUTPUT VARIABLE VALUES WHICH OCCURRED DURING THE SIMULATION FOLLOW. A MINUS SIGN MEANS THAT THE PEAK ABSOLUTE VALUE OCCURRED WITH NEGATIVE POLARITY. THE ORDER AND COLUMN POSITIONING ARE THE SAME AS FOR THE REGULAR PRINTED OUTPUT VS. TIME (SEE PRINTED HEADINGS ABOVE).

.450592E+06 -.579100E+06 -.321363E+06 .310926E+06 -.314619E+06 .121255E+08 .250483E+04 .341099E+05 .199964E+14
 REQUEST FOR DRAWING OF PLOT CHARACTERS. | PRINT HEAD OFF
 PLOT SUBTITLE CARD. | 1ST SUBTITLE TEXT CARD, 78 CHARACTERS LONG, LOCAL TO THIS ONE PLOT ONLY.
 PLOT SUBTITLE CARD. | 2ND SUBTITLE TEXT CARD,
 REDEFINITION OF SMOOTHING TOLERANCE .0 | | 0.0 SMOOTH
 ** PLOT CARD. | 124 2. 8.0 20. LMS LMC REG. VOLTS, 8-PHVOLTAGE IN VOLTS
 PLOT CASE-TITLE TEXT. | 270-CHARACTER CASE-TITLE TEXT FOR USER'S MANUAL ILLUSTRATIVE TEST PROBLEM PLOT.
 REDEFINITION OF SMOOTHING TOLERANCE .1000E-01 | | .01 SMOOTH
 REQUEST FOR CALCOMP AND LINE PRINTER PLOTS. | | CALCOMP PRINTER
 REQUEST FOR TYPING OF PLOT CHARACTERS. | PRINT HEAD ON
 ** PLOT CARD. | 194 4. 0.0 22. LMB SWITCHED-R NRG NRG IN JOULES

Peak output values for plotting

Same meaning as on Calcomp plot

SWITCHED-R NRG

70-CHARACTER CASE-TITLE TEXT FOR USER'S MANUAL ILLUSTRATIVE TEST PROBLEM PLOT.

01/02/76 14.49.54 2
 PLOT TYPE 9
 NODE NAMES LMB TKRA
 MILLISECONDS

Vertical axis title from cols. 65-80 of plot card

value at extreme right of graph, printed column number 131, with tie mark

line printer plot

Units on time axis from 1" punched in col. 4 of plot card

Note overprint for first point, always

time value at 1" mark was suppressed, to avoid overprinting of curve

time value at 4" mark is $4 \times (\frac{4 \text{ msec}}{\text{inch}}) = 16 \text{ msec}$

final plotting card is blank card

BLANK CARD TERMINATING PLOT SPEC. CARDS.

CORE STORAGE FIGURES FOR PRECEDING DATA CASE NOW COMPLETED. A VALUE OF -9999 INDICATES DEFAULT, WITH NO FIGURE AVAILABLE.

SIZE LIST 1. NUMBER OF NETWORK NODES.
 SIZE LIST 2. NUMBER OF NETWORK BRANCHES.
 SIZE LIST 3. NUMBER OF DATA VALUES IN R, L, C TABLES.
 SIZE LIST 4. NUMBER OF ENTRIES IN SOURCE TABLE.
 SIZE LIST 5. MAX NUMBER OF UPPER-TRI FACTORS DURING SOLUTION.
 SIZE LIST 6. NUMBER OF ENTRIES IN SWITCH TABLE.
 SIZE LIST 7. NUMBER OF NONZERO ENTRIES IN REDUCED MATRIX (YBB/YBC).
 SIZE LIST 8. NUMBER OF PAST HISTORY POINTS FOR DISTRIBUTED LINES.
 SIZE LIST 9. NUMBER OF NONLINEAR ELEMENTS.
 SIZE LIST 10. NUMBER OF POINTS DEFINING NONLINEAR CHARACTERISTICS.
 SIZE LIST 11. NUMBER OF BRANCH OR SELECTIVE-NODE-VOLTAGE OUTPUTS.
 SIZE LIST 12. NUMBER OF OUTPUT QUANTITIES (LIMITED ONLY WHEN PRINTING MAX ABSOLUTE VALUES).
 SIZE LIST 13. NUMBER OF FREQUENCY-DEPENDENT LINES.
 SIZE LIST 14. NUMBER OF CELLS USED TO STORE FREQ.-DEPENDENCE WEIGHTING FUNCTIONS.
 SIZE LIST 15. NUMBER OF CELLS USED FOR EXPONENTIAL-TAIL LINE-HISTORY STORAGE.
 SIZE LIST 16. NUMBER OF SWITCHES BEARING CODE NAME *PART ENTER*.
 SIZE LIST 17. NUMBER OF DYNAMIC SYNCHRONOUS MACHINES.
 SIZE LIST 18. NUMBER OF BRANCH POWER-AND-ENERGY OUTPUTS.
 SIZE LIST 99. GIANT ARRAYS FOR RENUMBERING AND STEADY-STATE SOLUTION CALCULATIONS.

dependent list, a function of the size of /LABEL/ only

PRESENT FIGURE	PROGRAM LIMIT (NAME)		
13	249 (LBUS)		
12	300 (LBRNCH)		
17	500 (LDATA)		
5	100 (LXCT)		
23	1500 (LYMAT)		
3	40 (LSWTC)		
13	500 (LSMAT)		
31	1750 (LPAST)		
1	75 (LNOHL)		
5	55 (LCHAR)		
5	50 (NOUT)		
5	50 (LPEAK)		
0	5 (LFOEP)		
0	400 (LMT)		
0	50 (LTAILS)		
0	3 (LJUMP)		
0	2 (LSVN)		
1	5 (MAXPE)		
30	3112 (IOFGND)		
CP SEC	I/O SEC	SU4 SEC	
.913	1.360	2.273	
.468	1.286	1.754	
.193	.620	.773	
2.815	1.064	3.079	
6.952	12.626	19.578	
TOTALS	10.501	16.936	27.457

Case termination Statistics

TIMING FIGURES (DECIMAL) CHARACTERIZING CASE SOLUTION SPEC.
 DATA INPUT, SORTING, AND RENUMBERING (PRE STEADY STATE STUFF)
 STEADY-STATE (S.S.) SOLUTION CALCULATIONS
 POST-S.S. TO PRE-INTEGRATION-SETUP CALCULATIONS
 INTEGRATION CALCULATION (TIME IN TIME-STEP LOOP)
 COMPUTER TIME IN PLOTTING OR STATISTICS TERMINATION OVERLAY

DATE (MM/DD/YY) AND TIME OF DAY (HH.MM.SS) = 01/02/76 14.50.30 ANY PLOTS BELONG SAME FIGURES. ELECTROMAGNETIC TRANSIENTS PROGRAM OF THE BUNNELL POWER ADMINISTRATION, PORTLAND, OREGON. IF IN DOUBT AS TO WHAT THE FOLLOWING PRINTOUT MEANS, CONSULT THE 150-PAGE USER'S MANUAL. INDEPENDENT LIST LIMITS FOLLOW. TOTAL LENGTH OF /LABEL/ EQUALS 1307 INTEGER WORDS.

250 300 500 100 1500 40 500 1750 75 55 50 0 5 400 50 3

Note EMTP is shut off with blank card beginning next (nonexistent) case

DESCRIPTIVE INTERPRETATION OF NEW-CASE INPUT DATA | INPUT DATA CARD IMAGES PRINTED BELOW. A.. 80 COLUMNS, CHARACTER BY CHARACTER.

0 1 2 3 4 5 6 7 8

BLANK TERMINATION-OF-FUN CARD.

296277H

H

296277H

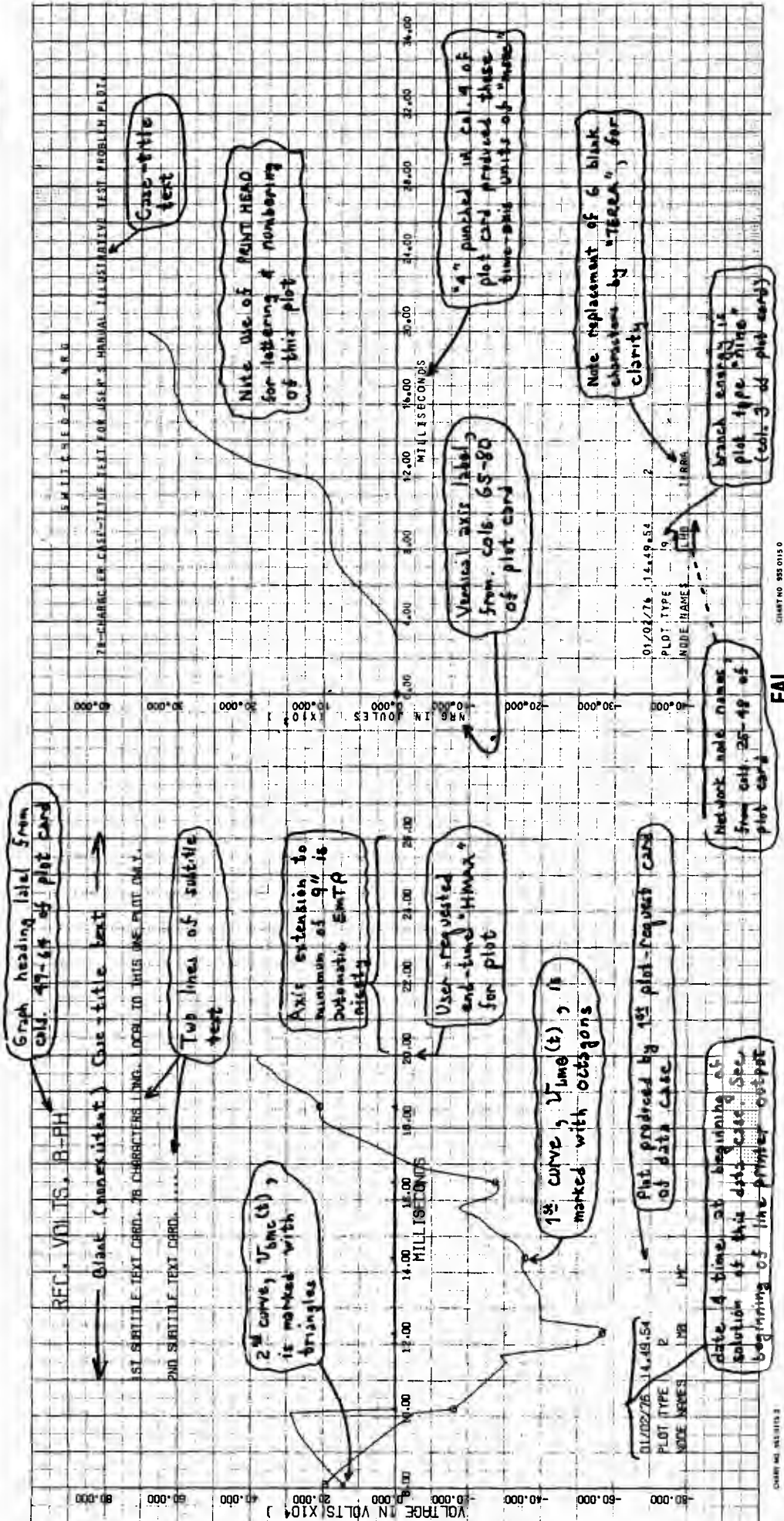

CHART NO 955 0115 0

EAI

CHART NO 955 0115 0

EAI ELECTRONIC ASSOCIATES INC WEST LONG BRANCH N J CHART NO 955 0115 0 PRINTED U.S.A.

LONG BRANCH N J CHART NO 955 0115 0 PRINTED U.S.A.

2.4 EMTP Error-Message Terminations

All sorts of user data errors or misunderstandings can produce situations where the EMTP will terminate execution of a data case being solved by means of the printing out of an appropriate error message. A sample is shown below, for which the following points might be made:

- a) "KILL CODE NUMBER" is just a characteristic number assigned to the particular error message in question; it has no special significance to the user, as such. Each different error message has such a unique number associated with it.
- b) "OVERLAY NUMBER" refers to the overlay number within the UTPF (from which the present EMTP version has been translated) where the error condition has been detected. This localizes the point of trouble to within one of the FORTRAN modules of that overlay:

Number "-1" is for the "main" code (principal module "MAIN00"), which is always in core.

Number "0" is for the first primary level overlay (principal module "MAIN10"), which calls all solution overlays (numbers 1-20).

Positive integers are associated with overlays whose principal modules have names beginning with the four letters "OVER" , and which end with the one or two digits of the overlay number. For example, overlay 13 has principal module "OVER13" .

As generated by E/T translation of the UTPF, the EMTP FORTRAN is ordered from front to back in order of increasing overlay number; this makes it easy to locate the overlay in question.

- c) "NEARBY STATEMENT NO." is the statement number of a FORTRAN statement near the point in the code where the error condition was detected. This is useful in tracing down program bugs, when reference to the FORTRAN coding is required. This statement number should always be unique. Having visually located the statement number in question (within a module of the overlay in question), control has then passed through a nearby statement which stores this number in ISTAT(19) . Shortly before or after this, the kill code number should also be assigned, to variable "KILL" .
- d) Core-storage figures which follow the error message may not all (or even "any", in extreme cases) be valid. A value of "-9999" will be found wherever the figure in question is not known by the EMTP at this point of the execution where the decision to kill the case has been made.
- e) The user will note the "case-recovery" attempt by the EMTP, after the error message and case summary statistics have all been completed. Upon the encounter of a "BEGIN NEW DATA CASE" record, solution would then begin for the following data case (if any). See Section 1.0a .

4. FORMULAS

The theory behind the TRANSIENTS program is explained in references 1-2 of Sect. 0.4. Some points will be explained in more detail here.

4.1 TRANSFORMATION USED FOR MULTIPHASE LINES

Multiphase lines with distributed parameters are assumed to be "balanced". This shall be defined as follows: The self-impedances (capacitances) of all phases are equal among themselves and all mutual impedances (capacitances) are equal among themselves. Thus, the series inductance matrix of a balanced line in the phase domain is

$$[L_{\text{phase}}] = \begin{bmatrix} L_s & L_m & L_m & \dots & L_m \\ L_m & L_s & L_m & \dots & L_m \\ L_m & L_m & L_s & \dots & L_m \\ \dots & \dots & \dots & \dots & \dots \\ L_m & L_m & L_m & \dots & L_s \end{bmatrix} \quad \text{with } \begin{cases} L_s = \text{self inductance} \\ L_m = \text{mutual inductance} \end{cases}$$

and analogous for $[C_{\text{phase}}]$.

The voltage drop along the series inductance is

$$-\left[\frac{\partial e_{\text{phase}}}{\partial t} \right] = [L_{\text{phase}}] [i_{\text{phase}}] \tag{1}$$

In eq. (1), all phases are coupled. In the TRANSIENTS program, phase quantities are transformed to mode quantities such that

$$-\left[\frac{\partial e_{\text{mode}}}{\partial t} \right] = [L_{\text{mode}}] [i_{\text{mode}}] \tag{2}$$

has a diagonal matrix $[L_{\text{mode}}]$. This means that the mode quantities become decoupled.

The transformation being used is due to H. Karrenbauer (see no. 15 in the list of references given in Ref. 1 . It has certain advantages, among them:

- (a) the transformation matrices are real,
- (b) they are identical for voltages and currents,
- (c) they are very convenient from a programming standpoint (they are valid for any number of phases so that only one general formula is necessary for any number of phases).

The transformation works only for "balanced" lines, where incidentally, it is still valid even if the line parameters are frequency-dependent.

It is defined by

$$\begin{bmatrix} e_{\text{phase}} \end{bmatrix} = \begin{bmatrix} T \end{bmatrix} \cdot \begin{bmatrix} e_{\text{mode}} \end{bmatrix} \quad (3a)$$

$$\begin{bmatrix} i_{\text{phase}} \end{bmatrix} = \begin{bmatrix} T \end{bmatrix} \cdot \begin{bmatrix} i_{\text{mode}} \end{bmatrix}$$

with $\begin{bmatrix} T \end{bmatrix} = \begin{bmatrix} 1 & 1 & 1 & \dots & 1 \\ 1 & 1-M & 1 & \dots & 1 \\ 1 & 1 & 1-M & \dots & 1 \\ \dots & \dots & \dots & \dots & \dots \\ 1 & 1 & 1 & \dots & 1-M \end{bmatrix}$, with M = number of phases (3b)

The inverse transformation,

$$\begin{bmatrix} e_{\text{mode}} \end{bmatrix} = \begin{bmatrix} T \end{bmatrix}^{-1} \cdot \begin{bmatrix} e_{\text{phase}} \end{bmatrix} , \text{ identical for current,} \quad (4a)$$

has the matrix

$$\begin{bmatrix} T \end{bmatrix}^{-1} = \frac{1}{M} \begin{bmatrix} 1 & 1 & 1 & \dots & 1 \\ 1 & -1 & & & \\ 1 & & -1 & & \\ \dots & \dots & \dots & \dots & \dots \\ 1 & & & & -1 \end{bmatrix} \quad \left. \begin{array}{l} \text{all elements are "1"} \\ \text{in first row} \end{array} \right\} \quad (4b)$$

all elements are "1" in first column
"-1" in diagonal and zeros outside diagonal

Physical meaning of mode quantities: From (4b) it can be seen that the first mode describes the loop with all conductors in parallel and return through the ground (identical to zero sequence) and the second, ..., M-th mode describes the loop consisting of the 1st conductor and return via the second, ..., M-th conductor, respectively.

Matrices in mode quantities. The series impedance matrix in mode quantities is

$$[Z_{mode}] = [T]^{-1} [Z_{phase}] [T] = \begin{bmatrix} Z_0 & & & \\ & Z_1 & & \\ & & Z_1 & \\ & & & \dots \\ & & & & Z_1 \end{bmatrix} \quad (5a)$$

$$\left. \begin{aligned} \text{with } Z_0 &= Z_s + (M-1)Z_m \\ Z_1 &= Z_s - Z_m \end{aligned} \right\} \quad (5b)$$

$$\left. \begin{aligned} \text{and vice versa } Z_s &= \frac{1}{M} [Z_0 + (M-1)Z_1] \\ Z_m &= \frac{1}{M} (Z_0 - Z_1), \end{aligned} \right\} \quad (5c)$$

where Z_s = self impedance
 Z_m = mutual impedance
 M = number of phases.

The same equations hold for the capacitance matrices,

$$C_0 = C_s + (M-1) \cdot C_m, \text{ etc.}$$

4.2 LUMPED SERIES RESISTANCE IN LINE

To approximate losses in the lossless line representation, the TRANSIENTS program lumps $R/4$ at both ends and $R/2$ at the middle of the line (except when line is assumed to be distortionless), where

$$R = R' \cdot \ell \tag{6}$$

with R' = resistance per unit length
 ℓ = length of line.

A justification for lumping the series resistance was given by C. Boonyubol and C. Galabrese, "Equivalent distributed-parameter simulation for transient study of a transmission line". Conference paper, IEEE Summer Power Meeting, Chicago, June 1968. The authors lump the resistance at the sending end; it is computed from

$$R_{\text{equivalent}} = Z \cdot \tanh \left(\frac{R' \ell}{Z} \right), \tag{7}$$

where Z = surge impedance.

The line is then treated as lossless as in the TRANSIENTS program.

Obviously, R from (6) and $R_{\text{equivalent}}$ from (7) are not identical. Since $R' \ell \ll Z$, one can develop the hyperbolic tangent into a series,

$$\tanh\left(\frac{R' \ell}{Z}\right) = \frac{R' \ell}{Z} - \frac{1}{3} \left(\frac{R' \ell}{Z}\right)^3 + \frac{2}{15} \left(\frac{R' \ell}{Z}\right)^5 \pm \dots$$

If only the first term is retained in the series, then

$$R_{\text{equivalent}} \approx R' \ell.$$

Therefore, $R_{\text{equivalent}}$ is approximately the same as R from (6).

If $Z = 330 \Omega$ and $R' \ell = 12 \Omega$ (typical values*), then

$$\tanh\left(\frac{R' \ell}{Z}\right) = 0.0364 - 0.000016 \pm \dots$$

The error by neglecting the third-order and higher terms is about 0.04%, which is extremely small.

* These are typical values for the positive-sequence mode, but not necessarily representative of the zero sequence, particularly at higher frequencies. Therefore caution must be exercised in lumping the resistance should $R' \ell$ no longer be small compared with Z . Of course exact representation of the zero sequence mode is now possible using the frequency-dependence option (see Section 1.27).

5.0 INTERACTIVE CRT PLOTTING OF EMTF SOLUTIONS

Let's begin by making it clear what this section is not about. Requests for graphs of EMTF output variables can be included along with the data case which defines and solves the problem of interest (see Section 1.10). Or, such plot requests can be split off into a separate follow-up "REPLOTT" job (see Section 1.0d). Either way, this is batch-mode EMTF plotting, which is not what now concerns us.

5.0A Interactive CRT Plotting

More powerful, efficient, and flexible is interactive CRT plotting of EMTF output variables. As with the "REPLOTT" option, the plotting of a previously-solved EMTF data case is involved. But rather than submit the plot requests as a pre-defined job, here the user sits down before a vector-graphic CRT terminal and does his plotting in real time. Attributes of such interactive CRT plotting include the following:

- * Speed. A graph is produced in seconds. Then too, one is not slowed down by a backlog on the conventional plotter (which may be hours, typically).
- * Data errors are no problem, since they are discovered experimentally and can be corrected in seconds.
- * The user is not required to know ahead of time what he should be looking for or at. A survey of problem performance can be made experimentally, by trial and error, learning as one looks.
- * The time scaling can be experimentally adjusted by eye so as to produce pleasing results which properly display the phenomena of interest.
- * If the user likes what he sees on the screen, a hard copy unit can produce a paper copy in seconds. One also can dispatch plots to the pen-and-ink plotter (although these might not be available for hours, remember).

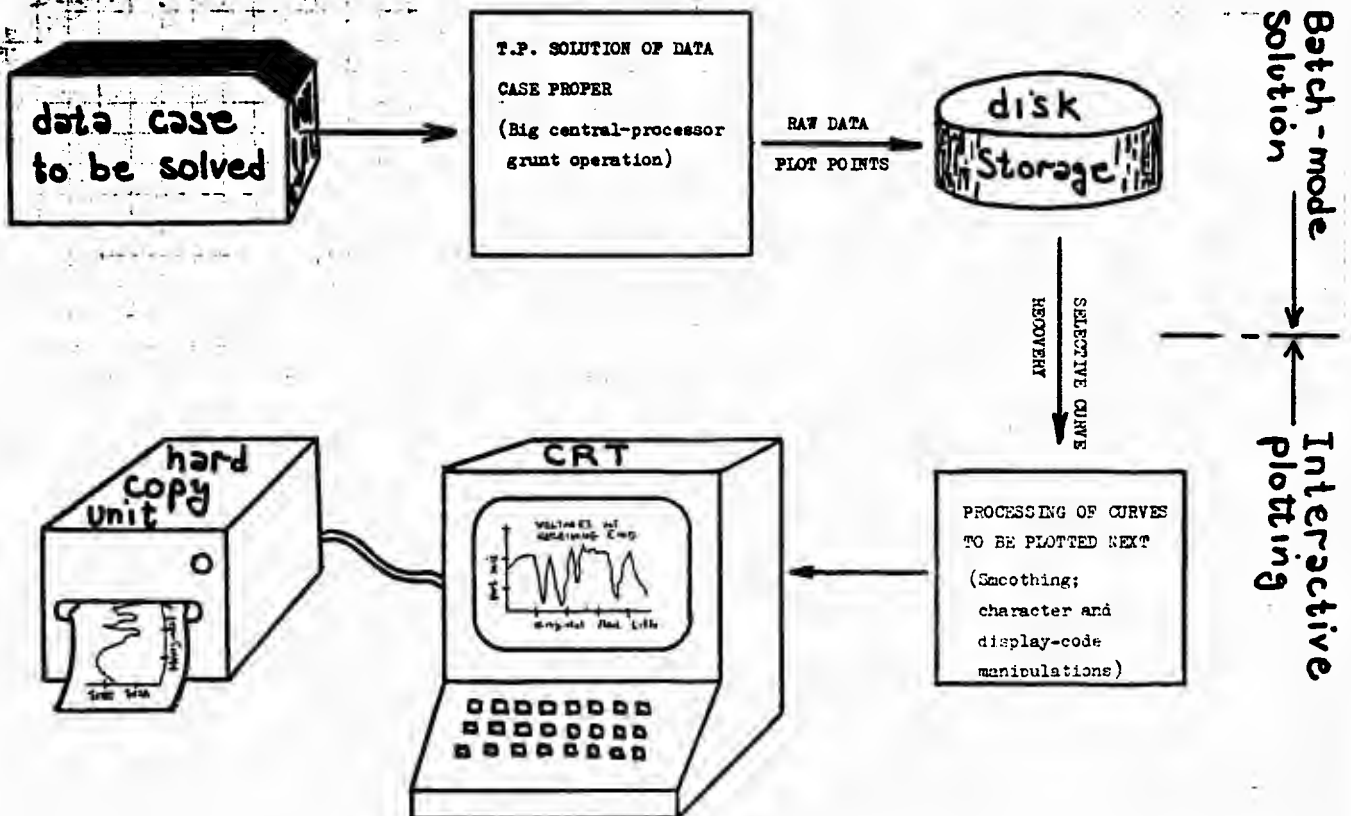

So much for the summary description. Interactive CRT plotting of EMTP results is more fully described in two EMTP memoranda of Ref. 8, Vol. II. The 10-page memo dated November 25, 1974 describes the concept, and shows samples of hard-copy output; that dated January 25, 1975 provides 13 pages of user instructions for the interactive CRT plotting procedure as used at BPA. There have been a few extensions and refinements made since then, but the basic concept and format remains intact. As of July, 1977, the BPA interactive CRT plotting program is tied to both a Control Data 6000-Series computer, and also to a Tektronix CRT terminal. The program is small (perhaps 1000 FORTRAN cards), but is both machine and screen-dependent.

Interactive CRT plotting has been a tremendous success with EMTP users at BPA, with perhaps 95% of all EMTP plotting now being done by this means. It is only for published papers or final reports that the pen-and-ink plotter continues to enjoy regular EMTP patronage.

Then in February of 1979, BPA bought a DEC VAX-11/780 computer system (see Section 0.5h), and all EMTP usage was switched from CDC to this system. The interactive plotting program was then enhanced at that time (see 28-page memo of Ref. 8, Vol. IX, 11 May 1979, pagination PIEP), and is now about 2400 cards in size. It should work successfully with any Tektronix vector-graphic terminal which can be driven by the user's Tektronix PLOT10 plotting package (proprietary with Tektronix, though priced very reasonably; most users of a Tektronix terminal already have this). At BPA we still just drive a big-screen (19-inch) 4014, while Ned in Minneapolis (see Section 0.5a) plots remotely on a cheap, small-screen 4006 via a 300 baud telephone connection to our VAX. The optional COPY command of interactive plotting will dispatch a copy of what is on the screen to the system plotter only if the user also has a CalComp plotting interface (subroutines "LINE", "SYMBOL", "AXIS", etc.).

It is hoped that the BPA VAX interactive plotting program may soon be available for execution on other computer systems. The most important of these is IBM, of course. Mike Price of AEP was interested in converting the package for use on the AEP IBM 3033, so it was sent to him on tape the morning of March 13th, 1980. Whether this might be available when new EMTP versions are distributed during the summer of 1980 can not be predicted at this time (late April, 1980). If an IBM user is interested, all he can do is inquire at the time. See Section 0.5b for Mike Price's telephone number.

5.0C Format of EMTP Plot Data Points on "LUNIT4"

The EMTP writes output variables on logical unit number "LUNIT4" during the solution process (in the time-step loop of overlay number 16). Before entering the time-step loop (in overlay 15), either two or three records of header information are first outputted. It is the precise format of this "LUNIT4" file which shall now be described. For a conventional (not TACS-only) data case:

First Record:

DATE1(2) ----- 8-character BCD specification of the date that the solution was generated. It is to be printed out as 2A4 information, which might then look like "10/26/74". Two EMTP "ALPHANUMERIC" words are involved, the mode and/or length of which is machine dependent. See Program Maintenance for details.

TCLOCK(2) ----- 8-character BCD specification of the wall-clock time at which the solution was begun. It is to be printed out using 2A4 format, producing a result looking something like "13.42.07".
Two EMTP "ALPHANUMERIC" words are involved, the mode and/or length of which is machine dependent. See Program Maintenance for details.

NTOT ----- The number of A6 alphanumeric names which constitute the end of this first record. For EMTP usage, this is the number of problem nodes.

NUMNVO ----- The number of type-1 plot variables in the plot file. For EMTP usage, this is the number of node voltage outputs of the case in question.

NUMBCO ----- The number of type-9 plot variables in the plot file. For EMTP usage, this is the number of branch-current outputs.

NC ----- The number of type-8 and type-9 plot variables in the plot file. For EMTP usage, this is the total number of branch outputs for the solution in question, both branch currents and branch voltages.

(BUS(I), I=1, NTOT) ----- A6 alphanumeric names by which plot variables are identified. For EMTP usage, this is the complete list of network node names (including ground, which is node number 1, having 6 blank characters for its name).
A vector of EMTP "ALPHANUMERIC" words is involved, the mode and/or length of which is machine dependent. See Program Maintenance for details.

The term "ALPHANUMERIC" might be documented further (see definition of DATE1, TCLOCK, and BUS). By definition, such variables are used to store A6 information (e.g., node names). For conventional byte-organized machines like IBM, PRIME, VAX, and SEL, such variables are of type REAL*8. For most word machines like CDC and Honeywell, they are of type INTEGER.

Next Record (#2, if it exists)

If parameter NUMNVO as read from record number 1 is positive, then the second record of header information contains integer numbers which identify each type-1 plot variable in the data file:

(IBSOUT(I), I=1, NUMNVO)

To find the A6 name of the corresponding type-1 variables in the output file, these integers are used as subscripts of array BUS.

For EMTP usage, $K = \text{IBSOUT}(I)$ is the node number of the I-th node-voltage output quantity. The 6-character node name is BUS(K).

Should NUMNVO be zero, the aforementioned record is nonexistent.

Final Header Record (if it exists)

If parameter NC as read from record number 1 is positive, the next record to be read specifies integer numbers identifying type-8 and type-9 plot variables within the plot data file. This record has contents:

$$(\text{IBRNCH}(L), L=1, NC), (\text{JBRNCH}(L), L=1, NC)$$

Both type-8 and type-9 output variables are identified by a pair of alphanumeric (actually BCD; A6 format, in any case) names. Corresponding integers from the two listed arrays are used as subscripts to array BUS in order to obtain the pair of identifying names.

For EMTTP usage, $I = \text{IBRNCH}(L)$ and $J = \text{JBRNCH}(L)$ are the terminal node numbers corresponding to the L -th output branch quantities. The 6-character node names of the ends of the branch in question then are $BUS(I)$ and $BUS(J)$.

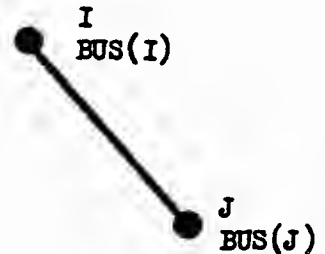

If NC should be zero, the just-mentioned record is nonexistent.

Records Containing Actual Data Points of Output Variables

The preceding header records (two or three in number) are followed by records which specify the numerical plot coordinates of all output variables. A separate record exists for each time-point t_1 , containing not only the time value, but also the corresponding numerical value of all output variables:

$$T, (\text{VOLTI}(L), L=1, \text{NUMOUT})$$

$$NC + \text{NUMNVO}$$

where

T ----- the time in seconds at which all output quantities of this record correspond.

$\text{VOLTI}(L)$ ----- The numerical value for the L -th output quantity, at time T . Within this output vector, all type-1 variables (if any) come first, followed by all type-8 variables (if any), followed by all type-9 variables (if any).

These records must occur in order of monotone-increasing time T .

The termination of plot data points is indicated by a record such as the above, having time coordinate set to $T = -9999$. This is just a convenient termination flag.

For EMTTP usage, of course type-1 variables are node voltages, type-8 variables are branch voltages (or powers), and type-9 variables are branch currents (or energies). Thus the stated ordering says simply that node voltages come first, then branch voltages (or powers), and finally branch currents (or energies). Recall that TACS variables and dynamic synchronous machine variables are treated just like they were branch currents, as far as plotting is concerned (i.e., they too are type-9 variables). The same is true of the universal machine (U.M.) variables (also type-9 plotting).

As for the TACS-only stand-alone case, the header records have a little different form. The First Header Record is altered in that (see end of "TACS1A" definition):

- a) NTOT and NUMNVO are replaced by IOUTCS, which is the number of TACS output quantities.
- b) NUMBCO and NC are given values of zero, always, which means that there are no branch outputs (Type-8 or Type-9 variables).
- c) BUS(I) node names are replaced by the vector of TACS output variable names, (ALNOUT(I), I=NDX1, NDX2).

The Second Header Record simply consists of the ordered positive integers 1, 2, ..., IOUTCS. Finally, there is no Third Header Record.

TPPLOT Instructions

User instructions for TPPLOT were first published in EMTP Memoranda, Volume IX. Although dated, these remain valuable & in demand by beginning users. The 28 pages ("PIEP" pagination) follow as an insert (see next page):



Date: 11 May 1979

To : Listed addressees

From: W. Scott Meyer
BPA, Route EOGA
P. O. Box 3621
Portland, Oregon 97208
Phone: (503) 234-3361
Ext. 4404

Dr. Hermann Dommel, Prof., Univ. of B.C., Vancouver, CANADA
Luiz Mauricio Leuzinger, FURNAS, Rio de Janeiro, BRAZIL
Dr. Arun Phadke, AEP Service Corp., New York, N.Y.
Roger LeVesque, General Public Utilities, Reading, Penna.
Dr. Akihiro Ametani, Prof., Doshisha Univ., Kyoto, JAPAN
Russell Brierley, Ontario Hydro, Toronto, CANADA
Dr. Kurt Fehrle, General Electric, Philadelphia, Penna.
Fernando Chacon, INIE, Lima, PERU

BPA, EOGA ---- Dr. Tsu-huei Liu (library copy)
BPA, EOGB ---- Alvin Legate & Bob Hasibar
BPA, EOHC ---- Herb Konkel

TRANSIENTS PROGRAM MEMORANDUM

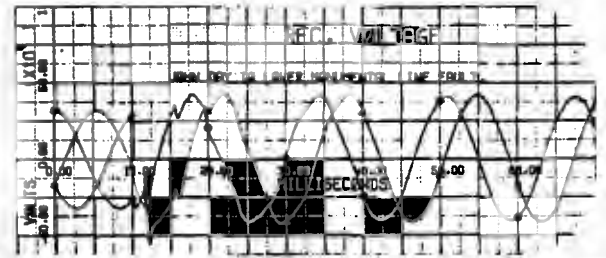

SUBJECT : Progress in EMTP plotting (particularly the all-new VAX-Tektronix-CalComp interactive plotting package).

Background of EMTP Plotting

A CalComp plotting package has been part of the EMTP for a decade or more now. This was batch-mode plotting (originally written by John Walker for Hermann, I believe), which underwent substantial enhancement nearly four years ago (see Vol. III EMTP memoranda dated 28 August 1975 and 9 September 1975). Occasionally improved and/or extended in the interim (e.g., see Vol. VIII EMTP memoranda dated 24 April 1978 page PNVD-10, 17 September 1978 page CTTE-11, Point T, and 27 January 1979 pages PROV-9 and 17), this overlay-31 code remains an integral and important part of the EMTP. However, we shall not be preoccupied with such batch-mode plotting in this memo.

Interactive EMTP plotting began four and a half years ago (see Vol. II EMTP memoranda dated 25 November 1974 and 25 January 1975). Using both old small-screen and newer large-screen Tektronix CRT terminals, this vector-graphic plotting was powered by the BPA CDC-6500 and Cyber-71 (CDC-6400) computer systems. It has been the work horse of production EMTP plotting for several years now.

New Interactive EMTP Plotting Package for VAX-11/780

Then early this year, a discontinuity occurred. With the acquisition of our EMTP-dedicated DEC VAX-11/780 computer system (see Vol. VIII EMTP memo dated 19 November 1978), the potential for interactive EMTP dialogue was greatly enhanced.

Consider the attributes which affect plotting:

PIEP-2

- * near-instant response (delay is small compared with the speed of human perception);
- * rapid data transfer (all VAX terminals are being driven at 9600 baud, eight times faster than the old CDC support for the Tek 4014;
- * direct access to a printer/plotter (Item 6 on page ABBO-3).

Clearly, the old assumptions and concepts about interactive EMTP plotting were worthy of total re-examination at this point. There had to be substantial changes anyway, since the old interactive plotting FORTRAN was strongly a function of the Control Data host computers.

For the past six or eight weeks, VAX interactive EMTP plotting has been my major preoccupation. The initial, primitive conversion from CDC to VAX provided only for character-type (line-printer-type) CRT plots, and this was done in about a week. Since then, the program (named TPLOT) has been totally restructured, and considerably expanded (from 800 or so cards to more than 2000 at present); and it provides vector-graphic plotting on both the Tektronix 4014 CRT terminal and the Versatek printer/plotter. User instructions for this new package will be found on following pages. Such is the real raison d'être of this memo : communication of vital user-oriented information to interested parties.

I should perhaps mention that there has not been any great improvement in universality of the interactive plotting program TPLOT. Before, the code was strongly dependent upon CDC; now, it is dependent upon VAX! But on the positive side, the dependence now is considerably more superficial, concentrated in input/output (e.g., free-format READs and WRITEs using "*", use of "\$" to suppress carriage returns at the end of FORMAT statements, and of course the familiar DECODE). But the number of such usages is not small. If those having other computer systems want the code, they must take it as-is, at their own risk.

A few words about the Versatek and CalComp connections are appropriate. We are using a CalComp plotting interface for the Versatek, so there is substantial universality here. There also are some inconveniences, though I shall not detail them at this time. Driving of the 4014 is done via Tektronix's inexpensive PLOT 10 Terminal Control System (TCS) software. I am happy to be able to acknowledge the assistance of Mr. Walt Dixon of General Electric in Schenectady, who aided us in making the package operational here at BPA. Walt has had previous PLOT 10 experience (on a PDP-11, I believe), and he made the package operational on their own VAX some time ago (only a few short installation-dependent modules need be written). Here at BPA, Frank Orem handled necessary operating system settings (SET TERMINAL/PASSALL/LOWERCASE), which took some experimentation.

What about future work on interactive plotting? There is the case of our DEC VT100 terminal (see Item 8 on page ABBO-4 of the Vol. VIII EMTP memo dated 19 November 1978). While not truly vector-graphic in the sense of Tektronix, this terminal does allow plotting which is substantially better than the conventional character plots. When we acquire two more such terminals, a special plotting module will probably be written to exploit this capability, thereby ending our development of interactive plotting.

A more radical and important advance would be to generalize interactive plotting so as to allow the plotting of solutions as they are being generated. Such real-time plotting might be limited to Tektronix terminals (where the storage-tube process could be exploited). The idea is simple, though details remain to be worked out (we have yet to experiment with the sharing of data by two distinct programs). A time frame for work on this project can not be predicted at the present time.

A. Structure of TPLOT-User Dialogue

The VAX interactive EMTP plotting program is named TPLOT. This name will be used frequently, so remember it.

TPLOT is used to interactively plot variables of a previously-solved EMTP data case, as described in Section 5.0A of the EMTP User's Manual. The file of raw plot data points exists on disk, recall, if integer miscellaneous data parameter "ICAT" was punched positive (Section 1.0h of the User's Manual). Any CRT terminal or typewriter terminal can be used, if only character-type (line-printer-type) plots are required, with the time axis running down the screen (hence of arbitrary length). Typical typewriter terminals like our DECwriter are maddeningly slow (300 baud) for this usage, however. If a Tektronix vector-graphic CRT is available (e.g., our Tek 4014), then high-resolution plotting is possible. Finally, if and when the user likes what he sees, a "COPY" command will batch a copy of the plot to a CalComp-compatible plotting device which may be connected (the 11-inch, 200 dots/inch printer/plotter of ours at BPA).

There are three levels of communication with TPLOT : OUTER, MIDDLE, and INNER. Different dialogue is possible (or required) at each level. Program execution always begins with the OUTER level, where terminal parameters and a plot data file are specified. With MIDDLE level dialogue, all plot variables and plot-related text are specified. Finally, INNER level dialogue involves specification of the time span of interest, various minor decisions, and the actual command to produce a plot. The exact form of the TPLOT prompts for these three levels of dialogue are:

?? OUTER : ?? MIDDLE : ?? INNER :

The first question mark will always begin in column number one.

In response to the just-described prompts, the user must supply a key word, or sometimes a very specific item of data. Examples of valid OUTER level responses are:

"SET DATA" "DEBUG" "PUNCH" "15.25.42"

The first three of these are key words (see page for a complete list), while the last item is the time specification of a plot data file which has been created by previous EMTP solution. If the user sends a key word, TPLOT will many times respond with further explanation, should additional information be required. For example, if the user sends "DEBUG", TPLOT might typically respond with the message reading "SUPPLY LEVEL NUMBER IPRSUP (0) :". The value within the parentheses is the current level number (shown here as zero, meaning that there is currently no diagnostic printout).

The format of user-responses is easily summarized. The key-word responses are all fixed-format (A8 field specification), while numerical data is almost all free-format. The VAX FORTRAN compiler allows either a comma (",") or one or more contiguous blank characters to be used for purposes of field separation. This is illustrated in numerous later examples. Unlike for fixed-format data, then, a user must explicitly punch at least one non-blank character for each data item that is requested. The computer terminal will simply wait as if in hibernation until the full string has been sent. A further description of VAX free-format rules and properties can be found on pages 7-11 through 7-13 of the DIGITAL VAX-11 FORTRAN IV-PLUS Language Reference Manual dated August, 1978.

The exact spelling of key words can be confusing, sometimes, for each user is allowed to assign his own abbreviations when then over-ride the inherent built-in names. For example, a standard MIDDLE level key word is "TIMESPAN" (which represents a request of TPLOT to find the time range of the data on the attached plot data file). But rather than always typing these eight characters, it is quicker to use an abbreviation such as "TS" instead. This specific case will be seen in several of the illustrative examples. The abbreviations are all defined by the user in a file which is ASSIGNED to FOR030 before execution begins, and are then actuated by a "SET DATA" request during OUTER level dialogue. A very large number of program parameters (about 150 in number) can be so tailored to user needs. See Program Maintenance if there are questions, and of course read the rules about this feature on page 13.

With Tektronix CRT plotting, there is the problem or issue of screen erasure. Only one erasure is automatic --- that which precedes the drawing of the first graph of the plotting session. It is the user's responsibility to erase the screen manually before all subsequent plots, if this is what is really desired (often it is not).

B. Example of Tektronix 4014 Plotting

Before delineating any more rules, let's consider an actual example of interactive CRT plotting using the Tektronix 4014 terminal with attached hard copy unit (which was used to take pictures of the screen for all examples below). Before erasure of the screen (the automatic erasure which precedes the first plot), the dialogue between TPLOT and the user looked as follows:

```

Username: SCOTT
Password:
Welcome to UAX/UMS Version 1.01
      8-MAY-1979 00:00:38
$ ASSIGN TPPARAM.DAT FOR030
$ RUN TPLOT
?? OUTER :SET DATA
SEND SUBSET NUMBER :1
?? OUTER :M/DD HH.MM.SS
CONFIRMATION : 03/16/79 13.47.56
?? MIDDLE :TS
DATA TIME LIMITS, IN SECONDS : 0.62832E-02 0.62832E+01
?? MIDDLE :
SEND NODE NAME OR END ( ) :NODE1
SEND NODE NAME OR END ( ) :NODE2
SEND NODE NAME OR END ( ) :END
SEND BRANCH VOLTAGE NAMES OR END ( , ) :NODE1 NODE2
SEND BRANCH VOLTAGE NAMES OR END ( , ) :LAST
SEND SUPER-TITLE ( ... ) :REPEAT
?? INNER :
```

While not an exhaustive list, a number of comments about this dialogue might be pointed out:

- P1. I covered up the password which was user typed, for security reasons. It does show on the screen of our 4014, unfortunately (all other terminals do not echo it).

- P2. The first Digital Command Language (DCL) response of the user was to connect a file of parameter definitions (named TPPARAM.DAT) to unit 30. The subsequent RUN command begins execution of TPLOT. All later dialogue is with TPLOT, rather than with the operating system (VAX/VMS).
- P3. The user request for "SET DATA" at the OUTER level of dialogue was responded to by TPLOT with a request for a further characterization ("SEND SUBSET NUMBER"). This is because the data file in question can have an arbitrary number of separate, complete sets of TPLOT parameters. Here the user chose to use the first set of the file.
- P4. The next OUTER level item sent by the user is the name of the file which stores the raw plot data points. All characters other than letters and numbers are ignored by TPLOT, so the file name in question is actually "MDDHHMMSS". This is a small, artificial test file of four variables and 1000 time points, which is kept on the system for illustration and test purposes only. TPLOT will signal successful connection of the data file by printing "CONFIRMATION :", followed by the date and the time which are built-in header information of the file (fully documented in Section 5.0C of the User's Manual). This will normally be the date and time when solution of the data case in question began. Finally, note that there is an automatic transfer to MIDDLE level dialogue by TPLOT, at this point.
- P5. As mentioned before, "TS" is a user-defined abbreviation for "TIMESPAN" --- a request for the determination of beginning and ending times of the data file. If the user does this, then plots can subsequently be produced without explicit specification of time limits; a plot over the full range of time will then result.
- P6. The second MIDDLE level user response nothing --- just a carriage return. Any response other than a valid MIDDLE level key word leads to the dialogue associated with plot variable and plot text specification. First come node voltages, then branch voltages, and finally branch currents, exactly as with EMTP time-step printout. The user is allowed as many of each class of variables as desired. Each class is terminated by sending "END", while "LAST" will terminate all variable input at any of the three stages of input (here the use of "LAST" is equivalent to "END" only when applied to the branch-current input). The parentheses display previously-used names (here blank, since there was no previous plot), which can be reused by sending a blank. But this feature is not illustrated in the present example.
- P7. After specification of plot variables is complete, TPLOT then asks for plot text, one item at a time. Again, parentheses display the old text (blank in this example). Such input begins with the one-line super title. The user response "REPEAT" serves to skip over all such input, reusing the old values (initially blank). There is then an automatic transfer to INNER level dialogue by TPLOT.
- P8. Finally, the user sent nothing (carriage return only); since not a legitimate INNER level key word, this is taken as the signal by TPLOT for a plot. Because this is the first plot, there will be a subsequent screen erasure, followed by the plot on the next page:

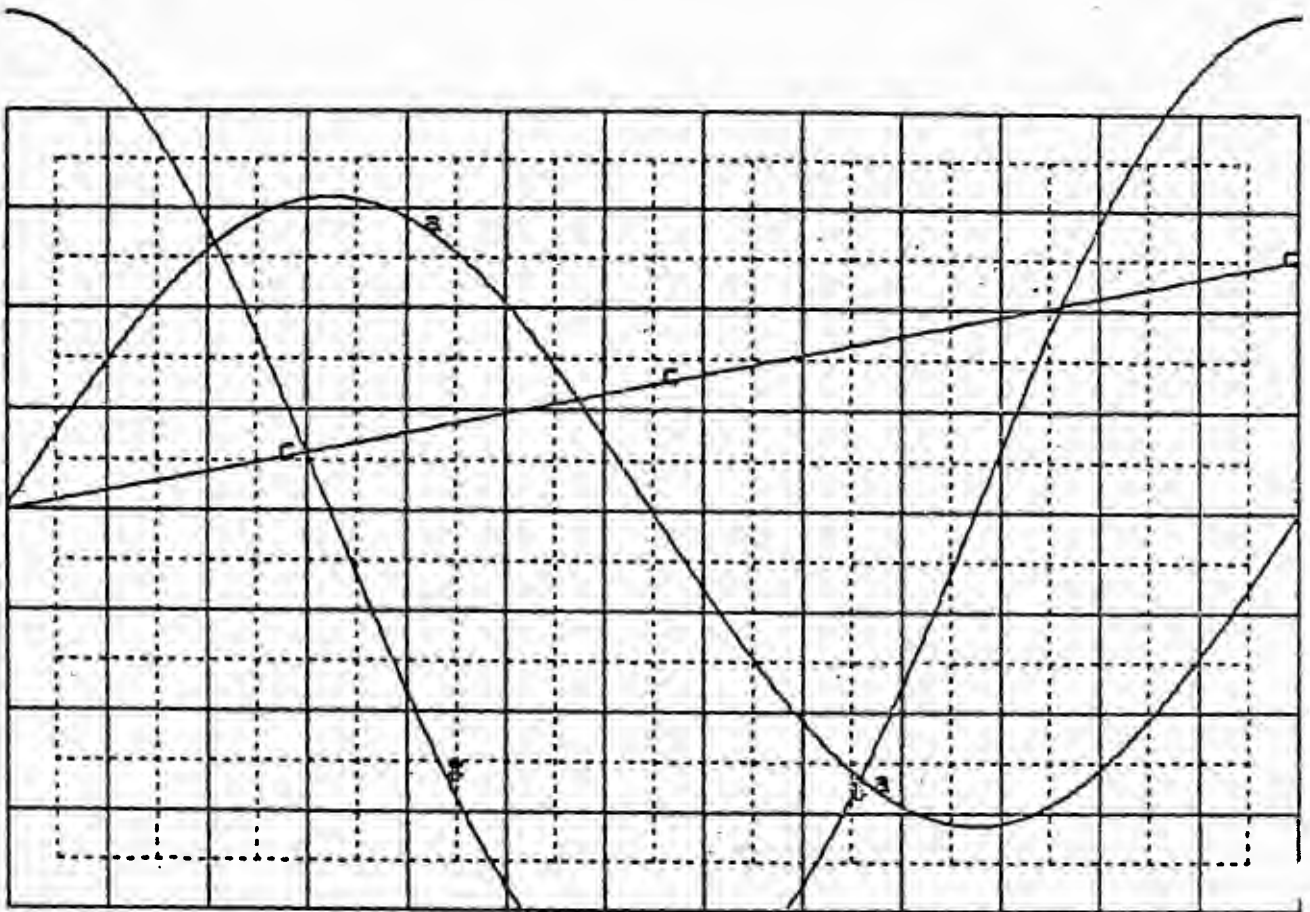

```

FILE : 03/16/79 13.47.56
NAMES : NODE1 NODE2 NODE1 NODE2
YMIN, YMAX, DY/IN = -0.1000E+02 0.1000E+02 0.2500E+01
XMIN, XMAX, DX/IN = 0.62832E-02 0.62832E+01 0.48284E+00
?? INNER :

```

- P9. There are two background grids, each with one inch spacing. Here the inner grid has been set for dashed lines, due to "SET DATA" usage. This is aesthetically pleasing, but much slower than use of all-solid grid lines.
- P10. Curves are labeled with ASCII symbols. Default labeling uses "a" for the first curve, "b" for the second, etc. But here "#" has been used for the second curve (again due to "SET DATA" usage).
- P11. Plot identification is presently limited to the text in the lower left-hand corner. It is the user's responsibility to remember that the third curve is a branch voltage and not a branch current. The string of variable names is printed in the order of input --- but that is the limit to variable characterization at the moment.
- P12. INNER level dialogue is resumed when the plot is complete. This finishes the simple illustration.

C. Complete Tabulation of Key Words of TPLOT

At each of the three levels of TPLOT dialogue, the user can type "HELP" in order to see a directory of all possible responses. A complete listing of this display is shown on the following three pages.

SUMMARY OF OUTER-LEVEL RESPONSES :

SET DATA -- TO OVER-RIDE DEFAULT DATA VALUES WITH USER-ESTABLISHED CHOICES. THIS USER-ESTABLISHED DATA FILE MUST PREVIOUSLY BE ASSIGNED TO UNIT 30.

PURGE -- TO DESTROY THE PLOT DATA FILE THAT IS CURRENTLY CONNECTED.

TEK ---- TO TOGGLE THE SWITCH WHICH DECIDES BETWEEN PRINTER (CHARACTER) PLOTTING AND VECTOR-GRAPHIC (TEXTRONIX) PLOTTING.

DEBUG -- TO ALTER (E.G., TO TURN ON) THE LEVEL OF DIAGNOSTIC PRINTOUT.

COLUMN -- TO TOGGLE THE SWITCH THAT CHOOSES BETWEEN 80 AND 132-COLUMN PRINTER (CHARACTER) PLOTS.

SET COLUMN-- TO SET THE COLUMN-WIDTH OF PRINTER PLOTS (USED IF NOT 80 OR 132).

STOP --- TO TERMINATE EXECUTION (BACK TO \$-MODE OF DCL INTERPRETER).

PUNCH -- TO DEFINE (CHANGE) THE I/O UNIT NUMBER OF THE CARD-PUNCH FILE.

PRINTER-- TO DEFINE (CHANGE) THE I/O UNIT NUMBER OF THE LINE-PRINTER FILE.

STACK --- TO OBTAIN A DISPLAY OF DATA FILES WHICH ARE AVAILABLE FOR PLOTTING.

LONGER -- USED TO REDEFINE (E.G., INCREASE) THE MAXIMUM TOTAL LENGTH OF CALCOMP (VERSATEK) PLOTS WHICH RESULT FROM \$COPY\$ COMMANDS.

IN ---- TO TRANSFER DIRECTLY TO MIDDLE LEVEL OF PROGRAM DIALOGUE.

HELP --- TO PRODUCE THE DISPLAY NOW BEING VIEWED.

HMMSS -- FILE SPECIFICATION FOR PLOTTABLE DATA FILE. HERE A SYMBOLIC REPRESENTATION FOR THE 6 DECIMAL DIGITS OF THE TIME OF DAY HAS BEEN USED. A PRECEDING DIRECTORY NAME (IN SQUARE BRACKETS) IS OPTIONAL, AS IS THE MONTH (ONE HEX DIGIT) AND THE DAY OF THE MONTH (2 DECIMAL DIGITS). THE MONTH OR DAY IS REQUIRED IF DIFFERENT THAN TODAY. SEPARATOR CHARACTERS (INCLUDING BLANKS) ARE ALLOWED, EXCEPT WITHIN THE DIRECTORY NAME. AN EXAMPLE: [ESCOTT] 4/29 22.39.06 . PROGRAM RESPONSE WILL BE THE OPENING OF THIS FILE ON UNIT-14, FOLLOWED BY THE AUTOMATIC TRANSFER TO THE MIDDLE LEVEL OF DIALOGUE (IMPLICIT \$IN\$).

SUMMARY OF MIDDLE-LEVEL RESPONSES :

IN ---- FOR DIRECT TRANSFER TO INNER LEVEL OF PROGRAM DIALOGUE.

TIMESPAN-- TO BE SHOWN THE TIME RANGE OF THE CURRENT PLOT DATA FILE.

CHOICE -- TO PRODUCE A TABULATION OF PLOTTABLE EMTF VARIABLES.

STOP --- TO TERMINATE EXECUTION (BACK TO \$-MODE OF DCL INTERPRETER).

PURGE -- TO DESTROY THE PLOT DATA FILE THAT IS CURRENTLY CONNECTED.

HELP --- TO PRODUCE THE DISPLAY NOW BEING VIEWED.

OUT --- FOR DIRECT TRANSFER TO THE OUTER LEVEL OF PROGRAM DIALOGUE.

TIME UNITS-- TO SPECIFY THE INTEGER WHICH CHARACTERIZES USER-DESIRED TIME UNITS. THIS IS JUST AS WITH EMTF BATCH-MODE PLOTTING, WHERE \$1\$ MEANS DEGREES, \$2\$ MEANS DEGREES BASED ON 60 HERTZ, \$3\$ MEANS SECONDS, \$4\$ MEANS MILLISECONDS, AND \$5\$ MEANS MICROSECONDS. CODE NUMBERS \$6\$ AND \$7\$ ARE FOR \$FREQUENCY SCAN\$ DATA CASES, FOR HERTZ AND LOG TO THE BASE 10 OF HERTZ RESPECTIVELY.

X ----- ANY GARBAGE CHARACTER, INCLUDING BLANK, REPRESENTS A REQUEST FOR THE PROGRAM TO BEGIN THE INTERROGATION FOR PLOT VARIABLES, AND PLOT LABELS. HEREAFTER, IN RESPONSE TO THE QUESTIONS, SEVERAL SPECIAL, LOCAL KEY WORDS ARE APPLICABLE :

- REPEAT : TO RE-USE ALL OLD PLOT LABELING, SEND \$REPEAT\$ WHEN FIRST INTERROGATED FOR LABEL INFORMATION (WHICH BEGINS WITH THE SUPER TITLE).
- BACK : TO ABORT THE INPUT OF VARIABLES, AND RETURN TO THE MIDDLE-LEVEL OF DIALOGUE.
- END : TO TERMINATE INDETERMINATE VARIABLE INPUTS. INCLUDED ARE THE THREE CLASSES OF VARIABLES AND THE LINES OF CASE-TITLE TEXT.
- LAST : TO TERMINATE ALL PLOT-VARIABLE INPUT, SEND \$LAST\$. GRAPH LABELING INPUT WILL THEN BE REQUESTED NEXT.
- BLANK : SENDING NOTHING (A BLANK) WILL USUALLY RE-USE THE OLD DATUM (E.G., NODE NAME, OR LINE OF CASE-TITLE TEXT). OLD DATA IS USUALLY DISPLAYED WITHIN PARENTHESES FOR THIS REASON.
- FLUSH : TO REWIND THE POINTER WHICH COUNTS LINES OF CASE TITLE. THE TEXT REMAINS, TO BE ACCEPTED OR REJECTED LINE BY LINE.
- PLAYBACK: TO HAVE DISPLAYED THE PRESENT CASE TITLE. THIS CAN BE DONE AT ANY POINT BEFORE THE \$END\$ WHICH FREEZES THE CASE TITLE.

UPON COMPLETION OF THE RESPONSES TO QUESTIONS OF THIS GENRE, THERE IS AN AUTOMATIC SWITCH TO INNER-LEVEL DIALOGUE.

LABEL -- TO SKIP AROUND THE PLOT-VARIABLE SPECIFICATION (REUSING THE OLD SET), AND BEGIN THE INPUT OF PLOT LABELS (THE SUPER-TITLE COMES FIRST).

SUMMARY OF INNER-LEVEL RESPONSES :

- STOP --- TO TERMINATE EXECUTION (BACK TO \$-MODE OF DCL INTERPRETER).
- HELP --- TO PRODUCE THE DISPLAY NOW BEING VIEWED.
- DEBUG -- TO ALTER (E.G., TO TURN ON) THE LEVEL OF DIAGNOSTIC PRINTOUT.
- OUT --- FOR DIRECT TRANSFER TO THE MIDDLE LEVEL OF PROGRAM DIALOGUE.
- MESSAGE-- TO SEND AN ARBITRARY EXPLANATORY MESSAGE TO THE LINE PRINTER. AN ARBITRARY NUMBER OF 80-COLUMN LINES MAY FOLLOW, TERMINATED BY \$END\$.
- BATCH -- TO CREATE EMTF BATCH-MODE PLOT CARDS CORRESPONDING TO THE LAST PLOT. THESE ACCUMULATE IN THE CARD-PUNCH FILE.
- EXTREMA-- TO TOGGLE THE SWITCH WHICH DECIDES WHETHER OR NOT VARIABLE EXTREMA OF SUBSEQUENT PLOTS ARE TO BE PRINTED. SUCH OUTPUT PRECEDES THE ASSOCIATED PLOT (AS DOES THAT OF \$LEVEL\$ BELOW). THE PROGRAM THEN PAUSES BEFORE DRAWING THE GRAPH, WAITING FOR THE USER TO SEND A BLANK. OTHER POSSIBLE RESPONSES ARE \$LINE\$ TO PRODUCE A LINE PRINTER COPY OF THE EXTREMA AND LEVEL CROSSINGS, OR \$NO PLOT\$ TO SKIP THE SUBSEQUENT PLOT (AND RETURN TO MIDDLE-LEVEL DIALOGUE).
- LEVEL -- TO TOGGLE THE SWITCH WHICH DECIDES WHETHER OR NOT VARIABLE LEVEL TRIGGERS ARE TO BE ACTIVATED. IF SUCH ARE BEING TURNED ON, THE PROGRAM WILL RESPOND WITH A REQUEST FOR A LEVEL VECTOR (FREE FORMAT). READ \$EXTREMA\$, TOO.
- SMOOTH -- TO REDEFINE THE TOLERANCE WHICH IS USED TO DISCARD PLOT POINTS.

- SIZE -- TO REDEFINE THE TIME-AXIS LENGTH OF THE PLOTS.
- SHOW -- TO DISPLAY THE CURRENT VALUES OF MANY RELEVANT PLOT PARAMETERS.
- LINE -- TO DISPATCH THE JUST-COMPLETED PRINTER (CHARACTER) PLOT TO THE LINE PRINTER.
- COPY -- TO DISPATCH THE JUST-COMPLETED PLOT (EITHER PRINTER OR TEK) TO THE CALCOMP (VERSATEK) PLOTTER. THE PROGRAM WILL RESPOND WITH A REQUEST FOR A REVISED TIME-AXIS SCALING, AT WHICH POINT SEVERAL SPECIAL, LOCALIZED REQUEST WORDS ARE POSSIBLE :
- PEN : TO ADJUST THE WIDTHS OF VARIOUS LINE AND TEXT STRUCTURES OF THE GRAPH. SUPPRESSION OF MOST SUCH STRUCTURES IS AN OPTION, TOO.
- SIZE : TO ADJUST VARIOUS FLOATING-POINT VALUES OF THE PLOT (TEXT SIZE AND LOCATION, MAGNIFICATION OF GRAPH, GRID SPACING AND DASHING, ETC.).
- SHOW : TO DISPLAY THE CURRENT VALUES OF SUCH CALCOMP (VERSATEK) PARAMETERS.
- ONCE THE NEW DT/INCH IS SENT (OR BLANK, TO LEAVE THIS SCALING UNALTERED), THE CALCOMP (VERSATEK) PLOT WILL AUTOMATICALLY BE PRODUCED. WHEN DONE, THE INNER-LEVEL DIALOGUE RESUMES.
- FACTOR -- TO INPUT A NEW VECTOR OF PLOT-VARIABLE MULTIPLICATIVE SCALING FACTORS ($\$A\$$ OF $Z = AX + B$). ZERO IS TAKEN TO MEAN UNITY, AND FREE FORMAT IS USED.
- OFFSET -- LIKE $\$FACTOR\$$, ONLY FOR A VECTOR OF CONSTANTS $\$B\$$.
- RESCALE-- TO RETURN TO NATURAL SCALING (I.E., $A=1.0$, $B=0.0$) FOR ALL VARIABLES. THIS IS ONLY OF USE IF $\$FACTOR\$$ OR $\$OFFSET\$$ HAVE PREVIOUSLY BEEN USED.
- LIMITS -- TO INPUT REVISED MINIMUM AND MAXIMUM VALUES FOR THE VERTICAL AXIS OF THE PLOT.
- AVERAGE-- TO ADJUST THE OSCILLATION LIMIT AFTER WHICH AVERAGING OF SUCCESSIVE ORDINATES OF A CURVE IS TO BE INSTITUTED.
- TIME -- TO INPUT TIME-AXIS LIMITS TMIN AND TMAX OF THE PLOT. THIS MUST BE DONE AT LEAST ONCE, FOR THE FIRST PLOT, UNLESS $\$TIMESPAN\$$ WAS PREVIOUSLY USED DURING MIDDLE-LEVEL DIALOGUE.
- ALL TIME--REQUEST FOR A PLOT OVER THE FULL RANGE OF THE DATA. THIS ONLY WORKS IF $\$TIMESPAN\$$ WAS PREVIOUSLY USED DURING MIDDLE-LEVEL DIALOGUE.
- BLANK -- A BLANK IS INTERPRETED AS A REQUEST FOR A PLOT USING THE SAME TIME AXIS AS THE PRECEDING PLOT (OR THE FULL TIME RANGE, IF THIS IS THE FIRST PLOT, BUT $\$TIMESPAN\$$ WAS PREVIOUSLY CALLED).
- CURSOR -- TO TOGGLE THE SWITCH WHICH INDICATES WHETHER OR NOT CURSOR INPUT IS EXPECTED AFTER A TEKTRONIX PLOT IS DRAWN. IN THIS MODE, OTHER KEY WORDS APPLY :
- P ----- TO MARK ANOTHER CURSOR POINT
- E ----- TO TERMINATE SUCH INPUT.
- SHOW --- TO PRODUCE A TABULATION OF ALL CURSOR POINTS
- SLOPE --- TO PRODUCE DX, DY, F, AND DY/DX OF ANY POINTS. AFTER LAST M & K VALUES HAVE BEEN SENT, SEND 0, 0 TO TERMINATE.
- END ---- TO TERMINATE ALL CURSOR DISPLAYS, AND RETURN TO INNER-LEVEL DIALOGUE.
- X-Y PLOT--TO TOGGLE THE SWITCH WHICH CHOOSES BETWEEN REGULAR TIME PLOTS AND X-Y PLOTS.

Further comment about some of the just-listed commands is appropriate:

PIEP-10

- STACK ---- This OUTER level response is not presently being honored. Should the user desire a list of all available plot-file names, he can use the VAX/VMS DCL statement
\$ DIR * *.PL4;*
- If the user is logged in to his own area, and is interested only in his own plot files, then the square brackets and enclosed asterisk are omitted (this is a wild card for the search of all directories, recall).
- LONGER ---- This OUTER level response refers only to a buffer which accumulates CalComp plots; it belongs not to TPLOT, but rather to the CalComp interface software of our Versatek. The axis length of any one plot, including that displayed on the terminal, is another question entirely.
- IN ----- A user is free to change levels at will, by means of these
OUT commands. I know of no complications or restrictions at this time.
- TIME UNITS - This MIDDLE level response merely selects the time units which the user chooses to specify Tmin and Tmax in. TPLOT then converts all times to seconds, and uses seconds for output purposes without exception. If "TIMESPAN" is used, units are automatically set to "3" (seconds), though a user can subsequently over-ride this using "TIME UNITS" .
- BACK ---- Sometimes a user mistypes a MIDDLE level key word, which then is misinterpreted by TPLOT to be a garbage string ("X"). As a result, TPLOT begins asking for node-voltage variables. The "BACK" command was designed to immediately rectify such a mistake by returning to MIDDLE level dialogue (where the user gets a second chance to spell his key word).
- MESSAGE --- This INNER level response is used in conjunction with other line printer output. Note that "EXTREMA" and "LEVEL" allow for a copy to appear on the line printer. But how will the user identify such output after his plotting session is over, if he has made numerous plots? Use of "MESSAGE" allows the user to append explanatory notes at will.
- EXTREMA --- This INNER level response allows the user to determine exact minima and maxima of his graphs, along with times of their occurrence. Note carefully the pause which follows this output --- designed to allow the user to make a copy or erase the screen before the plot begins. See further explanation and example in Section F .
- SMOOTH --- The associated tolerance is the square of the maximum error in inches which will be tolerated. Relative extrema are never discarded, so peak values and the times of their occurrence are unaffected by such usage. If the user wants to plot all points (i.e., discard none), then he need only input a value of zero. Plotting is typically much slower then, however. It has been found that typically about 80% of the data points can be discarded, with negligible degradation of visible quality.

FACTOR
OFFSET

FACTOR ---- Any user who mixes plot-variable types (e.g., node voltages and branch currents) will have a need for scaling one or more curves. Remember, readings in amps and volts are usually quite different in size. Should such scaling be performed at user request, it will be documented on the plot.

LIMITS ---- If the user wants to choose his own vertical-axis scaling, he uses this **INNER** level request. **TPPLOT** will subsequently ask him for a vertical axis minimum and maximum. Particularly in cases where automatic axis scaling has allowed a curve to overshoot the grid a little (see preceding Tektronix example), this may be desirable.

X-Y PLOT -- It is possible to plot one **EMTP** variable against another, rather than against time. There are several restrictions and cautions, as explained in Section I on page 25 .

D. Using the Tektronix 4014 Cursor (key word "CURSOR")

Not infrequently, users who are studying plots end up estimating times, ordinates of key features, time differences, frequencies, rise rates, and the like. Using a ruler, this is usually time consuming and inaccurate at best. But the Tektronix 4014 has a crosshair cursor which solves this problem. For use with **TPPLOT**, it is actuated by means of the "CURSOR" request at the **INNER** level, as shall now be described.

If the cursor is to be used, it must be requested before a Tek 4014 plot is produced. Execution of **TPPLOT** begins with the cursor turned off (unless this state is altered by "SET DATA"). The key word is "CURSOR" --- either to turn the cursor off (if now on) or on (if now off). This is an **INNER** level request. For example:

```

ASSIGN TPPARAM.DAT FOR030
$ RUN TPPLOT
?? OUTER :SET DATA
SEND SUBSET NUMBER :1
?? OUTER :M/DD HH.MM.SS
CONFIRMATION : 03/16/79 13.47.56
?? MIDDLE :TS
DATA TIME LIMITS, IN SECONDS : 0.62832E-02 0.62832E+01
?? MIDDLE :
SEND NODE NAME OR END ( ) :NODE1
SEND NODE NAME OR END ( ) :LAST
SEND SUPER-TITLE ( ... ) :REPEAT
?? INNER :CURSOR
?? INNER :
```

At this point, the user sent a blank (carriage return), which erased the screen and produced the plot shown at the top of the next page (but without the "P1", "P2", and "P3" markings). Then, rather than display the familiar "?? INNER :" prompt, completion of the plot will be signaled by **TPPLOT** illuminating the cursor crosshairs. By means of the two thumb wheels on the keyboard, the user can position the crosshairs at whatever point on the plot may be of interest. A user then sends a "P", which **TPPLOT** will acknowledge by writing "PK"

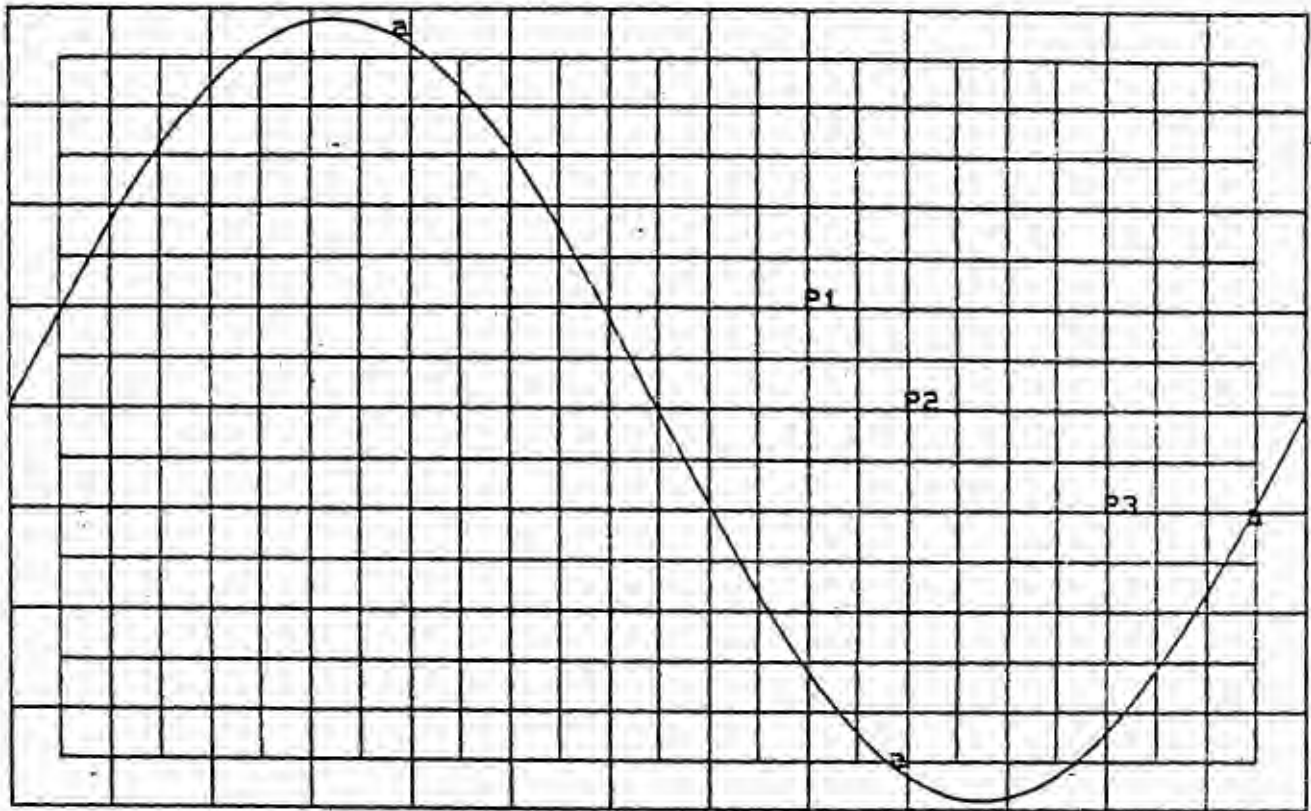

FILE : 03/16/79 13.47.56

NAMES : NODE1

YMIN, YMAX, DY/IN = -0.8000E+01 0.8000E+01 0.2000E+01
 TMIN, TMAX, DT/IN = 0.62832E-02 0.62832E+01 0.48284E+00

on the screen, where "K" is the point number (in order of input; 1 for the first point, 2 for the second, etc.). The bottom of the "P" will rest on the intersection of the crosshairs (in this example, I tried to line up the crosshairs with the grid lines). This process is repeated over and over, for as many different points as may be of interest to the user (three were used in this example, note).

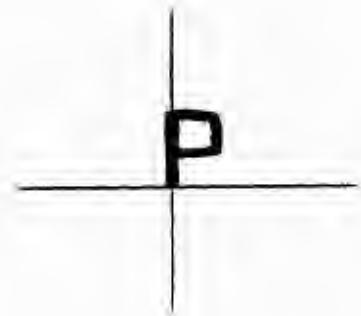

After the last point of interest, the user sends "E", and begins considering statistics related to these points. He should erase the screen before doing this, if superposition on the plot is not desired. At this point, TPLOT will prompt with "!! CURSE :", to which three responses are presently possible:

- a) "SHOW" ---- to display (t, v) coordinates of all marked points, where 't' is used to signify time and 'v' is used for the vertical-axis value (ordinate).
- b) "SLOPE" --- to calculate Δt , Δv , $\Delta v / \Delta t$, and $f = 1 / \Delta t$. This is done selectively, one pair of points at a time, in response to user request. Note that scale factors for both variables are allowed (see dialogue at top of next page), if desired. A zero value sent by the user does not alter the old value within parentheses.

These scale factors begin at unity, which was the case for this usage. If a user wanted msec rather than sec, however, he would use a DT multiplier of 1000.0 (and frequencies F would then be in kilohertz, remember). Sending "0, 0" for "M, K" terminates this computation.

- c) "END" ----- to terminate such cursor point processing, and return to INNER level dialogue. If finished with the cursor (if it is not wanted on the next plot), type "CURSOR" at this point. This will toggle it to the off position.

These points are illustrated below, where the default scale factors of unity are used, and only two pairs of points ----- (2, 1) and (3, 2) ----- are considered.

```
PROCESS 3 CURSOR POINTS :
!! CURSE :SHOW
POINT : 1 2 3
SECONDS : 0.38622E+01 0.43450E+01 0.53107E+01
VERTICAL: 0.20278E+01 0.27778E-01 -0.20000E+01
!! CURSE :SLOPE
SUPPLY MULTIPLIERS FOR DT & DU ( 1.00 1.00 ) :0 0
T(M) - T(K) U(M) - U(K) DU / DT F = 1 / DT
ENTER M, K :2 1 0.48284E+00 -0.20000E+01 -0.41422E+01 0.20711E+01
ENTER M, K :3 2 0.96568E+00 -0.20278E+01 -0.20999E+01 0.10355E+01
ENTER M, K :0 0
!! CURSE :END
?? INNER :
```

E. Customized TP PLOT Parameters for "SET DATA" Usage

As mentioned in paragraph one on page 4, the user can establish one or more data sets which customize TP PLOT according to his own specific needs. For example, if he uses TP PLOT through a Tek 4014 terminal, he certainly does not want the program set to output character plots (which is the default setting). This section shall explain how the user can define his own personal default values, to be installed via the "SET DATA" command of OUTER level dialogue.

Let us begin with an illustration the effects of which have already been shown (e.g., see page 4, and Point P2 on page 5). The following is a listing of the file named TPPARAM.DAT :

```
SET DATA 1
6, 13.
7, 1.E-35
0, 1.0, END OF FLOATING-POINT CHANGES.
9, 1
23, 120
26, 3
42, 12
46, 130
48, 760
62, 35
0, 0 END OF INTEGER-VARIABLE CHANGES.
38TS
BLANK CARD ENDS CHANGES TO KEY WORDS.
SET DATA 2
6, 13.
0, 1.0 BLANK CARD ENDS FLOATING-POINT ENTRIES.
9, 1
```

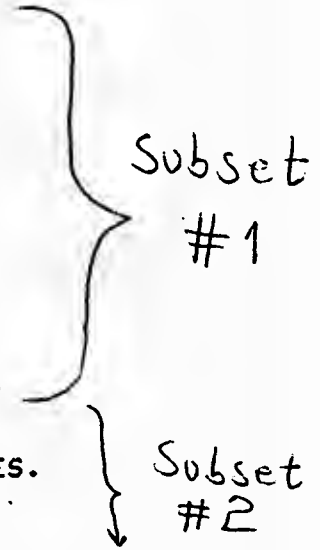

38TS
23AT
35NP
25SC
13PB

BLANK CARD ENDS KEY-WORD ENTRIES.

A number of general conclusions can be drawn from this one specific example. Consider the following:

- C1 : The record "SET DATA 1" begins the first subset, while "SET DATA 2" begins the second. These are special fixed-format markers, so be careful of blanks. Up to a maximum of 99 data subsets are allowed, with the final one being marked by the record "SET DATA99" .
- C2 : Within each data set, there are three classes of parameter definitions. First come the REAL parameters, then come the INTEGER ones, and finally come the alphanumeric key words. Each of these classes is terminated by a zero or blank record. The REAL and INTEGER data are VAX free-format, while key word cards are fixed-format (read with I2, A8 FORMAT).
- C3 : Each parameter definition consists of a pair of data. First comes an identifying index, and second comes the new parameter value. For example, consider the first parameter definition of data subset number 1 ("6, 13."). This is a command to set REAL parameter number 6 (length of the time axis, in fact) to 13 inches. A full listing of the parameters which can be so controlled will be found below.
- C4 : Arbitrary comments can be written on the right of any card, since they will never be read by TPLOT. I added such comments only to the blank or termination records, note. This provides a convenient way for the user to document what parameters are being set, or why (e.g., "Tek screen allows 13-inch time axis"). After the blank card ending key words of any data subset, and before the following SET DATA record, an arbitrary number of arbitrary records can be inserted for purposes of documentation; they will never be read by TPLOT.
- C5 : Data subsets need not be in natural order within the file, and arbitrary 2-digit integer numbers can be used, as long as they are unique. If explanatory comments at the top of the file are desired, simply begin with the record "SET DATA99" . This can then be followed by an arbitrary number of explanatory records. As long as no user requests data subset number 99 , this data will never be read by TPLOT.

As for determining which parameters of TPLOT have which identification numbers, this comes directly from EQUIVALENCE statements of the FORTRAN listing. For the three different classes of variables, we have the three associations which are shown on the following page. Note that "FVCOM" is for REALs, "FICOM" is for INTEGERS, and "AVCOM" is for A8 alphanumeric parameters. The example of Point C3 comes from the EQUIVALENCE of FVCOM(6) and TAXISL , with the latter variable being used for the time axis length in inches.

```

EQUIVALENCE ( FUCOM( 1),  UMIN ), ( FUCOM( 2),  UMAX )
EQUIVALENCE ( FUCOM( 3),  HMIN ), ( FUCOM( 4),  HMAX )
EQUIVALENCE ( FUCOM( 5),  HA ), ( FUCOM( 6),  TAXISL )
EQUIVALENCE ( FUCOM( 7),  TOLRCE ), ( FUCOM( 8),  HTAX )
EQUIVALENCE ( FUCOM( 9),  XTIT ), ( FUCOM(10),  YTIT )
EQUIVALENCE ( FUCOM(11),  SIZTIT ), ( FUCOM(12),  XSUPER )
EQUIVALENCE ( FUCOM(13),  YSUPER ), ( FUCOM(14),  SIZESUP )
EQUIVALENCE ( FUCOM(15),  FLINE ), ( FUCOM(16),  SIZID )
EQUIVALENCE ( FUCOM(17),  XID ), ( FUCOM(18),  YID )
EQUIVALENCE ( FUCOM(19),  FACT ), ( FUCOM(20),  DXGRD1 )
EQUIVALENCE ( FUCOM(21),  DYGRD1 ), ( FUCOM(22),  DXGRD2 )
EQUIVALENCE ( FUCOM(23),  DYGRD2 ), ( FUCOM(24),  FILL1 )
EQUIVALENCE ( FUCOM(25),  FILL2 ), ( FUCOM(26),  US )
EQUIVALENCE ( FUCOM(27),  VL ), ( FUCOM(28),  VH )
EQUIVALENCE ( FUCOM(29),  PAPMAX ), ( FUCOM(30),  TIMBEG )
EQUIVALENCE ( FUCOM(31),  TIMEND ), ( FUCOM(32),  FHTAX )
EQUIVALENCE ( FUCOM(33),  FXSUP ), ( FUCOM(34),  FYSUP )
EQUIVALENCE ( FUCOM(35),  FXTIT ), ( FUCOM(36),  FYTIT )
EQUIVALENCE ( FUCOM(37),  FXID ), ( FUCOM(38),  FYID )
EQUIVALENCE ( FUCOM(39),  FTCARR ), ( FUCOM(40),  VAXISL )

```

```

EQUIVALENCE ( IUCOM( 1),  KLEVL ), ( IUCOM( 2),  KEXTR )
EQUIVALENCE ( IUCOM( 3),  IHS ), ( IUCOM( 4),  LUNIT7 )
EQUIVALENCE ( IUCOM( 5),  IPRSUP ), ( IUCOM( 6),  LIMCOL )
EQUIVALENCE ( IUCOM( 7),  LINEPR ), ( IUCOM( 8),  LUNIT6 )
EQUIVALENCE ( IUCOM( 9),  LTEK ), ( IUCOM(10),  HUMTIT )
EQUIVALENCE ( IUCOM(11),  NUMSYM ), ( IUCOM(12),  RTIT )
EQUIVALENCE ( IUCOM(13),  MAXISX ), ( IUCOM(14),  MAXISY )
EQUIVALENCE ( IUCOM(15),  MGRID1 ), ( IUCOM(16),  MGRID2 )
EQUIVALENCE ( IUCOM(17),  MSUPER ), ( IUCOM(18),  MID )
EQUIVALENCE ( IUCOM(19),  MLINE ), ( IUCOM(20),  NCUT1 )
EQUIVALENCE ( IUCOM(21),  NCUT2 ), ( IUCOM(22),  NSMTH )
EQUIVALENCE ( IUCOM(23),  IBAUD ), ( IUCOM(24),  NXMAX )
EQUIVALENCE ( IUCOM(25),  NYMAX ), ( IUCOM(26),  LCHID )
EQUIVALENCE ( IUCOM(27),  NXINCH ), ( IUCOM(28),  NYINCH )
EQUIVALENCE ( IUCOM(29),  NXOFF ), ( IUCOM(30),  NYOFF )
EQUIVALENCE ( IUCOM(31),  LOOK ), ( IUCOM(32),  LCHSUP )
EQUIVALENCE ( IUCOM(33),  LCHTIT ), ( IUCOM(34),  LCHXAX )
EQUIVALENCE ( IUCOM(35),  LCHYAX ), ( IUCOM(36),  ITERM )
EQUIVALENCE ( IUCOM(37),  LTIC ), ( IUCOM(38),  IZTIT )
EQUIVALENCE ( IUCOM(39),  IZGR1 ), ( IUCOM(40),  IZGR2 )
EQUIVALENCE ( IUCOM(41),  LDShG1 ), ( IUCOM(42),  LDShG2 )
EQUIVALENCE ( IUCOM(43),  IZXAX ), ( IUCOM(44),  IZYAX )
EQUIVALENCE ( IUCOM(45),  NXIDG ), ( IUCOM(46),  NYIDG )
EQUIVALENCE ( IUCOM(47),  NXEND ), ( IUCOM(48),  NYEND )
EQUIVALENCE ( IUCOM(49),  IZID ), ( IUCOM(50),  JSMSEG )
EQUIVALENCE ( IUCOM(51),  ICHREF ), ( IUCOM(52),  ICHEND )
DIMENSION MSYMBT(20)
EQUIVALENCE ( IUCOM(61),  MSYMBT(1) )

```

C NOTE THAT PRECEDING EQUIVALENCE OCCUPIES CELLS 61, 62, .. 80.

```

EQUIVALENCE ( AUCOM( 1),  CHOICE ), ( AUCOM( 2),  STOP )
EQUIVALENCE ( AUCOM( 3),  PURGE ), ( AUCOM( 4),  OUT )
EQUIVALENCE ( AUCOM( 5),  HELP ), ( AUCOM( 6),  SMOOTH )
EQUIVALENCE ( AUCOM( 7),  SIZE ), ( AUCOM( 8),  SHOW )
EQUIVALENCE ( AUCOM( 9),  LINEZZ ), ( AUCOM(10),  COPY )
EQUIVALENCE ( AUCOM(11),  REPEAT ), ( AUCOM(12),  FLUSH )
EQUIVALENCE ( AUCOM(13),  PLAYBA ), ( AUCOM(14),  PEN )
EQUIVALENCE ( AUCOM(15),  MULTIP ), ( AUCOM(16),  OFFSET )
EQUIVALENCE ( AUCOM(17),  LIMITS ), ( AUCOM(18),  DEBUG )
EQUIVALENCE ( AUCOM(19),  TEK ), ( AUCOM(20),  STACK )
EQUIVALENCE ( AUCOM(21),  PRINTE ), ( AUCOM(22),  METRIC )
EQUIVALENCE ( AUCOM(23),  ALLTIM ), ( AUCOM(24),  COLUMN )
EQUIVALENCE ( AUCOM(25),  SETCOL ), ( AUCOM(26),  LONGER )
EQUIVALENCE ( AUCOM(27),  AVERAG ), ( AUCOM(28),  INNER )
EQUIVALENCE ( AUCOM(29),  RESCAL ), ( AUCOM(30),  LAST )
EQUIVALENCE ( AUCOM(31),  BATCH ), ( AUCOM(32),  PUNCH )
EQUIVALENCE ( AUCOM(31),  BATCH ), ( AUCOM(32),  PUNCH )
EQUIVALENCE ( AUCOM(33),  EXTREM ), ( AUCOM(34),  LEVEL )
EQUIVALENCE ( AUCOM(35),  NOPLOT ), ( AUCOM(36),  MESSAG )
EQUIVALENCE ( AUCOM(37),  END ), ( AUCOM(38),  TIMESP )
EQUIVALENCE ( AUCOM(39),  LABEL ), ( AUCOM(40),  TIMEUN )
EQUIVALENCE ( AUCOM(41),  CURSOR ), ( AUCOM(42),  XYPLOT )
EQUIVALENCE ( AUCOM(43),  SLOPE ), ( AUCOM(44),  BACK )

```

The one remaining piece of necessary information is a knowledge of the purpose of these parameters within TPPILOT. While not a complete tabulation, I here list the most important usages:

REAL variable meanings

- 6, TAXISL --- Length of the time axis, in inches, for all plots except CalComp (where the user has the option of axis length change at the instant the plot is ordered).
- 7, TOLRCE --- Square of the distance in inches of the maximum error which will be tolerated as data points are discarded (see "SMOOTH" feature).
- 8, HTAX ---- Height of the time axis on CalComp plots, in inches. The zero level is where the vertical axis begins.
- 9, XTIT ---- X and Y coordinates in inches where the first line of the
10, YTIT 80-column multi-line case title begins on a CalComp plot.
- 11, SIZTIT --- Height of the lettering which will be used for the 80-column case title text, in inches.
- 12, XSUPER
13, YSUPER -- Like 9-11, only for the one-line super-title.
14, SIZESUP
- 15, FLINE --- For CalComp plots, this is the factor which determines inter-line spacing of multi-line text outputs. This factor is multiplied by the letter height in order to get the vertical distance per line. A value of 1.7 would give 70% of the letter height as blank space between the lines, then.
- 17, XID
18, YID -- Like 9-11, only for the date, time, variable names, etc.
16, SIZID
- 19, FACT ---- Blow-up (expansion) factor of CalComp plotting. The common case where this is other than unity is for metric plotting. Using a value of .7874 gives a plot where the usual one-inch spacing is shrunk to 2.0 cm.
- 20, DXGRD1 ---- Spacing in inches between major (number 1) grid lines of
21, DYGRD1 CalComp plots. The DX is separation between vertical (constant-time) grid lines, etc.
- 22, DXGRD2 --- Repeat, only for minor (number 2) grid lines.
23, DYGRD2
- 24, FILL1 ---- Fill-in factors for grid lines of CalComp plots. The 1
25, FILL2 applies to the major grid, and 2 to the minor grid. Use a value of 1.0 for solid lines, and 0.25 for a dashed grid line which is three fourths invisible. See integer parameters 20 and 21, too.
- 26, VS ----- Parameters controlling the vertical dimension of CalComp plots.
27, VL These usages are right out of the EMTP 5 years ago, as originally set up by John Walker. The 8-inch vertical axis and one inch
28, VH lower margin come from these parameters.

- 32, FHTAX --- Location of time axis on a Tektronix plot, as a fraction of the vertical distance. Use a value of 0.5 for the middle, or zero for the bottom.
- 33, FXSUP --- Fractional horizontal position (to the right) and vertical position (up from the bottom) for the super-title of a Tektronix plot.
- 34, FYSUP
- 35, FXTIT --- Repeat, only for 80-column, multi-line case title. Here the coordinates apply to the first character of the first line.
- 36, FYTIT
- 37, FXID --- Repeat, only for the date, time, etc.
- 38, FYID
- 39, FTCARR --- Expansion factor for interline Tektronix text spacing. Use 1.0 for normal spacing, and a greater value for more blank space between lines (2.0 gives lines which are centered twice as far apart).
- 40, VAXISL --- Height of Tektronix vertical axis or vertical grid lines, in inches. For Tek 4014, 8.0 is standard.

INTEGER variable meanings

- 1, KLEVL --- Binary flag indicating whether level triggers are to be used or not. Set this flag to zero for no such triggers, or to unity if they are desired.
- 2, KEXTR --- Binary flag indicating whether minima and maxima are to be calculated or not. Zero will give no such extrema, while unity will produce it.
- 3, IHS ----- Type code for the time units ("4" means msec , etc.).
- 4, LUNIT7 --- Logical unit number for the card-punch file (used for "BATCH" request, recall).
- 5, IPRSUP --- Variable which controls diagnostic printout. As with EMTP variable of the same name, zero gives no diagnostic, etc. The value 34 is reserved for printing every time point of curve.
- 6, LIMCOL --- The number of columns used for a character (printer) plot. This is usually one less than the maximum column width of device (either 79 or 131).
- 7, LINEPR --- Logical unit number for the line printer (for use with "LINE" and "MESSAGE" requests, recall).
- 9, LTEK ----- Binary flag indicating whether character plots or Tektronix vector-graphic plots are to be produced. Use zero for character plotting, unity for Tektronix plotting.
- 11, NUMSYM --- Number of identifying symbol markings which shall be placed beside each curve.

- 12, MMIT For CalComp (Versatek) plotting,
- 13, MAXISX these are integers which characterize
- 14, MAXISY the pen width which is used for
- 15, MGRID1 various plot structures. In order,
- 16, MGRID2 we have the 80-column case title, then the X-axis
- 17, MSUPER structure, then the Y-axis structure, then the major
- 18, MLD grid, then the minor grid, then the one-line super-title,
- 19, MLINE then the plot ID (date, time, etc.), and finally the curves
- themselves. Values of -1 will turn off all such output;
- values of 1 to 5 for Versatek give the pen widths in dots.

- 20, NCUT1 --- Number of segments making up the major (#1) and the minor (#2)
- 21, NCUT2 grid lines of a CalComp plot. Use unity for a solid grid
- line. As the number of segments increases, the plotting
- speed decreases substantially!

- 22, NSMTH --- Oscillation limit (number of consecutive ups and downs) after
- which averaging of successive ordinates is instituted. This
- is used to remove spurious, nonphysical oscillations (see
- the EMTF User's Manual, Nov. 1977, page 28b).

- 23, IBAUD --- Speed at which Tektronix terminal is being driven, in number
- of characters per second. This is 960 for 9600 baud, as
- used at BPA.

- 24, NXMAX --- Limiting dot numbers for the horizontal (X) and the
- 25, NYMAX vertical (Y) directions of the Tektronix screen. For
- the standard 4014 terminal as used at BPA, a value of 1023
- is used for both of these.

- 27, NXINCH --- Number of dots per inch along the two axes of the Tektronix
- 28, NYINCH screen. For the standard 4014 as used at BPA, values of
- 71 and 72 are used, respectively.

- 29, NXOFF --- Tektronix horizontal and vertical offset, as measured in screen
- 30, NYOFF dots, from the lower left corner of the screen to that same
- corner of the major grid (if any). This defines the left
- and lower margins, then. At BPA we use 71 and 72 for
- these, representing one inch in each direction.

- 31, LOOK ---- Logical unit number for diagnostic writes within the
- Tektronix plotting module. If the Tek screen is desired
- for this diagnostic, use unit number 6 .

- 26, LCHID Codes for the character sizes that are used for labeling the
- 32, LCHSUP five different Tektronix plot data structures. In order,
- 33, LCHTIT these structures are the plot ID (date, time, etc.), the
- 34, LCHKAX one-line super-title, the 80-column multi-line case title,
- 35, LCHYAX the X-axis, and the Y-axis. A value of "1" gives the
- biggest characters (74 char/line), "2" is next (81 char/line),
- then comes "3" (121 char/line), and finally "4" (133 char/
- line). See PLOT 10 TCS User Manual page 5-3 where
- SUBROUTINE CHRSTZ is explained.

- 37, LTIC ---- For tic marks on Tektronix X and Y axes (drawn every
- inch), this is the length of the mark, as measured in
- number of screen dots.

- 36, ITERM --- First argument of CALL TERM , which specifies the
- terminal model to Tektronix TCS. See the PLOT 10 TCS
- User manual, page 5-1 .

- 38, IZTIT Arguments of calls to Tektronix
 39, IZGR1 PLOT 10 subroutine "CZAXIS",
 40, IZGR2 which controls (in a very minor
 43, IZXAX way) the boldness of the light
 44, IZYAX beam. A value of zero is for normal
 49, IZID weight, while a value of unity defocuses the beam ("broader and slightly brighter"). In order, these parameters apply to the plot data structures which follow: 80-column multi-line case title, the major grid, the minor grid, the X-axis structure, the Y-axis structure, and the plot ID (date, time, etc.).
- 41, LDSHG1 --- Tektronix PLOT 10 parameters associated with major and
 42, LDSHG2 minor grids, used as the third argument of CALL DSHABS which draws the straight lines which make up the grids. If set to zero, a solid grid results (which is fastest). If set to 12, the grid lines will be dashed, with alternating five dots of bright and five dots of dark. If set to 34, there will be alternatively ten dots of light and dark. Various other combinations are possible (see page 3-13 of PLOT 10 TCS User Manual).
- 45, NXID6 --- Tektronix screen dot coordinates for the location where the
 46, NYID6 plot ID (date, time, etc.) will begin. This locates the lower left corner of the top line.
- 47, NXEND --- Tektronix screen dot coordinates for the location where
 48, NYEND the beam will be positioned when the plot is completed, and the user continues with INNER level dialogue.
- 51, ICHREF. --- ASCII character codes for the key stroke that is used to mark a cursor location, and to end such cursor input, for Tektronix plots. For "P" and "E" as used here at BPA, values 80 and 69 are used, respectively.
- 61, MSYMBT --- Beginning with cell 61, a vector of ASCII character codes is used to select the symbols used to mark the up to 20 curves which can be plotted simultaneously. The default usage is to employ lower case letters (the first curve using "a" is from 61, 97; the second curve using "b" is from 62, 98; etc.).

F. Built-in Statistics of Plots using "EXTREMA" and "LEVEL"

The "EXTREMA" and "LEVEL" features were briefly described near the bottom of page 8. Because they are of universal interest, they are more fully described here.

As an example, consider the TPLOT dialogue of page 4, only with "EXTREMA" and "LEVEL" requests sent before the carriage return which actually produced the plot. The final line on page 4 then is to be replaced by the dialogue shown at the right. Note that TPLOT responded to the "LEVEL" input with a request for a vector of levels for the variables being plotted. The three zeroes were the old values then in force (zero because they had never been defined). The user then

```
?? INNER :EXTREMA
?? INNER :LEVEL
INPUT VECTOR OF LEVELS :
0.00E+00 0.00E+00 0.00E+00
5.0 -10. 5.0
?? INNER :
```

submitted values 5.0 , -10.0 , and 5.0 .

This is an illustration of the VAX free-format usage, where one blank character has been used for field separation. Since the equations of the curves are $7.8 * \sin(t)$, $12.5 * \cos(t)$, and t , respectively, the user can verify the following extrema and level crossings which result from sending a carriage return:

M PLOT	NAME-1	NAME-2	MINIMUM	MAXIMUM	T OF MIN	T OF MAX
2	NODE1		-0.78000E+01	0.78000E+01	0.47124E+01	0.15708E+01
1	NODE2		-0.12500E+02	0.12500E+02	0.31416E+01	0.62832E-02
3	NODE1	NODE2	0.62832E-02	0.62706E+01	0.62832E-02	0.62706E+01
LEVELS SOUGHT :			0.5000E+01	-0.1000E+02	0.5000E+01	
1ST HIT TIME :			0.695837E+00	0.249810E+01	0.500000E+01	

There will be a pause after this output; the associated plot will not follow without additional user input. This allows the user time to study the above display, perhaps push the Tektronix hard copy button, or erase the screen. There are three possible user responses to this pause (which involves no visible prompt):

- a) If the user sends a carriage return, the associated plot will be produced. When the plot is completed, there will be a return to INNER level dialogue.
- b) If the user sends "LINE" , a copy of the just-displayed extrema and/or level crossings will be sent to the line printer file (logical unit number 9 , unless redefined using "7, LINEPR" of page 17 or "PRINTER" of page 7). When this dispatch is complete (it will take as long as the visible one), this status will be noted on the terminal. The user must then choose once again among these three available responses to the pause.
- c) If the user sends "NO PLOT" , there shall be an immediate transfer to INNER level dialogue. This is like option "a" , except with the plot omitted (and with no time delay).

So that the user does not forget particular circumstances of this line printer dispatch, he may want to also send some explanatory or documentary text to the line printer at this point, using the "MESSAGE" feature of INNER level dialogue. See pages 8 and 10 .

Note that the "EXTREMA" display provides an automatic way of documenting which EMTP variables have been plotted. Whereas just the plot alone may involve ambiguity (see Point P11 on page 6) , not so for the "EXTREMA" tabulation. Note that a pair of names is provided for each curve (with the second being blank for node voltages, which only involve one aname), along with an index M PLOT . The absolute value of M PLOT is the position in the EMTP output vector, for the simulation which produced this plot file. For example, the first row is for node voltage NODE1 , which is the second output quantity of the plot data file. If the EMTP solution printout is not available, the "CHOICE" display of MIDDLE level dialogue could also provide a listing of available outputs, in order.

A warning about the range of both the "EXTREMA" and the "LEVEL" computations : they apply to data points after insignificant ones have been discarded, and usually the last such point (for greatest time) is not included. As for the estimation of level crossings, simple linear interpolation is used.

G. An Example of Character Plotting

PIEP-21

```

SUPER-TITLE : SUPER TITLE TEXT!
VERTICAL AXIS : VERTICAL AXIS.
GRAPH MINIMUM (COL. 1) = -0.100000E+02
GRAPH MAXIMUM (LAST COL) = 0.100000E+02
GRAPH SCALING (CHANGE PER ONE INCH = 10 COLS.) = 0.253165E+01
SIMULATION IDENTIFICATION = 03/16/79 13.47.56
LIMITS ON TIME = 0.62832E-02 AND 0.62832E+01 SECONDS
PLOT TYPE-NUMBER = 9
VARIABLE NAMES (4A8 FORMAT) = NODE1 NODE2 NODE1 NODE2
    
```

```

GRAPH TITLE : FIRST LINE OF CASE TITLE TEXT.
GRAPH TITLE : SECOND LINE OF SUCH TEXT.
    
```

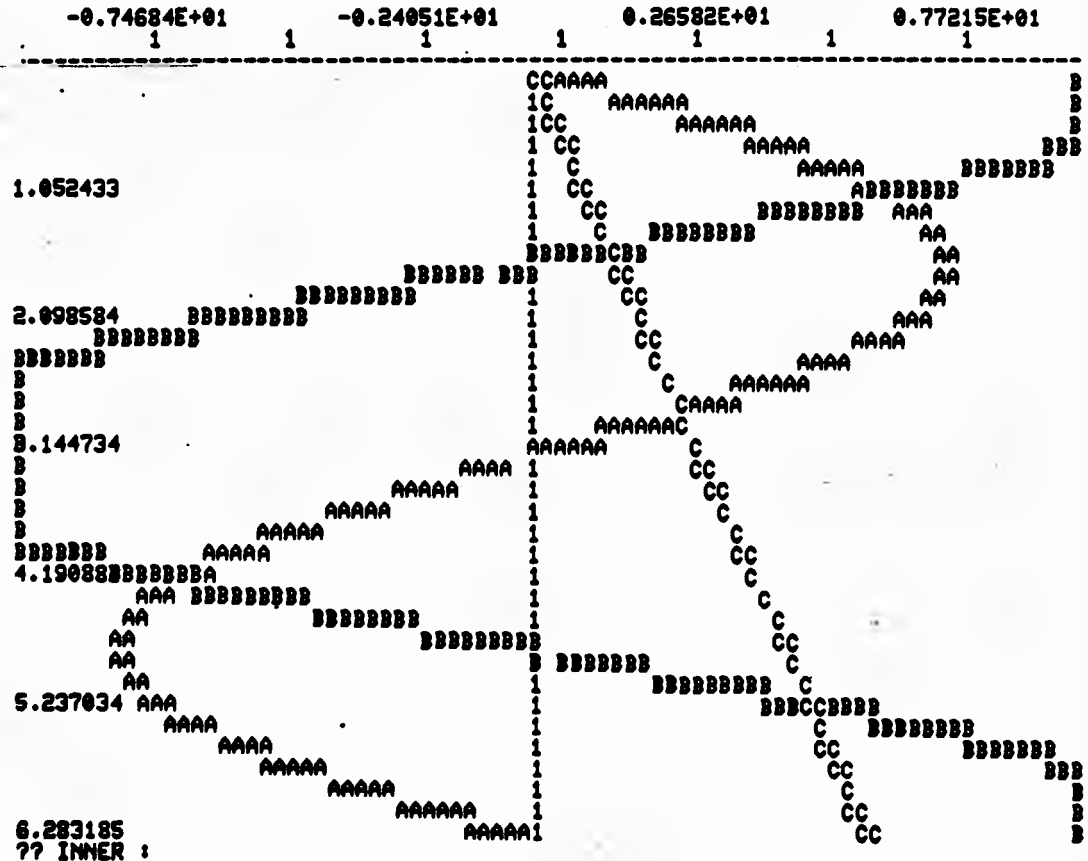

If one does not have access to a Tektronix vector-graphic terminal, he can still get graphs from TPLOT in the character mode. An 80-column version of the Tektronix plot on page 6 is displayed above. Several observations about this output might be useful:

- OB-1 : Resolution along the time axis (which runs down the screen of a CRT) may be critical, if there are fast transients or high frequencies. The length of the time axis can be set at will (see "SIZE" at the top of page 9, or "6, TAXISL" on page 16). The display shown here used the default length of six inches.
- OB-2 : Unlike EMMP batch-mode printer plots, there is no common symbol "*" for locations where two or more curves cross. Instead, it is the symbol for the last curve making the crossing which is used.
- OB-3 : The "LINE" command of INNER level dialogue will dispatch a character plot to the line printer file (logical unit number 9). If the user is working at a CRT, this provides sort of a poor-man's hard copy unit. When such a copy operation is complete, that fact will be noted on the computer terminal, and INNER level dialogue can resume.

- OB-4 : Typewriter terminals like our own DECwriter are maddeningly slow for usage with TPLOT. At 30 char./sec, it takes a minute or two to produce a six-inch plot. The 80-column plots are of course substantially faster than the 132-column plots, in proportion to the reduced width. Character plotting really was not designed for typewriter terminals, but rather for CRTs which are being driven fast (at BPA, we use 960 characters/sec for all CRTs).
- OB-5 : If a Tektronix terminal is available, the use of character plots on it are to be discouraged. The vector graphic mode is not only much more accurate, but also faster (unless the user gets bogged down with intricate dotted background grids and/or a very large number of plotted points).
- OB-6 : Unlike for Tektronix or CalComp plots, the graph limits of a character plot are strictly enforced. Note that curve "B" has been clipped, for this reason. To avoid this, the user need only expand the minimum and maximum slightly, using the "LIMITS" request of INNER level dialogue. This is a slightly annoying aspect to the automatic scaling logic : it rounds to the the nearest nice numbers (so that in some cases, a curve may be slightly chopped).

H. CalComp Plotting via the "COPY" Command

Recall that the "COPY" command of INNER level dialogue was introduced near the top of page 9 . As set up here at BPA using our 11-inch Versatek printer/plotter with all default "PEN" and "SIZE" settings, a plot analogous to that of the Tektronix display on page 6 then appears as at the top of the following page. Much of the user-TPLOT dialogue associated with this plot is shown one page further. . Because character plots are not the subject of interest here, that display was cut out in order to save space. Also, I used the "SHOW" feature to document the pen widths, text coordinates and sizes, and grids of the plot. After that, the CalComp plot was initiated by sending the new time-axis scaling of 0.8 sec/inch (compared with 1.05 which was in force for the character plot, based on a six-inch time axis). As the different structures of the CalComp plot are being produced, six lines of printout appear, to reassure the user that progress is really being made. The operation is complete when TPLOT prompts for more INNER level dialogue. More plots could be made at this point, but I chose exit TPLOT with the "STOP" command. The "FORTRAN STOP" line comes from VAX/VMS . The remaining five lines are explained two paragraphs below.

This CalComp (Versatek) plotting differs somewhat from the batch-mode plotting of the EMTP. Here plots can not be stacked vertically, and they are of fixed height (with an eight-inch vertical axis) at present.

The VAX-Versatek interface for CalComp plotting does not allow plots to come out of the Versatek immediately. Rather, such dispatches accumulate in a file. Then, when the user exits TPLOT by sending "STOP" at any level, he must do as many as four things:

- T1. First, send "\$ STOPQ" , which grabs onto the Versatek (actually, it just disables the normal status as a queued device).

SUPER-TITLE TEXT

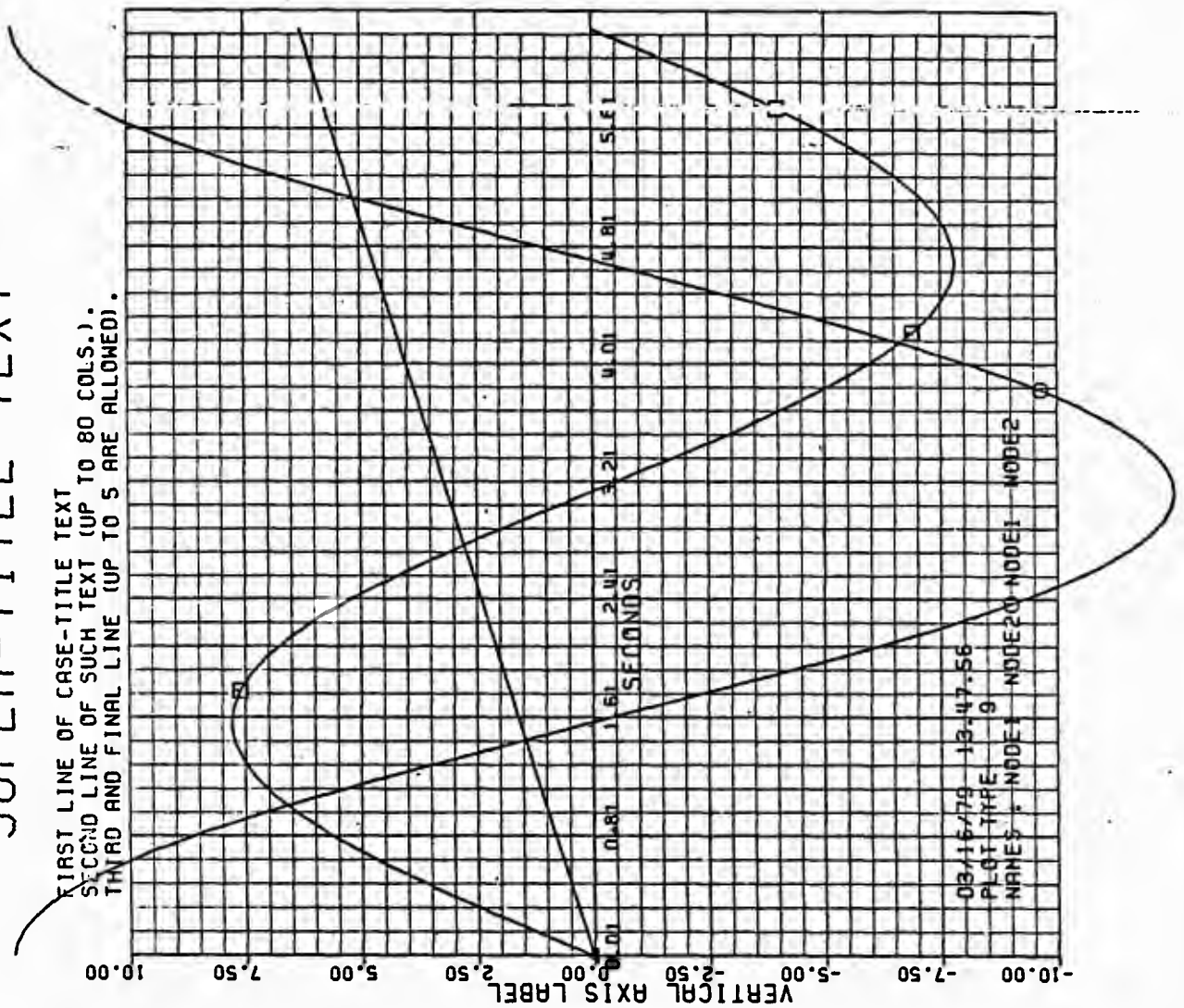

- T2. Then send "\$ MCR PHASE2" , to actually produce the plot or plots. The Versatek paper should start moving almost immediately.
- T3. When the plotting is complete, the message "*** END PHASE 2 ***" will appear. Then, unless a second copy of the plots is desired, all PLV files should be deleted by means of the command "\$ DELETE *.PLV;*" . Now that we are using PL4 for plot data file types, be careful not to confuse "V" for "4" ; these are quite separate, distinct files.
- T4. Finally, assuming that others may want to use the Versatek as a line printer, undo the Step T1 by sending "\$ GOQ" .

As with Tektronix plots, dashed background grids are expensive (time consuming) ----- both of central processor time within TPLOT, and also of real plotting (rasterization) time during the "\$ MCR PHASE2" step. Beware of this (usage of "20, NCUT1" and "21, NCUT2" on page 18 ; default settings have these two variables set to unity, as shown by the "SHOW" display on the following page). All plot text (case title, etc.) is likewise time consuming, we have found. Should the discarding of insignificant raw plot data points be disabled (see "7, TOLRCE" on page 16 , or the INNER level

```

?? OUTER :M/DD HH.MM.SS
CONFIRMATION : 03/16/79 13.47.56
?? MIDDLE :TIMESPAN
DATA TIME LIMITS, IN SECONDS : 0.62832E-02 0.62832E+01
?? MIDDLE :
SEND NODE NAME OR END ( ) :NODE1
SEND NODE NAME OR END ( ) :NODE2
SEND NODE NAME OR END ( ) :END
SEND BRANCH VOLTAGE NAMES OR END ( , ) :NODE1 NODE2
SEND BRANCH VOLTAGE NAMES OR END ( , ) :LAST
SEND SUPER-TITLE ( ... ) :SUPER-TITLE TEXT
SEND VERTICAL AXIS LABEL ( ... ) :VERTICAL AXIS LABEL
SEND CASE-TITLE LINE 1 ( ... ) :
FIRST LINE OF CASE-TITLE TEXT
SEND CASE-TITLE LINE 2 ( ... ) :
SECOND LINE OF SUCH TEXT (UP TO 80 COLS.).
SEND CASE-TITLE LINE 3 ( ... ) :
THIRD AND FINAL LINE (UP TO 5 ARE ALLOWED).
SEND CASE-TITLE LINE 4 ( ... ) :
END

```

?? INNER :

*Character plot here was removed
so as to save space*

?? INNER :COPY

SEND T-AXIS UNITS/INCH (0.105E+01) :SHOW

BEGIN WITH #PEN# PARAMETERS :

- 3 = PEN FOR 80-COLUMN CASE TITLE LINES;
- 3 = PEN FOR X-AXIS STRUCTURE;
- 3 = PEN FOR Y-AXIS STRUCTURE;
- 2 = PEN FOR BIG BACKGROUND GRID;
- 1 = PEN FOR FINE INNER GRID;
- 5 = PEN FOR 1-LINE SUPER-TITLE;
- 3 = PEN FOR DATE, TIME, ETC.

PENS FOR DRAWING INDIVIDUAL CURVES FOLLOW
3 3 3

*We will document
default CalComp
parameters the
easy way!*

NEXT COME THE #SIZE# PARAMETERS :

X-BEGIN	Y-BEGIN	HEIGHT	
0.50	8.50	0.12	--- 80-COL. CASE TITLE (1ST LINE)
0.50	0.75	0.12	--- DATE, TIME, ETC. (TOP LINE)
1.00	9.00	0.30	--- ONE LINE SUPER-TITLE
4.000			--- HEIGHT OF TIME AXIS;
1.000000			--- GRAPH MAGNIFICATION FACTOR (.7874 FOR METRIC);
3			--- NUMBER OF SYMBOLS MARKING EACH CURVE.

MAJOR GRID

MINOR GRID

1.000	1.000	---	FILL-IN FRACTIONS (1.0 FOR SOLID GRID);
1	1	---	NUMBER OF DASHES PER GRID LINE;
1.000	0.200	---	SPACING BETWEEN VERTICAL GRID LINES;
1.000	0.200	---	SPACING BETWEEN HORIZONTAL GRID LINES;

SEND T-AXIS UNITS/INCH (0.105E+01) :0.8

Initiate plot

```

READY TO DRAW TITLES.
READY TO DRAW AXES.
READY TO CALL GRID FOR #1.
DONE WITH FIRST GRID CALL.
DONE WITH SECOND GRID CALL.
READY FOR SLOT1 ENCODE.

```

*Printout generated at different
stages of CalComp plot keep
the user informed of progress.*

?? INNER :STOP ← stop TPPLOT
FORTRAN STOP

```

$ STOPQ
$ MCR PHASE2
** End Phase 2 **
$ DELETE *.PLV;*
$ GOQ

```

request "SMOOTH" at the bottom of page 8 and page 10), plots can likewise take much longer. In summary, CalComp (Versatek) plotting time seems to be directly related to the amount of information (number of pen strokes) which makes up the plot --- just as is the case for Tektronix plotting.

PIEP-25

Numerous parameters are involved with the "PEN" and "SIZE" requests of page 9 . Because they are believed to be self-explanatory, I chose not to present an example of such dialogue. The preceding page does document the default values used for the parameters (result of "SHOW" request). I would observe that "PEN" and "SIZE" are the interactive counterpart of batch-mode alterations which can be made using "SET DATA" (see pages 13-19). Any parameter which is regularly altered is a logical candidate for "SET DATA" usage, since one request can alter a whole set of parameters. On the other hand, special cases are probably more easily handled interactively using "PEN" and "SIZE" . The same parameters are involved, in either case (so do not be confused if the descriptions sound familiar).

I. "X-Y PLOT" --- To Plot One EMTP Variable Against Another

With the advent of EMTP hysteresis modeling (see Vol. VIII EMTP memo dated 27 January 1979 , pages PROV-6 through 8), it has become necessary to plot one EMTP variable against another, using time as a hidden parameter of the locus. While the immediate application is for flux vs. current plots, other uses can be conceived. TPLOT can produce such plots, using a Tektronix terminal, as shall now be explained.

The crucial key word is "X-Y PLOT" , which is recognized at the INNER level. This is a binary switch whose position is toggled between normal and x-y plotting states whenever the request is sent: Most other necessary dialogue is either the same as before, or self-explanatory. Restrictions and special cautions are covered later.

As an example of "X-Y PLOT" usage, consider the following dialogue between a user of our Tek 4014 and TPLOT. The "SET DATA" usage has already been documented in Section E , and plot variables have all been seen before (see Section B). But because of the "X-Y PLOT" request, the result is quite different (see the bottom of the next page). Applicable comments about this

```
$ ASSIGN TPPARAM.DAT FOR030
$ RUN TPLOT
?? OUTER :SET DATA
  SEND SUBSET NUMBER :2
?? OUTER :M/DD HH.MM.SS
  CONFIRMATION : 03/16/79 13.47.56
?? MIDDLE :TS
  DATA TIME LIMITS, IN SECONDS : 0.62832E-02 0.62832E+01
?? MIDDLE :
  SEND NODE NAME OR END ( ) :NODE1
  SEND NODE NAME OR END ( ) :NODE2
  SEND NODE NAME OR END ( ) :NODE1
  SEND NODE NAME OR END ( ) :END
  SEND BRANCH VOLTAGE NAMES OR END ( , ) :NODE1 NODE2
  SEND BRANCH VOLTAGE NAMES OR END ( , ) :LAST
  SEND SUPER-TITLE ( ... ) :REPEAT
?? INNER :X-Y PLOT
  ** NOW IN X-Y MODE **
?? INNER :
      XMIN          XMAX          YMIN          YMAX
      -0.78000E+01  0.78000E+01  -0.12500E+02  0.12500E+02
  SEND AXIS LIMITS :-10. 10. -15. 15.
```

usage include the following:

PIEP-26

- AC-1. All data points of the curves are plotted, without exception, between the time limits specified by the user. None are discarded, regardless of the value of tolerance "TOLRCE" (see "7, TOLRCE" on page 16).
- AC-2. No character-mode plot is possible; a Tektronix terminal is required. There is nothing illegal about trying a character-type plot, but the graph itself will be missing (which is not very illuminating).
- AC-3. The user must specify an even number of curves, paired in the order that he wants them plotted. The first variable of each pair becomes the X-axis variable, and the second the Y-axis variable. In the example, four variables were specified, giving two curves. The first curve (marked "a") involved node voltages for nodes "NODE1" and "NODE2", while the second was a hybrid using a repeat of the first node voltage and a branch voltage. Referring to page 6 where the functions are displayed, we have:

$$\text{Curve 1 : } x = 7.8 \sin(t) \quad y = 12.5 \cos(t)$$

$$\text{Curve 2 : } x = 7.8 \sin(t) \quad y = t$$

The first locus is an ellipse (with major axis aligned with the Y-axis), while the second is merely the ever-familiar sine wave plotted with time along the vertical axis.

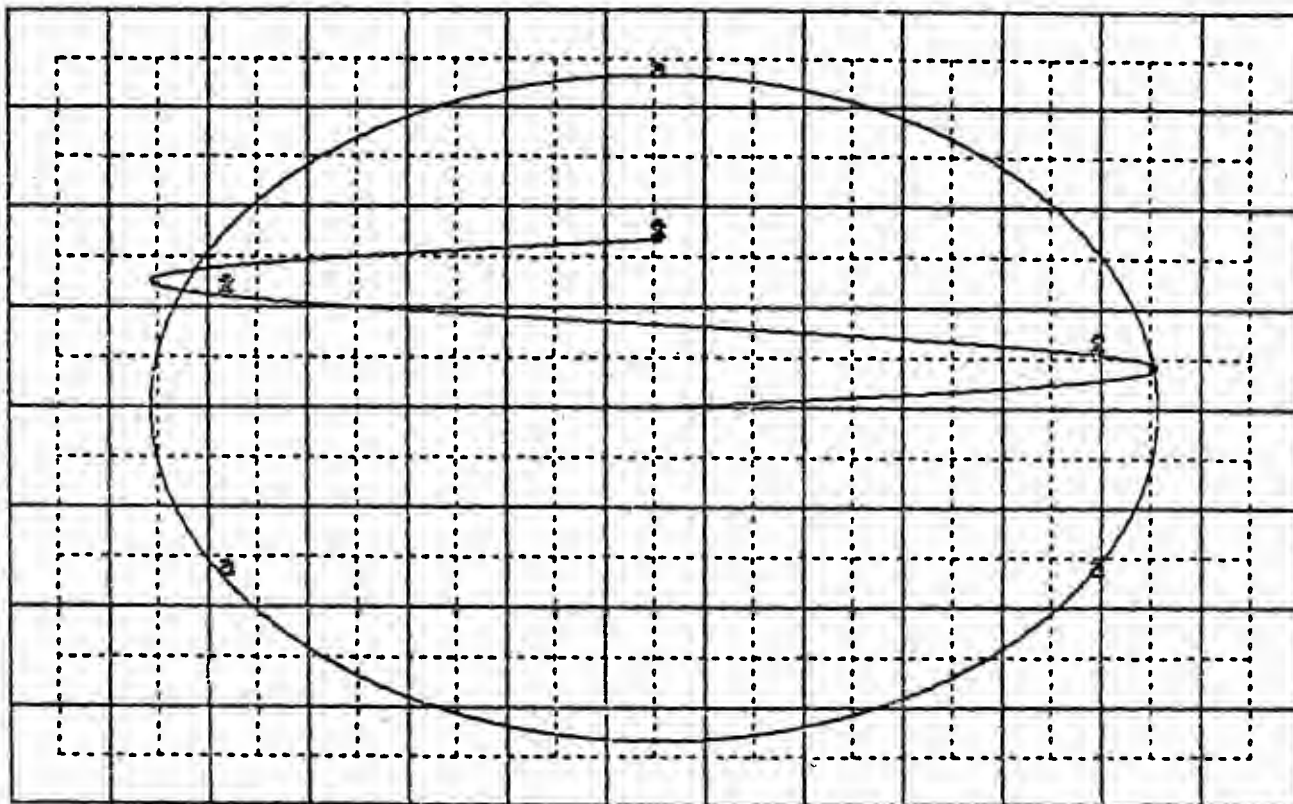

```
FILE : 03/16/79 13.47.56
NAMES : NODE1 NODE2 NODE1 NODE2
XMIN, XMAX, DX/IN = -0.1000E+02 0.1000E+02 0.1538E+01
YMIN, YMAX, DY/IN = -0.1500E+02 0.1500E+02 0.3750E+01
TRIN, TRAX, DT/IN = 0.62832E-02 0.62832E+01 0.48284E+00
?? INNER :
```

- AC-4. At least for now, a user should always re-select plot variables, for any subsequent plot. This involves use of the "OUT" request, of course, to transfer to the MIDDLE level of dialogue. This admonition holds whether another x-y plot is to follow, or whether the following plot is to be conventional. Unless this is done, there probably will be initialization problems of some sort.
- AC-5. The dialogue which immediately precedes the plot deserves some comment. Following the "X-Y PLOT" request, TPLOT reminds the user that he has exited the conventional plot mode (by sending the message "## NOW IN X-Y MODE ##"). Then the user hit the carriage return, after which TPLOT displayed maxima and minima for both axes of the curves. TPLOT further directed the user to supply four such limits for the forthcoming x-y plot. In this case, the user selected +10 for the X-axis excursion, and +15 for the Y-axis. The plot then resulted automatically, after this line of information was sent.
- AC-6. There is no indication on the plot as to which portions of the curve were produced by data points of a certain time. If this is important information, and yet is not obvious to the user, he should plot the variables of interest as a function of time. Note that this x-y plot involved the full time range of the data, though this is not necessary (if times 0.0 through 3.14 had been used, only half of the ellipse and sine wave would have been plotted).

J. Summary Explanation of TPLOT Structure

For those users who may want to adapt TPLOT for usage with another (non-Tektronix) vector-graphic CRT terminal, I have good news! Modifications are quite localized, even modularized! Read on.

Much of TPLOT is universal, and is only very superficially related to the plotting devices which might be employed. This is shown by the following explanation of general module functions:

- MAIN ----- The unnamed code in which execution begins is responsible for OUTER level dialogue (including attachment of plot files). Also, most parameters of the program are initialized in DATA statements at the beginning of this module. Such parameters are communicated among different modules via COMMON (see the INCLUDE 'TPLOTKOM/LIST' statement at the beginning of all principal modules). This main module calls "PLTVAR" .
- FLATBD ----- The CalComp plot dispatches of a "COPY" request are all produced within this module. The code is universal in that calls to CalComp subroutines are used. However, there also is some Versatek influence (e.g., characterization of the pen widths in terms of the number of dots wide).
- PLTVAR ----- This module handles all MIDDLE level dialogue. It calls module "TIMVAL" .
- TIMVAL ----- This module handles all INNER level dialogue. Once all plot parameters are known, data points are read from the plot file, and are processed. When all is ready for the actual plot, a call is made to :

TEKPLT -- for Tektronix
vector-graph
plots.

PIEP-28

LINPLT -- for character-type plots, using any type
of terminal.

In response to the key word "COPY", a call is made to
"FLATBD" for the CalComp (Versatek) copy.

LINPLT --- This module performs character-type plotting (of an arbitrary
column width, possibly for the line printer).

TEKPLT --- This module performs Tektronix vector-graphic plotting by
means of calls to PLOT 10 TCS software. Both "LINPLT" and
"TEKPLT" assume that plot data has been set up in standard
format, the most important variables of which shall now be
described. This is for conventional (not x-y) plots.

JPLT ----- Number of curves being plotted.

EW(I) ----- Vector for the storage of all data points
which are actually to be plotted. The storage
is one curve at a time, in order of input or
labeling. Each curve consists of (t, y) pairs
as consecutive entries, with time t increasing.
After the last such pair of points for any one
curve, there are the four cells reserved for
CalComp scaling information (Tmin, Ymin, dt/in,
dy/in). Vector KSTART points to such
information, as described below.

KSTART(J) -- For curve J, this is the index of EW where
the ordinate y of the last point is stored.
Immediately following are the four cells of
CalComp scaling data, and after that the beginning
of curve J+1 (if it exists).

VMIN ----- Limits for the vertical axis (y-axis).
VMAX

TAXISL ---- Length of the time axis, in inches.

HMIN ----- Limits for the time axis, in seconds.
HMAX

These are the crucial parameters. Labeling information is
quite self-explanatory (an interested reader is advised to
look at the WRITE statements at the beginning of LINPLT).
A final observation: variable "MXYPL" is zero for
conventional plots, and unity for "X-Y PLOT" cases (though
other considerations related to this latter case shall not be
documented here.

W. Scott Meyer
20 May 1979

6. TRANSFORMER REPRESENTATION USING [R] & [L] MATRICES

Type 51, 52, 53 EMTF branch components of Sect. 1.24 can be used for the representation of transformers, excluding nonlinearities.

6.1 Simplified model, with resistance neglected

The cascade connection of a generator and transformer (Fig. 1) can be represented very simply by a voltage source behind a single 3-phase reactance matrix between nodes S and A, if the following conditions are met:

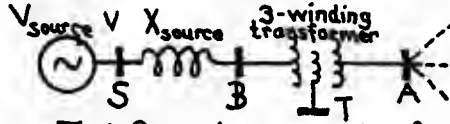

Fig. 1. Cascade connection of generator and transformer.

- 1) The voltage source is balanced,
- 2) the impedances between S and A are balanced (specifically, no switching is allowed between S and A),
- 3) in case of a three-winding transformer, the tertiary winding is either unloaded or has balanced reactances as load,
- 4) no generator currents or currents in tertiary windings are desired (only current from rest of network into A will be correct),
- 5) the frequencies in the transient phenomena are not too high (see p. 90).

Modeling Technique:

Assume the following data is given:

$$X_{\text{source}} = 4.811 \Omega \text{ (subtransient reactance)}$$

$$V_{\text{source}} = 380 \text{ kV phase-to-phase}$$

2 three-winding transformers connected in parallel, each rated 2000 MVA, with:

voltage rating on B-side: 380 kV

voltage rating on A-side: 1050 kV

tertiary connected in delta

autotransformer connection with grounded neutral

$$\left. \begin{array}{l} X_{A-B} = 12\% \\ X_{A-T} = 32\% \\ X_{B-T} = 20\% \end{array} \right\} \text{based on 2000 MVA}$$

First, transform source reactance to side A:

$$X_{\text{source-A}} = 4.811 \left(\frac{1050}{380} \right)^2 = 36.75 \Omega$$

Next, set up well-known equivalent circuit for three-winding transformer

with all values referred to side A:

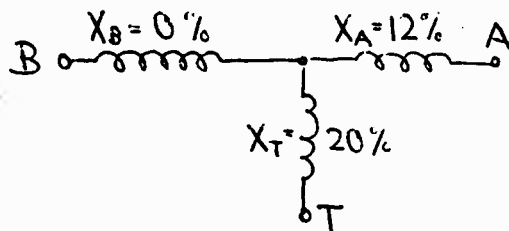

$$\left. \begin{array}{l} X_A = \frac{1}{2}(X_{A-B} + X_{A-T} - X_{B-T}) \\ X_B = \frac{1}{2}(X_{A-B} + X_{B-T} - X_{A-T}) \\ X_T = \frac{1}{2}(X_{A-T} + X_{B-T} - X_{A-B}) \end{array} \right\} \text{only correct if all } X_{i-k} \text{ are based on same MVA.}$$

Converted to ohms seen from side A, and 2 transformers

paralleled:

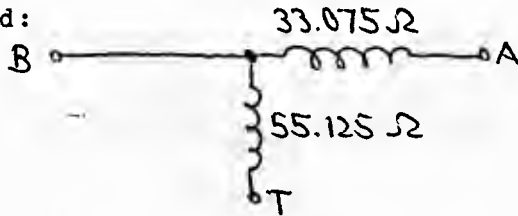

Next, set up the positive sequence and zero sequence networks and combine the reactances.

Positive sequence:

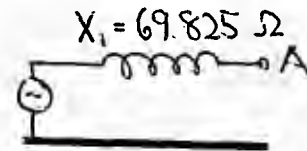
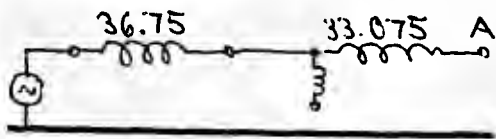

Zero sequence (tertiary in delta and unloaded):

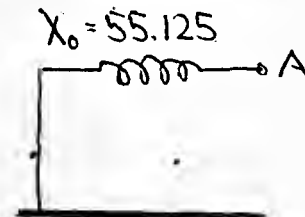
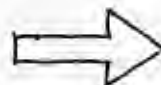
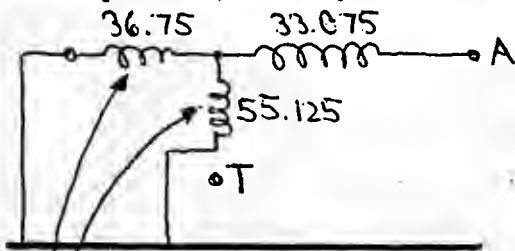

Tertiary node T is isolated, reactance of T-leg is grounded.

2 values in parallel = 22.05 Ω

Finally, transform sequence quantities to phase quantities and represent as follows:

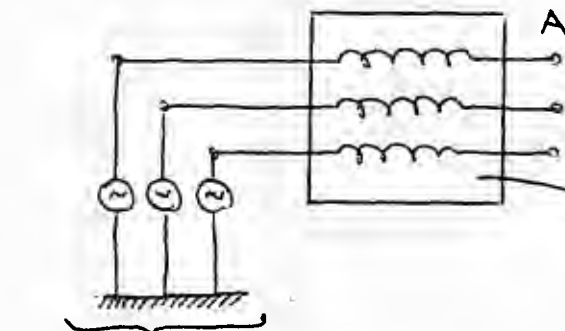

voltage source referred to side A, e.g., $1050\sqrt{3}$ kV peak value (phase $\sqrt{3}$ ground) in this example.

Coupled inductances represented by 3x3 matrix

$$[X_{\text{phase}}] = \begin{bmatrix} X_s & X_m & X_m \\ X_m & X_s & X_m \\ X_m & X_m & X_s \end{bmatrix}$$

with:
self reactance $X_s = \frac{1}{3}(X_0 + 2X_1)$,
mutual reactance $X_m = \frac{1}{3}(X_0 - X_1)$

(In example, $X_s = 64.925 \Omega$, $X_m = -4.9 \Omega$).

6.2 More detailed model for single-phase units

The model described in 6.1 is often inadequate, e.g., for cases with low voltage side switching, with faults on the tertiary side etc. In such cases a more detailed model should be used. The one described here is more detailed in that sense, but it is still approximate and only valid if

- 1) the frequencies in the transients are not too high, and
- 2) three-phase banks consist of single-phase units.

A similar model could also be developed for three-phase units by transforming the equations of the equivalent circuits in the positive, negative and zero sequence (including phase shifts) to equations in phase quantities.

6.21 Basic Approach

A single-phase two-winding transformer can be treated as two inductively coupled branches with a branch impedance matrix $[Z] = [R] + j\omega[L]$.

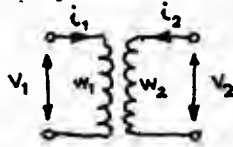

Then the transformer is described by the equation

$$\begin{bmatrix} v_1 \\ v_2 \end{bmatrix} = \begin{bmatrix} R \\ R \end{bmatrix} \begin{bmatrix} i_1 \\ i_2 \end{bmatrix} + \begin{bmatrix} L \\ L \end{bmatrix} \begin{bmatrix} di_1/dt \\ di_2/dt \end{bmatrix} \quad (1)$$

The impedance matrix $[R] + j\omega[L]$ is the inverse of the well-known admittance matrix which is used in steady state studies,

$$[Y] = [Z]^{-1} = \begin{bmatrix} (Y_\ell + \frac{1}{2} Y_m) & -kY_\ell \\ -kY_\ell & k^2 \cdot (Y_\ell + \frac{1}{2} Y_m) \end{bmatrix} \quad (2)$$

with

$$k = \frac{w_1}{w_2} = \text{transformer ratio}$$

$$\omega L_\ell = 1/Y_\ell = \text{leakage impedance seen from side 1,}$$

$$\omega L_m = 1/Y_m = \text{magnetizing impedance seen from side 1.}$$

The "XFORMER" supporting routine which is described in Section 7.1 obtains the impedance matrix by inverting the matrix $[Y]$ of Eq. (2). Of course this works only if $[Y]$ is not singular, which means that the magnetizing admittance Y_m must not be zero. The resulting impedance matrix can be used directly in the EMTP for representation of a transformer, without any modification; matrices $[R]$ and $[L]$ are to be punched on branch cards of Type 51, 52, etc. (see Section 1.24).

If the magnetizing admittance is ignored, as is often done in steady-state studies, then $[R] + j\omega[L]$ is infinite and only its inverse

$$[R] + j\omega[L]^{-1}$$

exists. By ignoring the resistance, Eq. (1) can be re-written as

$$[L]^{-1} \begin{bmatrix} v_1 \\ v_2 \end{bmatrix} = \frac{d}{dt} \begin{bmatrix} i_1 \\ i_2 \end{bmatrix} \quad (3)$$

Eq. (3) could also be used in the TRANSIENTS PROGRAM, but it would require some modifications. This approach was described by W. E. Feero, J. A. Juves and R. W. Long, "Circuit breaker and transformer models for the solution of wavy propagation in distributed-parameter systems," IERE Trans., Vol. PAS-90, May/June 1971, pp. 1000-1006. I do not know how the resistances could or should be re-introduced in this approach.

For 2-winding transformers, current thinking at BPA is that the user should always use the saturable transformer component of Section 1.25, rather than the impedance matrices of the present section. Writing of the present section predates development of the "TRANSFORMER" component, which in addition provides for a built-in nonlinearity. Yet, for some 3-winding configurations, several people have observed problems of instability with the "TRANSFORMER" component — as evidenced by the exponential growth of "noise", which eventually produces an overflow bomb-off by the system. Until this enigmatic complication is understood and fully controlled, the use of $[R]$ and $[L]$ matrices for transformer representation will continue to have a place, it is felt. Also, for four or more windings, Hermann has pointed out that the "TRANSFORMER" representation is not as general in some ways, and hence not equivalent.

Scott Meyer, Feb. 1977

6.22. Validity of transformer models obtained using "XFORMER"

Representing 2- and 3-winding transformers as coupled impedances in the form of impedance matrices is valid as long as the capacitances between windings, from windings to the tank and core and between layers of windings can be ignored. This is permissible for moderate frequencies in the transient phenomena (I guess the models are o.k. up to about 2-5 kHz, but this guess should be substantiated by experts on transformers). The model is probably accurate enough for switching surge studies. It is not adequate for lightning surge studies and it may be questionable for recovery voltage studies. Maybe the model can be improved for such cases by adding capacitances (some capacitance data is available from the test reports), but this requires further investigation. The inadequacy for very high frequencies is obvious because the capacitances determine the behavior of the transformer at very high frequencies since the capacitive impedances $1/\omega C$ become very low and the inductive impedances ωL become very high (and, therefore, negligible).

The model from "XFORMER" has one further limitation: It is only valid for single-phase transformers, including three-phase banks made up of single phase units. In general, the model is not correct for three-phase units, especially if the zero sequence short-circuit input impedance differs from the positive sequence short-circuit input impedance, as in core-form construction. For shell-form construction the model may be adequate for three-phase units, but this requires further investigation. The user is advised to always consult someone who has had experience with EMTP transformer modeling, should he have questions.

6.23 Accuracy check on impedance matrix derived by "XFORMER"

Since the magnetizing impedance is very large compared to the short-circuit input impedance, there is always a danger that the short-circuit input impedance gets lost in the values of the impedance matrix. Such cases will be terminated with an error message:

```
SINGLE-PHASE 3-WINDING TRANSFORMER. IMAGN =-0.00000 PERCENT BASED ON 300MVA
VOLTAGE ACROSS WINDING
(KV)
HIGH 303.00 HIGH TO MEDIUM 0.00 9.4600 300.000
MEDIUM 139.60 HIGH TO LOW 0.00 42.3600 300.000
LCW 34.50 MEDIUM TO LOW 0.00 31.8400 300.000
```

ADMITTANCE MATRIX TOO CLOSE TO SINGULAR. TO BE INVERTIBLE

For further questions, consult Program Maintenance. Also, consider the representation of Section 1.25 ("TRANSFORMER"), for which singularity is no complication. With the saturable transformer component, an infinite magnetizing impedance is perfectly acceptable.

6.24 How to use the model in the TRANSIENTS PROGRAM

A single-phase 2-winding transformer must be read in as 2 coupled branches (first branch A1 to A2, second branch B1 to B2) with the branch having type-codes 51 and 52 (see Section 1.24). There will be three resistance and three inductance (or reactance) values to be punched, since only the lower triangle of [R] and [L] are required.



5. Floating delta connection

If transformer windings are connected in delta and nothing else, such as a line, is connected to it, then the delta is "floating." In a floating delta connection, the voltages to ground are not defined but only the voltages across the windings. This leads to a singular matrix with a respective error message termination. Therefore, either ground one terminal or add ground capacitances.

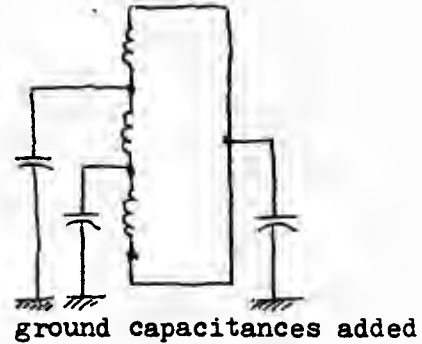
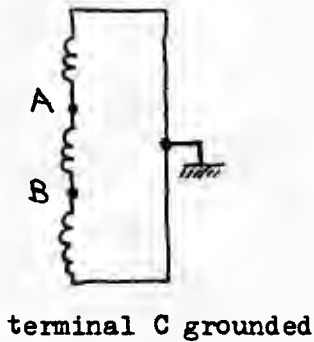
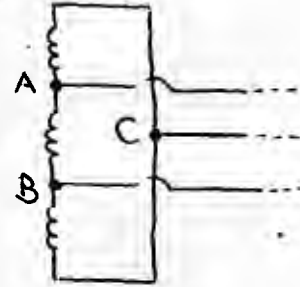

6. Saturation

The impedance matrix produced by the program does not include saturation effects. I think that saturation can be represented with sufficient accuracy by adding a nonlinear inductance across one winding only, say on the high side. This nonlinear inductance will be in parallel with the unsaturated value of the magnetizing inductance. Example: If the saturation curve is defined by 3 points at $i_m = 0.03\%$, 0.06% and 0.12% and if 0.03% was used as magnetizing current for finding the impedance matrix, then the value of 0.03% must be subtracted in defining this nonlinear inductance (dashed line in Fig.).

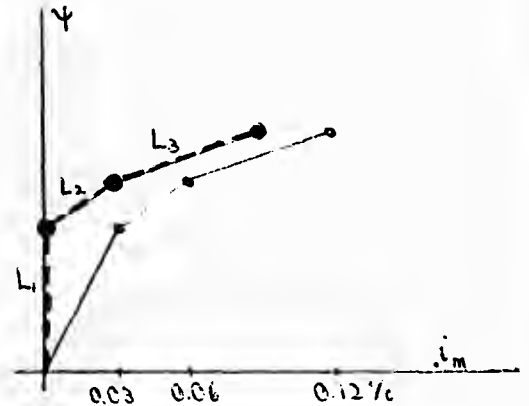

7. User's instructions

See pages 94-96.

8. Test example

See pages 97 to 100 .

7. AUXILIARY SUPPORTING ROUTINES

Several supporting computer routines are used in conjunction with the EMTP proper, to generate or modify input data. Writeups for these routines are to be found on the following pages of this section. While originally used as separate programs, they have been pulled into the structure of the EMTP for completeness.

To execute any one of these routines in place of any regular EMTP data case (see Sect. 1. definition), one simply punches the correct key word in columns 1 onward of the first non-comment card. This is as per Sect. 1.0g, where the following 7 routines are available:

KEYWORD =	"JMARTI SETUP"	is a request for the routine of Sect. 7.0 , which calculates transmission line parameters which are needed for the EMTP modeling of the circuit using Marti modeling.
	"XFORMER "	is a request for the transformer impedance-matrix routine of Sect. 7.1 .
	"SATURATION"	is a request for the magnetic-saturation routine of Sect. 7.2; it also provides access to the magnetic hysteresis-loop generating routine of Sect. 7.2a (for use with Type-96 element).
	"LINE CONSTANTS"	is a request for the overhead line constants calculation routine of Sect. 7.4 . Before 1976, this existed as a separate entity under the name of "BPA Line Constants Program".
	"SEMLYEN SETUP"	is a request for the routine of Sect. 7.5 , which calculates transmission line (or cable) parameters which are needed for the EMTP modeling of the circuit using Semlyen recursive convolution. See "HAUER SETUP".
	"CABLE CONSTANTS"	is a request for the routine of Sect. 7.7 , which calculates resistance, inductance, and capacitance matrices for cable systems.

Following this request card, data cards applicable to the appropriate routine (see following pages) are to be placed.

Note that if desired, any or all of these supporting routines can be executed in the same computer run, sandwiched in any order among regular transients cases (if any).

7.0 "JMARTI SETUP" Routine

By means of the special request word "JMARTI SETUP", an EMTF user gains access to the supporting routine which bears this same name, as per the explanation of Section 7. The principal function of this code is to punch the branch cards which are needed for the representation of a transmission circuit using Marti modeling. See Section 1.26c for theoretical details of the model.

7.0-A Structure of "JMARTI SETUP" data deck

The input data cards are to be structured as the following when one wants to use "JMARTI SETUP" routine.

- M1. First comes a "BEGIN NEW DATA CASE" card (actually optional, as per Section 1.0a).
- M2. Next comes a "JMARTI SETUP" card, which serves to transfer control to the overlay in question (UTPF overlay 39).
- M3. Next come the optional "BRANCH" request cards which are to name the nodes (A6 information) at each end of each phase of the transmission circuit.
- M4. One single, complete data case for "LINE CONSTANTS" (see Sect. 7.4). The first card of this grouping must read "LINE CONSTANTS"; two blank cards will end the grouping (the first to end frequency cards, and the second to end data cases within the supporting program in question). The frequency cards should be prepared according to the following order and rules:

Untransposed line ---- THREE frequency cards are needed:

1. A single frequency is inputted on the 1st frequency card at which the transformation matrix for converting between phase-modal domains is calculated. The default value is 5000 Hz.
2. A single frequency is inputted on the 2nd frequency card with frequency equal to that of steady state.
3. The third frequency card requests the logarithmic looping over all frequencies which are required by the frequency domain fit of "JMARTI SETUP". Typically this will cover 8 or 9 decades beginning from .01 Hz with 10 points per decade.

Transposed line ---- TWO frequency cards are required, namely, the 2nd and 3rd of the frequency cards described in the last paragraph.

- M5. Next comes a group of cards specifying Marti's fitting parameters. It is recommended to run with all the default parameter values; and under this condition ONE single card which reads "DEFAULT" (column 1 to 7) is all it needs. If one chooses to input some or all these parameters, the following definitions should be helpful.

1) Miscellaneous Data card

IDEBUG	IPUNCH	KOUTPR	GMODE
I8	I8	I8	I8

IDEBUG : (1 TO 4) Diagnostic printout control. A value of 1 is recommended for normal runs: information is given on the number of poles and zeroes and the accuracy of the fit for each corners allocation loop.

IPUNCH: 0 ==> line parameters are to be punched.
1 ==> no punch

KOUTPR: Control parameter for amount of output print-out in the resultant "JMARTI SETUP" branch cards when used in the transient simulation case. The value of KOUTPR can be 0, 1 or 2. This is then outputted as SKIP on the branch card. See the detail description of "SKIP" under rule 1 on p. 151.

GMODE: Used only if GPHASE is not specified in "LINE CONSTANTS" data. Conductor conductance in the modal domain (same as phase conductors to ground conductance if it is assumed to be the same for all phases with no mutual conductance between phases). Default is 3.E-8 mhos/km (4.8E-8 mhos/mile). The length unit should be the same as the one used in "LINE CONSTANTS" data.

2) Characteristic Impedance (Zc) Fitting card

NEXMIS	EPSTOL	NORMAX	IECODE	IFWTA	IFPLOT	IFDAT	INELIM
I8	I8	I8	I8	I8	I8	I8	I8

NEXMIS: Normally blank. Nonzero NEXMIS indicates the mode number for which a different fitting card is to be supplied. Blank means that all modes of Zc will use the same fitting card. Example of NEXMIS different from blank: NEXMIS=3 means that the characteristic impedance of the third mode is to be fitted according to a new fitting card.

EPSTOL: Average fit per cent error. Error is evaluated in a least-squares sense and averaged over a range that excludes initial or final asymptotic regions (by 0.001%). Default is 0.30%.

NORMAX: Maximum order (number of poles) to be allowed in the approximation. Default is 30.

IECODE: { 0 → EPSTOL criteria determines the order of the approximation.
 1 → EPSTOL has no effect and the best fit with an order < or = NORMAX is to be selected.

(Note: When using EPSTOL criterion {default}, it is possible that a fit within this tolerance margin cannot be found. This information is given only when IDEBUG > or = 1. Increasing NORMAX might allow the EPSTOL criterion to be met, but in some cases even within a large NORMAX margin a fit with an error less than EPSTOL might not be found. This does not necessarily mean, however, that the resulting fit is not "good" enough.)

IFWTA : { 1 → Table comparing the magnitude and phase angle of the data function and the approximation is printed.
 0 → No table is printed.

IFPLOT: { 1 → Printer plot comparing function and approximation is printed.
 0 → No printer plot.

IFDAT : { 1 → Table with data from "LINE CONSTANTS" and derived quantities is printed.
 0 → No table is printed.

INELIM: { 0 → Order increase stops if error becomes 5 times larger than previous minimum.
 1 → Order increases regardless of error increase until NORMAX or EPSTOL limits are met.

3) Weighting Function (A1) Fitting Card

NEXMIS	EPSTOL	NORMAX	IECODE	IFWTA	IFPLOT	IFDAT	INELIM	AMINA1
18	18	18	18	18	18	18	18	18

Parameters NEXMIS, EPSTOL, NORMAX, IECODE, IFWTA, IFPLOT, IFDAT and INELIM have the same meaning as in the Zc fitting card with the following comments:

- i) A negative integer value -N for NEXMIS means that a different A1 fitting card is to be inputted for the Nth mode of A1.
- ii) In the case of A1, the error for the EPSTOL criterion is checked between an initial asymptotic horizontal margin of .001% as in Zc, but only up to a final value of 1/4 of the previous peak (1/4 of the initial value if there are no local peaks).

BEGIN NEW DATA CASE

C BENCHMARK DCNEW-3
 C TEST OF "JMARTI SETUP" FEATURE, USING THE 500-KV OVERHEAD
 C LINE FROM JOHN DAY TO LOWER MONUMENTAL AS AN EXAMPLE. THIS IS A
 C SINGLE-CIRCUIT BPA LINE WITH TWO GROUND WIRES AND WITH EACH PHASE
 C CONSISTING OF A BUNDLE OF TWO CONDUCTORS. LINE LENGTH = 138. MILES.
 C CONSTANTS FOR THE CIRCUIT ARE CALCULATED USING "LINE CONSTANTS".
 C THE PUNCHED-CARD OUTPUT ON LUNIT7 WILL BE USED IN TEST CASE
 C DCNEW4.DAT.

JMARTI SETUP

BRANCH JDA LMA JDB LMB JDC LMC

LINE CONSTANTS

C LINE CONSTANTS DATA FOR JOHN DAY TO LOWER MONUMENTAL 500-KV LINE.

1.3636	.05215	4	1.602	-20.75	50.	50.
1.3636	.05215	4	1.602	-19.25	50.	50.
2.3636	.05215	4	1.602	-0.75	77.5	77.5
2.3636	.05215	4	1.602	0.75	77.5	77.5
3.3636	.05215	4	1.602	19.25	50.	50.
3.3636	.05215	4	1.602	20.75	50.	50.
0.5	2.61	4	0.386	-12.9	98.5	98.5
0.5	2.61	4	0.386	12.9	98.5	98.5

BLANK CARD ENDING CONDUCTOR CARDS OF &LINE CONSTANTS& CASE

100.	5000.	1	138.	1	1
100.	60.00	1	138.	1	1
100.	.01	1	138.	1	9 10 1

BLANK CARD ENDING FREQUENCY CARDS OF "LINE CONSTANTS" CASE

BLANK CARD ENDING "LINE CONSTANTS" CASES

C 34567890123456789012345678901234567890123456789012345678901234567890

C LECT	+0	-3						
	1							
	.30	30	0	1	1	0	0	
	.30	30	0	1	1	0	0	.0

BLANK CARD ENDING "JMARTI SETUP" CASES

BEGIN NEW DATA CASE

BLANK

7.1 "XFORMER" Routine

Supporting routine "XFORMER" is used to derive matrices $[R]$ and $[L]$ of Section 1.24, which can be used to provide a linear representation for a single-phase, two or 3-winding transformer. Punched card output of "XFORMER" are used as the branch cards of Section 1.24.

Section 1.25 describes the EMTP saturable "TRANSFORMER" component, which provides an EMTP representation for a transformer with an arbitrary number of windings. For most usage, the representation of Section 1.25 is preferred, and usage of the present section will not be required. But there are exceptions, so read on!

For 2-winding transformers, the saturable "TRANSFORMER" component of Section 1.25 is believed to be equivalent to or better (more general, and more convenient) than representation by means of matrices $[R]$ and $[L]$ (EMTP branches of type-code 51, 52, etc.). Hence it is not recommended that supporting routine "XFORMER" be used in the 2-winding case, except in very special cases.

But numerical instability has been observed in certain cases where 3-winding saturable "TRANSFORMER" components have been used. This is not in all cases, nor even in most cases. But in several cases between 1975 and 1977, trouble was encountered, as further discussed in Section 1.25. Hence supporting routine "XFORMER" continues to have production application, for 3-winding transformers.

Data-Deck Structure for 3-Winding Usage

Suppose that the user wants to generate Type 51-53 branch cards for the EMTP representation of one or more 3-winding single-phase transformers. His data deck then will have the following structure:

1. First comes a "BEGIN NEW DATA CASE" card (actually optional, as per Section 1.0a).
2. Next comes an "XFORMER" special-request card, which serves to transfer control to the overlay in question (UTPF overlay #41).
3. Next comes an optional "BRANCH" card (if any), which names the terminal nodes of the transformer windings for subsequent EMTP usage.
4. Next come four data cards which give electrical parameters of the transformer.
5. Repeat the data of Point 3 and Point 4 as many times as desired. Each such grouping is a separate data case within "XFORMER", corresponding to a different transformer. A blank card terminates these.
6. If the user wants to shut off the EMTP at this point (rather than execute a following EMTP data case), he should simply add a "BEGIN NEW DATA CASE" card at this point, followed by a blank card. This is as per Section 1.0b.

Format for Point 3 "XFORMER" Data ("BRANCH" card)

If the user wants punched-card output (variable "IPUNCH" of Point 4 "XFORMER" data), then terminal node names may be desired. Without such information, the Type 51-53 branch cards which will be punched will have fields "BUS1" and "BUS2" of columns 3-14 blank.

The user can supply branch names "BUS1" and "BUS2" for all transformer windings by means of the following card:

BRANCH	Type-51 (high)		Type-52 (medium)		Type-53 (low)	
	BUS1	BUS2	BUS1	BUS2	BUS1	BUS2
	AG	AG	AG	AG	AG	AG

Note that the key word "BRANCH" is punched in columns 1-6. Then pairs of names are supplied for the three windings, with the high-voltage winding coming first (row 1 of the printed matrix; Type-51 branch card of the punched output); then comes the intermediate-voltage winding (row 2 of the printed matrix; Type-52 branch card of the punched output); finally there is the low-voltage winding (row 3 of the printed matrix; Type-53 branch card of the punched output).

Format for Point 4 "XFORMER" Data

For a 3-winding single-phase transformer, the Point 4 "XFORMER" data consists of four cards. The first of these has the following format:

NW	CMAGN	PBCUR	IPUNCH
3	E9.0	E10.0	18

NW ----- The number of transformer windings ("3" as used here).
(1)

CMAGN ----- The transformer magnetizing current in percent, consistent
(2-10) with the base power "PBCUR".

PBCUR ----- Single-phase base power of the transformer in MVA,
(11-20) for use with the "CMAGN" specification.

IPUNCH --- Flag which controls the possible punching of Type 51-53
(25-32) branch cards as output:

{ 0 ⇒ Yes, punch the cards;
1 ⇒ No punched card output.

Free-format separation and continuation characters "CSEPAR" and "CHCONT" will be used on all punched cards (see sample output to follow, and definition of Section 1.0g6). Of course the usage of such characters must be consistent, between the "XFORMER" run and the subsequent electric-network simulation which uses the punched cards.

The data is completed by three additional cards, each of which has four numbers punched on it. The following subscript meaning is assumed:

- "1" ----- high voltage winding;
- "2" ----- medium voltage winding;
- "3" ----- low voltage winding.

Then the three data cards in question contain the following information:

VOLT ₁	PLOSS ₁₂	ZSC ₁₂	PBZ ₁₂
VOLT ₂	PLOSS ₁₃	ZSC ₁₃	PBZ ₁₃
VOLT ₃	PLOSS ₂₃	ZSC ₂₃	PBZ ₂₃
E10.0	E10.0	E10.0	E10.0

- VOLT_i ----- Voltage rating of winding number "i", in units of RMS kV .
- PLOSS_{ij} ----- Single-phase transformer load loss in kilowatts, when transmitting rated power between winding "i" and winding "j" .
- ZSC_{ij} ----- Short-circuit impedance of the transformer between winding "i" and winding "j", in units of per cent based on the power PBZ_{ij} .
- PBZ_{ij} ----- Single-phase base power in MVA , upon which ZSC_{ij} is based.

Sample "XFORMER" Data Case

Consider 3-winding usage of "XFORMER" as per one of the data cases within BENCHMARK DC-15. This has been set up as a separate EMTP data case, for purposes of illustration. A listing of this problem follows:

```

BEGIN NEW DATA CASE ~ Point 1 data
C   UTPF TEST CASE NO. 42 ----- INTERIOR SUBCASE TAKEN THEREFROM.
XFORMER ~ Point 2 data
BRANCH NAME1 NAME2 NAME3 NAME4 NAME5 NAME6 ~ Point 3 data
3      0.3      83.3      6.7      83.3
      132.8     250.      5.1      18.96
      66.4      56.8      3.2      18.96
      13.2      56.8
Blank card ending "XFORMER" cases ~ Point 5 data
BEGIN NEW DATA CASE } ~ Point 6 data
Blank card
    
```

EMTP line printer output of the solution then appears as shown below. Note that a listing of the punched cards is always obtained, to document the branch-card output (which will be used in subsequent EMTP electric-network simulations). The free-format usage of these cards should be evident. It is seen that a comma (",") is being used for the field-separation character "CSEPAR", and a dollar sign ("\$") is being used for the continuation character "CHCONT". Since not redefined in the data case using the "FREE FORMAT" special request card of Section 1.0g6, this character choice was implicit to the EMTP being used (as defined within system-dependent module "SYSDEF" of UTPF overlay #1). Six data cards are used for the high-precision input of what would otherwise only require three cards, had the fixed-format specification of Section 1.24 been used.

ELECTROMAGNETIC TRANSIENTS PROGRAM (EMTP), CDC TRANSLATION PRODUCED BY THE BONNEVILLE POWER ADMINISTRATION, PORTLAND, OREGON. DATE (MM/DD/YY) AND TIME OF DAY (HH.MM.SS) = 09/03/77 13.03.57 ANY PLOTS BEAR THE SAME FIGURES. IF IN DOUBT AS TO WHAT THE FOLLOWING PRINTOUT MEANS, CONSULT THE 259-PAGE EMTP USER'S MANUAL DATED JANUARY, 1976. INDEPENDENT LIST LIMITS FOLLOW. TOTAL LENGTH OF /LABEL/ EQUALS 1178 INTEGER WORDS.

10 10 10 5 10 5 10 10 5 80 80 1 20 50 4 2 5 1 1

DESCRIPTIVE INTERPRETATION OF NEW-CASE INPUT DATA | INPUT DATA CARD IMAGES PRINTED BELOW, ALL 80 COLUMNS, CHARACTER BY

0	1	2	3	4	5	6
0	0	0	0	0	0	0

MARKER CARD PRECEDING NEW DATA CASE. | BEGIN NEW DATA CASE

COMMENT CARD. | C UTPF TEST CASE NO. 42 ----- INTERIOR SUBCASE TAKEN THEREFF

REQUEST FOR TRANSFORMER IMPEDANCE-MATRIX ROUTINE. | XFORMER

NODE NAMES FOR PUNCHED BRANCH CARDS. | BRANCH NAME1 NAME2 NAME3 NAME4 NAME5 NAME6

NEW DEVICE.	3	.300000E+00	.833000E+02	-0	13	0.3	83.3	0		
WIND.	.133E+03	.250E+03	.676E+01	.833E+02	1	132.6	250.	6.7	83.3	
WIND.	.664E+02	.568E+02	.510E+01	.190E+02	1	66.4	50.8	5.1	18.96	
WIND.	.132E+02	.568E+02	.320E+01	.190E+02	1	13.2	56.8	3.2	18.96	

SINGLE-PHASE 3-WINDING TRANSFORMER. *IMAGN* = .30000 PER CENT BASED ON 83.300 MVA

VOLTAGE ACROSS WINDING (KV)		LOSSES (KW)		IMPEDANCE BASED ON (PER CENT) (MVA)	
HIGH	132.80	HIGH TO MEDIUM	250.00	6.7000	83.300
MEDIUM	66.40	HIGH TO LOW	56.80	5.1000	18.960
LOW	13.20	MEDIUM TO LOW	56.80	3.2000	18.960

IMPEDANCE MATRIX AS REQUIRED FOR T.P. STUDIES (WITH *X* IN OHMS AT THE POWER FREQUENCY)

	R	X	R	X	R	X
HIGH	.4507137E+00	.7058197E+05				
MEDIUM	.6653229E-01	.3526596E+05	.1126929E+00	.1764402E+05		
LOW	-.5802603E-01	.7013580E+04	-.2901588E-01	.3507084E+04	.1153580E-01	.6973924E+03

80-COLUMN CARD-IMAGE LISTING OF PUNCHED-CARD OUTPUT FOLLOWS (TYPE-51-53 ENTP BRANCH CARDS).

1	2	3	4	5	6	7	8
0	0	0	0	0	0	0	0

51NAME1 NAME2 .4507136759200E+00 , .7058196750567E+05 , , , ,

52NAME3 NAME4 .6653228709255E-01 , .3526596466072E+05 \$

.1126928513769E+00 , .1764401526697E+05 , , , ,

53NAME5 NAME6 -.5802602978074E-01 , .7013580395482E+04 \$

-.2901588397677E-01 , .3507083720562E+04 \$

.1153587752842E-01 , .6973923570124E+03 , , , ,

SHORT-CIRCUIT INPUT IMPEDANCES WHICH ARE OBTAINED FROM THE JUST-PRINTED IMPEDANCE MATRIX, BY REVERSE COMPUTATION. THIS IS SORT OF A CHECK ON THE COMPUTATION.

HIGH TO MEDIUM	.63532	14.16969
HIGH TO LOW	2.78458	47.34108
MEDIUM TO LOW	.69626	7.40642

REPEAT OF PRECEDING CALCULATION, ONLY THIS TIME THE STARTING POINT WILL BE THE IMPEDANCE MATRIX WITH ALL ELEMENTS ROUNDED TO FIVE DECIMAL DIGITS.

HIGH TO MEDIUM	.63531	13.99977
HIGH TO LOW	2.78459	47.34462
MEDIUM TO LOW	.69626	7.41954

BLANK CARD TERMINATING *XFORMER* CASES. |

ELECTROMAGNETIC TRANSIENTS PROGRAM (EMTP), CDC TRANSLATION PRODUCED BY THE BONNEVILLE POWER ADMINISTRATION, PORTLAND, OREGON. DATE (MM/DD/YY) AND TIME OF DAY (HH.MM.SS) = 09/03/77 13.04.03 ANY PLOTS BEAR THE SAME FIGURES. IF IN DOUBT AS TO WHAT THE FOLLOWING PRINTOUT MEANS, CONSULT THE 259-PAGE EMTP USER'S MANUAL DATED JANUARY, 1976. INDEPENDENT LIST LIMITS FOLLOW. TOTAL LENGTH OF /LABEL/ EQUALS 1178 INTEGER WORDS.

10 10 10 5 10 5 10 10 5 80 80 1 20 50 4 2 5 1 1 1

DESCRIPTIVE INTERPRETATION OF NEW-CASE INPUT DATA | INPUT DATA CARD IMAGES PRINTED BELOW, ALL 80 COLUMNS, CHARACTER BY

0	1	2	3	4	5	6
0	0	0	0	0	0	0

MARKER CARD PRECEDING NEW DATA CASE. | BEGIN NEW DATA CASE

BLANK TERMINATION-OF-RUN CARD. |

Interpretation of "XFORMER" Input Data Cards

There are only four distinct types of non-comment cards which might be read by "XFORMER". The first of these is the optional "BRANCH" card (Point 3 "XFORMER" data), which is interpreted as follows:

1	2	3	4	5	6	7	8	9	10	11	12	13	14	15	16	17	18	19	20	21	22	23	24	25	26	27	28	29	30	31	32	33	34	35	36	37	38	39	40	41	42	43	44	45	46	47	48	49	50	51
NODE NAMES FOR PUNCHED BRANCH CARDS.																																																		1

The first of the cards which make up Point 4 "XFORMER" data is given the interpretation:

1	2	3	4	5	6	7	8	9	10	11	12	13	14	15	16	17	18	19	20	21	22	23	24	25	26	27	28	29	30	31	32	33	34	35	36	37	38	39	40	41	42	43	44	45	46	47	48	49	50	51
NEW DEVICE.											IG					E12.3					E12.3					I7					1																			
											NW					CMAGN					PBCUR					IPUNCH					1																			

The remaining cards of Point 4 "XFORMER" data, one for each winding of the transformer, are interpreted as follows:

1	2	3	4	5	6	7	8	9	10	11	12	13	14	15	16	17	18	19	20	21	22	23	24	25	26	27	28	29	30	31	32	33	34	35	36	37	38	39	40	41	42	43	44	45	46	47	48	49	50	51
WIND.											E11.3					E11.3					E11.3					E11.3					1																			
											VOLT					PLOSS					ZSC					PBZ					1																			

Finally, there is interpretation for the blank card which signals the end of data cases within "XFORMER" (Point 5 "XFORMER" data):

1	2	3	4	5	6	7	8	9	10	11	12	13	14	15	16	17	18	19	20	21	22	23	24	25	26	27	28	29	30	31	32	33	34	35	36	37	38	39	40	41	42	43	44	45	46	47	48	49	50	51
BLANK CARD TERMINATING 'XFORMER' CASES.																																																		1

Possible problem with matrix singularity

If the user specifies too little magnetizing current, then the admittance matrix becomes nearly singular, and it can not be inverted to give the desired matrices [R] and [L]. Floating-point miscellaneous data parameter "EPSILN" (see Section 1.0h) is used as a singularity tolerance (a default value is assigned in module "SYSDEF" of UTPF overlay #1). Should the user's data fail this check, the following message will be printed:

PROBLEM. ---- ADMITTANCE MATRIX FOR TRANSFORMER IS TOO CLOSE TO BEING SINGULAR TO BE INVERTIBLE. HENCE
THE INVERSION WILL BE SKIPPED. PARAMETERS WHICH DOCUMENT THIS BREAKDOWN FOLLOW.

EPSILN
CII
CR

**USER'S INSTRUCTIONS
FOR PROGRAM
TO OBTAIN IMPEDANCE MATRIX OF TRANSFORMERS**

INPUT - 2 cards for each 2-winding, single-phase transformer,
4 cards for each 3-winding, single-phase transformer.

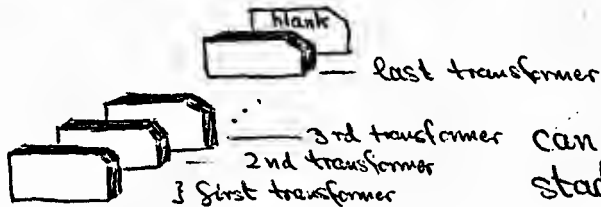

Any number of transformers can be studied with a single run by stacking as many sets of 2 cards (for 2-windg. transf.) or 4 cards (for 3-windg. transf.). Terminate stack with a blank card.

Two-winding, single phase transformers

First card:

	1	2	3	4	5	6	7	8	9	10	11	12	13	14	15	16	17	18	19	20
NO. OF WINDING	MAGNETIZING CURRENT in PER CENT based on power in columns 11-20										SINGLE-PHASE BASE POWER in MVA on which magn. current is based									
	E9.0										E10.0									

always punch [2] in column 1

It is accurate enough to use magn. current = exciting current.

Second card:

	1	2	3	4	5	6	7	8	9	10	11	12	13	14	15	16	17	18	19	20	21	22	23	24	25	26	27	28	29	30	31	32	33	34	35	36	37	38	39	40	41	42	43	44	45	46	47	48	49	50
TAP SETTING in kV ACROSS WINDING										SINGLE-PHASE LOAD LOSSES in kW at rated power										SHORT-CIRCUIT INPUT IMPEDANCE in PER CENT based on power										SINGLE-PHASE POWER BASE in MVA on which impedance is based																				
HIGH SIDE					LOW SIDE																																													
E10.0					E10.0					E10.0										E10.0										E10.0																				

RMS-values. For wye-connections: $\frac{\text{phase-to phase}}{\sqrt{3}}$;
for delta connections: phase-to-phase

is "average test impedance per cent Z₁" in BPA data book ("short-circuit input impedance" is correct name as defined in ANSI C57.12.90-1968 & IEEE Standard No. 262)

is "base kVA" in BPA data book (convert from kVA to MVA!)

Three-winding, single-phase transformers

First card:

	1	2	3	4	5	6	7	8	9	10	11	12	13	14	15	16	17	18	19	20
NO. OF WINDG.	MAGNETIZING CURRENT in PER CENT based on power in columns 11-20										SINGLE-PHASE BASE POWER in MVA on which magn. current is based									
	Format E9.0										E10.0									

always punch **3** in column 1.

It is accurate enough to use magn. current = exciting current.

2nd to 4th card:

	1	2	3	4	5	6	7	8	9	10	11	12	13	14	15	16	17	18	19	20	21	22	23	24	25	26	27	28	29	30	31	32	33	34	35	36	37	38	39	40
TAP SETTING in kV ACROSS WINDING	SINGLE-PHASE LOAD LOSSES in kW at rated power										SHORT-CIRCUIT INPUT IMPEDANCE in PER CENT based on power										SINGLE-PHASE POWER BASE in MVA on which impedance is based																			
	HIGH										HIGH-MEDIUM										HIGH-MEDIUM																			
	MEDIUM										HIGH-LOW										HIGH-LOW																			
	LOW										MEDIUM-LOW										MEDIUM-LOW																			
Format	E10.0										E10.0										E10.0																			

Same comments as for 2-winding transformer

Same comments as for 2-winding transformer

OUTPUT:

Normal output on next page.

Error message if magnetizing current is too low to permit inversion of admittance matrix:

SINGLE-PHASE 2-WINDING TRANSFORMER. IMAGN = -0.00000 PERCENT BASED ON 20.000 MVA
 VOLTAGE ACROSS WINDING LOSSES IMPEDANCE BASED ON
 (KV) (KW) (PER CENT) (MVA)
 HIGH 110.00 HIGH TO LOW 136.00 10.0000 20.000
 LCW 30.00
 ADMITTANCE MATRIX TOO CLOSE TO SINGULAR TO BE INVERTIBLE

2-winding transformer

SINGLE-PHASE 2-WINDING TRANSFORMER. IMAGN = 2.00000 PERCENT BASED ON 6.667 MVA
 VOLTAGE ACROSS WINDING
 (KV) HIGH TO LOW LOSS IMPEDANCE BASED ON
 HIGH 63.50 HIGH TO LOW 45.37 10.0000 6.667
 LOW 17.32

IMPEDANCE MATRIX AS REQUIRED FOR TRANSIENTS PROGRAM (X AT POWER FREQUENCY) P X

HIGH 1.0270884E+00 3.0255441E+04
 LOW -2.8014443E-01 8.2441251E+03 7.6411048E-02 2.2508772E+03

WARNING. IF NOTHING CONNECTED TO WINDINGS IN DELTA, EITHER ADD CAPACITANCES OR GROUND ONE TERMINAL

SHORT-CIRCUIT INPUT IMPEDANCES OBTAINED FROM IMPEDANCE MATRIX
 HIGH TO LOW 4.10426 50.28089
 SAME, EXCEPT ELEMENTS IN IMPEDANCE MATRIX ROUNDED TO 5 DIGITS
 HIGH TO LOW 4.10418 50.32020

TO AVOID UNDEFINED FLOATING

3-winding transformer

SINGLE-PHASE 3-WINDING TRANSFORMER. IMAGN = .30619 PERCENT BASED ON 300.000 MVA
 VOLTAGE ACROSS WINDING
 (KV) HIGH TO MEDIUM LOSS IMPEDANCE BASED ON
 HIGH 303.00 HIGH TO MEDIUM 0.00 9.4600 300.000
 MEDIUM 139.60 HIGH TO LOW 0.00 42.3600 300.000
 LOW 34.50 MEDIUM TO LOW 0.00 31.8400 300.000

IMPEDANCE MATRIX AS REQUIRED FOR TRANSIENTS PROGRAM (X AT POWER FREQUENCY) R X

HIGH -0. 9.9972154E+04
 MEDIUM 0. 4.6050638E+04 0.
 LOW 0. 1.1376889E+04 0.

WARNING. IF NOTHING CONNECTED TO WINDINGS IN DELTA, EITHER ADD CAPACITANCES CR GROUND ONE TERMINAL
 2.1218663E+04
 5.2421922E+03 0. 1.2963764E+03

SHORT-CIRCUIT INPUT IMPEDANCES OBTAINED FROM IMPEDANCE MATRIX

HIGH TO MEDIUM 0.00000 28.94763
 HIGH TO LOW 0.00000 129.54560
 MEDIUM TO LOW 0.00000 20.66977
 SAME, EXCEPT ELEMENTS IN IMPEDANCE MATRIX ROUNDED TO 5 DIGITS
 HIGH TO MEDIUM 0.00000 28.80753
 HIGH TO LOW 0.00000 129.25933
 MEDIUM TO LOW 0.00000 21.32888

TO AVOID UNDEFINED FLOATING

TEST CASE FOR 3-WINDING TRANSFORMER

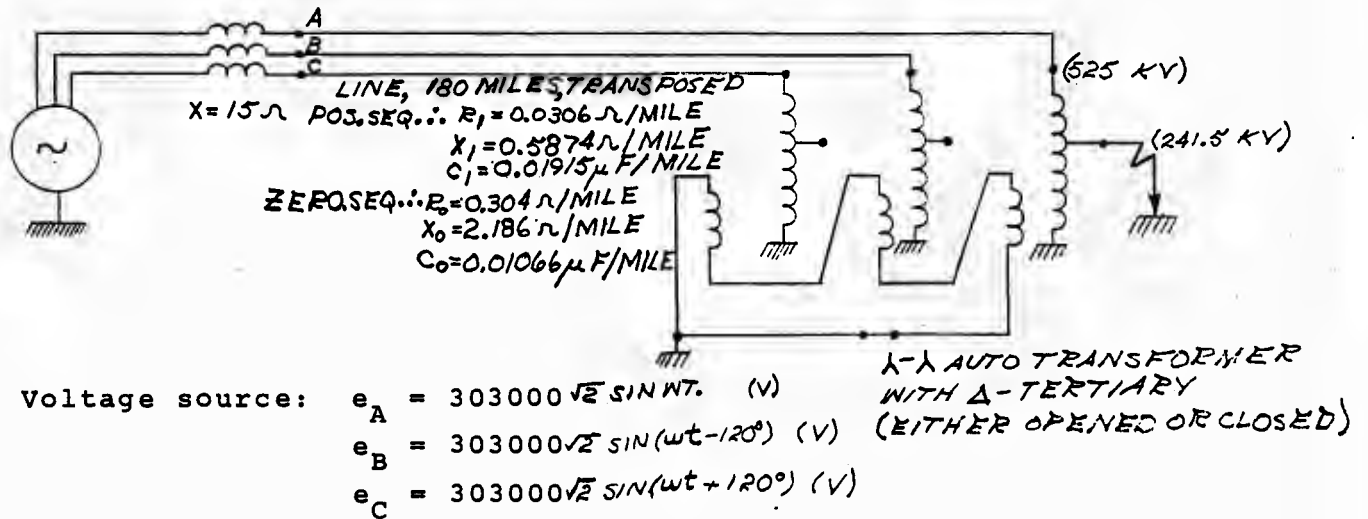

Fault: System is energized at $t < 0$
 Single-line-to-ground fault on phase A of 241.5 kV transformer terminal at $t=0$

Transformer data for each single phase unit (Covington bank):

$I_{\text{magnetization}} = 0.3$ per cent based on 300 MVA (single-phase)

Short-circuit impedances (R ignored):

High to medium	9.46 per cent	} based on 300 MVA (single-phase)
High to low	42.36 per cent	
Medium to low	31.84 per cent	

Tap settings: $\frac{525}{\sqrt{3}}$ kV / $\frac{241.5}{\sqrt{3}}$ kV / 34.5 kV

Results: On the next 2 pages, the voltages on the 525 kV-side and the currents on the 241.5 and 35 kV-side are shown,
 (a) with the tertiary closed,
 (b) with the tertiary open.

An open tertiary produces lower currents but higher overvoltages (1.42 p.u.).

The listing for the input data is attached as the last page.

CLOSED TERTIARY

TEST CASE, THREE-WINDING TRANSFORMER

sustained overvoltage = $320\sqrt{2}$ kV
= 1.055 p.u.

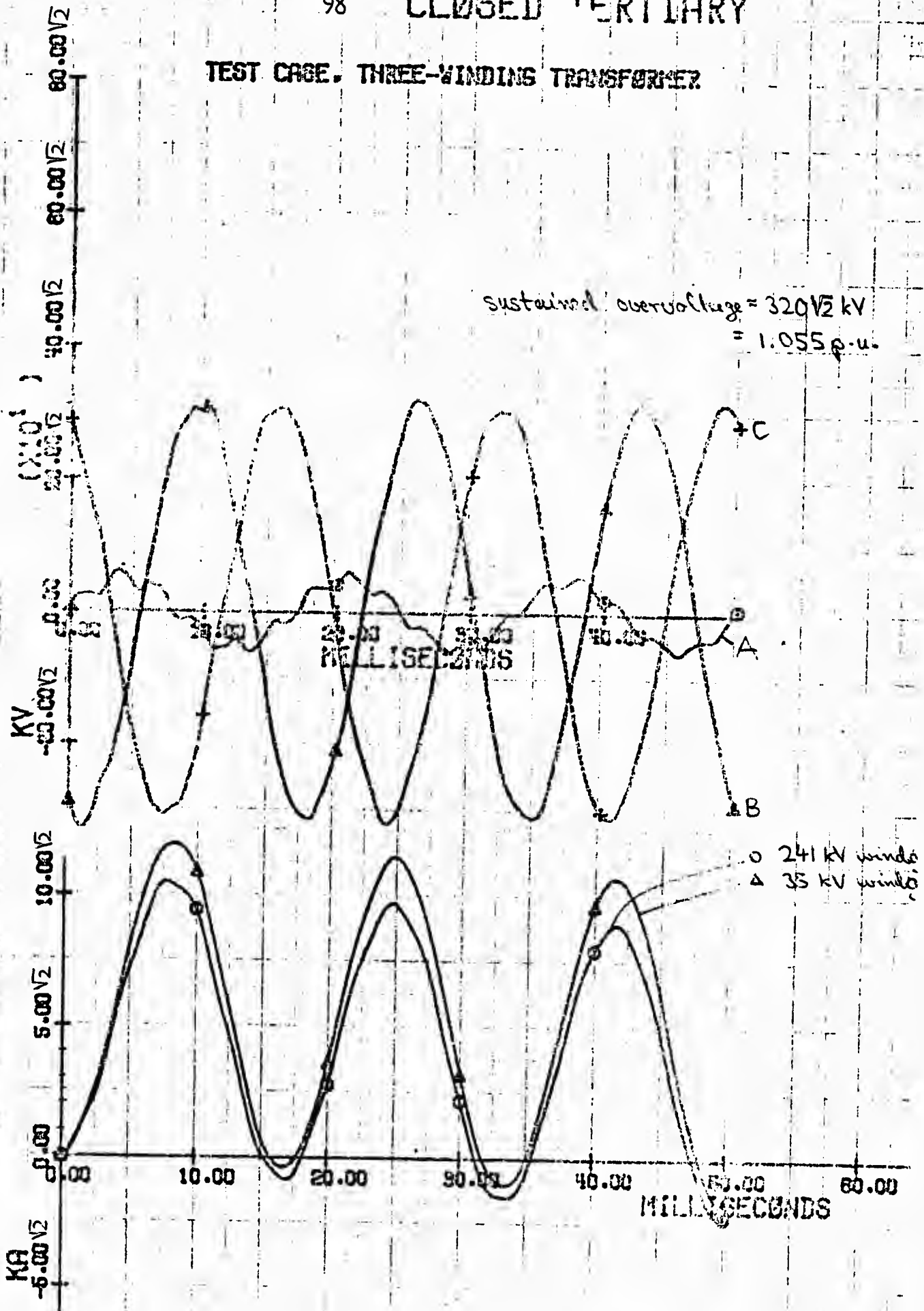

TEST CASE, THREE-WINDING TRANSFORMER

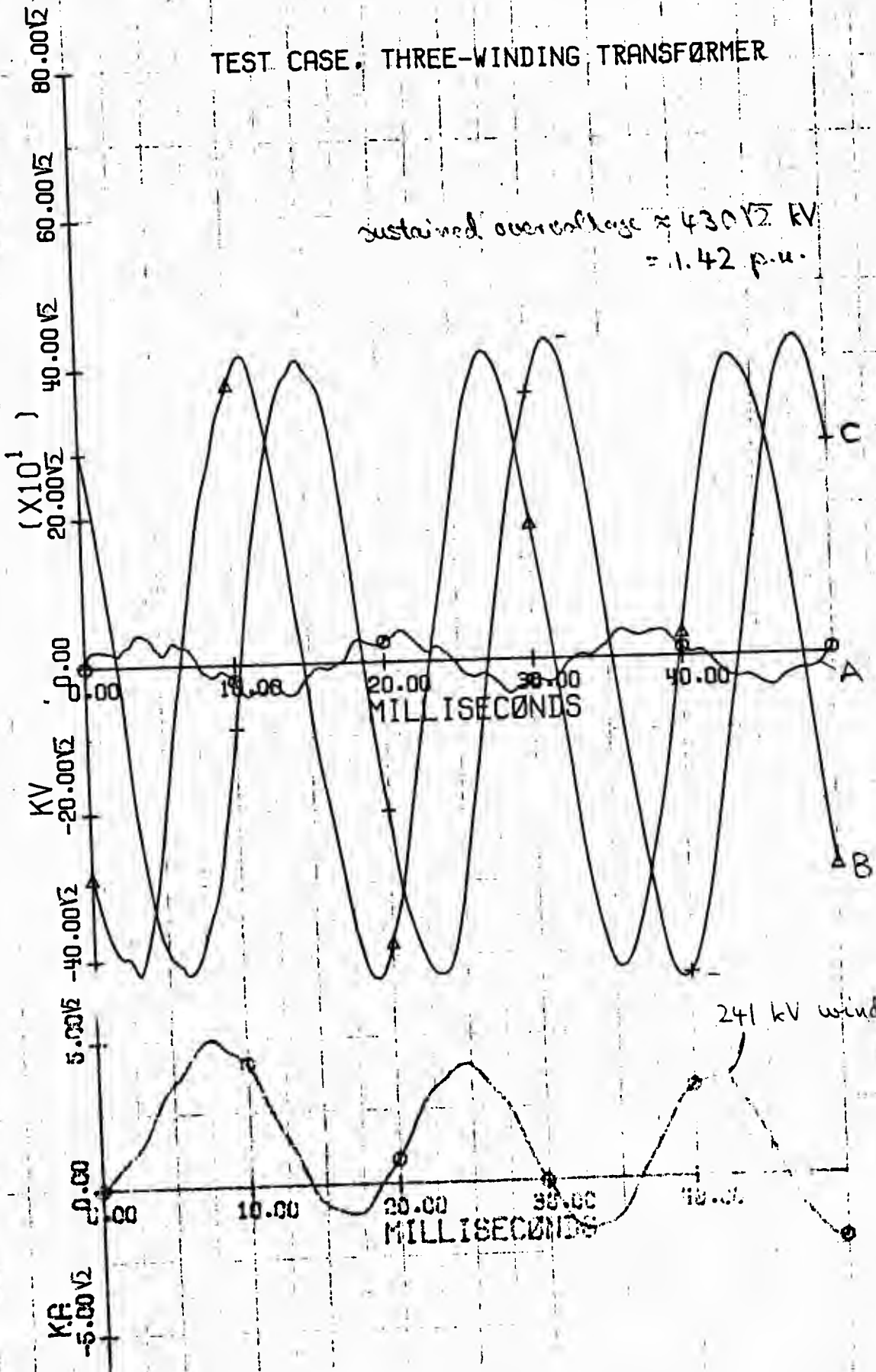

CLOSED TERTIARY

TEST CASE, THREE-WINDING TRANSFORMER
 REGRC OF INFUT - BRANCH DATA (R IN OHM, X IN OHM FOR 60.0 HZ, C IN MICROFARAD)

0 SCURCA S-A 1.500E+01-0.
 0 SCURCB S-B 1.500E+01-0.
 0 SCURCC S-C 1.500E+01-0.
 -1 S-A R-A 3.040E-01 2.186E+00 1.066E-02 1.800E+02 -C -0 ZSURGE= 737.53 TRAVE
 -2 S-B R-B 3.060E-02 5.874E-01 1.915E-02 1.800E+02 -C -0 ZSURGE= 285.24 TRAVE
 -3 S-C R-C

1 R-A 9.9972E04-0.
 2 M-A 4.6051E04-0.
 3 T-A 1.1377E04-0. 2.1279E04-0.
 5.2422E03-0. -0.

1 R-B
 2 M-B
 3 T-B
 1 R-C
 2 M-C
 3 T-C

1 R-A
 2 M-A
 3 T-A
 SHCRT
 SWITCH 0.

5.000E-03-0.
 5.000E-03-0.
 1.00000E+00 -0.

Small inductances were inserted to measure the currents!

1.2964E03-0.

REGRD CF INFUT - SOURCE DATA
 14 SOURCA -0 3.030000E+02 DELTA-T= 1.000000E-04 T-MAX= 5.000000E-02
 14 SOURCB -0 3.030000E+02 -9.000000E+01 -0. -1.000000E+00
 14 SOURCC -0 3.030000E+02 6.000000E+01 -2.100000E+02 -0. -1.000000E+00
 6.000000E+01 3.000000E+01 -0. -1.000000E+00

STEADY STATE OVERLAY ENTERED.
 STEADY STATE CALCULATIONS COMPLETE.

TRIANGULAR MATRIX WITHOUT SWITCH-NODES HAS 59 ELEMENTS

RESULTS SAVED ON FILE FOR PLOTTING. PLOTS WILL USE EVERY 1 CALCULATED POINTS ONLY

FIRST 3 RESULTS ARE NCCE VOLTAGES
 NEXT 0 RESULTS ARE BRANCH VOLTAGES
 FINAL 2 RESULTS ARE CURRENTS

STEP	TIME	R-A	R-E	R-C	M-A	T-C
0	0.	-1.24292E+00	-2.86405E+02	2.87648E+02	-1.81899E-10	-1.76026E-07
100	1.000E-02	-2.59486E+01	3.09287E+02	-1.56464E+02	9.45595E+00	1.09293E+01
200	2.000E-02	4.25708E+01	-2.07887E+02	-2.84064E+01	2.80507E+00	3.64530E+00
300	3.000E-02	-4.34182E+01	3.22811E+01	2.07642E+02	2.20759E+00	3.22378E+00

SWITCH SHORT TO CLOSED AFTER 0. SEC.

Section 7.1A

"TRELEG" ---- a supporting program designed to generate Type 51,52,... branch cards for 3-phase, 3-leg core-type transformers.

Background

The 3-phase, 3-leg, core-type transformer has long been recognized as a problem for EMTP users. Some of the explanation is contained in the fourth and fifth pages of Section 1.25, and that material shall not be repeated here. If the user does not know what a 3-leg transformer is, refer to the sketches and discussion of Section 1.25. Supporting program "TRELEG" (mnemonic derived from "three leg") accepts measurement and configuration data of the transformer as input, and punches EMTP branch cards (Type 51,52,...) for the transformer as output. Written as a separate program by Dr. Vladimir Brandwajn of Ontario Hydro, it was integrated into the EMTP by BPA during May of 1980.

For completeness and perspective, other references to the problem shall be mentioned. The first Newsletter (Ref. 22) mention is in issue No. 2, the article entitled "Model of Three-Leg Core Transformer" by Vladimir and Russ. Hermann had simultaneously and independently been working on the problem, ever since the 1978 Madison EMTP short course (see Ref. 8, Vol. VIII, 30 June 1978, page AOVA-16). Hermann's approach, which was based on the [A],[B] matrix formulation, is numerically advantageous in cases where magnetizing current is low, since he avoids the near singularity of the [R],[L] formulation. See his comments on page 15 of the just-cited Newsletter. But that intended reconciliation of the Vancouver and Toronto codes never took place. Because Vladimir had mailed us (at BPA) a punched card deck of his routine, and because he had written user instructions, it was this code which was frantically massaged and added to the EMTP early in May of 1980. Whether there will be later modifications remains to be seen.

As for Section 1.25 modeling, I would recommend avoiding the "TRANSFORMER THREE PHASE" option at this time. The big problem for all users has been determination of the zero-sequence reluctance R_0 (there is no supporting program comparable to "TRELEG" for deriving this number). BPA never did use this modeling, largely because we can count the number of 3-phase transformers out here on the fingers of one hand (with several fingers to spare!), and because such transformers have not been the subject of recent study interest. Also, the EMTP Newsletter article by Vladimir and Russ cast doubt on the validity of such ("old") representation, though I remain skeptical of the results (there are many ways to get wrong answers out of the EMTP, and not all of them can be blamed on defective modeling!). So, if the user has a 3-leg unit, use "TRELEG", and complain to Toronto (not Portland) if results are less than pleasing!

So, on to the user instructions. The material immediately below was written by Vladimir; it was extracted from the first five pages of USER'S INSTRUCTIONS dated July 24, 1979. The final two pages of that memo constituted an example which is no longer applicable due to input/output format changes. Instead, I have appended a current ("M27." ; May, 1980) solution of one of Vladimir's numerous test cases at the end.

For the program to calculate impedance matrix of a three-legged core transformer.

1.0 General Remarks

The effects of a three-legged core in a transformer are apparent in the different values determined for short-circuit impedances in positive and zero sequence. These values are used by the program to calculate a $(N \times 3) \times (N \times 3)$ impedance matrix model (N = number of windings on any leg, presently $N \leq 5$). It is also possible to use this program to calculate an $N \times N$ matrix to represent a single-legged core, a shell type, or a 5 leg core transformer. In the latter cases, the values of the impedances (short-circuit and magnetizing) will be equal in both sequences.

The program accepts data for short-circuit tests performed with up to two of the windings connected in delta. This is the standard form in which a manufacturer will provide test data.

The data must be input so that delta connected windings appear last. A further, and occasionally conflicting program assumption is that the windings are concentrically located on the core, and input in the order from outer to inner winding. When windings are not concentric, or when the delta connected windings are not innermost on the core, the program provides for the user to retain delta connected windings as the last windings, and to provide the magnetizing impedance of each winding. In the absence of any test data, the positive sequence magnetizing impedance of windings in per unit can be assumed to increase with increasing diameter, while the zero sequence magnetizing impedance decreases. The variation from one winding to another will be approximately equal to the positive sequence short-circuit reactance between them. It is not believed that this approximation of magnetizing impedances has any significant effect on the resulting model.

2.0 Form of DATA Input

Class I

Card #1

N, NDELTA, f, SBVA
FORMAT (1x, 2I2, 2E12.0)
N = # of windings
NDELTA = # of delta winding (≤ 2)
f = frequency in Hz (60 in North America)
SBVA = base MVA (3-phase rating)

Class II (present only if NDELTA = 2)

Card #2 Through 4 (exactly 3 cards)

TPKMR, TPKMX
FORMAT (1X, 2E12.0)
TPKMR, TPKMX are real and imaginary parts of the positive sequence test between two delta windings.

Card #3

IDT

FORMAT (1X, I2)

IDT - # of wye winding for which zero sequence test with two delta windings closed is performed.

Card #4

TZKMR, TZKMX

FORMAT(1X, 2E12.0)

TZKMR, TZKMX are real and imaginary parts of the zero sequence test between wye and two delta windings.

Class III

Card #5 through $5 + \frac{(N-1)(N-2)}{2} + 1$ [for the case with
NDELTA = 2]

If NDELTA < 2 cards #5 and up become card #2 through card #
 $2 + \frac{(N-1)N}{2} + 1$

input: I, J, TPR, TPX, TZR, TZX
FORMAT (1X, 2I2, 4E12.0)

I&J - numbers of windings between which the test has been conducted
TPR, TPX - real and imaginary parts of the positive sequence test in p.u.

TZR, TZX - real and imaginary parts of the zero sequence test in p.u.

Class III data has to be terminated with a blank card.

Class IV

One card specifying the key (KZOUT) to determine whether the output impedance matrix is to be in p.u. or in ohms.

KZOUT

FORMAT (1X, I2)

If KZOUT is zero - output in p.u., otherwise impedance matrix is in ohms.

Class V

Exactly N+1 cards containing winding number, rated voltage of the winding, indicator of delta windings and the node names to be used by the program in punching the branch impedance cards.

J, INDD, VR(J), R(J), NA(I), NB(I), NA(I1), NB(I1), NA(I2), NB(I2)

FORMAT (1X, I2, 1X, I1, 1X, 2E12.0, 6A6)

J = winding number (delta windings should always have the highest numbers!)

INDD = 0 - for Y windings
1 - for Delta windings

VR(J) = rated voltage of winding J, rms

R(J) = dc resistance of winding J

NA(I), NB(I),... - node names for phases A,B&C of winding J.

Class V data has to be terminated with a blank card.

NT - key for either reading the magnetizing impedances (XPOZ, XZERO) of the windings or for using an approximation to calculate them.

FORMAT (1X, I2)

NT = 1 in the case when magnetizing impedances are known for each winding, otherwise it is assumed that XPOZ and XZERO is known only for the first winding.

Class VII

One or N cards containing values for magnetizing impedances in positive and zero sequence for the first (when NT=1) or all the windings.

XPOZ , XZERO

FORMAT (1X, 2E12.0)

Note that when XPOZ and XZERO are known for each winding they should be entered in order corresponding to the assigned number starting from the lowest numbered (see Class V data cards).

Class VII data has to be terminated with a blank card in this case.

3.0 Interpretation of Program's Output

The impedance matrix produced by the program is symmetrical and is represented by its lower triangular part only. This portion of the matrix is stored in one-dimensional array by using index transformation:

$K = J+I+(I-1)/2$, where I&J are indexes for row and column number of the matrix element and K - corresponding index for the same element of the matrix in the vector form. In general the transformer matrix is in the following form:

winding #1 _a	S ₁₁		
winding #2 _a	S ₁₂	S ₂₂	
.....	
winding #N _a	S _{IN}	S _{NN}
winding #1 _b	M ₁₁	M _{IN} S ₁₁
winding #2 _b	M ₁₂	M _{2N} S ₁₂ S ₂₂
.....
winding #N _b	M _{IN}	M _{NN} S _{IN}S _{NN}
winding #1 _c	M ₁₁	M _{IN} M ₁₁M _{IN} S ₁₁
winding #2 _c	M ₁₂	M _{2N} M ₁₂M _{2N} S ₁₂ S ₂₂
.....
winding #N _c	M _{IN}	M _{NN} M _{IN}M _{NN} S _{IN}S _{NN}

S_{ij} denotes coupling between windings I and J on one leg of the transformer and M_{ij} - between winding I on one leg and winding J on another leg.

55, LOWB , ,)	-0.733191019974E-01, -0.527320725720E+04 §
	0.000000000000E+00, -0.252774399980E+04 §
	-0.325054568924E-01, -0.509650587464E+03 ,,,,,
	-0.646793103319E-01, 0.107059927425E+05 §
	0.298750000000E-01, 0.514227199959E+04 ,,,,,
56, TERTB , TERT1B ,)	-0.494356580078E-01, -0.106342221589E+04 §
	-0.325054568924E-01, -0.509650587464E+03 §
	0.000000000000E+00, -0.102798080000E+03 ,,,,,
	-0.362556943697E-01, 0.215874652794E+04 §
	-0.357184214476E-01, 0.103714560936E+04 §
	0.112800000000E-01, 0.209767040000E+03 ,,,,,
57, HIGHC , ,)	0.000000000000E+00, -0.110000000004E+05 §
	-0.733191019974E-01, -0.527320725720E+04 §
	-0.494356580078E-01, -0.106342221589E+04 ,,,,,
	0.000000000000E+00, -0.110000000004E+05 §
	-0.733191019974E-01, -0.527320725720E+04 §
	-0.494356580078E-01, -0.106342221589E+04 ,,,,,
	0.473000000000E+00, 0.223333333341E+05 ,,,,,
58, LOWC , ,)	-0.733191019974E-01, -0.527320725720E+04 §
	0.000000000000E+00, -0.252774399980E+04 §
	-0.325054568924E-01, -0.509650587464E+03 ,,,,,
	-0.733191019974E-01, -0.527320725720E+04 §
	0.000000000000E+00, -0.252774399980E+04 §
	-0.325054568924E-01, -0.509650587464E+03 ,,,,,
	-0.646793103319E-01, 0.107059927425E+05 §
	0.298750000000E-01, 0.514227199959E+04 ,,,,,
59, TERT1C, TERT2 ,)	-0.494356580078E-01, -0.106342221589E+04 §
	-0.325054568924E-01, -0.509650587464E+03 §
	0.000000000000E+00, -0.102798080000E+03 ,,,,,
	-0.494356580078E-01, -0.106342221589E+04 §
	-0.325054568924E-01, -0.509650587464E+03 §
	0.000000000000E+00, -0.102798080000E+03 ,,,,,
	-0.362556943697E-01, 0.215874652794E+04 §
	-0.357184214476E-01, 0.103714560936E+04 §
	0.112800000000E-01, 0.209767040000E+03 ,,,,,

Closer look at input data:

BEGIN NEW DATA CASE
XFORMER

3 1	60.	750.0			
1 2	.0017	.13	.0057	.115	
1 3	.0042	.35	.0096	.268	
2 3	.0044	.2	.0143	.136	

BLANK CARD ENDING MEASUREMENTS.

1						
1 0	288.6751346	.473	HIGHA	HIGHB	HIGHC	card
2 0	138.5640646	.029875	LOWA	LOWB	LOWC	
3 1	28.	.01128	TERTA	TERT1A	TERT2B	TERT1B
			TERT1C	TERT2C	TERT1C	TERTA

BLANK CARD ENDING WINDINGS.

1		
100.0	1.	
99.87	1.13	
99.67	1.33	

BLANK CARD END MAGNETIZING IMPEDANCES.
BLANK CARD ENDING "TRELEG" DATA CASES.
BEGIN NEW DATA CASE

33.

Request for
"TRELEG" by
using "33."
punched in
cols. 38-40
of "XFORMER"

Section 7.1B

"BCTRAN" ---- a supporting program designed to generate [A],[B] branch cards for 3-phase, 3-leg, core-type transformers.

Background

For the representation of 3-phase transformers, the preceding "TRELEG" (Section 7.1A) by Vladimir was the first data generator to be added to the EMTP. But Hermann was simultaneously working on related code using [A],[B] matrices (see paragraph 2 of Section 7.1A). This code, a separate program in Vancouver, was given the name of "BCTRAN" when appended to the EMTP as a supporting program during December of 1980 ("M29." UTPF idents).

Access to "BCTRAN" is very similar to the illustrated procedure for "TRELEG"; the only difference is that a value of "44." is to be punched in columns 38-40, rather than "33." as for Vladimir. This is on the "XFORMER" request card (text in cols. 1-7).

Yet we warn all potential users that the "BCTRAN" code is quite untested, and that user instructions can not be located. During December of 1980, WSM merely added the code, making changes which were superficially believed to be necessary for universality. While there were good intentions of debugging, testing, and documenting the feature at that time, the project somehow slipped from the front burner of the stove to the back burner, and then the utility company turned off the gas. Our move from 1202 N.E. Holladay to the Lloyd Center Tower required the elimination of about half of our storage, and now even Hermann's original writeup can not be located. It now appears that testing and documentation will await the 10 May 1982 trip by Hermann to BPA, when he can bring another copy of his test materials. We do (I repeat, DO) intend to activate this feature, if only because of my inherent prejudice against singular matrices (all other things being equal, we would favor "BCTRAN" over "TRELEG"). So, any EMTP version with "M32." or later UTPF idents should have this modeling workable, while the status of "M29." through "M31." versions is unknown and untested. Sorry about this. 11 April 1982

P.S. --- If any advice about this code is required, contact Vancouver, not Portland! WSM.

***** LAST-MINUTE IMPROVEMENT BY THL *****

The status of "BCTRAN" code has changed for the better this week! Tsu-huei located Hermann's original documentation for the program (it was on loan to one of our production users), and just yesterday she was able to set up and run the illustrative sample problem. Our "M31." VAX EMTP answers agree with Hermann's printed results to the sixth decimal digit or so. Why agreement is not better is not known at this time, though the discrepancy seems to be of little engineering significance. The feature seems to be basically operational after all!

24 April 1982

To illustrate the EMTP-request for "BCTRAN", and also perhaps establish a modicum of reader confidence in the EMTP implementation, we shall here show Tsu-huei's data file in its entirety (note that it is being preserved for posterity as a standard EMTP test case, to be a part of "M32." and later verification materials):

```
BEGIN NEW DATA CASE
C   BENCHMARK   DCNEW-8
C   TEST OF "BCTRAN" 3-PHASE TRANSFORMER ROUTINE OF EMTP.   THIS
C   PARTICULAR TEST CASE IS FROM HERMANN'S ORIGINAL UBC WRITEUP.
C   456789012345678901234567890123456789012345678901234567890123456
XFORMER
      44.
360.      .428      300.      135.73      .428      300.      135.73      1
1132.79056 .2054666 H-1      H-2      H-3
263.393059 .0742333 L-1      L-2      L-3
350.      .0822      T-1      T-2      T-2      T-1
1 20.      8.74      300.      7.3431941 300.      3 1
1 30.      8.68      76.      26.258183 300.
2 30.      5.31      76.      18.552824 300.
BLANK CARD TO TERMINATE THE SHORT-CIRCUIT TEST DATA
BLANK CARD TO TERMINATE "XFORMER" DATA CASES
BEGIN NEW DATA CASE
BLANK CARD TERMINATING EMTP DATA CASES
```

For subsequent EMTP representation of the transformer of interest, contents of the LUNIT7 punch file are to be used. Temporarily (as received from Vancouver), these are EMTP branch cards of [R],[L] type, and they use the new high-precision format. That is, Type 51,52,... branch cards are involved, with 16-column wide numbers (see final page of Section 1.23, page 11b). The \$VINTAGE,1 option must be in effect for use of such cards. For Hermann's test case, our VAX LUNIT7 punch file begins as follows:

```
51H-1      0.2054666000E+00 0.4143209749E+05
52L-1      0.0000000000E+00 0.1977102763E+05
           0.7423330000E-01 0.9437879471E+04
53T-1      T-2      0.0000000000E+00 0.1557956789E+05
           0.0000000000E+00 0.7437550277E+04
           0.8220000000E-01 0.5866218159E+04
54H-2      0.0000000000E+00-0.5331063561E-01
           0.0000000000E+00 0.9559994360E+00
           0.0000000000E+00 0.1751763917E+01
           0.2054666000E+00 0.4143209749E+05
55L-2      0.0000000000E+00 0.9559994360E+00
           0.0000000000E+00 0.7376473976E+00
```

Etc.

The VAX numbers can be compared with Hermann's IBM numbers at the end of his writeup which follows.

None of Hermann's error stops have yet been converted to regular EMTP error stops (with KILL codes). Rather, they have been left with STOP statements local to overlay 41. Later, given more time,

The following pages of this section represent an unaltered (except for added Rule Book page numbers to the left or above the original UBC ones) appendage of Hermann's original user instructions. Only his appendix (Ref. 34, his 1975 PSCC paper on transformers) has been omitted for reasons of brevity. Hermann:

THREE-PHASE TRANSFORMER PROGRAM
USER'S MANUAL

THE UNIVERSITY OF BRITISH COLUMBIA
DEPARTMENT OF ELECTRICAL ENGINEERING
2356 MAIN MALL
VANCOUVER, B.C. CANADA
V6T 1W5

December 1980

The basic ideas for this program have evolved over many years. A major incentive for expanding the methods of appendix 1 from single-phase to three-phase transformers came from discussions at an EMTP Workshop at the University of Wisconsin, Madison, Wisconsin, in 1978, where Mr. M.M. Price and others convinced me of the need for such models.

I am indebted to Dr. V. Brandwajn of Ontario Hydro for testing an early version of this program and for frequent discussions, to Mr. T. Lou for making the modifications to account for closed deltas in zero sequence tests, and last but not least to my wife I.I. Dommel for doing a large part of the programming and documentation.

The financial assistance of Bonneville Power Administration in Portland, Oregon and of the System Engineering Division of B.C. Hydro and Power Authority in Vancouver, Canada, are gratefully acknowledged.

H.W. Dommel

December 1980

TABLE OF CONTENTS

	Page
1. BRIEF DESCRIPTION OF THE SOLUTION METHOD	1
1.1 [R]- and [L] ⁻¹ -matrices which reproduce short-circuit test data	1
1.2 Modification of zero sequence short-circuit test data in case of delta-connected windings	3
1.3 Addition of linear magnetizing impedances which reproduce excitation test data	4
1.4 [R]- and [L]-matrices which reproduce short-circuit and excitation test data	6
1.5 Single-phase transformers	6
1.6 Connections and phase shift	7
1.7 Autotransformers	7
1.8 Saturation effects	8
1.9 Exciting current in zero sequence excitation test	8
2. DATA DECK	10
3. DESCRIPTION OF THE DATA DECK	11
3.1 Excitation data	11
3.2 Winding data	12
3.3 Short-circuit test data	13
4. ERROR MESSAGES	16
5. DESCRIPTION OF THE OUTPUT	17
5.1 Shunt resistances for representation of excitation losses	17
5.2 Resistance and reactance (or inverse inductance) matrix	17
6. TEST EXAMPLE	18
REFERENCES	22
APPENDIX 1. Transformer Models in the Simulation of Electro-magnetic Transients	23

1. BRIEF DESCRIPTION OF THE SOLUTION METHOD

This Three-Phase Transformer Program produces models for three-phase and single-phase transformers in the form of resistance and reactance matrices from the test data supplied by the user. These matrices can be read directly as branch input data by the BPA/UBC Electromagnetic Transients Program. They represent the linear behaviour of the transformer with reasonable accuracy from dc up to moderate frequencies (maybe 1 kHz or so). Saturation and hysteresis effects can be modelled with additional branches, as explained in section 1.8, p.8. At higher frequencies, capacitances would have to be added, e.g., as described in [1].

Models for N-winding single-phase transformers have been well known for some time. Their derivation is described in appendix 1. N-winding three-phase transformers are somewhat more difficult to model. The solution on transient network analyzers has been the addition of an extra delta-connected winding to three-phase banks made up of single-phase transformers, to represent the magnetic coupling among the three cores. The three-phase transformer model described on p. 129 of [2] is presumably based on that idea. To relate the test data to the data of the added winding is not always easy, however. For example, a two-winding three-phase transformer would have to be modelled as three three-winding single-phase transformers, for which 3 reactances would be required. However, only 2 reactances would be available from the positive and zero sequence short-circuit tests. The procedures become even more complicated for three-winding three-phase transformers. It was therefore reasonable to look for a new technique, in which a two-winding three-phase transformer, for instance, is simply modelled as 6 coupled branches.

For a complete understanding of the following sections, it is necessary to refer to appendix 1, where most of the ideas are explained for single-phase transformers.

1.1 $[R]$ - and $[L]^{-1}$ -matrices which reproduce short-circuit test data

These matrices are found from the admittance matrix representation described in section 3 of appendix 1 for single-phase transformers. In the following, only the modifications required to get from single-phase to three-phase, and the separation of $[R]$ from $[L]^{-1}$, will be explained. The program follows roughly the procedures outlined below:

- (a) Specify the voltage ratings for each winding in kV (line-to-ground for wye-connections, line-to-line for delta-connections), as well as exciting current and excitation losses from the positive and zero sequence excitation tests. Also specify the winding resistances, if available. If they are not specified, they can be calculated from the load losses supplied with the short-circuit data if $N=2$ or 3 . Strictly speaking, the load losses are not only I^2R -losses, but contain stray losses as well; however, this is ignored. In the calculation of winding resistances from load losses, it is assumed that R_1 p.u. = R_2 p.u. for two-winding transformers. For three-winding transformers, there are 3 equations in 3 unknowns R_1 p.u., R_2 p.u., R_3 p.u. . For instance, the p.u. load losses in the short-circuit test between 1 and 3 are R_1 p.u. + R_3 p.u. . For trans-

formers with 4 or more windings (per phase), there is no easy way to find winding resistances from the load losses. Therefore, winding resistances must be specified as input data for $N > 4$.

- (b) Specify the $(N \cdot (N-1))/2$ short-circuit input impedances of the N -winding three-phase transformer, for the positive sequence test and for the zero sequence test, as well as the positive sequence load losses. The reactances are then calculated from

$$X_{ik \text{ p.u.}} = \sqrt{Z_{ik \text{ p.u.}}^2 - (R_i \text{ p.u.} + R_k \text{ p.u.})^2} \quad (1)$$

with $Z_{ik \text{ p.u.}}$ = p.u. short-circuit input impedance in test between i and k , converted to a 1 MVA basis (three-phase),
 $R_i \text{ p.u.} + R_k \text{ p.u.}$ = p.u. load losses on a 1 MVA basis if load losses are nonzero, or specified p.u. winding resistances on a 1 MVA basis if load losses are not given.

Equation (1) is used for positive sequence values, and for zero sequence values as well if the zero sequence test does not involve a third (delta-connected) winding. In the latter case, the procedure of section 1.2, p.3 is used.

- (c) Build the reduced matrix $[X^{\text{reduced}}]$ from the short-circuit input reactances as described in section 3 of appendix 1, except that the resistive part has been taken out and that the transformer is now three-phase rather than single-phase. The extension to three-phase transformers is very easy if each scalar X is simply replaced by a 3×3 submatrix of the form

$$\begin{bmatrix} X_s & X_m & X_m \\ X_m & X_s & X_m \\ X_m & X_m & X_s \end{bmatrix}$$

where X_s is the self reactance of each phase and X_m is the mutual reactance among the three phases. As in any other three-phase network component, these self and mutual reactances are related to the positive and zero sequence values X_1 and X_0 by

$$X_s = \frac{1}{3} (X_0 + 2X_1) \quad (2)$$

$$X_m = \frac{1}{3} (X_0 - X_1) \quad (3)$$

For instance, Eq. (9a) of appendix 1 states that the diagonal element Z_{ii}^{reduced} is equal to the short-circuit input impedance of the test between windings i and N . This scalar value is now simply replaced by a 3×3 submatrix with

$$X_s = \frac{1}{3} (X_0^{\text{short } i \text{ to } N} + 2X_1^{\text{short } i \text{ to } N})$$

$$X_m = \frac{1}{3} (X_0^{\text{short } i \text{ to } N} - X_1^{\text{short } i \text{ to } N})$$

Since the 3×3 submatrices contain only 2 distinct values X_s and X_m , it is not necessary to work with 3×3 matrices, but only with pairs (X_s, X_m) .

D. Hedman derived the special "balanced-matrix algebra" in [3], for the multiplication, inversion, etc., of such pairs.

- (d) Invert $[X^{\text{reduced}}]$ to get $[B^{\text{reduced}}]$ (which is the negative imaginary part of $[Y^{\text{reduced}}]$ in section 3 of appendix 1), again using Hedman's "balanced-matrix algebra", and then expand $[B^{\text{reduced}}]$ to the full matrix $[B]$ as explained in section 3 of appendix 1 (each element in the added row and column is again a 3x3 "balanced" submatrix). Since the reactances in procedure (b) were in p.u. on a 1 MVA basis, all the turn ratios w in section 3 of appendix 1 were 1.0. To convert the full $[B]$ -matrix to an $[L]^{-1}$ -matrix in physical units, each element i - k of $[B]$ is multiplied by the factor $\omega/(V_{\text{rating-}i} \cdot V_{\text{rating-}k})$, where $V_{\text{rating-}i}$ and $V_{\text{rating-}k}$ are the rated voltages of windings i and k , and ω is the rated angular frequency.

The BPA Electromagnetic Transients Program accepts this $[L]^{-1}$ -matrix directly, as described on p. 11 of [2]. Note that $[A]$ on p. 11 is $[L]^{-1}$ in $1/H$, independent of XOPT. It is also advisable to set $[L]^{-1} \cdot [R]$ equal to zero, because this matrix is generally not symmetric (an oversight when this "alternative performance equation for series segment of Π -circuit" was implemented). Add the resistances found in procedure (a) as extra branches, instead. The UBC Electromagnetic Transients Program does not accept $[L]^{-1}$ -matrices at this time; with this version, the transformer must be represented as an impedance matrix with nonzero exciting current, as described in section 1.3, p. 4.

1.2 Modification of zero-sequence short-circuit test data in case of delta-connected windings

The method described in section 1.1 does not work if a three-winding three-phase transformer has a delta-connected tertiary. Let us assume that the high-voltage and low-voltage windings are wye-connected with their neutral grounded. In this case, the zero-sequence short-circuit test between the high- and low-voltage windings will not only have the low-voltage winding shorted but the tertiary winding as well if the delta is closed (which is usually the case). This special situation is handled by modifying the data for an open delta so that the approach of section 1.1 can again be used. With the well-known equivalent star circuit of Fig. 1, the 3 test values supplied by the user are

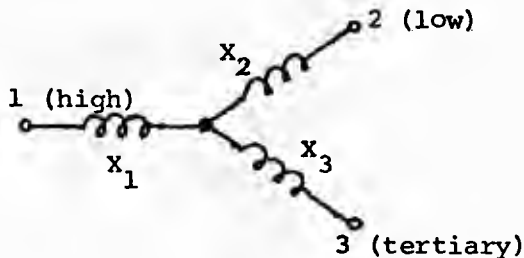

Fig. 1. Equivalent star circuit for zero-sequence short-circuit tests of a three-winding transformer (all reactances must be in p.u.)

$$X_{12}^{\text{closed } \Delta} = X_1 + \frac{X_2 X_3}{X_2 + X_3} \tag{4}$$

$$X_{13} = X_1 + X_3 \tag{5}$$

$$X_{23} = X_2 + X_3 \tag{6}$$

which can be solved for X_1, X_2, X_3 :

$$X_1 = X_{13} - \sqrt{X_{23}X_{13} - X_{12}^{\text{closed } \Delta} X_{23}} \quad (7)$$

$$X_2 = X_{23} - X_{13} + X_1 \quad (8)$$

$$X_3 = X_{13} - X_1 \quad (9)$$

After this modification, the program works with the short-circuit reactances $X_1 + X_2$, $X_1 + X_3$ and $X_2 + X_3$, which implies that 3 is no longer shorted in the test between 1 and 2. The modification scheme used in the program is more complicated because the resistances are also included in Eq. (4), which becomes

$$\left| Z_{12}^{\text{closed } \Delta} \right| = \left| R_1 + jX_1 + \frac{(R_2 + jX_2)(R_3 + jX_3)}{(R_2 + R_3) + j(X_2 + X_3)} \right| \quad (10)$$

with $\left| Z_{12}^{\text{closed } \Delta} \right|$ being the values supplied by the user, and R_1 , R_2 , R_3 being the winding resistances which were either directly supplied by the user or which were calculated from the load losses, as explained in procedure (a) of section 1.1, p. 1.

1.3 Addition of linear magnetizing impedances which reproduce excitation test data

The exciting current in 5-limb three-phase transformers and in single-phase transformers can often be ignored. If the exciting current is ignored, the $[L]^{-1}$ -matrix of section 1.1 is singular and cannot be inverted to a $[Z]$ -matrix. Since the UBC version of the Electromagnetic Transients Program can only accept $[Z]$ -matrices, users of that version must include a nonzero exciting current, if for no other reason than to make $[L]^{-1}$ nonsingular so that it can be inverted to produce a $[Z]$ -matrix, as described in section 1.4, p. 6.

For three-phase transformers with three-legged core construction, the exciting current in the zero sequence test is fairly high (e.g., 100%), and should no longer be ignored.

The shunt admittance of the magnetizing branch (Y_m in Fig. 5 of appendix 1), which is added to the $[R]$, $[L]^{-1}$ -model to represent the exciting current and excitation losses, is calculated from the excitation test data as described in section 4 of appendix 1, except that there are 2 sets of values now for the positive and zero sequence test. These 2 values are again converted to a 3x3 submatrix with diagonal elements Y_s and off-diagonal elements Y_m' ,

$$Y_s = \frac{1}{3} (Y_0 + 2Y_1) \quad (11)$$

$$Y_m = \frac{1}{3} (Y_0 - Y_1) \quad (12)$$

This shunt admittance matrix is then either connected across one winding (Eq. (18) in appendix 1), or $(1/N)$ -th of the p.u. values is connected across all N windings (Eq. (19) in appendix 1).

If shunt admittances are connected across all windings, as shown in Fig. 2,

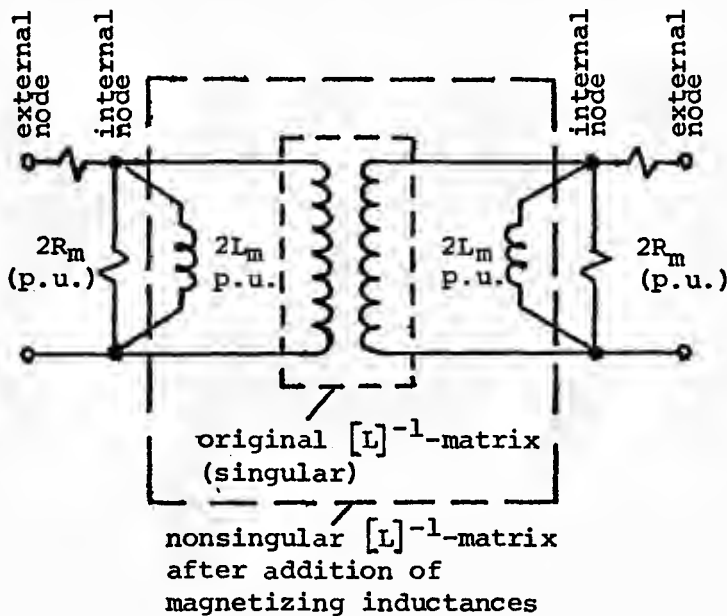

Fig. 2. Addition of magnetizing branches across all windings (shown for single-phase transformer with N=2)

then no correction is made by the program to account for the influence of the short-circuit input impedances. As a consequence, the exciting current in the model of Fig. 2 will be slightly larger than the specified value, and the short-circuit input impedance will be slightly smaller than the specified value. For an exciting current of 0.01 p.u. (or $Z_m = 100$ p.u.) and a short-circuit input impedance of 0.10 p.u., I expect these differences to be approximately 0.1%. Note that the imaginary parts of (Y_s, Y_m) become part of the $[L]^{-1}$ -matrix, as indicated by the large, dotted box in Fig. 2. This modification makes the $[L]^{-1}$ -matrix nonsingular and invertible, as further explained in section 1.4. The resistances R_m , which represent hysteresis and eddy current losses approximately, as

explained in section 6 of appendix 1, must be added as additional branches at the "internal nodes" (Fig. 2), which will be accessible anyhow if extra branches are used for the winding resistances, as recommended at the end of section 1.1 *) Adding R_m at the "external nodes" (Fig. 2), instead, is probably just as accurate, because in many studies R_m is left off entirely. The complete representation of a two-winding three-phase transformer with Dy-connection in the BPA Electromagnetic Transients Program would then look as follows (Fig. 3):

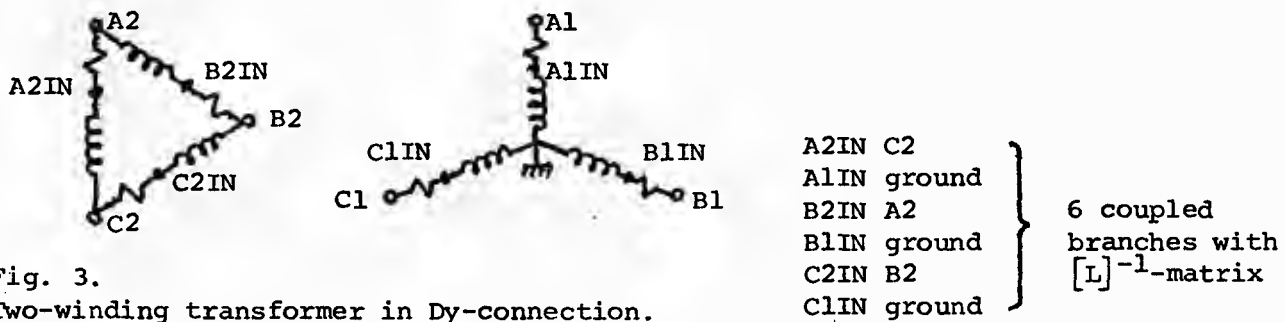

Fig. 3. Two-winding transformer in Dy-connection.

- | | | | |
|---------|--|-------------|---|
| A2 A2IN | } single-phase resistance branches (winding resistances) | A2IN C2 | } single-phase resistance branches with R_m -values |
| B2 B2IN | | B2IN A2 | |
| C2 C2IN | | C2IN B2 | |
| A1 A1IN | } single-phase resistance branches (winding resistances) | A1IN ground | |
| B1 B1IN | | B1IN ground | |
| C1 C1IN | | C1IN ground | |

*) Eventually, the "alternative performance equation for series segment of Π -circuit" in the BPA Electromagnetic Transients Program should be changed to accept $[R]$ - and $[L]^{-1}$ -matrices. When this is done, then it may be best to drop the "internal nodes" and connect the resistances R_m across the "external nodes".

If the resistances R_m are ignored, then the last 6 branches would be left off, and if winding resistances are ignored as well, then only the first 6 branch cards would be used.

If the shunt admittance matrix is connected across one winding only, then the program makes a correction in the case where the excitation test is made across one winding i while the shunt admittance matrix is connected across another winding k . In that case, the short-circuit input impedance between i and k is subtracted from the inverse of (Y_s, Y_m) , and this modified shunt admittance is then connected across k . This way, the specified excitation data and the excitation data obtainable from the model will be identical. If the user specifies zero excitation losses, they will be raised to the value $I_{exciting}^2 \cdot R_i$ in this case, because in reality these losses must be at least as high as the I^2R -losses in winding i . As explained in section 4 of appendix 1, it may be best to connect the shunt admittance across the winding closest to the core on transformers with cylindrical windings.

1.4 [R]- and [L]- matrices which reproduce short-circuit and excitation test data

The addition of magnetizing branches in section 1.3 makes $[L]^{-1}$ nonsingular. If this matrix is inverted, a $[R]$, $[L]$ - model of the transformer is obtained which will reproduce the short-circuit as well as the excitation test data with reasonable accuracy. The data of this model can easily be read by the BPA and UBC versions of the Electromagnetic Transients Program. If the resistances R_m are ignored, the two-winding transformer of Fig. 3 would have the following branches (read as a multiphase Π -circuit, with the capacitance values left blank):

from	to	
A2	C2	} 6 coupled branches with diagonal $[R]$ - matrix and full $[L]$ - matrix
A1	ground	
B2	A2	
B1	ground	
C2	B2	
C1	ground	

Note that the internal nodes are no longer needed because series $[R]$, $[L]$ -connections are directly accepted by the transients program. If the resistances R_m are to be included, it might be best to connect them to the "external nodes" in this case.

1.5 Single-phase transformers

The Three-Phase Transformer Program works for three-phase banks consisting of single-phase transformers as well. In this case, all zero sequence values are ignored (leave the fields simply blank), and all positive sequence values must be the values of the single-phase transformers. In printing the matrices, the program recognizes that the 9×9 matrix of a three-winding three-phase transformer changes into three separate 3×3 -matrices for the three three-winding single-phase transformers.

1.6 Connections and phase shift

The connections are automatically established through the proper assignment of node names to the branches, as shown in the example of Fig. 3. Assigning node names not only establishes the type of connection (wye or delta), but the phase shift as well. For instance, voltages and currents on the secondary side 1 in Fig. 3 lag 30° behind those on the primary side. With the IEC designation ^{*}), Fig. 3 is a Dy1 connection. If the names on the delta side were re-assigned as in Fig. 4, a Dy5 connection would be obtained.

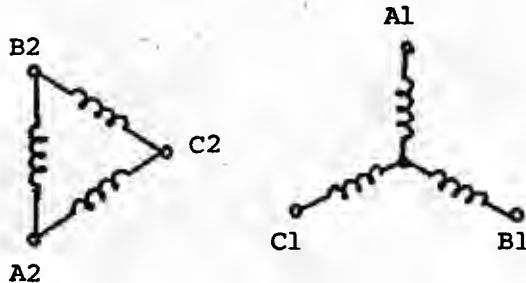

Fig. 4. Dy5 connection

Keep in mind that Yd1 and Dy1 are the preferred connections in North America. In many European countries, the preferred connections are Yd5 and Dy5.

Finally, keep in mind that a floating (open or closed) delta does not have its voltages to ground defined. If nothing is connected to such a delta, ground one corner!

1.7 Autotransformers

If the user treats an autotransformer the same way as a regular transformer (that is, if he only looks at the outside terminals and ignores the

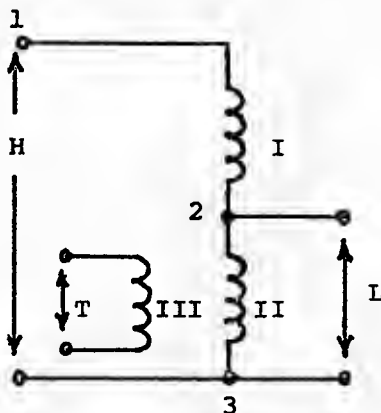

Fig. 5. Autotransformer

fact that two windings have a common section inside), he will probably get reasonably accurate results with the models produced by this program. It is possible, however, to develop more accurate models by modifying the short-circuit test data. In the case of Fig. 5, the short-circuit test data between H-L, H-T, L-T would have to be changed into short-circuit test data between I-II, I-III, II-III. The transformer would then simply be represented as 3 coupled windings I, II, III with winding I going from node 1 to 2 and winding II going from 2 to 3. I think I know how to make these modifications, but I have not implemented them in the program.

^{*}) The IEC designations are used here, which will appear in North American standards eventually (the new Canadian Transformer Standards refer to them already). In the IEC "clock system", the big hand is the voltage phasor (line-to-ground) of the high voltage winding which always points to 12 noon. The number 1 in Yd1 means that the small hand for the voltage phasor (line-to-ground) of the low voltage winding is at 1 o'clock (-30°). In Yd5 it is at 5 o'clock (-150°). Capital Y or D designates high voltage, lower case y or d low voltage. Y or y is wye connected, D or d is delta connected, and Z or z is zigzag connected.

1.8 Saturation effects

The inclusion of saturation effects is discussed in section 5 of appendix 1. Since the air-core inductance, which is the slope of the ψ/i -curve in the fully saturated region, is fairly low (typically twice the value of the short-circuit inductance [4]), it may make a difference where the nonlinear inductance is added. It is best to put the nonlinear inductance across the terminals of the winding closest to the core, which is usually the tertiary winding in three-winding transformers. Supporting evidence may be found in ref. 5 and 7 of appendix 1, as well as in [5].

1.9 Exciting current in zero sequence excitation test

If the transformer has delta-connected windings, it will be assumed that the delta connections are opened for the zero sequence excitation test (Fig. 9 on p. 11). Otherwise, the test is not really an excitation test, but a short-circuit test between the excited winding and the delta-connected windings, since closed delta connections provide a short-circuit path for zero sequence currents.

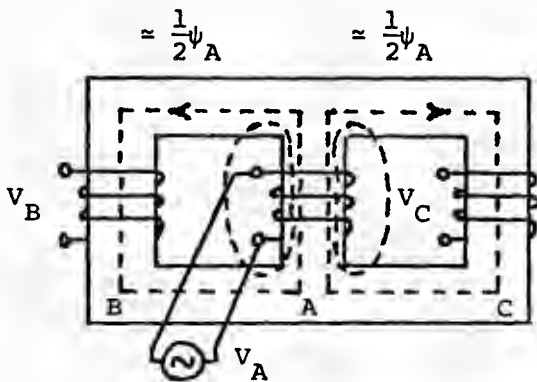

Fig. 6. Three-legged core-type design.

Often, the zero sequence exciting current is not given by the manufacturer. In such cases, a reasonable value can be found as follows: Excite one phase of a winding (A in Fig. 6), and estimate how much voltage will be induced in the other two phases (B and C in Fig. 6). For the three-legged core design of Fig. 6, almost one half of flux ψ_A returns through phases B and C, which means that V_B and V_C will be close to $0.5 V_A$ (with reversed polarity). If we use k for this factor, then

$$\frac{I_{\text{excit}}^{\text{zero}}}{I_{\text{excit}}^{\text{pos}}} = \frac{1 + k}{1 - 2k} \tag{13}$$

Eq. (13) is derived from

$$\begin{aligned} V_A &= Z_s I_A \\ V_B &= Z_m I_A \\ V_C &= Z_m I_A \end{aligned} \tag{14}$$

with Z_s = self impedance of phase A in excitation test, and Z_m = mutual impedance to phases B and C. Then

$$V_B = V_C = \frac{Z_m}{Z_s} V_A = - \frac{Z_{\text{pos}} - Z_{\text{zero}}}{2Z_{\text{pos}} + Z_{\text{zero}}} V_A = -k \cdot V_A \tag{15}$$

Since the exciting current is proportional to $1/Z_{pos}$ in positive sequence, and to $1/Z_{zero}$ in zero sequence, the relationship for k in Eq. (15) can be transformed into Eq. (13).

Obviously, k cannot be exactly 0.5, because this would lead to an infinite zero sequence exciting current. A reasonable value for I_{excit}^{zero} of a three-legged core-type design might be 100%. If $I_{excit}^{pos} = 0.5\%$, this would produce $k = 199/401 = 0.496$, which comes close to the theoretical limit of 0.5 mentioned above.

Besides the three-legged core-type design, there are also five-legged core-type designs (Fig. 7) and shell-type designs (Fig. 8). In the five-legged core-type design, maybe $2/3$ of approx. $(1/2)\psi_A$ returns through legs B and C. In that case, k would be $1/3$, or $I_{excit}^{zero}/I_{excit}^{pos} = 4$.

The excitation loss in the zero sequence test is higher than in the positive sequence test, because the fluxes ψ_A, ψ_B, ψ_C in the 3 cores are now equal and in the case of a three-legged core-type design, must return through air and the tank, with additional eddy-current losses in the tank.

Neither the value for the zero sequence excitation current nor the value for the zero sequence excitation loss are critical if the transformer has delta-connected windings because excitation tests really become short-circuit tests in such cases.

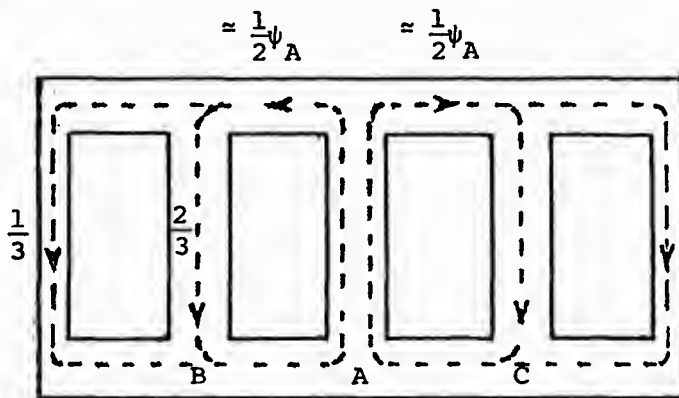

Fig. 7. Five-legged core-type design.

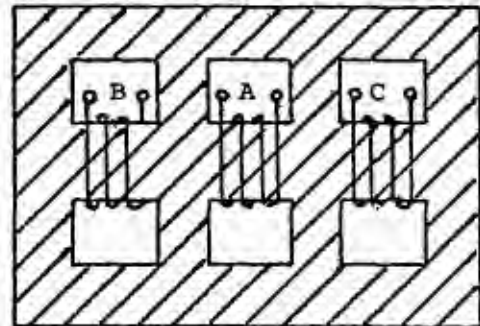

Fig. 8. Shell-type design.

2. DATA DECK

The data deck consists of

- (a) job control cards,
- (b) data decks for any number of transformers,
- (c) blank card to terminate data decks,
- (d) job termination card.

The data deck for each transformer consists of:

- (1) One card for excitation data.
- (2) Exactly N cards for winding data, one for each transformer winding.
- (3) Exactly $(N(N-1))/2$ cards for short-circuit test data, one for each short-circuit test between a pair of windings. Terminate the short-circuit test data with a blank card.

Note that there will be 2 blank cards at the end of the last transformer data deck: One to terminate the short-circuit test data, and one to terminate the run.

connected 230/500 kV three-phase transformer with a delta connected tertiary of 30 kV would have 3 windings (e.g., 1 = high voltage 500 kV, 2 = low voltage 230 kV, 3 = tertiary voltage 30 kV).

$V_{\text{rating-k}}$

Col. 4-13.

Rated voltage in kV; line-to-ground for wye-connected winding, line-to-line for delta connected winding.

In example: $V_1 = \frac{500}{\sqrt{3}}$ kV, $V_2 = \frac{230}{\sqrt{3}}$ kV, $V_3 = 30$ kV.

R_k

Col. 14-23.

Winding resistance in Ω of one phase (if the values differ in the three phases, use the average value). If the winding resistances are not known, they can be calculated from the load losses P_{ik} for $N \leq 3$, provided $P_{ik} > 0$ for all short-circuit tests (see also parameters P_{ik} and ILOSS of 3.3, and section 1.1, procedure (a), p. 1).

NAME 1 ...

Col. 25-30; 31-36; 37-42; 43-48; 49-54; 55-60.

NAME 6

Node names. The terminals of the winding in each one of the three phases have to be assigned node names to produce output data in the form of branch cards which can be used directly as input by the Electromagnetic Transients Program. Exactly 6 node names are required per winding (one pair for each one of the 3 phases). If a terminal is connected to ground (e.g., the neutral in wye connection), then use a blank field as the name for 'ground' (see test example, p. 19).

3.3 Short-circuit test data

Exactly $(N(N-1)/2)$ cards, one card for each short-circuit test between a pair of windings, terminated by a blank card. The cards can be read in arbitrary order. The card format is shown on the following page.

Parameters:

i, k

Col. 1-2 and 3-4.

Numbers of the pair of windings between which the short-circuit test is made.

P_{ik}

Col. 5-14.

Load losses in kW in the positive sequence test. If $P_{ik} > 0$, then this value is used in Eq.(1) of section 1.1, p. 2 to find the positive sequence reactance. P_{ik} can also be used to calculate winding resistances for $N \leq 3$, provided $P_{ik} > 0$ for all short-circuit tests (see parameter ILOSS, p. 15). Read-in winding resistances are then ignored.

Z_{ik}^{pos}

Col. 15-24.

Short-circuit input impedance in percent in the positive sequence test between windings i and k , based on $S_{\text{rating}}^{\text{pos}}$ (three-phase)

The program cannot handle Ddd-connections with IDELTA>0 (I wouldn't even know how zero sequence tests could be performed on such a transformer without opening the delta-connection).

For three-phase transformer banks consisting of single-phase transformers, input the single-phase data as positive sequence parameters and leave the fields for the zero sequence input parameters blank, including IDELTA.

ILOSS

Col. 57-58.

Specify ILOSS on the first short-circuit test data card.

- = 0 or blank: Read-in winding resistances will be used.
- > 0: Winding resistances will be calculated from load losses P_{ik} , provided $N \leq 3$ and $P_{ik} > 0$ for all short-circuit tests. Read-in winding resistances are then ignored.

4. ERROR MESSAGES

The following messages indicate fatal errors in the input data. In each case program execution will be terminated and no more input cards will be read from the data deck of this case or of any following cases.

(1) "NUMBER OF WINDINGS = 'n'"

Number of windings is either 1 or > 10. To re-dimension the program for more than 10 windings, see COMMENT statements in first 3 lines of program listing.

(2) "EITHER ITEST = 'i' OR IPUT = 'k' NOT PERMITTED"

A winding has been specified from which the excitation test has been made but no winding has been specified across which the magnetizing branch should be connected, or vice versa.

(3) "'i'k' WRONG WINDING NUMBERS"

Message refers to pairs of windings between which the short-circuit test was made, in the following cases:

- a. Both windings have the same number.
- b. Either one or both of the winding numbers are larger than N, the specified number of transformer windings.
- c. Data for this pair of windings has already been read in on a preceding card.

(4) "LOAD LOSSES OR WINDING RESISTANCES TOO LARGE 'i'k'"

If argument of square root in Eq.(1), section 1.1, p. 2 is negative.

(5) "ONLY 'n' SHORT-CIRCUIT TESTS SPECIFIED, BUT 'm' ARE NEEDED"

Not enough short-circuit test data have been read in.

(6) "IDELTA='idelta' WRONG IN SHORT-CIRCUIT TEST BETWEEN 'i' AND 'k'"

- a. IDELTA is either i or k (see section 3.3, p. 14).
- b. IDELTA > N, with N being the specified number of transformer windings.

(7) "MODIFICATION OF ZERO SEQUENCE SHORT-CIRCUIT TEST BETWEEN 'i' AND 'k' NOT POSSIBLE. ERROR CODE = 'm'"

This particular case cannot be handled by the present version of the program. If more information is needed, contact H.W. Dommel.

(8) "DIAGONAL ELEMENT IN ROW 'i' CLOSE TO ZERO"

Can either happen in the inversion process with Eq.(11) of appendix 1 (very unlikely), or with the inversion of Eq.(20b) of appendix 1 (possible if exciting current is very small).

(9) "P.U. EXCITATION LOSS LARGER THAN P.U. EXCITING CURRENT (EITHER IN POS. OR ZERO SEQUENCE)"

5. DESCRIPTION OF THE OUTPUT

Section 6 shows a sample output. The results consist of 2 parts:

5.1 Shunt resistances for representation of excitation losses

Depending upon parameters IPUT and ITEST on the excitation data card (section 3.1, p.11), the program will provide one of the following results with short explanations:

"SHUNT RESISTANCES FOR REPRESENTATION OF EXCITATION LOSSES:"

(a) "PLACE SHUNT RESISTANCE MATRIX ACROSS WINDING 'IPUT' WITH R(SELF/OHM) = '___' AND R(MUTUAL/OHM) = '___'"

(b) "PLACE SHUNT RESISTANCE MATRIX ACROSS ALL TERMINALS WITH THE FOLLOWING VALUES:"

"WINDING NO.	R(SELF/OHM)	R(MUTUAL/OHM)"
'___'	'___'	'___'
⋮	⋮	⋮

(c) "LEAVE OFF, BECAUSE SERIES RESISTANCES ALREADY PRODUCE LOSSES WHICH ARE GREATER THAN INPUT VALUES OF EXCITATION LOSSES."

5.2 Resistance and reactance (or inverse inductance) matrix

These matrices are printed, as well as written on file for direct input into the Transients Program (see parameter IPRINT, section 3.1, p.12). As an example, the impedance matrix for a 3-winding, 3-phase transformer would have the following general form (only lower triangular part of the symmetric matrix provided):

Z11] leg I
Z12	Z22								
Z13	Z23	Z33							
M11	M12	M13	Z11] leg II
M12	M22	M23	Z12	Z22					
M13	M23	M33	Z13	Z23	Z33				
M11	M12	M13	M11	M12	M13	Z11] leg III
M12	M22	M23	M12	M22	M23	Z12	Z22		
M13	M23	M33	M13	M23	M33	Z13	Z23	Z33	
└───┬───┘			└───┬───┘			└───┬───┘			
leg I			leg II			leg III			

Zik = coupling between windings on one leg (including self impedance Zii)

Mik = coupling between windings on different legs

6. TEST EXAMPLE

Pages 19-21 show the input data and the results of a test example. When these results (resistance and reactance matrix plus shunt resistance) were used to get steady-state solutions with the Transients Program, the transformer test data were reproduced with high accuracy, as shown in the table below:

		input data	simulation results
pos. sequence excitation test	exciting current (%)	0.428	0.4281 (in H-1) 0.4280 (in H-2) 0.4280 (in H-3)
	excitation loss (kW)	135.73	135.731
zero sequence excitation test *)	exciting current (%)	0.428	0.428 in all 3 phases
	excitation loss (kW)	135.73	135.731
short-circuit tests **)	Z_{12}^{pos} (%)	8.74	8.740
	Z_{13}^{pos} (%)	8.68	8.680
	Z_{23}^{pos} (%)	5.31	5.31
	Z_{12}^{zero} (%)	7.343194 ^{***)}	7.34318
	Z_{13}^{zero} (%)	26.258183 ^{***)}	26.25806
	Z_{23}^{zero} (%)	18.552824 ^{***)}	18.55284

*) With open delta.

**) With closed delta.

***) These values were calculated from R and X values which were given with 2 digits after the period.

1	360.	.420	300.	135.73	.428	300.	135.73	1 3 1
2	1132.	.79056	H-1	H-2	H-3			
3	263.	.393055	L-1	L-2	L-3			
4	350.	.0022	T-1	T-2	T-3			
5	1 20.	8.74	300.	7.3431941	300.			
6	1 30.	8.08	76.	26.258183	300.			
7	2 30.	5.31	76.	18.552824	300.			

LINE NUMBERS 1 THROUGH 9 ABOVE CONTAIN INPUT DATA FOR TRANSFORMER TEST EXAMPLE

123456789012345678901234567890123456789012345678901234567890

col.1 col.10 col.20 ...

3-WINDING TRANSFORMER. FREQ.= 60.00HZ

OUTPUT OPTION = 1

EXCITING CURRENT (PERCENT) RATING(MVA) EXCITATION LOSS(KW)

POS. SEQ. 0.42800 300.00 135.7300

ZERO SEQ. 0.42800 300.00 135.7300

WINDING NO. VOLTAGE(KV) R(Ω) X(Ω) FOR LEGS I, II, III

1 132.791 0.20547 H-1 H-2 H-3

2 63.393 0.07423 L-1 L-2 L-3

3 50.000 0.08220 T-1 T-2 T-3

EXCITATION TEST MADE FROM WINDING 1. MAGN. IMPEDANCE PLACED ACROSS WINDING 3

FROM	TO	LOAD LOSS(KW)	IMPEDANCE(PERCENT)	RATING(MVA)	IMPEDANCE(PERCENT)	RATING(MVA)	ZERO SEQUENCE	CLOSED DELTA
1	2	0.0	8.74000	300.00	7.34319	300.00	3	IN
1	3	0.0	4.64000	76.00	26.25818	300.00	0	0
2	3	0.0	5.31000	76.00	18.55232	300.00	0	0

100h-22

LOSS = 0

RESISTANCE MATRIX VALUES ARE THOSE WHICH WERE READ IN

ZERO SEQUENCE TEST DATA BETWEEN 1 AND 2 IS MODIFIED FOR OPEN DELTA IN 3 WITH DELTA CLOSED AGAIN, MODIFIED DATA PRODUCES Z = 0.734319E+01 PERCENT, WHICH SHOULD AGREE WITH INPUT VALUE.

SHUNT RESISTANCES FOR REPRESENTATION OF EXCITATION LOSSES:

PLACE SHUNT RESISTANCE MATRIX ACROSS WINDING 3 WITH R(Ω)/OHM= 0.551108E+05 AND R(MUTUAL/OHM)= 0.125360E+02

BRANCH DATA - RESISTANCE MATRIX (OHMS) AND REACTANCE MATRIX (OHMS) AT 60.00 HZ

51H-1 0.2054666001E+00 0.4143208073E+05

52L-1 0.0 0.1977101964E+05

53T-1 T-2 0.7423330004E-01 0.9437875653E+04

0.0 0.1557956158E+05

0.0 0.7437547267E+04

0.8220000005E-01 0.5866215786E+04

0.0 -0.5417520230E-01

0.0 0.9555865441E+00

0.0 0.1754430324E+01

0.2054666001E+00 0.4143208073E+05

0.0 0.9555865441E+00

0.0 0.7374502122E+00

0.0 0.8361213722E+00

0.0 0.1977101964E+05

0.7423330004E-01 0.9437875653E+04

0.0 0.1754430324E+01

0.0 0.8361213722E+00

0.0 0.6594739371E+00

0.0 0.1557956158E+05

0.0 0.7437547267E+04

0.8220000005E-01 0.5866215786E+04

0.0 -0.5417520230E-01

0.0 0.9555865441E+00

0.0 0.1754430324E+01

0.2054666001E+00 0.4143208073E+05

0.0 0.9555865441E+00

0.0 0.7374502122E+00

0.0 0.8361213722E+00

0.0 0.9555865441E+00

0.0 0.7374502122E+00

0.0 0.8361213722E+00

REFERENCES

- 1 R.C. Degeneff, "A method for constructing terminal models for single-phase n-winding transformers," Paper A 78 539-9, presented at IEEE PES Summer Meeting, Los Angeles, Calif., July 16-21, 1978.
- 2 Electromagnetic Transients Program User Manual (Nov. 77), or Reference Manual (May 80), or Rule Book (Sept. 80), p. 12g. Bonneville Power Administration, Portland, Oregon.
- 3 D.E. Hedman, "Theoretical evaluation of multiphase propagation," IEEE Trans. Power App. Syst., vol. 90, pp. 2460-2471, Nov./Dec. 1971.
- 4 D. Povh and W. Schulz, "Analysis of overvoltages caused by transformer magnetizing inrush current", IEEE Trans. Power App. Syst., vol. PAS-97, pp. 1355-1365, July/August 1978.
- 5 E.P. Dick and W. Watson, "Transformer models for transient studies based on field measurements", Paper presented at IEEE PES Winter Meeting, New York, N.Y., Febr. 3-8, 1980 (should appear soon in Trans. Power App. Syst.).

CONVERT ---- A supporting program designed to convert
rms v-i saturation curves into peak ψ -i curves

PURPOSE

Specification for nonlinear inductors requires a flux-current (ψ -i) saturation curve as per Section 1.33 of the User's Manual for the Transients Program. Yet typical test data consists of rms voltage and current readings corresponding to the configuration shown. With impressed sinusoidal voltage, an rms reading of the non-sinusoidal current into the winding is obtained. Program CONVERT is designed to convert from the user's rms v-i curve to the ψ -i curve needed by the Transients Program.

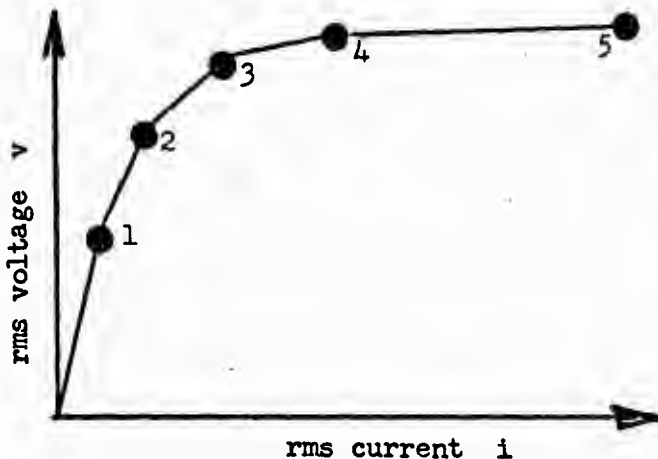
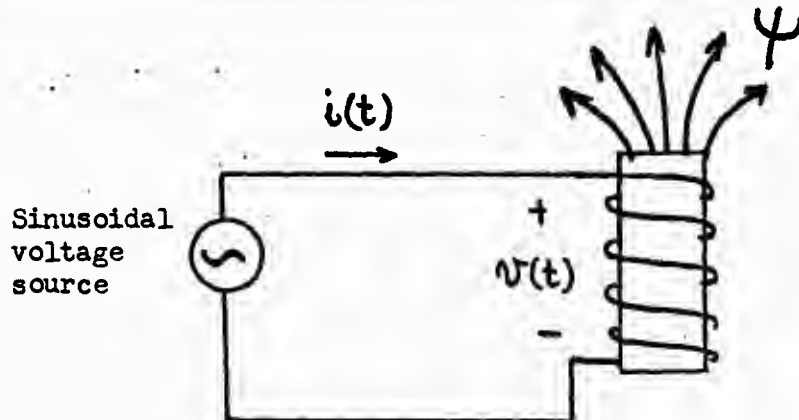
ASSUMPTIONS

The user inputs his v-i curve as a sequence of points, with linear interpolation between these values assumed. The output ψ -i curve is likewise piecewise-linear with the same number of points; it is exact, except for approximations:

1. The use of linear interpolation between points.
2. The use of finite-difference approximation to sinusoidal excitation. One-degree step-size is used, along with trapezoidal-rule integration where needed.
3. Hysteresis is ignored.

INPUT DATA FORMAT

Each case to be run consists of a miscellaneous-data card, followed by cards which supply the (I_{rms}, V_{rms}) break-points, followed by a 9999-card. A blank card should be placed after the last such data case, to end execution of program CONVERT.

1	2	3	4	5	6	7	8	9	10	11	12	13	14	15	16	17	18	19	20	21	22	23	24	25	26	27	28	29	30	31	32	33	34	35	36	37	38	39	40
FREQ								VBASE								PBASE								IPUNCH								KTHIRD							
E8.0								E8.0								E8.0								I8								I8							

FREQ ——— Frequency of the sinusoidal excitation, in Hz.

VBASE ——— Base voltage in kV , on which the input points are based.

PBASE ——— Base power in MVA , on which the input points are based.

IPUNCH ——— Parameter controlling the punched-card output of the derived flux-current curve:

$$\left\{ \begin{array}{l} 0 \Rightarrow \text{Yes, the curve will be punched.} \\ 1 \Rightarrow \text{No punched output.} \end{array} \right.$$

The cards are punched one point per card, using a 2E16.8 format.

KTHIRD ——— Zero or blank field will produce only first-quadrant output; unity will produce both the third and first quadrant points (the full curve).

The (I_{rms}, V_{rms}) points are next ——— one per card as per the format below, starting with the point closest to the origin and then moving continuously away. The curve must be single valued, with not over 100 points. No point $(0, 0)$ for the origin should be inputted. Values are in per unit on the previously-specified base, where

$$I_{base} = P_{base} / V_{base} \quad I_{rms} [\text{p.u.}] = I_{rms} [\text{amps}] / I_{base} [\text{amps}]$$

$$V_{rms} [\text{p.u.}] = V_{rms} [\text{kV}] / V_{base} [\text{kV}]$$

Terminate with a 9999-card.

1	2	3	4	5	6	7	8	9	10	11	12	13	14	15	16	17	18	19	20	21	22	23	24	25	26	27	28	29	30	31	32
I _{rms} [P.U.]																V _{rms} [P.U.]															
E16.0																E16.0															

1	2	3	4	5	6	7	8	9	10	11	12	13	14	15	16
															9999

Alternate Input of Incremental Inductance vs. Current Characteristic

Instead of an rms I-V characteristic, the user has the option of inputting a current vs. incremental inductance characteristic. Trapezoidal rule of integration is then used in this case, to convert the inductance curve into the desired output curve of flux vs. current:

$$\psi(i) = \int_0^i L(z) dz \quad \psi_1 = 0$$

$$\psi_k = \psi_{k-1} + \left\{ \frac{L_k + L_{k-1}}{2} \right\} \cdot (i_k - i_{k-1}) \quad k=2, 3, \dots$$

In order to use this special inductance-input option, the following modification of preceding rules must be observed:

1. Punch the field "FREQ" of columns 1-8 equal to -1.0 . This is the special request flag for inductance-input.
2. Leave fields "VBASE" (cols. 9-16) and "PBASE" (columns 17-24) blank or punched with zero if the supplied characteristic will be in units of amps and henries . Nonzero values are taken to be scaling factors by which the user's breakpoint values are to be multiplied in order to produce amps and henries :

VBASE = multiplying factor for input current coordinates;
 PBASE = multiplying factor for input inductance coordinates.

3. The current vs. incremental inductance characteristic is to be punched in columns 1-32 as per the following format, terminated by a 9999-card:

1	2	3	4	5	6	7	8	9	10	11	12	13	14	15	16	17	18	19	20	21	22	23	24	25	26	27	28	29	30	31	32	

1	2	3	4	5	6	7	8	9	10	11	12	13	14	15	16	17	18	19	20	21	22	23	24	25	26	27	28	29	30	31	32	

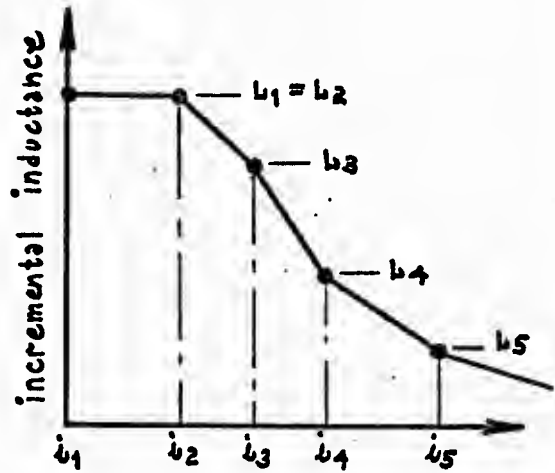

4. The current breakpoints i_k must be monotone increasing, starting with value zero. Incremental inductance values $L_k = d\psi/di$ at current value $i = i_k$ must all be positive. There also must be two or more points defining the characteristic.
5. Variable "IPUNCH" controls punched-card output. It might be mentioned that the (0.0, 0.0) point of the derived $i-\psi$ curve is printed, but is not punched. This is because usage with type-98 pseudo-nonlinear reactors (Section 1.29) and saturable transformers (Section 1.25) requires that the origin-point be omitted.

SAMPLE PROBLEM

The data listing at the right shows card images associated with the first two of several conversion cases which were run at the same time using Program CONVERT. Resulting EMTF line-printer output is displayed on the following page.

SATURATION			
-1.	10.	.001	1
	0.0		5.0
	2.0		5.0
	3.0		3.5
	4.0		2.0
	5.0		1.0
	10.0		1.0
	9999		
60.	.654	.01	1
	1.0		100.
	1.6		105.
	2.75		110.
	4.0		113.
	6.0		116.
	10.		119.
	44.		131.
	9999		
-1.	10.	.001	1

• Etc.

DATE 1M4020YV1 AND TIME OF DAY (HH-MM-SS) = 12/05/75 11.07.43 ANY PLOTS BEAR SAME FIGURES. ELECTROMAGNETIC TRANSIENTS PROGRAM OF THE BONNEVILLE POWER ADMINISTRATION, PORTLAND, OREGON. IF IN DOUBT AS TO WHAT THE FOLLOWING PRINTOUT MEANS, CONSULT THE 150-PAGE USER'S MANUAL. INDEPENDENT LIST LIMITS FOLLOW. TOTAL LENGTH OF /LABEL/ EQUALS 17307 INTEGER WORDS.

250 300 500 100 1500 40 500 1750 75 55 51 50 5 403 50 3 2 5

DESCRIPTIVE INTERPRETATION OF NEW-CASE INPUT DATA | INPUT DATA CIRC IMAGES PRINTED BELOW, ALL 80 COLUMNS, CHARACTER BY CHARACTER.

HARZER CARD PRECEEDING NEW DATA CASE.

COMMENT CARD.

COMMENT CARD.

COMMENT CARD.

REQUEST FOR MAGNETIC-SATURATION ROUTINE.

MISC. CONST. -.100E+01 .100E+02 .100E-02 .100E-01
(I, L) POINT. 0 .50000E+01
(I, L) POINT. .20000E+01 .50000E+01
(I, L) POINT. .30000E+01 .35000E+01
(I, L) POINT. .40000E+01 .20000E+01
(I, L) POINT. .50000E+01 .10000E+01
(I, L) POINT. .10000E+02 .10000E+01
SPECIAL TERMINATION-OF-POINTS CARD.

DERIVED SATURATION CURVE GIVING PEAK CURRENT VS. FLUX
ROW CURRENT (A) FLUX (VOIT-SEC)

REMEMBER. THE JUST-COMPLETED CONVERSION BEGAN WITH "CURRENT VS. INCREMENTAL INDUCTANCE CHARACTERISTIC, DUE TO MISCELLANEOUS DATA PARAMETER "FREQ" OF COLUMNS 1-8 BEING PUNCHED WITH A VALUE OF -1.0. TRAPEZOIDAL RULE INTEGRATION OF THE INDUCTANCE CURVE WAS USED, TO PRODUCE FLUX.

1 .000000000000
2 20.0000000000
3 30.0000000000
4 40.0000000000
5 50.0000000000
6 100.0000000000
MISC. CONST. .600E+02 .664E+00 .100E-01
(I, V) POINT. .1000E+01 .1000E+03
(I, V) POINT. .1600E+01 .1050E+03
(I, V) POINT. .2750E+01 .1100E+03
(I, V) POINT. .4000E+01 .1130E+03
(I, V) POINT. .6000E+01 .1160E+03
(I, V) POINT. .1000E+02 .1190E+03
(I, V) POINT. .4400E+02 .1210E+03
SPECIAL TERMINATION-OF-POINTS CARD.

DERIVED SATURATION CURVE GIVING PEAK CURRENT VS. FLUX
ROW CURRENT (AMP) FLUX (VOIT-SEC)

1 .0000000000
2 21.2933970237
3 57.242612031
4 99.8053477329
5 154.6164576772
6 236.9020266049
7 423.7672713234
8 1601.6892070497
MISC. CONST. .0000000000
(I, V) POINT. 249.087511368
(I, V) POINT. 261.5411818476
(I, V) POINT. 273.9981655505
(I, V) POINT. 281.4681939746
(I, V) POINT. 288.9415163967
(I, V) POINT. 296.41418228
(I, V) POINT. 326.3041435192

CHECK OF DERIVED CURVE 9V INDEPENDENT REVERSE COMPUTATION. ASSUMING SINUSOIDAL VOLTAGE (FLUX) AT LEVEL OF EACH POINT. RMS CURRENT IS FOUND NUMERICALLY. THIS CURVE SHOULD BE EQUAL TO THE ORIGINAL I-V POINTS INPUTTED.

ROW CURRENT IN P.U. VOLTAGE IN P.U.
2 1.00000000
3 1.60000000
4 2.75000000
5 4.00000000
6 6.00000000
7 10.00000000
8 44.00000000
MISC. CONST. -.100E+01 .100E+02 .100E-02
(I, L) POINT. .2000E+01 .5000E+01

No punched-card output

Case 1

Input bk are taken as being in mH

L vs. i

input

Case 2
V vs. I

input

Etc.

Section 7.2A

HYSDAT -- A supporting routine designed to provide the hysteresis loop required by a type-96 element given the type of core material and the saturation values of flux and current.

Purpose

Required input data for a type-96 hysteretic inductor includes the major loop characteristic specified in terms of flux and current ($\psi-i$). (See Section 1.30a). However it is anticipated that such transformer data, often times, will not be available, therefore an attempt will be made here to catalogue the hysteresis characteristics for several common core materials.

Input Data Format

This support routine is requested as follows: on the first card the keyword "SATURATION" is punched beginning in column one; the next card has the value 88. in the FREQ field. The next two cards then specify the necessary input data.

KEYWORD		
SATURATION		
FREQ		
E8.0		
ITYPE	LEVEL	IPUNCH
I8	I8	I8
CURSAT	FLXSAT	
E8.0	E8.0	

ITYPE -- This is used to specify the type of material as follows:

ITYPE = 1 is Armco M4 oriented silicon steel

LEVEL -- Level of accuracy desired (1, 2, 3, or 4).

The level of accuracy is specified by the number of points used to define the loop. The specific number of points in each level may vary from material to material but the following values are given as a rough idea:

<u>LEVEL</u>	<u># of points</u>
1	4-5
2	10
3	15
4	20-25

Unless space or time constraints should prove to be important, level 3 or 4 is suggested.

IPUNCH -- Parameter controlling the punched-card output of the derived flux-current loop:

0 Yes, the curve will be punched

1 No punched output

The cards are punched one point per card, using a 2E16.7 format.

CURSAT -- The current coordinate of the positive saturation point for the actual reactor being specified, (i.e. the point in the 1st quadrant of the flux-current plane where the hysteresis loop changes from being multivalued to singlevalued).

FLXSAT -- The flux coordinate of the positive saturation point for the actual reactor being specified.

Recall that the shape of the hysteresis loop for an inductor depends primarily on the material of the core, while the scaling of the hysteresis loop depends on geometry, the number of turns, and other factors of the actual construction. What is stored in this routine is essentially the shape of the loop for the material specified. It is necessary for the user to provide the information for the actual reactor being specified, which will allow the correct scaling to be performed. This is the purpose of variables CURSAT and FLXSAT.

One suggested way of determining values for CURSAT and FLXSAT from normal or dc magnetization curves (which seem to be more readily available than hysteresis loop curves) is as follows: beginning at the right of the normal magnetization curve, in its linear region, a straight-edge is used to extrapolate this line back to the left; the point where this straight line and the actual curve first begin to diverge is then taken as the saturation point.

Finally a caution seems in order. When determining the saturation point, care should be taken to determine it accurately since any error in determining CURSAT will cause a corresponding error in the width of the loop. For example, if the value of CURSAT was chosen to be a factor of ten too small (which might easily happen if one failed to notice a change of scale, for instance) the width of the loop at flux = 0 would also be a factor of ten too small. This is a fairly drastic error near zero flux, but quite possibly a relatively small error near the saturation region.

At this point, if it is desired to determine the hysteresis loop for a new hysteretic reactor, the user should specify new values for ITYPE, LEVEL, IPUNCH, CURSAT, and FLXSAT. A blank card will terminate hysteresis-curve requests. A second blank card is necessary to terminate all SATURATION cases and a third blank card terminates a nonexistent following data case.

Section 7.2b

ARRDAT ----- A supporting routine designed to generate EMTP data parameters needed for the Section 1.32 modeling of multiphase ZnO surge arresters.

0. Overview; Access to Supporting Routine

Though in no way related to magnetic saturation, this little supporting program has been appended to the "SATURATION" overlay (number 42) for reasons of convenience. The original code and user instructions were written by Dr. Vladimir Brandwajn of Ontario Hydro, supplied to BPA on cards as a self contained program during April of 1980. The code was substantially modified in November, 1983. The user instructions which follow below correspond to the state of the code as of January, 1984.

Application is to the multi phase ZnO modeling of Section 1.32 . there also is some applicability to SiC arresters, though dynamics of the gap will not be represented (unlike in Section 1.34). In summary, "ARRDAT" accepts manufacturer's data for the arrester as input, and calculates parameters that are required for the EMTP data cards of Section 1.32 (which are used to represent such arresters in EMTP simulations).

Access to "ARRDAT" is simple. Begin with a data card bearing the key word "SATURATION". Follow this with a second card having the request number $FREQ = 77.0$ (read as E8.0). See sketch at right. Control is then transferred to "ARRDAT", which reads further data as described by Vladimir.

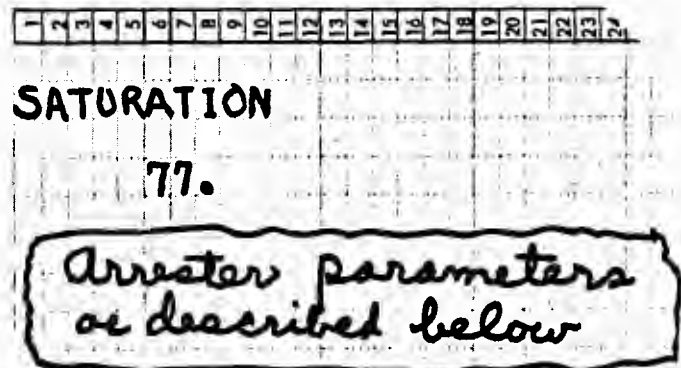

1. General

This program provides for a fit of exponential curves to a set of data points. The fitting is performed in the log-log plane using the least squares approach. There are two options for the determination of number of exponential segments to be fitted:

- (1) The user specifies the number and the boundaries of the segments. This older option was available as of April, 1980.
- (2) The program determines the number of segments depending on the maximum permissible relative error specified by the user. This newer option was first implemented in November, 1983.

2. Format of Data Cards

2.0 Optional "BRANCH" cards

An optional "BRANCH" card allows the user to produce EMTP branch cards with the terminal node names correctly punched in columns 3-14. The format is identical to that used for transmission lines ("JMARTI SETUP", etc.). As shown on p.202, the user punches the request word "BRANCH" in columns 1-6, and follows this with 2A6 terminal pair names beginning in column 9.

2.1 Card #1

NEXP	IPHASE	ERRLIM	IPRZNO	VREF	VFLASH
I12	I12	E12.0	I12	E12.0	E12.0

NEXP ---- Flag indicating which of the two fitting options is requested.
(1-12)

NEXP { < 0: Request for automatic determination of the number of segments.
= N: Request for user-supplied number of segments as well as their boundaries. The positive integer N defines the number of segments to be fitted.

IPHASE --- Number of phases of the multiphase compensation to be used in the EMT. This number affects only the printed and punched output of the program. If left unspecified, a default value of "1" will be assigned automatically by the program.
(13-24)

ERRLIM --- Maximum relative error permitted during the automatic determination of the number of segments (NEXP < 0). The default value of ERRLIM is 0.05, and it is defined as:

$$\text{ERROR} = \frac{\text{ABS} (C1 - C2)}{C1}$$

where C1 is value of the current as specified by the user, and C2 is value of the current as calculated by the program using the fitted characteristic.

IPRZNO ---- Control of diagnostic printout. Suggested values 0 to 3.
(37-48) Amount of printout increases with the assigned values.

VREF ---- Reference voltage used to scale the voltage data points. The scaling is used to prevent a possible overflow during the simulation of the EMT. The default value of VREF is taken to be twice of A2 on the card #2 below.
(49-60)

VFLASH --- Gap flashover (sparkover) voltage in Volts (crest). Leave this field blank or punch with zero if the arrester is gapless.
(61-72)

2.2 Card #2

A1	A2	A3	A4	A5	AMIN
E12.0	E12.0	E12.0	E12.0	E12.0	E12.0

A1 ---- Voltage rating of the arrester upon which the input data are based in volts rms.
(1-12)

A2 ---- The desired voltage rating of the arrester in volts rms. This variable can be used to:
(13-26) a) convert the arrester input data (voltages) from p.u. to V (volts);
b) obtain the characteristic of an electrically similar arrester with a different voltage rating. The properties of similar arresters do not change with rating, providing a proportional number of blocks is used to obtain the new rating.

- c) If VREF is maintained proportional to A2, similar arresters will have identical parameters at all ratings.

A3-----Multiplier used in the additional scaling of voltage points. It can be, for example, used to obtain a minimum characteristic (maximum energy) from a maximum characteristic (maximum voltage). The value to be normally used is 1.0.

A4-----Current multiplier used in obtaining characteristics of arresters with # of columns different from that for which the data points are known. An even current distribution is assumed.

A5 --- Flag signalling the existence (or its lack) of additional data describing the arrester after gap sparkover.

This parameter permits the representation of:

- arresters with shunt passive gaps. The shunted portion of the arrester can be of similar or dissimilar material;
- arresters with series passive gap. Before gap sparkover, the arrester is inoperative. Therefore, this data specifies the actual nonlinear material characteristic.

The user is to choose among the following options:

A5 {

- = 0.0 or 1.0 indicates a gapless arrester (no data follows);
- < 0.0 indicates that additional data follows, to represent dissimilar material for a shunt or a series gap;
- > 0.0 indicates that there is no further data. Instead, the original input data are to be used after multiplication of the voltages by A5.
- ≠ 1.0

AMIN---Minimum value of current above which segment #1 of the arrester characteristic begins. Even if fitting a straight line passing through the origin, do not leave AMIN blank (zero), log 0.0 is not defined;

2.3 Cards Specifying Arrester Characteristic

These cards come in NEXP (see card #1) groups, each terminated by a blank card. For the option of automatic determination of the number of segments (NEXP < 0), there is only one group of data.

A	B
E12.0	E12.0

A----Value of current (on the arrester characteristic) corresponding to:

B----Value of the voltage

103 k

The following two groups of data cards are present if and only if the parameter A5 on the data card #2 was less than zero (i.e., $A5 < 0$), and VFLASH on the card #1 was greater than zero.

2.4 Card #1

NEXP
I12

NEXP --- Number of exponential segments to be fitted. The user can, at this point, either preserve or change the fitting option, i.e., it is possible to fit the first part with $NEXP < 0$, and the second (after gap sparkover) part with $NEXP > 0$ or vice versa.

All the other constants are assumed to be as those specified on cards #1 and #2.

2.5 Cards specifying the Arrester Characteristic

These cards are of the same form as those described in Section 2 3 .

2.6 Termination of data cases

The user can execute a number of data cases by providing additional data sequences as specified in Sections 2.1 2.5 . Each new case follows immediately the blank card terminating the data for the last segment of the previous case. Two blank cards are needed to terminate the execution. The first one terminates ARR DAT, while the second one terminates SATURATION.

3.0 Examples

Consider a single-column ZnO arrester. The voltage points are known for an arrester rated 1 kv (crest), maximum voltage characteristic. The current points are given in A (crest). It is desired to obtain parameters for a 192 kv (rms), 3-column arrester with a maximum energy characteristic. The conversion factor to this characteristic is assumed to be .962 . The arrester is equipped with a shunt gap and the shunted part is electrically similar to the rest of the arrester. The shunt gap consists of 12% additional blocks, i.e., after gap sparkover the arrester contains .89286 ($1.0/1.12=.89286$) of the original blocks, and therefore $A5 = .89286$. A reference voltage 412500 V was chosen for the expected operating range of the 3-phase arrester. The arrester is equipped with a shunt gap which sparks over at 380000.0 V (crest).

3.1 Single-Exponent Fit (NEXP=1)

According to the data provided above, the following values are assigned to variables A1-A5:

A1 = $1000./\text{SQRT}(2)$ the original rating of the arrester in V (rms),
A2 = 192000. the required rating in V (rms),
A3 = .962 scaling factor for obtaining the desired maximum energy characteristic.
A4 = 3. the original data are given for a single-column arrester. Factor of 3.0 is needed to obtain the characteristic of a 3-column arrester.

A5 = .89286 the arrester, before sparkover, contains 12%
additional blocks.

A standard choice of AMIN is .001A, i.e., somewhere at the end
of the leakage current region.

3.2 Double Exponential Fit (NEXP = 2)

The characteristic described above is now to be fitted with two
exponentials. The border between the two segments has been determined
graphically on a log-log paper to lie between 100A and 200A.

All other parameters on cards #1 and #2 remain unchanged.

3.3 Automatic Segment Determination (NEXP = -1)

The same data will now be fitted with relative current error of 0.05,
i.e., ERRLIM = 0.05 .

3.4 Sample EMTP Input Data, Punched, and Printed Output

Current program input and output listings of the above three cases
are shown below. The input listings are shown first:

```
BEGIN NEW DATA CASE
C   BENCHMARK DC-39
SATURATION
77.
```

BRANCH	RECA	RECB	RECC			
	1	3	2		412500.	380000.
707.	107	192000.	.962	3.0	.892857	.001
	1.0	1164.8				
	2.0	1181.6				
	5.0	1198.4				
	10.	1209.6				
	20.	1232.0				
	50.	1260.0				
	100.	1288.0				
	200.	1323.84				
	500.	1388.8				
	1000.	1442.56				
	2000.	1512.0				
	3000.	1556.8				

BLANK CARD ENDING CHARACTERISTIC

BRANCH	RECA	RECB	RECC			
	2	3		1	412500.	380000.
707.	107	192000.	.962	3.0	.892857	.001
	1.0	1164.8				
	2.0	1181.6				
	5.0	1198.4				
	10.	1209.6				
	20.	1232.0				
	50.	1260.0				
	100.	1288.0				

BLANK CARD ENDING CHARACTERISTIC

103 m

C SHOWN BELOW IS AN EXAMPLE OF AUTOMATIC SEGMENT SELCTION USING
C AN UPGRADED FITTING PROCEDURE AVAILABLE AS OF "M38" VRESION.

BRANCH	RECA	RECB	RECC			
	-1	3	.05	1	412500.	380000.
707.	107	192000.	.962	3.0	.892857	.001
	1.0	1164.8				
	2.0	1181.6				
	5.0	1198.4				
	10.	1209.6				
	20.	1232.0				
	50.	1260.0				
	100.	1288.0				
	200.	1323.84				
	500.	1388.8				
	1000.	1442.56				
	2000.	1512.0				
	3000.	1556.8				

BLANK CARD ENDING CHARACTERISTIC
BLANK CARD ENDING "ARRDAT" CASES
BLANK CARD ENDING "SATURATION" CASES
BEGIN NEW DATA CASE
BLANK

As for output, it begins with the familiar interpreted input data cards, through the blank card which ends the second piece of the characteristic at 3000. amperes. Then internal printout continues, and finally, there is printout of the card images which should be written to the punch (LUNIT7 file) --- cards which are to be used in some subsequent simulation as data belonging to a multi-phase ZnO arrester of Section 1.32 . After this, data input begins for the second example.

EMTP BEGINS. SEND (SPY, \$ATTACH, DEBUG, HELP, MODULE, STOP) :
DONE READING DISK FILE INTO EMTP CACHE. NUMCRD = 67 CARDS.
ELECTROMAGNETIC TRANSIENTS PROGRAM (EMTP), DIGITAL (DEC) VAX-11/780 TRANSLATION AS USED BY BPA IN PORTLAND, OREGON 97208; USA.
DATE (MM/DD/YY) AND TIME OF DAY (HH.MM.SS.) = 10/31/83 09:32.40 VAX/VMS PLOT FILE = A31093240.PL4
FOR INFORMATION, CONSULT THE 840-PAGE EMTP RULE BOOK DATED MARCH, 1983. PROGRAM VERSION = "M37."
INDEPENDENT LIST LIMITS FOLLOW. TOTAL LENGTH OF /LABEL/ EQUALS 175644 INTEGER WORDS. 752 900 1500 300 7500
120 4500 5250 225 480 150 150 15 1380 150 -9999 4 15 9000 1950 300 450 12000 9 1200 150

DESCRIPTIVE INTERPRETATION OF NEW-CASE INPUT DATA 1 INPUT DATA CARD IMAGES PRINTED BELOW, ALL 80 COLUMNS, CHARACTER BY CHARACTER.
0 1 2 3 4 5 6 7 8
0 0 0 0 0 0 0 0 0

MARKER CARD PRECEDING NEW DATA CASE. 1BEGIN NEW DATA CASE
COMMENT CARD. 1C BENCHMARK DC-39
COMMENT CARD. 1C TEST OF SUPPORTING PROGRAM "ARRDAT" WHICH DERIVES ZINC OXIDE
COMMENT CARD. 1C ARRESTER CHARACTERISTIC CARDS BY LEAST MEAN SQUARE FITTING.
COMMENT CARD. 1C THIS IS EXAMPLE OF EMTP RULE BOOK, AT END OF SECTION 7.2B .
REQUEST FOR MAGNETIC-SATURATION ROUTINE. 1SATURATION
FREQ=77 REQUESTS ZNO DATA GENERATOR. 1 77.
BUS NAMES FOR EACH PHASE. 1BRANCH RECA RECB RECC
COMMENT CARD. 1C SHOWN BELOW AS COMMENT CARD IS "M27." VERSION OF 1ST DATA CARD.
COMMENT CARD. 1C 2 412500. 3 2 01
ARRESTER. 2 3 2 1 0.413E+06 0.380E+06 1 2 3 2 1 412500. 380000.
RATINGS. 0.71E+03 0.19E+06 0.96E+00 0.30E+01 1 707.107 192000. .962 3.0 1.12 .001
(I,V) POINT. 0.100000E+01 0.104000E+04 1 1.0 1040.
(I,V) POINT. 0.200000E+01 0.105500E+04 1 2.0 1055.
(I,V) POINT. 0.500000E+01 0.107000E+04 1 5.0 1070.
(I,V) POINT. 0.100000E+02 0.108000E+04 1 10. 1080.
(I,V) POINT. 0.200000E+02 0.110000E+04 1 20. 1100.
(I,V) POINT. 0.500000E+02 0.112500E+04 1 50. 1125.
(I,V) POINT. 0.100000E+03 0.115000E+04 1 100. 1150.
BLANK CARD ENDS CHARACTERISTIC. 1BLANK CARD ENDING CHARACTERISTIC
(I,V) POINT. 0.200000E+03 0.118200E+04 1 200. 1182.
(I,V) POINT. 0.500000E+03 0.124000E+04 1 500. 1240.
(I,V) POINT. 0.100000E+04 0.128800E+04 1 1000. 1288.
(I,V) POINT. 0.200000E+04 0.135000E+04 1 2000. 1350.
(I,V) POINT. 0.300000E+04 0.139000E+04 1 3000. 1390.
BLANK CARD ENDS CHARACTERISTIC. 1BLANK CARD ENDING CHARACTERISTIC

```

***** ERROR STATISTICS *****
SEGMENT      LOCAL ERROR      ACCUMULATED ERROR
  1      0.5838939740E-01    0.5838939740E-01
  2      0.4318787687E-02    0.6270818508E-01

```

```

COMPARISON BETWEEN INPUT DATA AND THE RECALCULATED POINTS
INPUT VOLTAGE      INPUT CURRENT      CALCULATED CURRENT      &&&&&&&&
0.2716592538E+06    0.3000000000E+01    0.3697707231E+01
0.2755774161E+06    0.6000000000E+01    0.7188264878E+01
0.2794955785E+06    0.1500000000E+02    0.1384330666E+02
0.2821076867E+06    0.3000000000E+02    0.2131943045E+02
0.2873319031E+06    0.6000000000E+02    0.4996815251E+02
0.2938621736E+06    0.1500000000E+03    0.1418224270E+03
0.3003924441E+06    0.3000000000E+03    0.3934037950E+03
0.3087511904E+06    0.6000000000E+03    0.6480730609E+03
0.3239014180E+06    0.1500000000E+04    0.1440748041E+04
0.3364395374E+06    0.3000000000E+04    0.2714383329E+04
0.3526346083E+06    0.6000000000E+04    0.5945558306E+04
0.3630830412E+06    0.9000000000E+04    0.9675684425E+04

```

REPROCESS INPUT DATA. MULTIPLIER "A5" = 0.1120000000E+01

```

***** ERROR STATISTICS *****
SEGMENT      LOCAL ERROR      ACCUMULATED ERROR
  1      0.5838939740E-01    0.5838939740E-01
  2      0.4318787687E-02    0.6270818508E-01

```

```

COMPARISON BETWEEN INPUT DATA AND THE RECALCULATED POINTS
INPUT VOLTAGE      INPUT CURRENT      CALCULATED CURRENT      &&&&&&&&
0.3042583643E+06    0.3000000000E+01    0.3697707231E+01
0.3086467061E+06    0.6000000000E+01    0.7188264878E+01
0.3130350479E+06    0.1500000000E+02    0.1384330666E+02
0.3159606091E+06    0.3000000000E+02    0.2131943045E+02
0.3218117315E+06    0.6000000000E+02    0.4996815251E+02
0.3291256345E+06    0.1500000000E+03    0.1418224270E+03
0.3364395374E+06    0.3000000000E+03    0.3934037950E+03
0.3458013333E+06    0.6000000000E+03    0.6480730609E+03
0.3627695882E+06    0.1500000000E+04    0.1440748041E+04
0.3768122819E+06    0.3000000000E+04    0.2714383329E+04
0.3949507613E+06    0.6000000000E+04    0.5945558306E+04
0.4066530061E+06    0.9000000000E+04    0.9675684425E+04

```

***** 80-COLUMN CARD-IMAGE LISTING OF UNIT-7 PUNCHED CARDS. *****

```

-----
      1      2      3      4      5      6      7      8
      0      0      0      0      0      0      0      0
-----
C RATING = 192000.00 V-MULT = 0.96200E+00 I-MULT = 0.30000E+01 GAPPED
92RECA          5555.
C          VREFERENCE          VFLASHOVER
0.4125000000000000E+06    0.9212121212121212E+00
C          MULTIPLIER          EXPONENT          VMIN
0.505584788677184E+07    0.464199973324621E+02    0.632754084797274E+00
0.122767153039007E+05    0.166775903445228E+02    0.816748018907843E+00
          9999
0.973855407485265E+09    0.464199973324621E+02    0.564959004283280E+00
0.812681183459119E+05    0.166775903445228E+02    0.729239302596289E+00
          9999
92RECB          RECA          5555.
92RECC          RECA          5555.
-----

```

```

BUS NAMES FOR EACH PHASE.          1BRANCH RECA          RECB          RECC
COMMENT CARD.          1C          SHOWN BELOW AS COMMENT CARD IS "M27." VERSION OF 1ST DATA CARD.
COMMENT CARD.          1C          1          412500.          3          2          01
ARRESTER. 1 3 2 1 0.413E+06 0.380E+06          1          1          3          1          412500.          380000.
RATINGS. 0.71E+03 0.19E+06 0.96E+00 0.30E+01          1          707.107          192000.          .962          3.0          1.12          .001
(I,V) POINT. 0.100000E+01 0.104000E+04          1          1.0          1040.
(I,V) POINT. 0.200000E+01 0.105500E+04          1          2.0          1055.
(I,V) POINT. 0.500000E+01 0.107000E+04          1          5.0          1070.
(I,V) POINT. 0.100000E+02 0.108000E+04          1          10.          1080.
(I,V) POINT. 0.200000E+02 0.110000E+04          1          20.          1100.
(I,V) POINT. 0.500000E+02 0.112500E+04          1          50.          1125.
(I,V) POINT. 0.100000E+03 0.115000E+04          1          100.          1150.
(I,V) POINT. 0.200000E+03 0.118200E+04          1          200.          1182.
(I,V) POINT. 0.500000E+03 0.124000E+04          1          500.          1240.
(I,V) POINT. 0.100000E+04 0.128800E+04          1          1000.          1288.
(I,V) POINT. 0.200000E+04 0.135000E+04          1          2000.          1350.
(I,V) POINT. 0.300000E+04 0.139000E+04          1          3000.          1390.
BLANK CARD ENDS CHARACTERISTIC.          1BLANK CARD ENDING CHARACTERISTIC

```

Finally, consider the way execution of this routine ends. Shown below is the very end of the LUNIT7 listing for the final (second) example which was buried in the data case. After two blank cards, the familiar summary statistics of data-case termination appear:

```

0.572162955513520E+05    0.144460093305137E+02    0.815042442819117E+00
          9999
92RECB          RECA          5555.
92RECC          RECA          5555.
-----

```

BLANK CARD ENDS ARRESTER CASES.
BLANK CARD TERMINATING ALL SATURATION CASES.

1BLANK CARD ENDING "ARRDAT" CASES
1BLANK CARD ENDING "SATURATION" CASES

CORE STORAGE FIGURES FOR PRECEDING DATA CASE NOW COMPLETED. -----
A VALUE OF -9999 INDICATES DEFAULT, WITH NO FIGURE AVAILABLE.
SIZE LIST 1. NUMBER OF NETWORK NODES.
SIZE LIST 2. NUMBER OF NETWORK BRANCHES.
SIZE LIST 3. NUMBER OF DATA VALUES IN R, L, C TABLES.
SIZE LIST 4. NUMBER OF ENTRIES IN SOURCE TABLE.
SIZE LIST 5. STORAGE FOR (Y) AND TRIANGULARIZED (Y).
SIZE LIST 6. NUMBER OF ENTRIES IN SWITCH TABLE.

NO. TIMES =	0	PRESENT	PROGRAM
NO. FLOPS =	0	FIGURE	LIMIT (NAME)
		-9999	752 (LBUS)
		-9999	900 (LBRNCH)
		-9999	1500 (LDATA)
		-9999	300 (LEXCT)
		-9999	7500 (LYMAT)
		-9999	120 (LSWTCH)

To conclude the illustrative documentation, I display a listing of the card images which were written on the LUNIT7 file. Note that there really are two unrelated groupings, corresponding to the two subcases that were buried in the EMTF data case:

RATING =192000.00 V-MULT = 0 96200E+00 I MULT = 0 30000E+01 GAPPED
9 2RECA 5555.
VREFERENCE WFLASHOVER
0.412500000000000E+06 0.9212121212121E+00
MULTIPLIER EXPONENT VMIN
0.294795442961156E+05 0.265302624185337E+02 0.545050636122854E+00
9999
0.596059571777280E+06 0.265302624185337E+02 0.486652275816743E+00
9999

9 2RECB RECA 5555.
9 2RECC RECA 5555.
RATING =192000.00 V-MULT = 0 96200E+00 I-MULT = 0.30000E+01 GAPPED
9 2RECA 5555.
VREFERENCE WFLASHOVER
0.412500000000000E+06 0.9212121212121E+00
MULTIPLIER EXPONENT VMIN
0.505584788677199E+07 0.464199973324622E+02 0.632754084797274E+00
0.122767153039006E+05 0.166775903445228E+02 0.816748018907843E+00
9999
0.973862640531210E+09 0.464199973324622E+02 0.564958913889840E+00
0.812683352032399E+05 0.166775903445228E+02 0.729239185918000E+00
9999

9 2RECB RECA 5555.
9 2RECC RECA 5555.
RATING =192000 00 V-MULT = 0.96200E+00 I-MULT = 0.30000E+01 GAPPED
9 2RECA 5555.
VREFERENCE WFLASHOVER
0.412500000000000E+06 0.9212121212121E+00
MULTIPLIER EXPONENT VMIN
0.750282041334556E+07 0.484039509531899E+02 0.639499429775568E+00
0.244892766439866E+10 0.684088433742134E+02 0.748760917888152E+00
0.110464775993159E+07 0.394755404048771E+02 0.766237290359516E+00
0.846634377521047E+05 0.279345803478540E+02 0.800464072361846E+00
0.164899969440839E+05 0.187565472092775E+02 0.836738184231502E+00
0.111305268446436E+05 0.144460093305137E+02 0.912847535957411E+00
9999
0.180956701025145E+10 0.484039509531899E+02 0.570981542371124E+00
0.570070693109104E+13 0.684088433742134E+02 0.668536426862862E+00
0.968578003188225E+08 0.394755404048771E+02 0.684140328358526E+00
0.200716302920820E+07 0.279345803478540E+02 0.714699950256781E+00
0.138159910829861E+06 0.187565472092775E+02 0.747087544958386E+00
0.572164277990577E+05 0.144460093305137E+02 0.815042312412326E+00
9999

9 2RECB RECA 5555.
9 2RECC RECA 5555.

7.4 "LINE CONSTANTS" Routine

By means of the special request word "LINE CONSTANTS", an EMTP user gains access to the supporting routine which bears this same name, as per the explanation of Section 7. The principal function of this code is to calculate the resistance, inductance, and capacitance matrices which correspond to an arbitrary configuration of overhead conductors.

Prior to July of 1976, the code in question existed as a self-contained, separate program which went by the name of "BPA Line Constants Program". It was originally written by Dr. Hermann W. Dommel, who is now Professor of Electrical Engineering at the University of British Columbia in Vancouver. Details of the incorporation of this routine into the EMTP are covered in the 11-page EMTP memo which is dated June 28, 1976.

So as to leave the original (master) copy of the User's Manual of the BPA Line Constants Program intact, the following 70 or so pages began with a copy. Rather than use a BPA copy, I have availed myself of a B.C. Hydro copy, which was given to me last summer at our July 19, 1976 EMTP reunion by Dr. Brian Dixon of that organization. It would appear that B.C. Hydro has done some editorial enhancement, which included the re-typing of a substantial portion of the text. Differences in typewriter font will indicate to the careful observer those passages which have been typed at B.C. Hydro. Hermann's originals are characterized by the same font as is being used for the present paragraph.

The structure of a data case for "LINE CONSTANTS" is as follows:

1. First comes a "BEGIN NEW DATA CASE" card (actually optional, as per Section 1.0a).
2. Next comes a "LINE CONSTANTS" card, which serves to transfer control to the overlay in question (UTPF overlay number 44).
3. Next come the "conductor cards," which define the line geometry and some of its fundamental electrical properties. There is to be one such card for each physical conductor; a blank card is used to terminate this class of data.
4. Next come the "frequency cards," each of which specifies a new earth resistivity and frequency (or range of frequencies) for which line constants are to be calculated. Such cards are to be terminated by a blank card.
5. Repeat the data of Points 3 and 4 above as often as is desired. Each such group of data represents an independent data case within the "LINE CONSTANTS" overlay. Terminate the last such grouping with a blank card, which serves to transfer control back to the regular EMTP solution-mode, ready to read in a new EMTP data case.
6. If the user wants to shut off the EMTP at this point (rather than execute a following EMTP data case), he should simply add a "BEGIN NEW DATA CASE" card at this point, followed by a blank card. This is as per Section 1.0b.

Variable Dimensioning of "LINE CONSTANTS" Code

As with all other non-solution overlays of the EMTP which require variable-dimensioning, this capability has been provided via a "VDOV" module (SUBROUTINE VDOV44). The available space for "LINE CONSTANTS" arrays is equal to that of /LABEL/, minus a constant offset (which allows for the excess space required by the compiled code itself). EMTP variable dimensioning allows the user to control the size of /LABEL/ at will, of course (see Section 0.6). Hence "LINE CONSTANTS" is variably-dimensioned, indirectly.

Normally, data cases for "LINE CONSTANTS" will just execute without any difficulty related to dimensioning, and the user need not be at all concerned with program dimensions. Yet there are three distinct ways in which the user might possibly get into trouble, should insufficient central memory be available. For completeness, these shall be listed here:

Bomboff #1

First, suppose that /LABEL/ (as produced by the user's preceding variable-dimensioning operation) is exceedingly small. Suppose further that the user is running the EMTP on a non-Virtual machine, within a central memory partition which is barely adequate for conventional time-step-loop simulations. Then it is possible that the operating system could terminate execution of the run as the EMTP attempts to transfer control from "MAIN00" to "OVER44" (the overlay of the "LINE CONSTANTS" code). Remedy: re-dimension the EMTP in a less-miserly fashion. For CDC in the Spring of 1977, perhaps 4000 or 5000 cells of /LABEL/ is needed as a minimum, in order to escape the fate of Bomboff #1.

Bomboff #2

Having barely escaped Bomboff #1, it is possible for program control to get into "OVER44" only to discover that there is not enough storage available for even two conductors (2 x 2 matrices). For a Virtual machine which will never run into Bomboff #1, it is Bomboff #2 which will be the standard indication of insufficient size for /LABEL/. A standard EMTP error-termination (KILL-code) message will result, describing the problem. In this case, data input can not even be begun. Remedy: same as for Bomboff #1 above.

Bomboff #3

If the user escapes Bomboffs #1 and #2, then data input for the "LINE CONSTANTS" case begins. But should too many conductor cards for the given dimensioning (size of /LABEL/) be read, then a conventional EMTP error message will result (e.g., see Section 2.4). The error printout will indicate the conductor limit which has been exceeded. Then in order to know how much /LABEL/ must be expanded, the user is advised to consult the following constraint between the maximum number of conductors "n" and the total available array space "T" :

$$T = \frac{11 n^2}{8} + \frac{91 n}{4} + 9$$

For example, suppose that the error-stop printout indicates that the current program limit is 12 conductors. If the data case in question actually has 23, the user might decide to redimension for a limit of 30. To do this, /LABEL/ will have to be expanded by at least $1929 - 480 = 1449$ floating-point words. The storage is predominately REAL.

n	T
3	90
6	195
12	480
18	864
30	1929
40	3119
50	4584

Format for Conductor Cards (Point 3 "LINE CONSTANTS" data)

For each physical conductor which belongs to the overhead transmission line, one card is to be punched according to the following format:

IPHASE	SKIN	RESIS	IXTYPE	REACT	DIAM	HORIZ	VTOWER	VMID	SEPAR	ALPHA	NAME	IBUND
I3	F5.4	F8.5	I2	F8.5	F8.5	F8.3	F8.3	F8.3	F8.5	F6.2	A6	I2
METRIC	Ω / km		See Exception 2 below	CM	meters	meters	meters	CM				
ENGLISH	Ω / mile			inch	feet	feet	feet	inch				

- IPHASE ---- The phase number (an integer) to which this conductor belongs. Punch as zero for a ground wire (ground is phase number zero, by definition). If more than one conductor is punched with the same phase number, this means that those conductors are to be bundled (electrically connected in parallel). Use numbers 1, 2, etc. without any missing (unused) entries, when numbering the phases.
(1-3)
- SKIN ----- Field which is usually punched with the ratio T/D , where:
(4-8) $\left\{ \begin{array}{l} T = \text{thickness of tubular conductor;} \\ D = \text{outside diameter of tubular conductor.} \end{array} \right.$
For a solid conductor, use 0.5, note.
See Exception 1 below, for an infrequently-used alternative.
- RESIS ---- Dc resistance of the conductor, in units of:
(9-16) $\left\{ \begin{array}{l} \text{ohm / kilometer} \quad \text{----} \quad \text{if "METRIC"} \\ \text{ohm / mile} \quad \text{-----} \quad \text{if "ENGLISH"} \end{array} \right.$
See Exception 1 below, for an infrequently-used alternative.
- IXTYPE --- Usually punched with a "4".
(17-18) See Exception 2 below, for several infrequently-used alternatives.
- REACT --- Usually left blank.
(19-26) See Exception 2 below, for several infrequently-used alternatives.
- DIAM --- Outside diameter of tubular conductor, in units of:
(27-34) $\left\{ \begin{array}{l} \text{centimeters} \quad \text{----} \quad \text{if "METRIC"} \\ \text{inches} \quad \text{-----} \quad \text{if "ENGLISH"} \end{array} \right.$

HORIZ ----- Horizontal separation of the center of the conductor from
(35-42) some reference line, in units of:

$$\left\{ \begin{array}{ll} \text{meters} & \text{----- if "METRIC"} \\ \text{feet} & \text{----- if "ENGLISH"} \end{array} \right.$$

Location of the reference line is arbitrary; distances to the right of it are positive, while those to the left are negative.

VTOWER ----- Vertical height of the conductor above the ground,
(43-50) at the tower, in units of:

$$\left\{ \begin{array}{ll} \text{meters} & \text{----- if "METRIC"} \\ \text{feet} & \text{----- if "ENGLISH"} \end{array} \right.$$

See Exception 3 below, for an alternative.

VMID ----- Vertical height of the conductor above the ground,
(51-58) at mid-span (midway between two towers), in units of:

$$\left\{ \begin{array}{ll} \text{meters} & \text{----- if "METRIC"} \\ \text{feet} & \text{----- if "ENGLISH"} \end{array} \right.$$

See Exception 3 below, for an alternative.

SEPAR
ALPHA ----- Leave blank, unless the automatic bundling option
(59-72) is desired, as explained in Exception 4 below.

NAME ----- Leave blank, unless the change-case option is to be
(73-78) used, as explained in Exception 5 below.

NBUND ----- Leave blank, unless the automatic bundling option
(79-80) is desired, as explained in Exception 4 below.

The just-delineated rules apply to the most common, basic "LINE CONSTANTS" usage; they are the most frequently-used alternative. Yet other options are available, as shall now be explained.

Exception 1 : Bypass skin effect calculation

If the skin-effect correction (or calculation) is to be bypassed (omitted), then enter 0.0 in the field "SKIN" of columns 4-8. Also for such a case, field "RESIS" of columns 9-16 is to be punched with the conductor ac (not dc) resistance. Recall that ac resistance is equal to dc resistance plus a skin-effect contribution which depends on frequency, among other things.

Exception 2 : Alternative self-inductance calculation

Rather than have the program calculate self-inductance based on the tubular conductor geometry, four other alternatives are available to the user. All involve the reading of one additional floating-point number, from field "REACT" of columns 19-26. Internal inductance is not corrected for the skin effect in any of these four alternatives. Type code "IXTYPE" of columns 17-18 can take on four alternate values to the usual "4"-punch, as follows:

IXTYPE	REACT (19-26)
0	Reactance for unit spacing, assumed to be valid for whatever frequencies may be encountered on frequency cards which follow. The unit spacing is: $\left\{ \begin{array}{ll} \text{one meter} & \text{----- if "METRIC"} \\ \text{one foot} & \text{----- if "ENGLISH"} \end{array} \right.$ The reactance "REACT" is in units of: $\left\{ \begin{array}{ll} \text{ohm/kilometer} & \text{---- if "METRIC"} \\ \text{ohm / mile} & \text{----- if "ENGLISH"} \end{array} \right.$
1	Just like immediately above, only this reactance only applies at 60 Hertz. If frequencies different than this will be encountered on frequency cards which follow, the reactance will be changed proportionately.
2	GMR (geometric mean radius) of the conductor, in units of: $\left\{ \begin{array}{ll} \text{centimeters} & \text{----- if "METRIC"} \\ \text{inches} & \text{----- if "ENGLISH"} \end{array} \right.$
3	Dimensionless ratio GMR / r , where "r" is the conductor outer radius. For solid conductors, this ratio is equal to .7788.

Exception 3 : Usage of conductor vertical heights

Before considering alternatives, first consider how "VTOWER" and "VMID", the conductor vertical heights at the tower and at mid-span, enter the calculation. It may be recalled that Carson's formula requires conductors to be parallel to the (assumed) flat earth. Of course conductors always sag, so an average height must be used as an approximation. The program uses

$$VMID + \left[\frac{VTOWER - VMID}{3} \right] = 2/3 \cdot VMID + 1/3 \cdot VTOWER$$

if both fields are punched non-zero.

If one of the two data fields "VTOWER" and "VMID" is left blank, the program assumes a value equal to that which was read from the other field. This is the way the user can input the average height himself ---- by just punching one of the two fields.

Exception 4 : Automatic bundling option

Rather than specify each conductor of a bundle individually, there is an automatic bundling option which allows a single conductor card to suffice for specification of the entire bundle. This can be used for a "regular" bundle, where by definition all component conductors are identical, and such conductors are also assumed to be uniformly spaced around the circumference of a circle.

Automatic bundling uses the data fields "SEPAR", "ALPHA", and "NBUND", which are otherwise left blank. The "conductor" card then becomes a "bundle" card, as per the following specification:

SEPAR (59-66) ----- Separation between adjacent conductors in the bundle, in units of:

{	centimeters -----	if "METRIC"
	inches -----	if "ENGLISH"

ALPHA (67-72) ----- Angular position of the first conductor (or any conductor) of the bundle, in units of degrees. Positive angles are measured counter-clockwise, as shown in the sketch.

NBUND (79-80) ----- Number of conductors which make up the bundle.

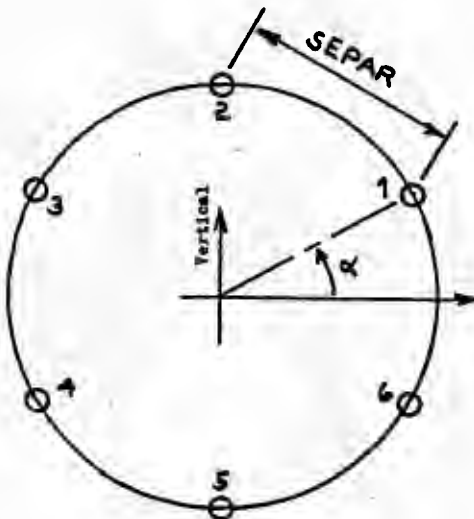

Sample sketch of a bundle of NBUND = 6 conductors, with angle "ALPHA" equal to 30 degrees.

Exception 5 : Naming of conductors for change-case identification

Data field "NAME" of columns 73-78 is normally left blank, unless a following data case within "LINE CONSTANTS" is to make use of the change-case feature. See later explanation. For such change-case usage, conductors must be identified. A 6-character alphanumeric name is used for this purpose, punched in columns 73-78 using A6 format. Only those conductors which will later be referenced must be given distinct 6-character names.

Format for Frequency Cards (Point 4 "LINE CONSTANTS" data)

For each discrete frequency or logarithmically-spaced grouping of frequencies for which line constants are to be calculated, there is to be a frequency card of the following format:

Earth resistivity	frequency	Carson accuracy	Print [C]	Print [E]	distance	Print P _i	1-SEG MUTUAL	IDEC	IPNT	IPUN	MODAL	ITRNSF
RHO	FREQ	FCAR	ICPR	IZPR	DIST	IPIPR	I1	I3	I3	I3	I2	I2
F8.2	F10.2	F10.6	G11	G11	F2.3	A11						

RHO ---- Resistivity of the homogeneous Carson earth, in units of ohm-meters. These units apply both to "METRIC" and "ENGLISH" data cases.
(1-8)

FREQ --- Frequency f of the line constants calculation, in units of Hertz. For logarithmic looping over two or more frequencies, this is the beginning frequency f_1 (see "IDEC" of columns 60-62).
(9-18)

FCAR --- Punch a "1" in column 28, in order to get full precision in the evaluation of Carson's formula. This is the standard production usage. Other options are described elsewhere.
(19-28)

ICPR --- Printout control parameters for the capacitance matrices $[C]$, or the susceptance matrices $\omega[C]$, or the inverses of these. Variable "ICAP" of column 44 controls the inverse option, note. Six possible independent printed outputs can be requested by means of "1" punches in the appropriate columns:
(30-35)

Column #	Resulting printout
30	Inverse of $[C]$ or $\omega[C]$
31	Inverse of $[C_E]$ or $\omega[C_E]$
32	Inverse of $[C_S]$ or $\omega[C_S]$
33	$[C]$ or $\omega[C]$
34	$[C_E]$ or $\omega[C_E]$
35	$[C_S]$ or $\omega[C_S]$

Here subscripts (or lack of them) have meaning:

none ---- for the unreduced system. Each physical conductor has a row and column in the matrix, as does each ground wire.

"E" ---- for the equivalent phase conductors (after elimination of ground wires and the bundling of conductors).

"S" ---- for the symmetrical components of the equivalent phase conductors.

IZPR (37-42) ---- Printout control parameters for the series impedance matrices $[Z] = [R] + j\omega[L]$ or their inverses. Six possible independent printed outputs can be requested by means of "1" punches in the appropriate columns:

Col. #	37	38	39	40	41	42
Output	Z	Z _E	Z _S	Z ⁻¹	Z _E ⁻¹	Z _S ⁻¹

ICAP (44) ---- Control over whether it is $[C]$ or $\omega[C]$ that will be outputted by any "ICPR" requests of columns 30-35 :

$$\begin{cases} 1 \Rightarrow [C] \text{ or its inverse} \\ 0 \Rightarrow \omega[C] \text{ or its inverse} \end{cases}$$

DIST (45-52) ---- Length of the transmission line under consideration, in units of $\begin{cases} \text{kilometers} & \text{---- if "METRIC"} \\ \text{miles} & \text{----- if "ENGLISH"} \end{cases}$

This field can usually be left blank. It need be punched only for the following situations:

- 1) For use with "SEMLYEN SETUP" ; see Section 7.5
- 2) For the development of a Pi-equivalent using long-line formulas. See "IPIPR" below.
- 3) For use with "JMARTI SETUP" ; see Section 7.0

IPIPR (54-57) ---- Printout control for the equivalent-Pi matrices of a long transmission line. Four possible independent printed outputs can be requested by means of "1" punches in the appropriate columns:

Col. #	54	55	56	57
output	Y	Y _S	Z	Z _S

See further discussion elsewhere.

ISEG (58) ---- A flag indicating whether ground wires (if any) are to be treated as being continuous, or instead segmented:

$$\begin{cases} 0 \Rightarrow \text{continuous ground wires (the normal case);} \\ 1 \Rightarrow \text{segmented ground wires (cut at relatively short intervals).} \end{cases}$$

See further discussion elsewhere.

MUTUAL (59) ---- A flag which is used to indicate the presence of a communication circuit parallel to the power circuit:

$$\begin{cases} 0 \Rightarrow \text{there is no such communication circuit (which is the normal case);} \\ 1 \Rightarrow \text{yes, produce special output for a nearby communication circuit. See further discussion elsewhere.} \end{cases}$$

IDEC ----- Leave blank for the normal single-frequency line constants calculation.
(60-62)

For the case of internal looping over logarithmically-spaced frequencies, "IDEC" is the number of decades which are to be spanned.

IPNT ----- Leave blank for the normal single-frequency line constants calculation.
(63-65)

For the case of internal looping over logarithmically-spaced frequencies, "IPNT" is the number of points per decade at which line constants are to be calculated.

IPUN ----- Normally this field is left blank. It can be used to request non-printed output of modal quantities, in the case of internal looping over logarithmically-spaced frequencies. Punch :

"88" ----- For the connection of zero-sequence (ground mode) impedances with "WEIGHTING". This has meaning only when a "LINE CONSTANTS" data case is imbedded in a "WEIGHTING" data case.

"89" ----- As just described for "88", only for the Karrenbauer line mode (rather than the ground mode).

It can also be used to request punched output for the PI-circuit representation of the line. This is done by setting IPUN = 44. Please read the following "NOTE" for details.

MODAL ----- { 0 or blank ==> The line is assumed to be continuously-transposed.
(69-70) { 1 ==> The line is assumed to be untransposed. The modal parameters and transformation matrix will be calculated and written on unit LUNIT7 as branch data (see Section 1.26).

ITRNSF ----- Through this variable, user can request either the full complex, or real part only, transformation matrix for the modal analysis of untransposed lines. When this variable is used in a "JMARTI SETUP" (see Section 7.0) case, it has meaning only on the 1st frequency card where the constant transformation matrix is calculated:

{ 0 or blank ==> The imaginary part of the transformation matrix calculated by the "LINE CONSTANTS" is ignored in the modal analysis. Always use this option, in general (see Ref. 8, Vol. XIII, 5 March 1983. pagination MCAP-26, and EMTF Newsletter, Vol. 3, No. 1, August, 1982, p. 76).
or -2
9 ==> The full complex transformation matrix calculated by the "LINE CONSTANTS" is used

Note : The automatic punching (LUNIT7) of EMTF branch cards for the Pi-circuit representation of transmission lines is now possible:

123a

- 1) Input "IPUN" equal to 44 in columns 67-68 on the frequency card of the "LINE CONSTANTS" data.
- 2) The optional "BRANCH" card which names the nodes of all the branches representing the line can be used right after the "LINE CONSTANTS" card.

BRANCH	BUS1	BUS2	BUS3	BUS4	BUS5	BUS6	BUS7	BUS8	BUS9	BUS10	BUS11	BUS12
	A6	A6	A6	A6	A6	A6	A6	A6	A6	A6	A6	A6

- 3) The Pi-circuits representation branch cards are generated on LUNIT7 with the "high-precision format" described on page 6c of the EMTF rule book. The units for R, L and C are in ohm/length, ohm/length and microfarad/length. So the user should remember to use XOPT = 60 and COPT = 0.0 when incorporating this LUNIT7 branch data in the EMTF simulation data case; and multiply all the R, L, C data on LUNIT7 by the length of the section.

The following is an example to illustrate this option: first, the data for running "LINE CONSTANTS":

```

BEGIN NEW DATA CASE
LINE CONSTANTS
BRANCH JDA LMA JDB LMB JDC LMC
C LINE CONSTANTS DATA FOR JOHN DAY TO LOWER MONUMENTAL 500-KV LINE.
1.3636 .05215 4 1.602 -20.75 50. 50.
1.3636 .05215 4 1.602 -19.25 50. 50.
2.3636 .05215 4 1.602 -0.75 77.5 77.5
2.3636 .05215 4 1.602 0.75 77.5 77.5
3.3636 .05215 4 1.602 19.25 50. 50.
3.3636 .05215 4 1.602 20.75 50. 50.
0.5 2.61 4 0.386 -12.9 98.5 98.5
0.5 2.61 4 0.386 12.9 98.5 98.5
BLANK CARD ENDING CONDUCTOR CARDS OF "LINE CONSTANTS" CASE
C THE FOLLOWING FREQUENCY CARD HAS A PUNCH OF 44 IN COL. 67-68 TO
C REQUEST THE PI-CIRCUITS PUNCHED OUT GENERATED ON LUNIT7
27. 60.00 1 44
BLANK CARD ENDING FREQUENCY CARDS OF "LINE CONSTANTS" CASE
BLANK CARD ENDING "LINE CONSTANTS" CASES
BEGIN NEW DATA CASE
BLANK
  
```

The resulting Pi-circuits branch cards which generated on LUNIT7 are:

```

$VINTAGE, 1
1JDA LMA 0.17132E+00 0.95404E+00 0.16829E-01
2JDB LMB 0.15827E+00 0.35855E+00 -0.26357E-02
3JDC LMC 0.20598E+00 0.92069E+00 0.17162E-01
0.14307E+00 0.35417E+00 -0.19751E-02
0.15827E+00 0.35855E+00 -0.26357E-02
0.17132E+00 0.95404E+00 0.16829E-01
$VINTAGE, 0
  
```

123 b

Next is an example of LINE CONSTANTS data case of a 70 mile long double circuit using K.C. Lee's untransposed transmission line model:

BEGIN NEW DATA CASE

C BENCHMARK DC-69

C THIS CASE GENERATES THE BRANCH CARDS ON LUNIT7 OF A 70 MILES DOUBLE-CIRCUIT LINE BETWEEN RAVEN AND CHIEF JOE

C THE LINE IS MODELED BY USING THE NEW UNTRANSPOSED DISTRIBUTED-

C PARAMETER REPRESENTATION DEVELOPED BY DR. K. C. LEE

LINE CONSTANTS

BRANCH	X2A	X16A	X2B	X16B	X2C	X16C	Y2A	Y16A	Y2B	Y16B	Y2C	Y16C
1	.375	.0776	4	.0	1.302	-21.17	51.04					
1	.375	.0776	4	.0	1.302	-22.00	50.00					
1	.375	.0776	4	.0	1.302	-22.83	51.04					
2	.375	.0776	4	.0	1.302	.83	79.14					
2	.375	.0776	4	.0	1.302	0.00	78.10					
2	.375	.0776	4	.0	1.302	-.83	79.14					
3	.375	.0776	4	.0	1.302	22.83	51.04					
3	.375	.0776	4	.0	1.302	22.00	50.00					
3	.375	.0776	4	.0	1.302	21.17	51.04					
4	.375	.0776	4	.0	1.302	103.83	51.04					
4	.375	.0776	4	.0	1.302	103.00	50.00					
4	.375	.0776	4	.0	1.302	102.17	51.04					
5	.375	.0776	4	.0	1.302	125.83	79.14					
5	.375	.0776	4	.0	1.302	125.00	78.10					
5	.375	.0776	4	.0	1.302	124.17	79.14					
6	.375	.0776	4	.0	1.302	147.83	51.04					
6	.375	.0776	4	.0	1.302	147.00	50.00					
6	.375	.0776	4	.0	1.302	146.17	51.04					
0	.500	2.6100	4	.0	.386	12.90	101.40					
0	.500	2.6100	4	.0	.386	-12.90	101.40					
0	.500	2.6100	4	.0	.386	137.90	101.40					
0	.500	2.6100	4	.0	.386	112.10	101.40					

BLANK CARD ENDING CONDUCTOR CARDS OF "LINE CONSTANTS" CASE

100.0 60.0 1 1 70. 1

BLANK CARD ENDING FREQUENCY CARS OF "LINE CONSTANTS" CASE

BLANK CARD ENDING "LINE CONSTANTS" CASES

BEGIN NEW DATA CASE

BLANK

Interpretation of Input Data Cards

As explained in Section 2.1, input data cards are listed in columns 52-131 of the line printer; a "1" is printed in column 51 as a separator character, and columns 1-50 are used for "interpretation" of the card image. All interpretations related to "LINE CONSTANTS" are explained in the present section.

First, there is the special request card which bears the key word "LINE CONSTANTS" (see Section 1.0g). If we let variable "LIM" stand for the maximum number of line conductors that current EMTP dimensioning will allow, interpretation is as follows:

1	2	3	4	5	6	7	8	9	10	11	12	13	14	15	16	17	18	19	20	21	22	23	24	25	26	27	28	29	30	31	32	33	34	35	36	37	38	39	40	41	42	43	44	45	46	47	48	49	50	51
REQUEST FOR LINE-CONSTANTS SUPPORTING PROG.																																											IG							1
																																											LIM							1

Next comes a possible "METRIC" or "ENGLISH" special request card (which serves to request either metric or English units for input/output data). Interpretations of these two optional cards are as follows:

1	2	3	4	5	6	7	8	9	10	11	12	13	14	15	16	17	18	19	20	21	22	23	24	25	26	27	28	29	30	31	32	33	34	35	36	37	38	39	40	41	42	43	44	45	46	47	48	49	50	51
REQUEST CARD FOR METRIC UNITS ON ALL DATA.																																																	1	
ENGLISH																																																	1	

Next come the line conductor cards, which are interpreted as follows:

1	2	3	4	5	6	7	8	9	10	11	12	13	14	15	16	17	18	19	20	21	22	23	24	25	26	27	28	29	30	31	32	33	34	35	36	37	38	39	40	41	42	43	44	45	46	47	48	49	50	51
LINE-CONDUCTOR CARD.																				E11.3							E11.3							IG							1									
																				SKIN							RESIS							IXTYPE							1									

Next come frequency cards, which bear the following interpretation:

1	2	3	4	5	6	7	8	9	10	11	12	13	14	15	16	17	18	19	20	21	22	23	24	25	26	27	28	29	30	31	32	33	34	35	36	37	38	39	40	41	42	43	44	45	46	47	48	49	50	51
FREQUENCY CARD.																				E11.3							E11.3							E11.3							1									
																				REARTH							FREQ							DIST							1									

The beginning of a change case is a special-request card which bears the key word "CHANGE". This is interpreted as follows:

1	2	3	4	5	6	7	8	9	10	11	12	13	14	15	16	17	18	19	20	21	22	23	24	25	26	27	28	29	30	31	32	33	34	35	36	37	38	39	40	41	42	43	44	45	46	47	48	49	50	51
REQUEST CARD FOR CHANGE-CASE OPTION.																																																		1

Blank cards are used to mark the ends of three classes of data within the "LINE CONSTANTS" supporting program:

- 1) Conductor cards;
- 2) Frequency cards; and
- 3) Data cases within "LINE CONSTANTS" .

These are interpreted as follows:

1	2	3	4	5	6	7	8	9	10	11	12	13	14	15	16	17	18	19	20	21	22	23	24	25	26	27	28	29	30	31	32	33	34	35	36	37	38	39	40	41	42	43	44	45	46	47	48	49	50	51
BLANK CARD TERMINATING CONDUCTOR CARDS.																																																		1
BLANK CARD TERMINATING FREQUENCY CARDS.																																																		1
BLANK CARD TERMINATING LINE-CONSTANTS CASES.																																																		1

Sample "LINE CONSTANTS" EMTF Data Case

As a sample EMTF data case which uses "LINE CONSTANTS", consider a listing of UTPF Test Case #108. Comment cards will be noted in the listing below. Note that within this one EMTF data case, there are two "LINE CONSTANTS" data cases. The first uses "ENGLISH" units, while the second uses "METRIC". Only a single frequency (60 Hz) is involved in each.

```

BEGIN NEW DATA CASE
C UTPF TEST CASE NO. 108
C CALCULATE LINE CONSTANTS FOR OVERHEAD LINE USING "LINE CONSTANTS".
C THE LINE IS UNTRANSPOSED, WITH ONE CONDUCTOR PER PHASE.
C SINGLE 3-PHASE CIRCUIT, WITH 2 GROUND WIRES.
C THIS IS A COMPANION CASE TO UTPF TEST CASE NO. 107.
C THE GEOMETRY OF THE OVERHEAD LINE IS THE SAME IN THESE TWO CASES.
C OF COURSE, HERE WE MUST USE THE HOMOGENEOUS EARTH (1-LAYER).
LINE CONSTANTS
ENGLISH
1.3871.26715 4 .688 0.0 82.02 41.01 15.75 45. 4
2.3871.26715 4 .688 45.93 82.02 41.01 15.75 45. 4
3.3871.26715 4 .688 91.86 82.02 41.01 15.75 45. 4
0.5 .71890 4 .487 9.81 114.83 57.42
0.5 .71890 4 .487 82.02 114.83 57.42
200. 60. Blank card ending conductor cards
1 111111 111111 1 49.71
Blank card ending frequency cards
METRIC
1.3871.16603 4 1.748 0.0 25.0 12.5 40. 45. 4
2.3871.16603 4 1.748 14.0 25.0 12.5 40. 45. 4
3.3871.16603 4 1.748 28.0 25.0 12.5 40. 45. 4
0.5 .4468 4 1.236 3.0 35. 17.5
0.5 .4468 4 1.236 25.0 35. 17.5
200. 60. Blank card ending conductor cards
1 111111 111111 1 80.0
Blank card ending frequency cards
Blank card ending "LINE CONSTANTS" data cases.
BEGIN NEW DATA CASE

```

The EMTF line printer output corresponding to the solution of this data case begins as shown on the following page. It will be noted that there is always printout of a sorted line-conductor table, before printout of any of the requested matrices.

Instructions for Punching Conductor Cards

TIME-SAVING FEATURES

- 1) Identical conductors: If any of the first 6 variables on the card (phase number, skin effect, resistance, X-type, reactance or diameter) are left blank (punching a zero is not blank!), the variable value will be assumed to be the same as it was on the previous card. However, the horizontal distance and at least one height position must be punched for each conductor.

- 2) Bundle conductors: A bundle of K conductors can be identified in two ways. One can either punch a card for each of the K conductors or punch only one card for the entire bundle. Both ways are shown in the example on the preceding page. If the entire bundle is specified on one card, then
 - (a) specify the location of the centre of the bundle in the fields for horizontal distance and heights,
 - (b) specify SEPARATION of adjacent conductors of a bundle (inches). Bundled conductors are assumed to be arranged on a circle around the center at equal distances (or equal angles).
 - (c) specify ANGULAR LOCATION α of first conductor. Positive angles are measured counter-clockwise from the center (see sketch).
 - (d) specify NUMBER OF CONDUCTORS in the bundle (this variable plus separation determines the diameter of the bundle).

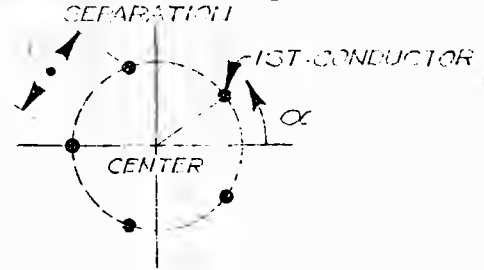

EXPLANATION OF PARAMETERS

Phase Number: A phase on a transmission line may consist of more than 1 conductor (bundle conductors or parallel connected circuits). The PHASE NUMBER defines to which phase the conductor belongs. Number the phases 1 to N consecutively and use "0" for ground wires. Conductors with phase number "0" will be eliminated as ground wires and conductors with identical phase numbers will be bundled into one equivalent phase conductor, no matter whether the bundle is specified on one conductor card or by individual conductor cards. If PHASE-NUMBER < 0 then the conductor is regarded as non-existent (helpful in change cases when removing conductors).

Skin Effect Correction:

= 0, if no skin effect correction is desired.

= $\frac{T}{D}$ if resistance and internal inductance (the latter only when XTYPE=4) are to be corrected for skin effect with the formula for tubular conductors, whereby

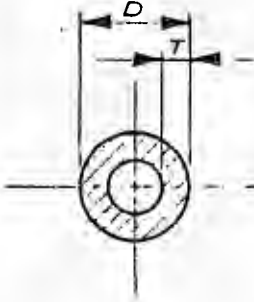

$$\frac{T}{D} = \frac{\text{thickness of tube}}{\text{diameter of tubular conductor}}$$

Note that $\frac{T}{D} = 0.5$ for solid conductors.

Resistance: Conductor resistance in Ω/mile for direct current (or for specific frequency if there is no skin effect correction).

Reactance Data: There are five options for input of reactance data, depending on the value of X-TYPE.

XTYPE = 0: Reactance for 1'-spacing.* This is regarded as the correct value for whatever frequencies may be defined on the following frequency cards.

= 1: Reactance for 1' spacing at 60 Hz.* If frequencies other than 60 Hz appear on the frequency cards, the reactance will be changed proportionately.

= 2: GMR (geometric mean radius) of conductor in inches.

= 3: ratio GMR/radius (is 0.7788 for solid conductors).

= 4: Reactance computed from geometry of tubular conductor (defined by $\frac{T}{D}$.) Value for reactance data is ignored. This $\frac{T}{D}$ is indicated in output. Internal inductance is corrected for skin effect.

Internal inductance is not corrected for skin effect

* Relationship between reactance for 1'-spacing and GMR (geometric mean radius):

$$X_{1'\text{ spacing}} (\Omega/\text{mile}) = \frac{f[\text{Hz}]}{100} \times 0.20223653 \ln \frac{12}{GMR[\text{inches}]}$$

$$2 \omega \times 1.609344 \times 10^{-4}$$

Diameter: Conductor diameter in inches.

Horizontal Distance: Horizontal distance of middle of conductor from the reference mark. The reference mark may be located anywhere (often, the middle of the tower structure is used as reference).

Height at Tower:

Height at Midspan: The average height of the conductor is taken as $\text{HEIGHT AT MIDSPAN} + 1/3 \times (\text{HEIGHT AT TOWER} - \text{HEIGHT AT MIDSPAN})$. If the average height is used as input, punch the same value in both fields or leave one blank (if either one is left blank (not '0') then its value will be assumed to be identical to the other one).

Conductor Name: Can be left blank if no change cases are run:
Serves to identify conductors for change cases.

EXPLANATION OF SOME PARAMETERS:

Earth Return Correction: Controls the number of correction terms in Carson's earth-return formula for the impedances (see also p. 45).

"1" in col. 28: Normally used (gives highest accuracy). Use always, unless certain effects are desired.

"0": No correction term added (amounts to zero earth resistivity).

≥ 1 : As many correction terms are added as specified by this value (rounded to nearest integer), but not more than 31 if $a \leq 5$ (see p. 46). For $a > 5$, eq. (35) of p. 46 is used.

< 1 : As many correction terms are added as are necessary to get two successive correction terms (in cgs units/cm as defined by Carson) smaller in magnitude than this value if $a \leq 5$. For $a > 5$ eq. (35) is used. Note that the magnitude of the correction terms is < 0.4 cgs-units/cm for resistance and usually of the order 1.0 for reactance. Therefore, "1" in col. 28 yields the highest accuracy of 10^{-6} and does not cost noticeable computer time.

blank: Automatically set to 10^{-6} (is equivalent to "1" in col. 28).

Enter "1" To Get. . .: Note that all output options (columns 30-35, 37-42 and 54-57) are independent of one another. Meaning of these matrices is explained on p. 13.

Capacitance Option:

0 or blank = all matrices indicated in col. 30-35 will be susceptance matrices (ωC) or their inverses.

1 = all matrices indicated in col. 30-35 will be capacitance matrices or their inverses.

Columns 54 to 57: The admittance and/or impedance matrices will be the shunt admittance (impedance) matrix and the transfer admittance (impedance) matrix of the equivalent multiphase π -circuit for the untransposed line.

Ground Wire Segmentation:

0 or blank = Normal

1 = Segmented ground wires (interrupted at certain intervals). Since segmented ground wires cannot carry any current if wave length \gg length of segmentation interval, it is felt that the segmentation is best handled by ignoring the ground wires in computing the series impedance matrices and by taking them into account in computing the shunt capacitance matrices. This technique is activated by "1" in col. 58. Note that this approach may not be valid at higher frequencies.

Parameters for Special Outputs:

See P. 17 for getting mutual impedance between a power circuit and a communication line.

See P. 18 for getting the frequency-dependence of zero and positive sequence parameters.

SYMMETRICAL COMPONENTS:

Symmetrical component matrices are normally * computed with the assumption that the circuits are three-phase circuits. The well-known transformations are used (a,b,c = phase quantities):

$$\begin{bmatrix} V_{\text{zero}} \\ V_{\text{positive}} \\ V_{\text{negative}} \end{bmatrix} = k_1 \begin{bmatrix} 1 & 1 & 1 \\ 1 & a & a^2 \\ 1 & a^2 & a \end{bmatrix} \begin{bmatrix} V_a \\ V_b \\ V_c \end{bmatrix} \quad \text{identical for currents}$$

$$\text{and } \begin{bmatrix} V_a \\ V_b \\ V_c \end{bmatrix} = k_2 \begin{bmatrix} 1 & 1 & 1 \\ 1 & a^2 & a \\ 1 & a & a^2 \end{bmatrix} \begin{bmatrix} V_{\text{zero}} \\ V_{\text{positive}} \\ V_{\text{negative}} \end{bmatrix}$$

with $a = e^{i120^\circ}$ and $k_1 \cdot k_2 = \frac{1}{3}$ (usually $k_1 = \frac{1}{3}$, $k_2 = 1$; for normalized components: $k_1 = \frac{1}{\sqrt{3}}$, $k_2 = \frac{1}{\sqrt{3}}$).

*Exception: 2-phase circuit (see next page)

Example: If the number of phases (= equivalent phase conductors) is 6, then it is assumed that no. 1, 2, 3 form the first three-phase circuit and no. 4, 5, 6 form the second three-phase circuit. The symmetrical components will be those of each circuit and the coupling between them.* If the number of phases were 7, then the seventh equivalent phase conductor would be ignored as non-existent in computing symmetrical components.

For two-phase circuits with two phases (example: DC intertie) the symmetrical components are based on the following transformation:

$$\begin{aligned} V_{\text{zero}} &= k_1(V_a + V_b) \\ V_{\text{positive}} &= k_1(V_a - V_b) \quad , \text{ identical for currents,} \end{aligned}$$

and

$$\begin{aligned} V_a &= k_2(V_{\text{zero}} + V_{\text{positive}}) \\ V_b &= k_2(V_{\text{zero}} - V_{\text{positive}}) \end{aligned}$$

with

$k_1 k_2 = \frac{1}{2}$ (usually: $k_1 = \frac{1}{2}$, $k_2 = 1$; for normalized components:

$$k_1 = \frac{1}{\sqrt{2}}, k_2 = \frac{1}{\sqrt{2}})$$

* The results are valid for the given tower configuration with the assumption that the line is untransposed. For transposed single circuits simply ignore the coupling between sequence quantities (see p. 29). There is no simple answer for transposed double circuit lines, except that coupling always exists in the zero sequence with the correct values shown in the 6 x 6 matrix. The transposition scheme on p. 47 has no positive sequence coupling; therefore, simply take the positive sequence values of each circuit and ignore the coupling in the 6 x 6 matrix (or, if both circuits are identical, the impedance of the circuits in parallel is simply one half of the impedance of one circuit). On the other hand, the transposition scheme on p. 49 has positive sequence coupling and the impedance of the circuits in parallel is no longer simply one half of the impedance of one circuit. More details on these and other transposition schemes can be found in a note "Preliminary Conclusions on Influence of Transposition Schemes on Positive Sequence Values" dated 10/20/72. Since this note gives only preliminary results, more work may be required.

If the user punches a "1" in col. 35 as well as in col. 39, then the computer will also print surge impedance, attenuation, wave velocity and wave length for zero and positive sequence (for the first three-phase circuit only if there are more than one three-phase circuit), as well as series impedance and shunt admittance per mile.

TRANSPPOSED VERSUS UNTRANSPPOSED LINE

The line constants are computed for the true tower configuration, which is always untransposed. When the line is transposed, the series impedance matrix per-unit length is traditionally obtained from the arithmetic average of the impedance matrices of the individual transposition sections (analogous for shunt admittance matrix). This "theoretical transposition" is an approximation; the exact results would be obtained from a series connection of the untransposed equivalent multi- π 's of the individual transposition sections (however, the symmetrical component impedances would have some coupling in the latter case).

For practical purposes the assumption of theoretical transposition is imperative if the sequence impedances should be decoupled. It can be shown that the sequence impedances obtained from the program for the untransposed line are equal to those of theoretical transposition if the coupling terms are simply ignored. A more detailed 10-page note on this problem is available from Dr. H. W. Dommel.

CHANGE CASE

Normally, each DATA DECK defines a new case. However, the CHANGE option permits changes in the conductor data of a preceding DATA DECK. The DATA DECK of the CHANGE option is set up as follows:

1. One alphanumeric card with the word "CHANGE" in the first 6 columns.
2. Conductor cards in any order, terminated by a BLANK card. These cards are interpreted as additions, deletions or changes in the conductor list of the preceding DATA DECK (of the same run), with the following rules:
 - a. If the conductor name (col. 73-78) can be found in the conductor list (established from preceding DATA DECK with modifications already made), then the parameters on this card replace the old values in the list ("changes"). Changes only apply to the first 6 fields on the card. The conductor name and location cannot be changed. To change the location of a conductor, the conductor must be deleted and a new conductor entered. Of the first 6 fields, only those which are punched will be changed. Fields left blank will keep the variables unchanged. A conductor can be removed from the list by reading in a new conductor card with identical conductor name and a phase number <0 ("deletions").
 - b. If the conductor name cannot be found in the conductor list, then the new conductor is added to the list ("additions"). In this case, all data must be punched.
3. Any number of frequency cards, terminated by a BLANK card.

Form of Output for LINE CONSTANTS

The output should be more or less self-explanatory. Additional remarks have been written into the attached sample output sheets.

(a) Listing of Conductor Cards

The information contained on the conductor cards of the input data deck is printed for the record in its original form, with the exception of height at tower and midspan. Instead, the averaged height is listed as Y-coordinate. The order of the conductor cards in the input data deck is arbitrary; the order in the listing will always be:

Conductors first encountered with phase numbers 1, 2, 3,, followed by conductors with identical phase numbers (= 2nd, 3rd, 4th, . . . conductors in 2-, 3-, 4-conductor-bundles), followed by ground wires (phase number = "0").

(b) Line Constants

Since all matrices are symmetric, only values in and below the diagonal are printed:

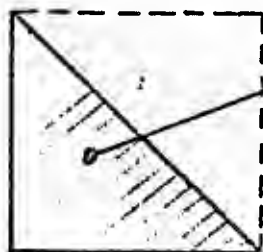

this "lower triangular" matrix is printed only.

All matrices, except the susceptance (or capacitance) matrices for the physical and equivalent conductors, are complex. Real and imaginary parts are printed right above each other:

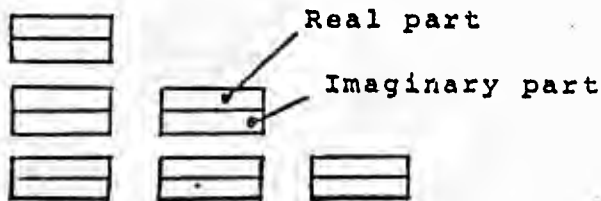

The matrix elements of the impedance matrices per mile are defined as follows:

$$Z'_{i,k} = \text{mutual impedance between } i \text{ and } k,$$

$$Z'_{i,i} = \text{self impedance of } i.$$

The matrix elements of the susceptance (or capacitance) matrices per mile are defined as follows:

$$\omega C'_{i,k} = \text{negative value of susceptance between } i \text{ and } k,$$

$$\omega C'_{i,i} = \text{sum of all susceptances from } i \text{ to all other conductors and to ground.}$$

Note that the matrices for symmetrical components have the rows ordered in the sequence "zero (0), positive (1), negative (2) of 1st circuit, (0), (1), (2) of 2nd circuit etc.", whereas the columns have (1) and (2) exchanged and are thus ordered "(0), (2), (1) of 1st circuit, (0), (2), (1) of 2nd circuit etc.". This makes these matrices symmetric:

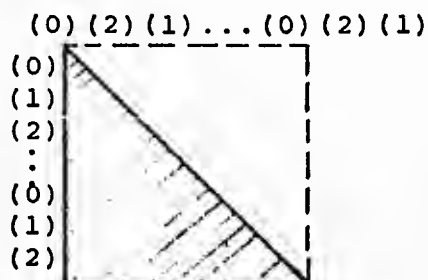

From this row-and column numbering it follows that

$$Z'_{1,1} = Z'_{2,2} \text{ within any 3-phase circuit}$$

$$Z'_{1,0} = Z'_{0,2} \text{ within any 3-phase circuit}$$

etc.

If the line is transposed, then assume all couplings between sequences to be zero, except between zero sequences of parallel circuits (see section 5). Note that the capacitive couplings between sequences of the untransposed lines are complex (this is why the susceptance or capacitance matrices per mile for symmetrical components are printed complex with an imaginary part which is zero in terms that do not couple sequences).

If the user asks for the susceptance (or capacitance) and impedance matrices per mile for symmetrical components, then additional sequence parameters are printed for the first 3-phase circuit (see attached output sheets). This output is primarily intended for single 3-phase and 2-phase circuits.

TEST EXAMPLE FROM M. H. HESSE, TRANS. AIEE III VOL. 021(1963), PAGE 283. JAN-22-65

RECORD OF SCHEDULED INPUT DATA

PHASE NUMBER	R-TYPE	RESISTANCE	X-TYPE	R OR C	CMR DIAMETER	X-COORD.	Y-COORD.	NAME
1	1	-0.	0.06570	1	0.36500	1.46500	7.900	PH-A 1
2	2	-0.	0.06570	1	0.36500	1.46500	0.	PH-B 1
3	1	-0.	0.06570	1	0.36500	1.46500	7.000	PH-C 1
4	4	-0.	0.06570	1	0.36500	1.46500	50.000	PH-A 2
5	5	-0.	0.06570	1	0.36500	1.46500	87.000	PH-B 2
6	6	-0.	0.06570	1	0.36500	1.46500	86.000	PH-C 2
7	1	-0.	0.06570	1	0.36500	1.46500	8.500	AU 7
8	2	-0.	0.06570	1	0.36500	1.46500	1.500	AU 8
9	3	-0.	0.06570	1	0.36500	1.46500	8.500	AU 9
10	6	-0.	0.06570	1	0.36500	1.46500	58.500	NU10
11	5	-0.	0.06570	1	0.36500	1.46500	65.500	NU11
12	4	-0.	0.06570	1	0.36500	1.46500	58.500	NU12
13	0	-0.	0.58800	1	0.48400	0.57700	2.000	NU13
14	0	-0.	0.58800	1	0.48400	0.57700	65.000	NU14

FOLLOWING MATRICES ARE FOR EARTH RESISTIVITY= 100.00 OHM-M AND FREQUENCY= 60.00 HZ. CORRECTION FACTOR= 0.00001

SUSCEPTANCE MATRIX (MH/MILE) FOR THE SYSTEM OF EQUIVALENT PHASE CONDUCTORS
ROWS AND COLUMNS PROCEED IN SAME ORDER AS SORTED INPUT

1	0.61898E-05							
2	-0.10908E-05	0.61368E-05						
3	-0.33335E-06	-0.10287E-05	0.62730E-05					
4	-0.67823E-06	-0.38310E-06	-0.14288E-06	0.61898E-05				
5	-0.38310E-06	-0.19163E-06	-0.32754E-06	-0.10908E-05	0.61368E-05			
6	-0.14287E-06	-0.32754E-06	-0.53641E-06	-0.33335E-06	-0.10287E-05	0.62730E-05		

negative value of susceptance between 4th & 2nd equiv. conductors ($\omega C_{4,2} = 0.3831 \mu\text{mho/mile}$)

sum of all susceptances from 5th equiv. conductor to all other equiv. conductors and to ground of earth wires (see FIG.)

SUSCEPTANCE MATRIX (MH/MILE) FOR THE SYMMETRICAL COMPONENTS OF THE EQUIVALENT PHASE CONDUCTORS
ROWS PROCEED IN SEQUENCE 0, 1, 2, 0, 1, 2 ETC. AND COLUMNS PROCEED IN SEQUENCE 0, 2, 1, 0, 2, 1 ETC.

0	0.45846E-05							
1	0.10050E-06	-0.21615E-06						
2	0.10050E-06	0.70175E-05	-0.21615E-06					
0	-0.11423E-05	-0.58853E-07	-0.58253E-07	0.45846E-05				
1	-0.1853E-07	-0.45499E-07	-0.23298E-06	0.10050E-06	-0.21615E-06			
2	-0.58853E-07	-0.23298E-06	-0.95499E-07	0.10050E-06	0.70175E-05	-0.21615E-06		

Zero-sequence susceptance of 1st 3-phase-circuit (phase # 1,2,3)

positive-seq. susceptance

Zero-sequence susceptance of 2nd 3-phase-circuit (phase # 4,5,6)

positive-seq.

negative value of zero-seq. & pos-seq. susceptance between 1st and 2nd circuit

IMPEDANCE MATRIX (OHM/MILE) FOR THE SYSTEM OF EQUIVALENT PHASE CONDUCTORS
ROWS AND COLUMNS PROCEED IN SAME ORDER AS SORTED INPUT

1	0.14025E 00							
2	0.96591E-01	0.12244E 00						
3	0.91076E-01	0.40064E-01	0.11647E 00					
4	0.94802E-01	0.21452E 00	0.87886E-01	0.14025E 00				
5	0.93536E-01	0.88318E-01	0.25214E 00	0.96591E-01	0.12244E 00			
6	0.84866E-01	0.45538E-01	0.31805E 00	0.91076E-01	0.40064E-01	0.11647E 00		

mutual impedance between 4th & 3rd equiv. conductors ($Z_{4,3} = 0.087866 + j 0.20545 \Omega/\text{mile}$)

self impedance of 3th equiv. conductor

IMPEDANCE MATRIX (OHM/MILE) FOR THE SYMMETRICAL COMPONENTS OF THE EQUIVALENT PHASE CONDUCTORS
ROWS PROCEED IN SEQUENCE 0, 1, 2, 0, 1, 2 ETC. AND COLUMNS PROCEED IN SEQUENCE 0, 2, 1, 0, 2, 1 ETC.

0	0.30887E 00							
1	0.32497E-02	-0.92372E-01						
2	0.15197E-01	0.35143E-01	0.45802E-01					

zero-sequence impedance of 1st circuit

Special Output for Mutual Impedance Between a
3-Phase Circuit and a Communication Line

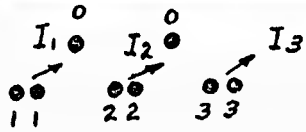

Currents in a three-phase circuit induce a longitudinal voltage in the communication line no. 4. (the three-phase circuit may have bundle conductors and earth wires). The induced voltage is

$$\Delta V_4 = Z'_{41} I_1 + Z'_{42} I_2 + Z'_{43} I_3 \quad (1)$$

If the phase currents are transformed to un-normalized sequence quantities (see p. 28),

$$\begin{bmatrix} I_{\text{zero}} \\ I_{\text{positive}} \\ I_{\text{negative}} \end{bmatrix} = \frac{1}{3} \begin{bmatrix} 1 & 1 & 1 \\ 1 & a & a^2 \\ 1 & a^2 & a \end{bmatrix} \begin{bmatrix} I_1 \\ I_2 \\ I_3 \end{bmatrix}, \text{ with } a = e^{j120^\circ} \quad (2)$$

$$\text{then } \Delta V_4 = Z'_{\text{zero}/4} \cdot I_{\text{zero}} + Z'_{\text{positive}/4} \cdot I_{\text{positive}} + Z'_{\text{negative}/4} \cdot I_{\text{negative}} \quad (3a)$$

$$\text{with } \begin{cases} Z'_{\text{zero}/4} = Z'_{41} + Z'_{42} + Z'_{43} \\ Z'_{\text{positive}/4} = Z'_{41} + a^2 Z'_{42} + a Z'_{43} \\ Z'_{\text{negative}/4} = Z'_{41} + a Z'_{42} + a^2 Z'_{43} \end{cases} \quad (3b)$$

The absolute values of these mutual impedances will be printed. Note that these values would have to be multiplied $\frac{\sqrt{3}}{3}$

if normalized sequence quantities were used.

How to Obtain Special Output:

FORMAT OF SPECIAL OUTPUT:

Mutual Impedance	Positive = .00008 ohm/mile
	Negative = .00007 ohm/mile
	Zero = .0209 ohm/mile

- (1) The phases must be numbered 1, 2, 3 (bundles and earth wires permitted); the communication line must be no. 4.
- (2) Punch "1" in column 59 of the frequency card.

The mutual impedances of eq. (3b) as well as the impedance matrix for the equivalent phase conductors are printed, in addition to any other output requested. If the number of equivalent phase conductors is unequal 4, then the special output is skipped (all other requested output will still be correct) and the following message is printed:

SPECIAL OUTPUT FOR MUTUALS NOT APPLICABLE TO THIS CASE

Special Output for Frequency Dependence of Zero and Positive
Sequence Parameters

Use this option to get the zero and positive sequence parameters per unit length as a function of frequency.

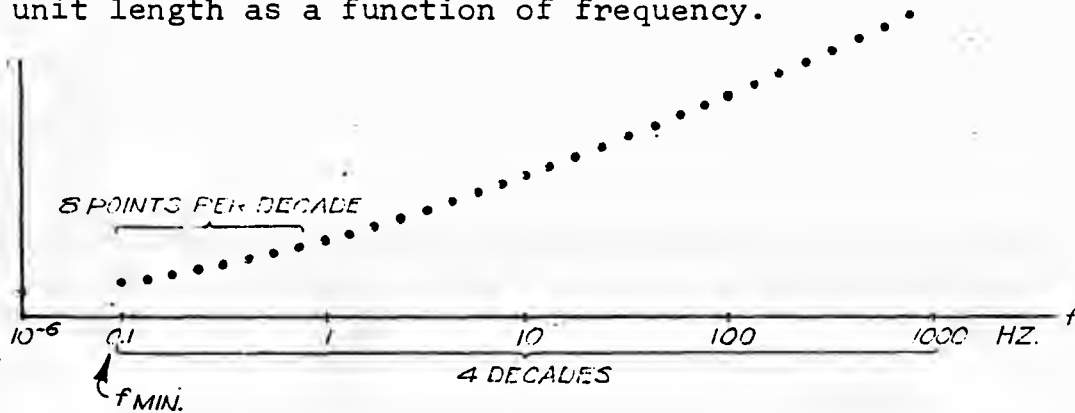

The values are computed at equidistant points on a logarithmic frequency scale, with $f = 0$ approximated by 10^{-6} Hz. Punch

f_{\min} in col. 9-18

no. of decades in col. 60-62

no. of points per decade in col. 63-65

IPUNCH in col. 66-68 ** (not yet available)

} on the
frequency
card

Earth resistivity (col. 1-8), earth return correction (col. 19-28), ground wire segmentation (col. 58), and the output options in columns 30-35, 37-42, and 54-57 retain their meaning as for the conventional, single-frequency case. All other parameters on the frequency card are ignored. To obtain a nice table output (of zero and positive-sequence parameters as a function of frequency), however, leave columns 30-35 and 37-42 blank; otherwise, the requested matrices will be printed between the lines of the table output.

IPUNCH = 0 or blank: The program will print the parameters α (neper/mile), β (radian/mile), R (Ω /mile), L (mH/mile) and C (μ F/mile) for zero and positive sequence as a function of frequency.

IPUNCH > 0: In addition to printing, the parameters α_0 , β_0 , (zero sequence), α_1 , β_1 (positive sequence) and f (Hz) are also punched on cards with the format 5E15.5.

These cards are intended to be used as input for transients programs which can handle the frequency dependence. At this time, only the FOURIER TRANSFORMATION program can accept the frequency dependence (directly in the form of these cards).

II PROGRAM DESCRIPTION

1. INTRODUCTION

The line parameters of overhead transmission lines are necessary input data for more or less detailed studies of transmission line phenomena. The simplest constants are the series impedance and shunt capacitance for the positive sequence as used in power flow studies. These are usually available from tables. Often more detailed line parameters, not available from tables, are needed. Examples can be grouped according to the nature of the phenomena:

- (a) Steady-state problems at power frequency. As examples, one may want to study the current and voltage dissymmetry on a long, untransposed line or the unequal current distribution among the individual conductors of a bundle conductor. Another example is the investigation of induced voltages and currents in a de-energized line running parallel with an energized line (very important for the safety of maintenance crews).
- (b) Steady-state problems at higher frequencies. Typical studies are interference in neighboring communication lines, propagation of harmonics on an HVDC line and carrier communication on power lines.
- (c) Transients problems. Typical studies are switching surges and lightning surges and means of reducing them with protective gaps, lightning arresters, insertion of resistors in circuit breakers etc.

Line parameters could be measured after the line has been built. However, some of them are already needed in the design stage; therefore, they must be computed beforehand. Even after the line has been built, it is easier to compute the parameters with sufficient accuracy.

The following notes explain the basic formulas used in the digital computation of line parameters. Computer programs should be as general as possible, that is they should allow for any number of conductors of which some may be bundled and others grounded, and for any frequency and ground resistivity. The theory for such programs is scattered in many papers and is seldom found in textbooks because most of them are still geared to hand computations with special formulas for each particular case. A good summary is the paper by M.H. Hesse [2].

2. LINE PARAMETERS FOR PHYSICAL CONDUCTORS

Fig.1 shows the tower configuration of two parallel three-phase circuits with twin bundle conductors and one ground wire. There are 13 conductors in this configuration. They will be called physical conductors to distinguish them from the 6 equivalent phase conductors which are obtained after pairs have been bundled into phase conductors and after the ground wire has been eliminated from the associated equations.

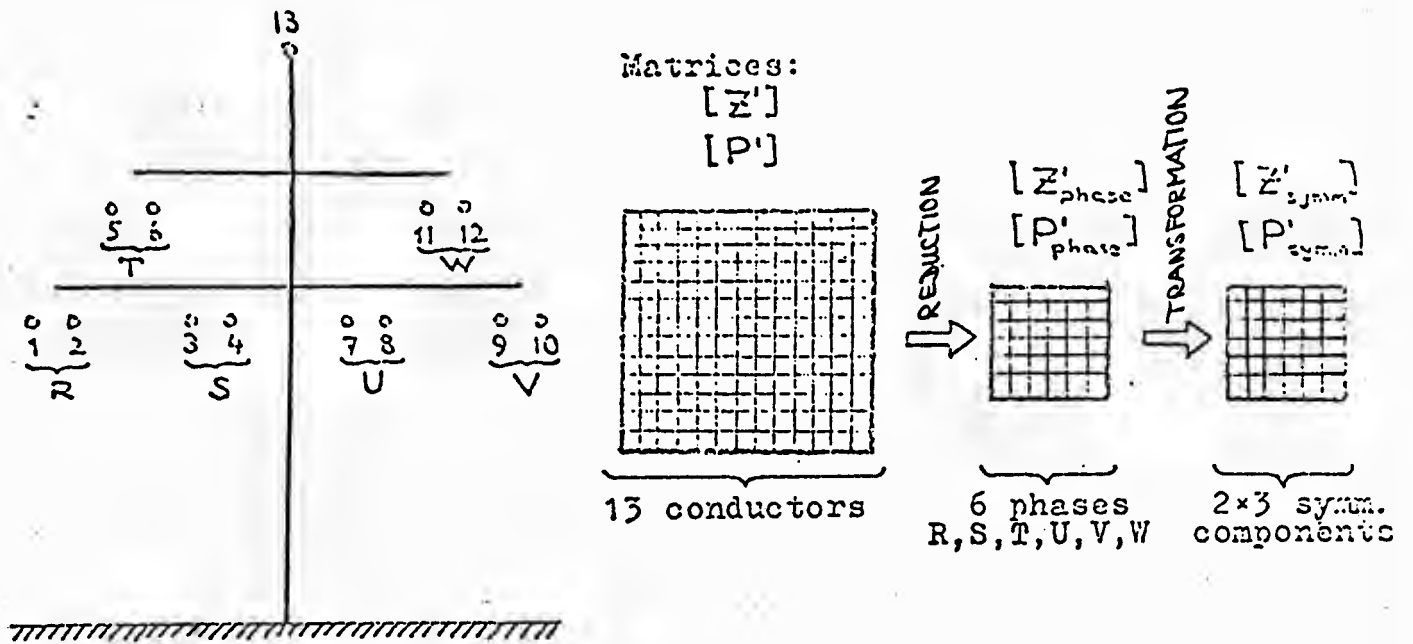

Fig.1 Line parameters

2.1 Series impedance

The voltage drop along these 13 conductors is a function of the currents. For ac steady-state conditions, phasors can be used to express this voltage drop (negative sign on left hand indicates drop): *

$$- \begin{bmatrix} \frac{dV_1}{dx} \\ \frac{dV_2}{dx} \\ \vdots \\ \frac{dV_{13}}{dx} \end{bmatrix} = \begin{bmatrix} Z'_{11} & Z'_{12} & \dots & Z'_{1,13} \\ Z'_{21} & Z'_{22} & \dots & Z'_{2,13} \\ \dots & \dots & \dots & \dots \\ Z'_{13,1} & Z'_{13,2} & \dots & Z'_{13,13} \end{bmatrix} \begin{bmatrix} I_1 \\ I_2 \\ \vdots \\ I_{13} \end{bmatrix} \quad (1a)$$

with V_i = voltage (phasor) from conductor i to ground,
 I_i = current (phasor) in conductor i ,

or in the general case

$$- \left[\frac{dV}{dx} \right] = [Z'] [I] \quad (1b)$$

with $[V]$ = vector of conductor voltages,
 $[I]$ = vector of conductor currents.

$[Z'] = [R'] + j\omega [L']$ is called the series impedance matrix; it is complex and symmetric. The diagonal element $Z'_{ii} = R'_{ii} + j\omega L'_{ii}$ is the series self impedance per unit length of the loop formed by conductor i and ground

*) Primed letters are used to indicate quantities per unit length. Brackets are used to indicate matrices and vectors.

return. The off-diagonal element $Z'_{ik} = Z'_{ki} = R'_{ki} + j\omega L'_{ki}$ is the series mutual impedance per unit length between conductors i and k . It may be surprising to find resistive terms in the mutual coupling. They are introduced by the presence of ground and describe the phase shift which takes place in the coupling. All elements are calculated with Carson's formula, which assumes that the earth has uniform conductivity and is bounded by a flat plane with infinite extent. The details are explained in appendix 1a. The formulas in most textbooks are derived from Carson's work by retaining only the first one or two terms in an infinite series. This is acceptable at power frequency and for normal conductor spacings. At higher frequencies and for wider spacings, however, (e.g., in interference calculations) these formulas would produce very severe errors. Therefore, a general purpose program must have a provision to use many more terms in the infinite series. This is also explained in appendix 1a.

The elements of the series impedance matrix are computed from the geometry of the tower configuration and from certain characteristics of the conductors (resistance and internal inductance or geometric mean radius). Conductor resistance and internal inductance change with frequency due to skin effect. Therefore, a formula for skin effect correction is needed. Appendix 2 explains the skin effect formula for tubular conductors, which also covers the solid conductor, with a detailed description of the subroutine SKIN. Stranded conductors can be approximated by a solid conductor of identical cross-section. Steel-reinforced aluminum cables could be handled as tubular conductors with the steel core ignored. Note, however, that these approximations may not be valid at high frequencies where more accurate formulas may be needed. A case study of this problem is shown in appendix 3.

2.2 Shunt capacitance

The voltages of the 13 conductors (measured to ground) are a function of the line charges. For ac steady state conditions the relationship is

$$\begin{bmatrix} V_1 \\ V_2 \\ \vdots \\ V_{13} \end{bmatrix} = \begin{bmatrix} P'_{11} & P'_{12} & \dots & P'_{1,13} \\ P'_{21} & P'_{22} & \dots & P'_{2,13} \\ \dots & \dots & \dots & \dots \\ P'_{13,1} & P'_{13,2} & \dots & P'_{13,13} \end{bmatrix} \begin{bmatrix} Q_1 \\ Q_2 \\ \vdots \\ Q_{13} \end{bmatrix} \quad (2a)$$

with Q_i = charge (phasor) on conductor per unit length,

or in the general case

$$[V] = [P'] [Q] \quad (2b)$$

The elements of Maxwell's potential coefficient matrix $[P']$ are computed from the geometry of the tower configuration and the conductor radii as explained in appendix 1b. The matrix $[P']$ is symmetric and real. The inverse relationship

$$[Q] = [C'] [V] \quad (3)$$

uses the capacitance matrix, which is the inverse of the potential coefficient matrix:

$$[C'] = [P']^{-1} \quad (4)$$

A suitable inversion technique is the Gauss-Jordan process for matrix inversion with advantage taken of the symmetry [3]. This process can easily be modified to handle matrix reductions as well, which is needed later for eliminating ground wires and for bundling conductors. Appendix 4 describes the subroutine for matrix reduction or inversion.

The capacitance matrix $[C']$ is in nodal form. This means that the diagonal element C'_{ii} is the sum of the shunt capacitances per unit length between conductor i and all other conductors and ground, the off-diagonal element $C'_{ik} = C'_{ki}$ is the negative shunt capacitance per unit length between conductors i and k . Example for a 3-phase circuit [6]:

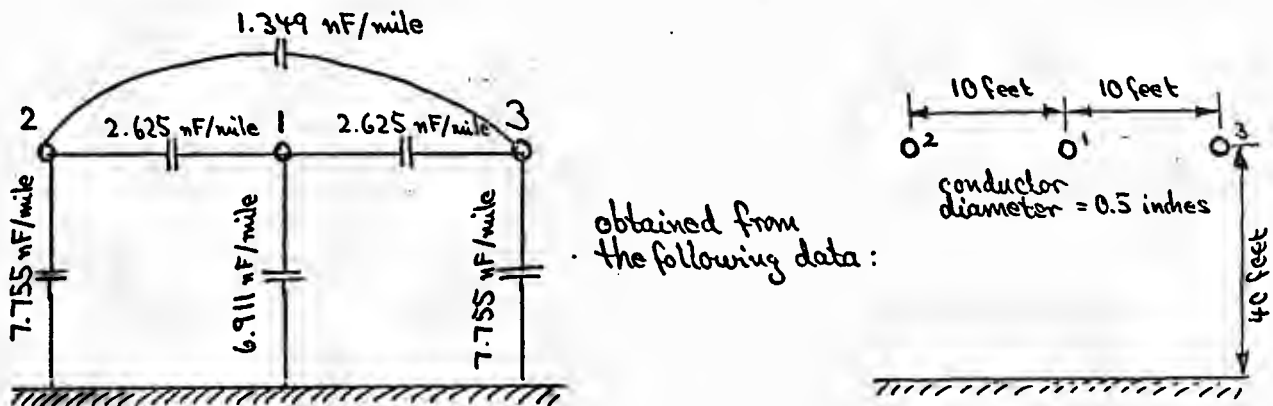

$$[C'] = \begin{bmatrix} 1.2161 & -0.2625 & -0.2625 \\ -0.2625 & 1.1729 & -0.1349 \\ -0.2625 & -0.1349 & 1.1729 \end{bmatrix} \cdot 10^{-8} \text{ F/mile}$$

For steady state conditions, the vector of charges (as phasors) is related to the vector of leakage currents $[-\frac{dI}{dx}]$ by

$$[Q] = -\frac{1}{j\omega} \left[\frac{dI}{dx} \right] \quad (5)$$

Therefore, the second system of differential equations is

$$-\left[\frac{dI}{dx} \right] = j\omega [C'] [V] \quad (6)$$

The matrices for all physical conductors are an ideal tool for studying unbalanced current distribution in bundle conductors [21].

3. ELIMINATION OF GROUND WIRES AND BUNDLING OF CONDUCTORS

The equations (1a) and (2a) for all 13 conductors contain more information than is usually wanted. Generally, only the phase quantities are of interest (in Fig. 1 phases R,S,T and U,V,W). The transition from two systems with 13 equations to those with 6 equations for the phase quantities is accomplished by introducing the terminal conditions, in Fig. 1,

for grounding 13: $\frac{dV_{13}}{dx} = 0$ in (1), $V_{13} = 0$ in (2),

for bundling 1,2 into phase R: $I_1 + I_2 = I_R$, $\frac{dV_1}{dx} = \frac{dV_2}{dx} = \frac{dV_R}{dx}$ in (1), and $Q_1 + Q_2 = Q_R$, $V_1 = V_2 = V_R$ in (2),

etc. The reduced matrices (in Fig. 1, 6 x 6 matrices) are often called matrices for the equivalent phase conductors.

3.1 Bundling of conductors

The mathematical process which reflects bundling is analogous for the system of equations (1) and (2). Therefore, it will only be shown for eq. (1). Let us assume that conductors i,k,l,m are to be bundled to form phase R. Then the terminal conditions

$$I_i + I_k + I_l + I_m = I_R$$

and $\frac{dV_i}{dx} = \frac{dV_k}{dx} = \frac{dV_l}{dx} = \frac{dV_m}{dx} = \frac{dV_R}{dx}$

must be introduced into (1). The first step is to get I_R into the equations. This is done by writing I_R in place of I_i . By doing this, terms of the form

$$Z'_{\mu i} (I_k + I_l + I_m)$$

are added in any one row μ ; they must be subtracted again to keep the equations valid. In effect, this means subtraction of column i from columns k,l,m. The changes are indicated by shading:

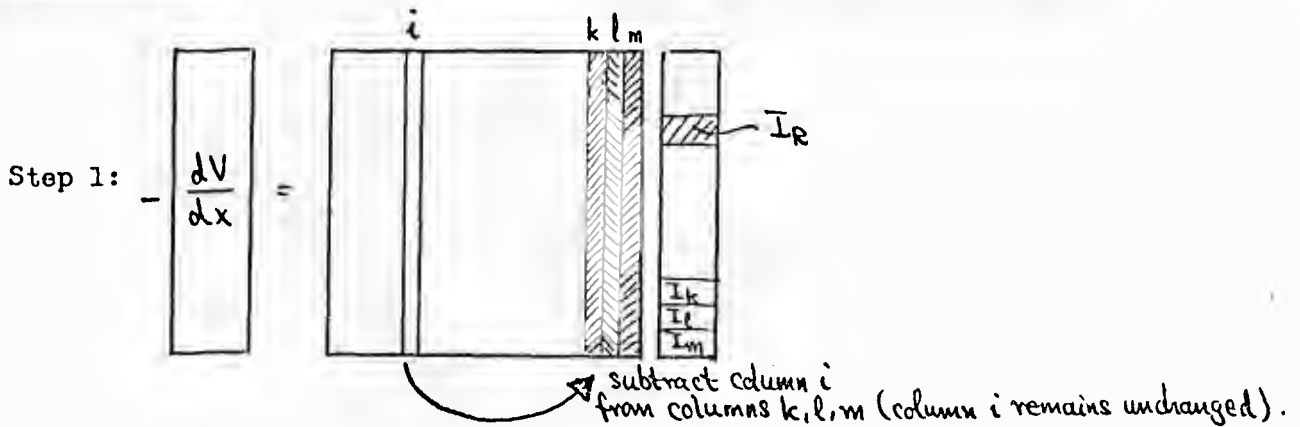

Columns k, l, m are assumed to be the last ones in the matrix to make the explanation easier. The currents I_k, I_l, I_m are still in the equations. To eliminate them, there should be zeros in the respective rows of the

left hand side. This is accomplished by subtracting row i from rows k, l, m.
 Zero is produced because $\frac{dV_i}{dx} = \frac{dV_a}{dx}$

etc. Again, the changes are indicated by shading:

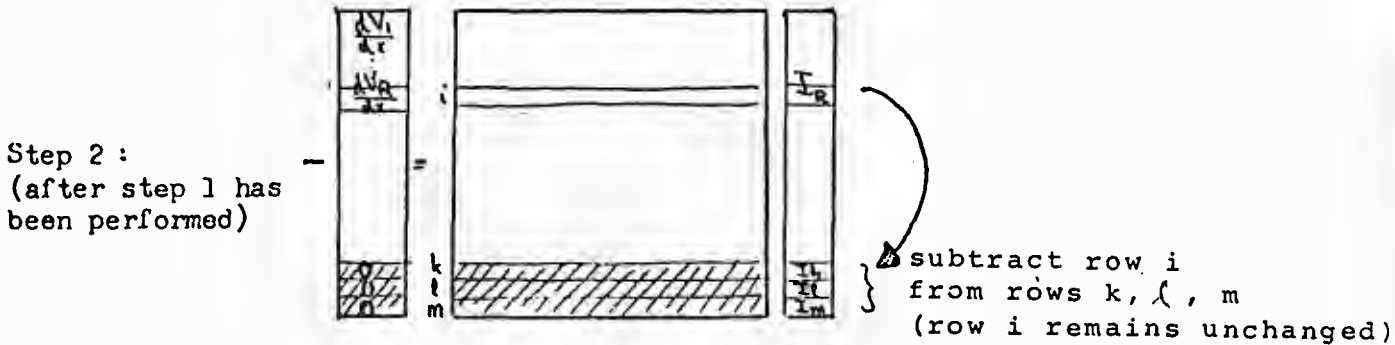

The equations are now in a form which permits elimination of I_k, I_l, I_m as explained in appendix 4.

3.2 Elimination of ground wires

Again, the mathematical process is analogous for the system of eq. (1) and (2) so that it suffices to show it for eq. (1) only. Let us assume that conductor j is a ground wire. In contrast to bundling, no preparatory work is necessary for elimination of ground wires because the matrix already has the form required for elimination (left hand side $\frac{dV_j}{dx} = 0$).

The assumption $\frac{dV_j}{dx} = 0$ is correct as long as the ground wire is grounded at distances much shorter than the wave length so that no potential can build up in the wires. At power frequency this assumption is always true. At very high frequencies, e.g. in lightning surge studies, this may not be true any more. In such cases the ground wires should not be eliminated.

3.3 Reduced system for equivalent phase conductors

When step 2 of section 3.1 has been completed for all bundle conductors and when all ground wires and second, third, ... conductors of bundles have been placed in the last rows and columns, then the equations will have the form

$$\begin{bmatrix} -\left[\frac{dV_{\text{phase}}}{dx}\right] \\ \dots \\ 0 \end{bmatrix} = \begin{bmatrix} [Z'_{\text{phase,phase}}] & [Z'_{\text{phase,rest}}] \\ \dots \\ [Z'_{\text{rest,phase}}] & [Z'_{\text{rest,rest}}] \end{bmatrix} \begin{bmatrix} [I_{\text{phase}}] \\ \dots \\ [I_{\text{rest}}] \end{bmatrix}$$

} non-bundled conductors and first conductor in each bundle
 } rest of conductors (ground wires, plus second, third, ... conductor in each bundle).

After eliminating $[I_{rest}]$ as explained in appendix 4, the reduced system for the equivalent phase conductors

$$-\left[\frac{dV_{phase}}{dx}\right] = [Z'_{phase}][I_{phase}] \quad (7)$$

is obtained, with $[Z'_{phase}] = [Z'_{phase,phase}] - [Z'_{phase,rest}][Z'_{rest,rest}]^{-1}[Z'_{rest,phase}]$.

For Fig. 1, this process reduces the 13 x 13 matrix for the physical conductors to a 6 x 6 matrix for the phases. In this example, the phase equations would be:

$$-\frac{d}{dx} \begin{bmatrix} V_R \\ V_S \\ V_T \\ V_U \\ V_V \\ V_W \end{bmatrix} = \begin{bmatrix} Z'_{RR} & Z'_{RS} & Z'_{RT} & Z'_{RU} & Z'_{RV} & Z'_{RW} \\ Z'_{SR} & Z'_{SS} & Z'_{ST} & Z'_{SU} & Z'_{SV} & Z'_{SW} \\ Z'_{TR} & Z'_{TS} & Z'_{TT} & Z'_{TU} & Z'_{TV} & Z'_{TW} \\ Z'_{UR} & Z'_{US} & Z'_{UT} & Z'_{UU} & Z'_{UV} & Z'_{UW} \\ Z'_{VR} & Z'_{VS} & Z'_{VT} & Z'_{VU} & Z'_{VV} & Z'_{VW} \\ Z'_{WR} & Z'_{WS} & Z'_{WT} & Z'_{WU} & Z'_{WV} & Z'_{WW} \end{bmatrix} \begin{bmatrix} I_R \\ I_S \\ I_T \\ I_U \\ I_V \\ I_W \end{bmatrix}$$

For a three-phase single circuit with phases A,B,C, eq. (7) would have the form

$$-\begin{bmatrix} \frac{dV_A}{dx} \\ \frac{dV_B}{dx} \\ \frac{dV_C}{dx} \end{bmatrix} = \begin{bmatrix} Z'_{AA} & Z'_{AB} & Z'_{AC} \\ Z'_{BA} & Z'_{BB} & Z'_{BC} \\ Z'_{CA} & Z'_{CB} & Z'_{CC} \end{bmatrix} \begin{bmatrix} I_A \\ I_B \\ I_C \end{bmatrix}$$

The diagonal element Z'_{KK} is the series self impedance of phase K for the loop formed by phase K and ground return and the off-diagonal element Z'_{IK} is the series mutual impedance between phases I and K. The self impedance of phase K is not the positive sequence impedance. If we assume symmetric operation in a three-phase single circuit, then the currents are

$$I_B = a^2 I_A \quad \text{and} \quad I_C = a I_A \quad \text{with} \quad a = e^{j120^\circ}$$

This gives $-\frac{dV_A}{dx} = \underbrace{(Z'_{AA} + a^2 Z'_{AB} + a Z'_{AC})}_{Z_1} I_A \quad (8)$

where Z_1 is the positive sequence impedance describing the normal symmetric operation of phase A. Eq. (8) is the single-phase representation of symmetric three-phase operation.

All derivations in sections 3.1 to 3.3 were carried out for eq. (1). As already mentioned, analogous derivations must be carried out for eq. (2) with the following correspondence:

[V] in (2) takes the place of $-\left[\frac{dV}{dx}\right]$ in (1),

[P'] in (2) takes the place of [Z'] in (1),

[Q] in (2) takes the place of [I] in (1).

Note that the process of bundling and ground wire elimination must be applied to [P'] rather than to [C']. If the capacitance matrix for the phases [C'_{phase}] is desired, one finds [P'_{phase}] first and then inverts this smaller matrix.

The reduced matrices for the phases are an ideal tool for studying unbalances in the phases if the line is not transposed, at power frequency as well as for switching surges.

4. INDEPENDENT MODES

In what follows it is assumed that the line is not transposed or that the length of a transposition cycle is not much shorter than the wave length. This is always true at high frequencies. Therefore, the following techniques are primarily used for radio frequency problems.

Currents and voltages in the phases at one frequency are related by two systems of differential equations,

$$-\left[\frac{dV_{\text{phase}}}{dx}\right] = [Z'_{\text{phase}}] \cdot [I_{\text{phase}}] \quad (9)$$

$$-\left[\frac{dI_{\text{phase}}}{dx}\right] = [Y'_{\text{phase}}] \cdot [V_{\text{phase}}] \quad (10)$$

$$\text{with } [Y'_{\text{phase}}] = j\omega [C'_{\text{phase}}]$$

It is customary to neglect shunt conductances due to leakage and corona so that the shunt admittance is equal to the shunt susceptance. Eq. (9) and (10) are valid for phasors as well as for the Fourier transforms if phenomena with many frequencies are studied.

By differentiating (9) with respect to x and inserting the result into (10) a second-order differential equation is obtained for the voltages only,

$$\left[\frac{d^2 V_{\text{phase}}}{dx^2}\right] = [Z'_{\text{phase}}] [j\omega C'_{\text{phase}}] [V_{\text{phase}}] \quad (11)$$

Similarly, a second system of equations is obtained for the currents,

$$\left[\frac{d^2 I_{\text{phase}}}{dx^2}\right] = [j\omega C'_{\text{phase}}] [Z'_{\text{phase}}] [I_{\text{phase}}] \quad (12)$$

Generally, the two matrix products $[Z'_{\text{phase}}][j\omega C'_{\text{phase}}]$ and $[j\omega C'_{\text{phase}}][Z'_{\text{phase}}]$ are different because multiplication in matrix algebra is not commutative.

Eq. (11) and (12) are difficult to solve because all phases are coupled, or mathematically, the matrix products have off-diagonal elements. It is possible, however, to transform the phase quantities into "modal" quantities $[V_{\text{mode}}]$ and $[I_{\text{mode}}]$ in such a way that the associated matrices are diagonal,

$$\left[\frac{d^2 V_{\text{mode}}}{dx^2} \right] = \underbrace{[\Lambda]}_{\text{diagonal matrix}} [V_{\text{mode}}] \quad (13)$$

In the mode domain the system of M equations breaks down into M independent (decoupled) equations. Each mode can then be solved in the same way as a single phase line. The phase quantities are changed to mode quantities and vice versa with a linear transformation. For the voltages this is

$$\begin{aligned} [V_{\text{phase}}] &= [S] [V_{\text{mode}}] \\ \text{and } [V_{\text{mode}}] &= [S]^{-1} [V_{\text{phase}}]. \end{aligned} \quad (14)$$

Then eq. (11) becomes

$$\left[\frac{d^2 V_{\text{mode}}}{dx^2} \right] = [S]^{-1} \left\{ [Z'_{\text{phase}}][j\omega C'_{\text{phase}}] \right\} [S] [V_{\text{mode}}] \quad (15)$$

$$\text{or } [\Lambda] = [S]^{-1} [Z'_{\text{phase}}][j\omega C'_{\text{phase}}][S]$$

To find the matrix $[S]$ which diagonalizes $[Z'_{\text{phase}}][j\omega C'_{\text{phase}}]$ is a fundamental problem in matrix algebra. There are standard techniques available for doing this. An efficient algorithm for finding the eigenvalues λ_i , which are the diagonal elements of $[\Lambda]$,

$$[\Lambda] = \begin{bmatrix} \lambda_1 & & & & \\ & \lambda_2 & & & \\ & & \lambda_3 & & \\ & & & \dots & \\ & & & & \lambda_M \end{bmatrix},$$

is the QR transformation due to Francis [8]. Once the eigenvalues are known, the matrix $[S]$ is found by solving the equations

$$\left([Z'_{\text{phase}}][j\omega C'_{\text{phase}}] - \begin{bmatrix} \lambda_i & & & \\ & \lambda_i & & \\ & & \dots & \\ & & & \lambda_i \end{bmatrix} \right) \cdot [s_i] = 0 \quad (16)$$

for $[s_i]$. These columns are called "eigenvectors"; they are identical with the columns of the transformation matrix $[S]$. Eq. (16) can usually be solved by setting one component of $[s_i]$ arbitrarily to 1.0 and solving for

the rest of the components. If this process does not work, then an efficient algorithm for finding the eigenvectors for given eigenvalues is the inverse iteration scheme due to Wilkinson [9]. The transformation matrix $[S]$ is not uniquely defined. Each column of it can be multiplied with a constant.

In general, a different transformation must be used for the currents:*

$$\begin{aligned} [I_{\text{phase}}] &= [T][I_{\text{mode}}] \\ \text{and} \quad [I_{\text{mode}}] &= [T]^{-1}[I_{\text{phase}}] \end{aligned} \quad (17)$$

because the matrix products in (11) and (12) have different eigenvectors. Their eigenvalues are identical, though. However, $[T]$ can easily be found from $[S]$ with

$$[T] = [C'_{\text{phase}}][S] \quad (18)$$

where $[T]$ would be unnormalized. It could be normalized by first adding the squares of all elements in a column and taking the square root of this sum,

$$d_k = \sqrt{\sum_{i=1}^M t_{ik}^2}, \quad \text{and then dividing each element in that column by } d_k.$$

If $[D] = \begin{bmatrix} d_1 & & & \\ & d_2 & & \\ & & d_3 & \dots \\ & & & \dots & d_M \end{bmatrix}$

then

$$[T]_{\text{normalized}} = [T] \cdot [D]^{-1} \quad (19)$$

It is easy to prove that $[T]$ from (18) does indeed diagonalize the matrix product in (12). First, recall that

$$[T]^{-1} = [S]^{-1}[C'_{\text{phase}}]^{-1}$$

Pre-multiplying $[j\omega C'_{\text{phase}}][Z'_{\text{phase}}]$ with $[T]^{-1}$ and post-multiplying with $[T]$ is seen to be equal to $[\Lambda]$ when compared against (15):

$$[S]^{-1} \underbrace{[C'_{\text{phase}}]^{-1}}_{= j\omega} [j\omega C'_{\text{phase}}] [Z'_{\text{phase}}] [C'_{\text{phase}}] [S] = [\Lambda]$$

The eigenvalues have a physical meaning. By taking any one mode from eq. (13), say

$$\frac{d^2 V_{\text{mode } i}}{dx^2} = \lambda_i V_{\text{mode } i}$$

and comparing it with the corresponding equation of a single phase line

*For this reason, it is generally not just a coordinate (or similarity) transformation.

which is

$$\frac{d^2 V}{dx^2} = \gamma^2 \cdot V$$

$$\text{with } \gamma^2 = (R' + j\omega L') j\omega C'$$

we see that the propagation constant γ_i of the independent mode must be

$$\gamma_i = \sqrt{\lambda_i} \quad (20)$$

with $\text{Re}\{\gamma_i\}$ = attenuation constant, e.g., in nepers/mile
 $\text{Im}\{\gamma_i\}$ = phase constant, e.g., in radians/mile

The surge impedance of a mode is not uniquely defined because the matrices $[S]$ and $[T]$ are not uniquely defined if they are not normalized. Let us recall that the surge impedance of a single phase line is defined by

$$Z_{\text{surge}} = \sqrt{\frac{R' + j\omega L'}{j\omega C'}}$$

To find the corresponding expression for the modes, the series impedance matrix $[Z'_{\text{mode}}] = [R'_{\text{mode}}] + j\omega [L'_{\text{mode}}]$ and capacitance matrix $[C'_{\text{mode}}]$ must first be found in modal quantities. This is done by transforming (9) and (10) into the modal domain:

$$-\left[\frac{dV_{\text{mode}}}{dx}\right] = \underbrace{[S]^{-1} [Z'_{\text{phase}}] [T]_{\text{normalized}}}_{[Z'_{\text{mode}}]} \cdot [I_{\text{mode}}]$$

$$\text{and } -\left[\frac{dI_{\text{mode}}}{dx}\right] = \underbrace{[T]_{\text{normalized}}^{-1} [j\omega C'_{\text{phase}}] [S]}_{[j\omega C'_{\text{mode}}]} \cdot [V_{\text{mode}}]$$

Both matrices are diagonal, which can be seen by inserting $[T]_{\text{normalized}}$ from (19) and (18):

$$[Z'_{\text{mode}}] = \frac{1}{j\omega} [\Lambda] [D]^{-1} = \frac{1}{j\omega} \begin{bmatrix} \frac{\lambda_1}{d_1} & & & \\ & \frac{\lambda_2}{d_2} & & \\ & & \frac{\lambda_3}{d_3} & \dots \\ & & & \dots & \frac{\lambda_M}{d_M} \end{bmatrix}$$

$$\text{and } [j\omega C'_{\text{mode}}] = j\omega [D] = j\omega \begin{bmatrix} d_1 & & & \\ & d_2 & & \\ & & d_3 & \dots \\ & & & \dots & d_M \end{bmatrix}$$

Therefore we get $(Z_{\text{surge}})_{\text{mode } i} = \sqrt{\frac{\lambda_i}{-\omega^2 d_i^2}} = \frac{1}{\omega d_i} \sqrt{-\lambda_i} \quad (21)$

For unnormalized $[T]$, set all $d_i = 1$ in eq. (21).

Modal analysis has been used to study power line carrier problems [10, 1, 17] as well as radio noise interference [18,19] . It is interesting to note that the modal distribution in single circuits with horizontal configuration is practically identical with α, β, O - components [20] . Fig. 2 taken from [19] gives an interesting picture of the distribution of mode currents in double circuit lines at 1MHz (each mode is independent of the others). Note that the modal transformation has only been defined for one specific frequency, in general a different transformation must be used if the frequency is changed.

This leads to difficulties in studying transient phenomena containing many frequencies. In time domain solutions one is almost forced to assume that the transformation matrix does not change over a certain frequency range. In frequency domain solutions it is always possible, though costly, to find a new transformation matrix at each frequency.

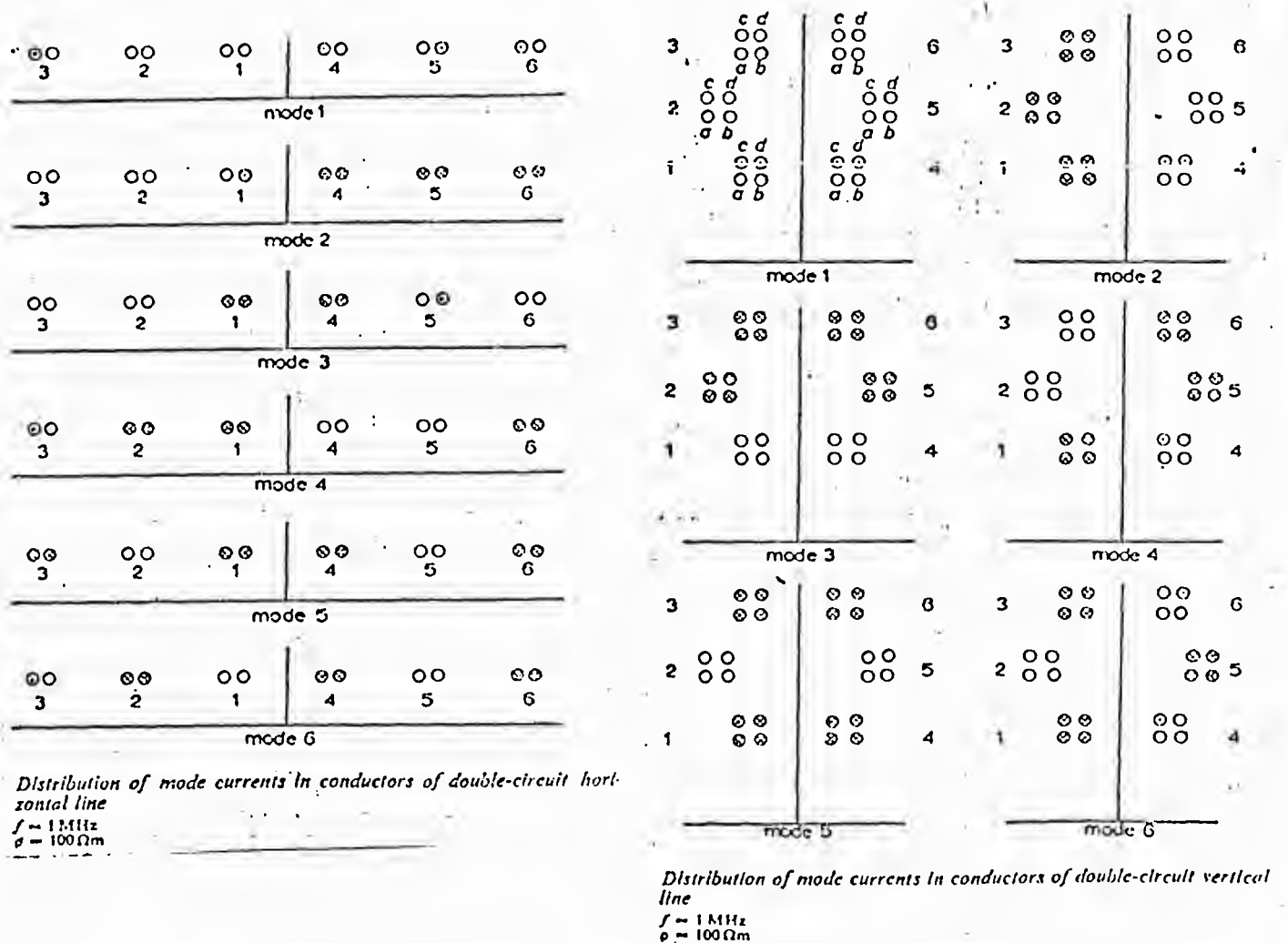

FIG. 2. Distribution of mode currents ³⁰

5. SYMMETRICAL AND OTHER COMPONENTS FOR TRANSPOSED AND BALANCED LINES

Power lines are transposed to equalize the series impedance and shunt capacitance among the phases to avoid unbalances in voltages and/or currents. Transposed lines can be studied much easier with symmetrical components, because the 3 coupled equations in the phase domain,

$$-\begin{bmatrix} \frac{dV_A}{dx} \\ \frac{dV_B}{dx} \\ \frac{dV_C}{dx} \end{bmatrix} = \begin{bmatrix} Z'_{AA} & Z'_{AB} & Z'_{AC} \\ Z'_{BA} & Z'_{BB} & Z'_{BC} \\ Z'_{CA} & Z'_{CB} & Z'_{CC} \end{bmatrix} \begin{bmatrix} I_A \\ I_B \\ I_C \end{bmatrix}$$

become 3 decoupled equations in the domain of symmetrical components,

$$-\frac{dV_{zero}}{dx} = Z'_{zero} \cdot I_{zero}$$

$$-\frac{dV_{pos}}{dx} = Z'_{pos} \cdot I_{pos}$$

$$-\frac{dV_{neg}}{dx} = Z'_{neg} \cdot I_{neg}$$

This decoupling effect is the primary reason for using symmetrical components instead of phase quantities. It should be remembered, however, that this simplification is only true for transposed lines. Therefore, it would be foolish to study untransposed lines with symmetrical components. Instead, coupled equations in the phase domain or modal transformations as described in section 4 should be used for untransposed lines.

Theoretically, the line would have to be continuously transposed to get decoupled equations in the domain of symmetrical components. Of course, such a line cannot be built! But the decoupling effect is still realized with sufficient accuracy for lines with practical transposition, as long as

- (a) the transposition sections have approximately equal length, and
- (b) the length of a complete transposition cycle (3 sections for a single circuit) is much shorter than the wave length of the frequencies involved in the study.

Because of the second assumption symmetrical components are of little use in carrier problems. If assumption (b) is true, then it is permissible to equalize the series impedances by themselves and to equalize the shunt capacitances by themselves. The process will only be shown for the series impedances because it is analogous for the shunt capacitances.

5.1 Symmetrical components for three-phase single circuits

For a single three-phase circuit there is only one way of transposition as shown in Fig. 3. Each conductor occupies all 3 possible locations i, k, m

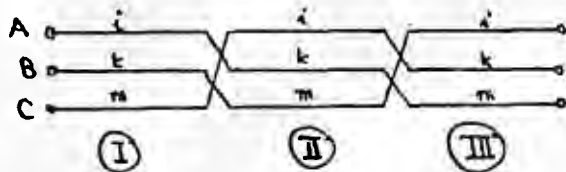

within a complete transposition cycle of 3 sections I, II and III. The voltage drop per unit length is the sum of the voltage drops in the 3 sections.*)

Fig. 3. Transposition for single circuit.

$$\begin{bmatrix} \Delta V_A \\ \Delta V_B \\ \Delta V_C \end{bmatrix} = \begin{bmatrix} \Delta V_{i-I} \\ \Delta V_{k-I} \\ \Delta V_{m-I} \end{bmatrix} + \begin{bmatrix} \Delta V_{k-II} \\ \Delta V_{m-II} \\ \Delta V_{i-II} \end{bmatrix} + \begin{bmatrix} \Delta V_{m-III} \\ \Delta V_{i-III} \\ \Delta V_{k-III} \end{bmatrix}$$

For each section the series impedance is

$$= \frac{1}{3} \begin{bmatrix} Z'_{ii} & Z'_{ik} & Z'_{im} \\ Z'_{ki} & Z'_{kk} & Z'_{km} \\ Z'_{mi} & Z'_{mk} & Z'_{mm} \end{bmatrix}$$

* ΔV_A is used for $-\frac{dV_A}{dx}$

If we define

$$\begin{bmatrix} \Delta V_A \\ \Delta V_B \\ \Delta V_C \end{bmatrix} = \begin{bmatrix} Z'_{\text{phase}} \end{bmatrix} \cdot \begin{bmatrix} I_A \\ I_B \\ I_C \end{bmatrix} \quad (22a)$$

than we see that

$$[Z'_{\text{phase}}] = \frac{1}{3} \left\{ \begin{bmatrix} Z'_{ii} & Z'_{ik} & Z'_{im} \\ Z'_{ki} & Z'_{kk} & Z'_{km} \\ Z'_{mi} & Z'_{mk} & Z'_{mm} \end{bmatrix} + \begin{bmatrix} Z'_{kk} & Z'_{km} & Z'_{ki} \\ Z'_{mk} & Z'_{mm} & Z'_{mi} \\ Z'_{ik} & Z'_{im} & Z'_{ii} \end{bmatrix} + \begin{bmatrix} Z'_{mm} & Z'_{mi} & Z'_{mk} \\ Z'_{im} & Z'_{ii} & Z'_{ik} \\ Z'_{km} & Z'_{ki} & Z'_{kk} \end{bmatrix} \right\} \quad (22b)$$

Remembering that $Z'_{ik} = Z'_{ki}$ etc. in (22) and introducing average values for self and mutual impedances,

$$\begin{aligned} Z'_s &= \frac{1}{3} (Z'_{ii} + Z'_{kk} + Z'_{mm}) \\ Z'_m &= \frac{1}{3} (Z'_{ik} + Z'_{km} + Z'_{mi}) \end{aligned} \quad (23)$$

one gets

$$[Z'_{\text{phase}}] = \begin{bmatrix} Z'_s & Z'_m & Z'_m \\ Z'_m & Z'_s & Z'_m \\ Z'_m & Z'_m & Z'_s \end{bmatrix}$$

where all diagonal elements ("self") and off-diagonal elements ("mutual") are equal among themselves. *This is not too surprising because transposition is used in the first place to equalize the impedances.

Symmetrical components are obtained through the linear transformations (identical for voltages and currents)

$$\begin{bmatrix} I_{\text{zero}} \\ I_{\text{pos.}} \\ I_{\text{neg.}} \end{bmatrix} = \frac{1}{\sqrt{3}} \underbrace{\begin{bmatrix} 1 & 1 & 1 \\ 1 & a & a^2 \\ 1 & a^2 & a \end{bmatrix}}_{[S]^{-1}} \cdot \begin{bmatrix} I_A \\ I_B \\ I_C \end{bmatrix} \quad (24a)$$

and

$$\begin{bmatrix} I_A \\ I_B \\ I_C \end{bmatrix} = \frac{1}{\sqrt{3}} \underbrace{\begin{bmatrix} 1 & 1 & 1 \\ 1 & a^2 & a \\ 1 & a & a^2 \end{bmatrix}}_{[S]} \cdot \begin{bmatrix} I_{\text{zero}} \\ I_{\text{pos.}} \\ I_{\text{neg.}} \end{bmatrix} \quad (24b)$$

* Matrices with these properties will be called "balanced".

with $a = e^{j120^\circ}$. The sequence quantities in (24a) and (24b) are normalized. Often, unnormalized quantities are used; then the factor in (24a) is $1/3$ instead of $1/\sqrt{3}$ and in (24b) it is 1 instead of $1/\sqrt{3}$.* With these transformations, eq. (22a) is transformed into

$$\begin{bmatrix} \Delta V_{\text{zero}} \\ \Delta V_{\text{pos.}} \\ \Delta V_{\text{neg.}} \end{bmatrix} = \underbrace{[S]^{-1} [Z'_{\text{phase}}] [S]}_{[Z'_{\text{symm}}]} \begin{bmatrix} I_{\text{zero}} \\ I_{\text{pos.}} \\ I_{\text{neg.}} \end{bmatrix} \quad (25a)$$

with

$$[Z'_{\text{symm}}] = \begin{bmatrix} Z'_s + 2Z'_m & 0 & 0 \\ 0 & Z'_s - Z'_m & 0 \\ 0 & 0 & Z'_s - Z'_m \end{bmatrix} \quad (25b)$$

The diagonal form of the matrix in eq. (25b) proves that the equations do indeed become decoupled.

Positive and negative sequence quantities are identical. The zero and positive sequence series resistance and inductance are a function of the frequency as shown in Fig. 4. All capacitance matrices are independent of frequency.

Practical computation of sequence quantities: It is not necessary to carry out the averaging process of eq. (22b). Instead, the series impedance matrix for the untransposed line can be transformed directly, yielding

$$[Z'_{\text{symm}}] = [S]^{-1} \begin{bmatrix} Z'_{ii} & Z'_{ik} & Z'_{im} \\ Z'_{ki} & Z'_{kk} & Z'_{km} \\ Z'_{mi} & Z'_{mk} & Z'_{mm} \end{bmatrix} [S] = \begin{bmatrix} \boxed{Z'_s + 2Z'_m} & Z'_{\text{zero, pos.}} & Z'_{\text{zero, neg.}} \\ Z'_{\text{pos., zero}} & \boxed{Z'_s - Z'_m} & Z'_{\text{pos., neg.}} \\ Z'_{\text{neg., zero}} & Z'_{\text{neg., pos.}} & \boxed{Z'_s - Z'_m} \end{bmatrix}$$

(Z' zero) (Z' pos.) (Z' neg.)

This is the matrix which is produced by the line constants program. If the line is transposed, simply ignore the coupling terms.

The diagonal elements are the desired sequence quantities. The off-diagonal elements are not zero anymore. Their values are useful for untransposed lines because they show the coupling between sequence quantities. Often, unbalance factors are derived from them [22], such as

$$M_0 = \left| \frac{Z'_{\text{zero, pos.}}}{Z'_{\text{zero}}} \right| \cdot 100$$

which is the percent coupling from zero sequence to positive sequence

*Normalization has no influence on the sequence impedance, because the factors always cancel out in the product $[S]^{-1} [Z_{\text{phase}}] \times [S]$. However it does influence the scaling of sequence currents and voltages as expressed

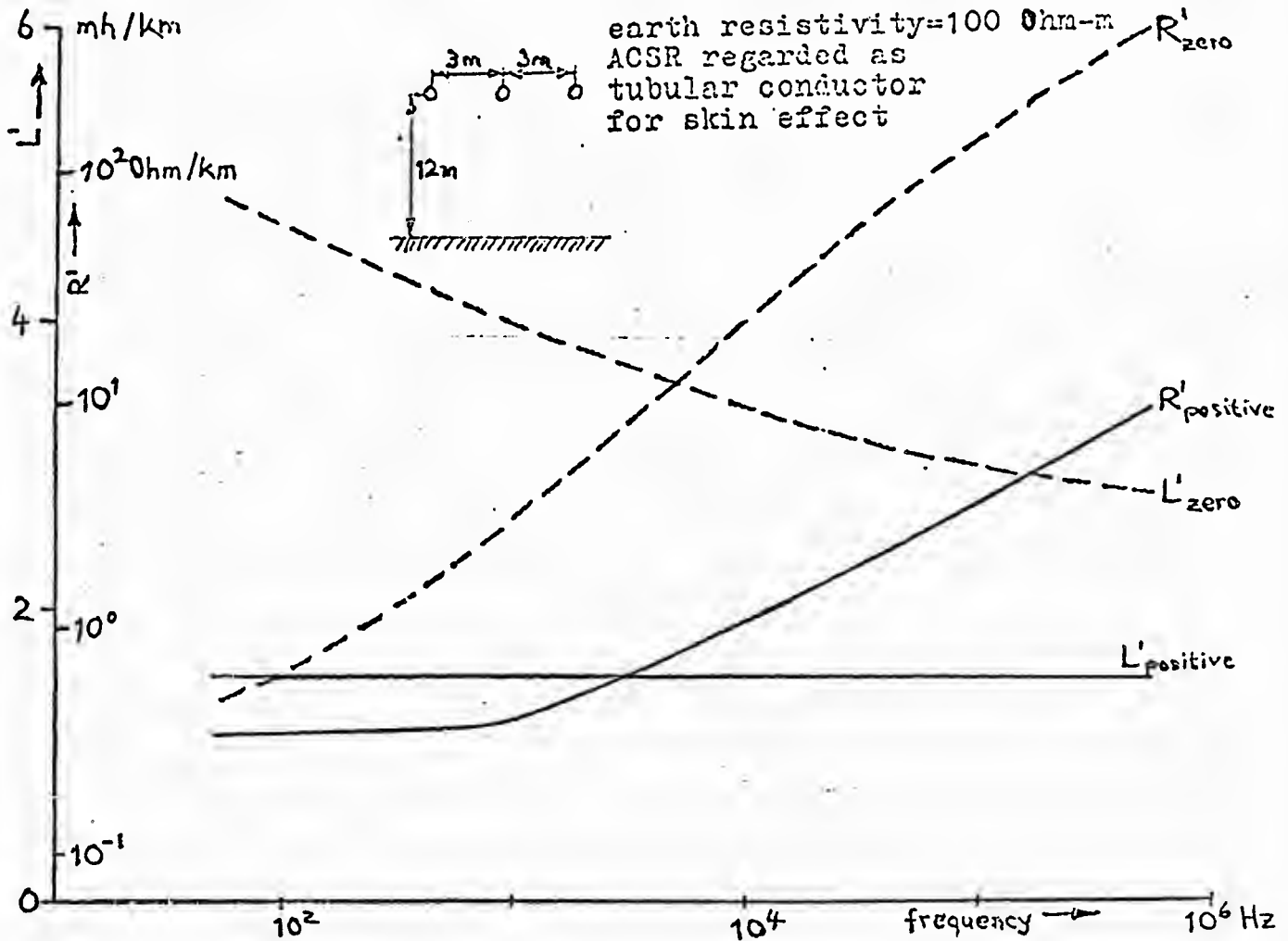

Fig.4. Positive and zero sequence impedance of 3-phase circuit

5.2 Symmetrical components for three-phase double and more circuits

The ideas of transposition can be extended to double circuits (2 three-phase circuits on one tower). However, there will always be coupling between the zero sequences of the two circuits. Appendix 5 gives a summary of the pertinent results for the double circuit line.

In general, the transformation for K three-phase circuits has the form

$$\begin{bmatrix} \dots \\ \dots \\ \dots \\ \dots \\ \dots \\ \dots \\ \dots \\ \dots \\ \dots \\ \dots \end{bmatrix} [Z'_{sym}] = \underbrace{\begin{bmatrix} [S]^{-1} & & & \\ & [S]^{-1} & & \\ & & \ddots & \\ & & & [S]^{-1} \end{bmatrix}}_{\text{block-diagonal}} \underbrace{\begin{bmatrix} \dots \\ \dots \\ \dots \\ \dots \\ \dots \\ \dots \\ \dots \\ \dots \\ \dots \\ \dots \end{bmatrix}}_{(3K) \times (3K) \text{ matrix}} \underbrace{\begin{bmatrix} [S] & & & \\ & [S] & & \\ & & \ddots & \\ & & & [S] \end{bmatrix}}_{\text{block-diagonal (26)}}$$

Trick for retaining symmetry in symmetrical component matrices

Computer programs usually take advantage of symmetry in the original matrices for all physical conductors and in the reduced matrices for the equivalent phase conductors by computing and storing elements in and below the diagonal only. This cannot be done directly for $[Z_{symm}^{\text{untransposed}}]$ in (26) because the transformation destroys the symmetry. However, Shipley proposed a scheme of exchanging certain columns in $[Z_{symm}^{\text{untransposed}}]$ which preserves the symmetry [1,2]. For K three-phase circuits, the result will be in the order

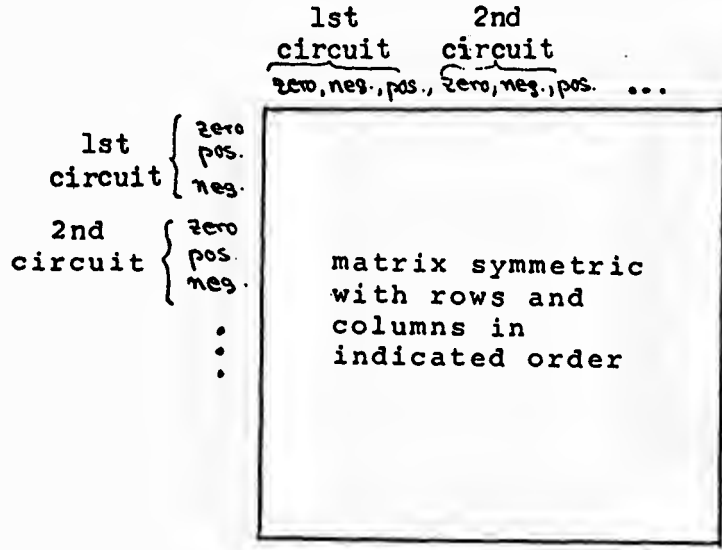

Obviously, the equality $Z_{zero, neg.}^i = Z_{pos., zero}^i$ etc.

must be true.

5.3 Karrenbauer's transformation

See section 4.1 of SUPPLEMENT to paper "Digital computer solution of electromagnetic transients in single and multiphase networks" by H.W. Dommel, dated April 1970.

5.4 Symmetrical components for two-pole HVDC line

The idea of symmetrical components can be generalized to M phases. Therefore, it can also be used for two-pole HVDC lines. There are some arguments, however, whether it is wise to use the words "symmetrical components" and "zero and positive sequence". Indeed, zero sequence and positive sequence of a two-pole symmetric line are identical with the ground mode and metallic mode of Karrenbauer's transformation.

There is no need to transpose a symmetric two-pole line with conductors at equal height, because the impedances are already equal, with

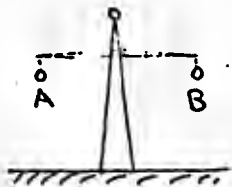

$$[Z'_{\text{phase}}] = \begin{bmatrix} Z'_s & Z'_m \\ Z'_m & Z'_s \end{bmatrix} \quad 160$$

(assuming identical conductors or bundle conductors in A and B at equal height, and symmetrically placed ground wires, if any)

The transformation (identical for voltages and currents) is

$$\begin{bmatrix} I_{\text{zero}} \\ I_{\text{pos.}} \end{bmatrix} = \frac{1}{\sqrt{2}} \begin{bmatrix} 1 & 1 \\ 1 & -1 \end{bmatrix} \begin{bmatrix} I_A \\ I_B \end{bmatrix}$$

$$\text{and} \quad \begin{bmatrix} I_A \\ I_B \end{bmatrix} = \frac{1}{\sqrt{2}} \begin{bmatrix} 1 & 1 \\ 1 & -1 \end{bmatrix} \begin{bmatrix} I_{\text{zero}} \\ I_{\text{pos.}} \end{bmatrix}$$

and the associated matrix in symmetrical components

$$[Z'_{\text{symm}}] = \begin{bmatrix} Z'_s + Z'_m & 0 \\ 0 & Z'_s - Z'_m \end{bmatrix}$$

For unnormalized sequence quantities, the factor in the first equation would be $\frac{1}{2}$ instead of $\frac{1}{\sqrt{2}}$ and in the second equation 1 instead of $\frac{1}{\sqrt{2}}$.

6. EQUIVALENT MULTI- π -CIRCUIT FOR UNTRANSPOSED LINES

A multiphase line can be represented by an equivalent multi- π -circuit, which correctly describes the steady-state conditions at its terminals for a specific frequency and length. This is the generalization of the well-known equivalent π for the single-phase line. Note that such equivalents represent the line only for steady-state conditions (frequency and length fixed); they cannot be used for transient phenomena and give no information between the terminals along the line.

The equivalent multi- π is characterized by a transfer admittance matrix $[Y_{\text{transfer}}]$ from terminal 1 to 2 and a shunt admittance matrix $[Y_{\text{shunt}}]$ at both terminals (see Fig. 5p.21). Their meaning is expressed in the formula:

$$\begin{bmatrix} [Y_{\text{transfer}}] + [Y_{\text{shunt}}] & -[Y_{\text{transfer}}] \\ -[Y_{\text{transfer}}] & [Y_{\text{transfer}}] + [Y_{\text{shunt}}] \end{bmatrix} \begin{bmatrix} [V_1] \\ [V_2] \end{bmatrix} = \begin{bmatrix} [I_1] \\ [I_2] \end{bmatrix} \quad (27)$$

where $[V_1]$, $[V_2]$, $[I_1]$, $[I_2]$ are the voltage and current vectors at both terminals. If the line has M phases, then $[Y_{\text{transfer}}]$, $[Y_{\text{shunt}}]$ are $M \times M$ matrices and (27) is a system of $2M$ equations.

Transposed and single-phase lines

It is well known how to compute $Y_{transfer}$ and Y_{shunt} for the single-phase line,

$$Y_{transfer} = \frac{1}{B} \text{ and } Y_{shunt} = (A-1) \cdot Y_{transfer} \quad (28)$$

with $A = \cosh (s \sqrt{z'y'})$

$$B = \sqrt{\frac{z'}{y'}} \cdot \sinh (s \sqrt{z'y'})$$

s = length of line
 z' = series impedance per-unit length
 y' = shunt admittance per-unit length

use these equations for transposed lines in each sequence

Fig. 6 shows $Z_{transfer} = 1/Y_{transfer}$ and Y_{shunt} for a single-phase line as a function of length. If the line-length is short, compared to the wave length, then

$$Z_{transfer} = 1/Y_{transfer} \approx s \cdot z' \quad \text{for } s \ll \lambda \quad (29)$$

$$Y_{shunt} \approx s \cdot y'$$

This is sometimes called the nominal π in contrast to the exact equivalent π .

For transposed lines each sequence is computed independently with eq. (28). The solution is more difficult for untransposed lines, in that case, the scalar equations (28) can be generalized for the multiphase line by using eigenvalues [4]. A different approach is used in BPA's program, which was indicated in a discussion to ref. 4 by W. F. Tinney. First choose an incremental length Δs which is short enough to justify the use of equation (29).

The respective equivalent multi- π for length Δs then has

$$\begin{aligned} [Y_{transfer}] &= \frac{1}{\Delta s} \cdot [Z']^{-1} \\ [Y_{shunt}] &= \frac{\Delta s}{2} \cdot [Y'] \end{aligned} \quad \text{with } \begin{cases} [Z'] = \text{series impedance matrix p.u. length} \\ [Y'] = \text{shunt admittance matrix p.u. length} \end{cases} \quad (29b)$$

If two such equivalents are now connected in series (Fig. 7), one gets a new equivalent for the doubled length $2 \cdot \Delta s$ after eliminating the passive "inner" nodes (3) in the system of $3M$ nodal equations. An efficient elimination scheme is explained in appendix 6. This doubling of the length by series connection of the latest equivalents will finally lead to an equivalent for the desired length s , via equivalents for $\Delta s, 2 \Delta s, 4 \Delta s, 8 \Delta s, \dots$ (Δs is chosen such that $2^k \cdot \Delta s = s$ with $k =$ positive integer, in order to arrive exactly at the length s). Two bounds must be taken into account in the choice of Δs ; on one hand it should be small enough to justify the use of eq. (29), on the other hand it should not be so small as to cause serious round-off errors and an excessive number of doubling procedures. Appendix 7 shows how Δs is chosen by the computer. With this choice, the values for the single-phase line of Fig. 6 compare at 800 miles with the exact values as follows (Δs was 12.5 miles):

	$Y_{transfer}$ in mmho	Y_{shunt} in mmho
through successive doubling	0.16800-j2.5881	0.13546+j2.8073
exact	0.16800-j2.5883	0.13548+j2.8074

For a three-phase line of 200 miles, used in ref. 4, the results had a maximum relative error in magnitude of $3 \cdot 10^{-4}$ and a maximum phase error of 0.03° in the transfer impedance and shunt admittance elements.

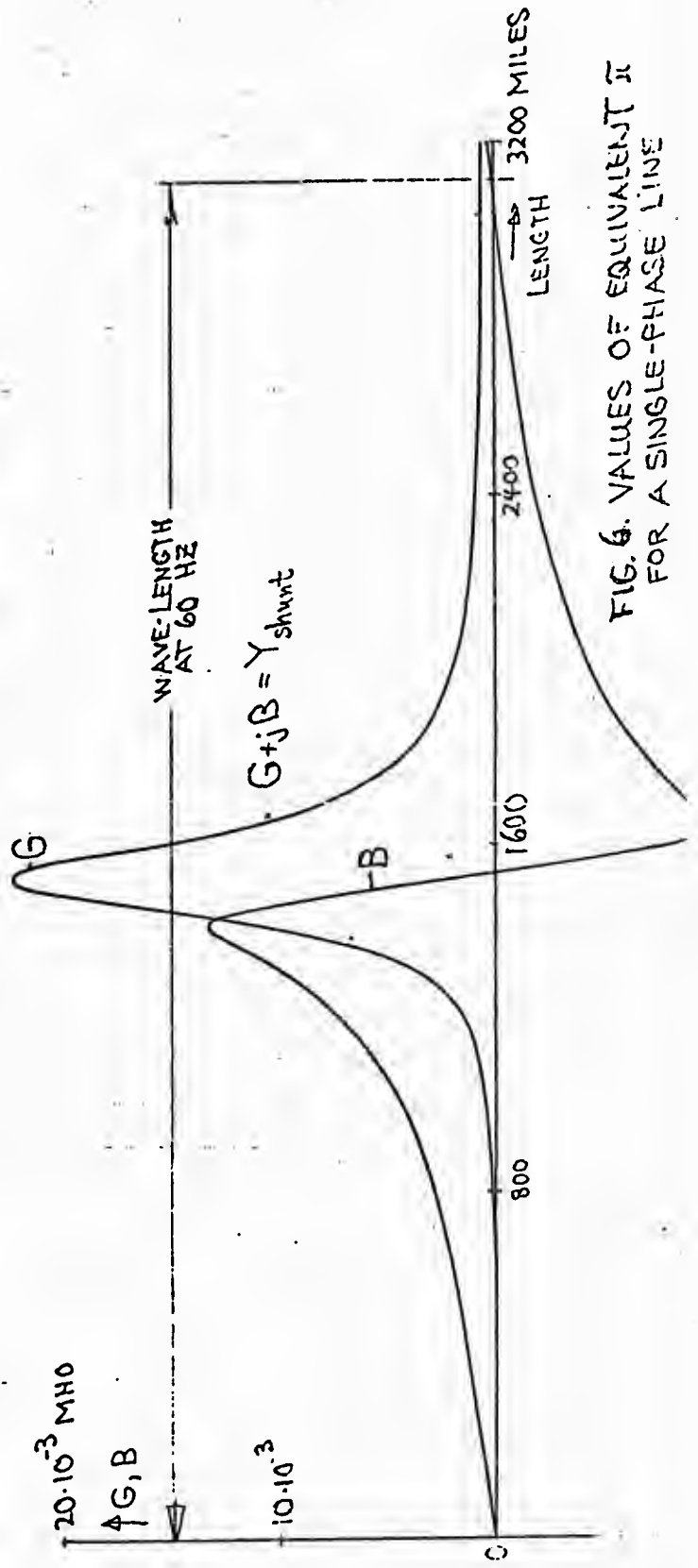
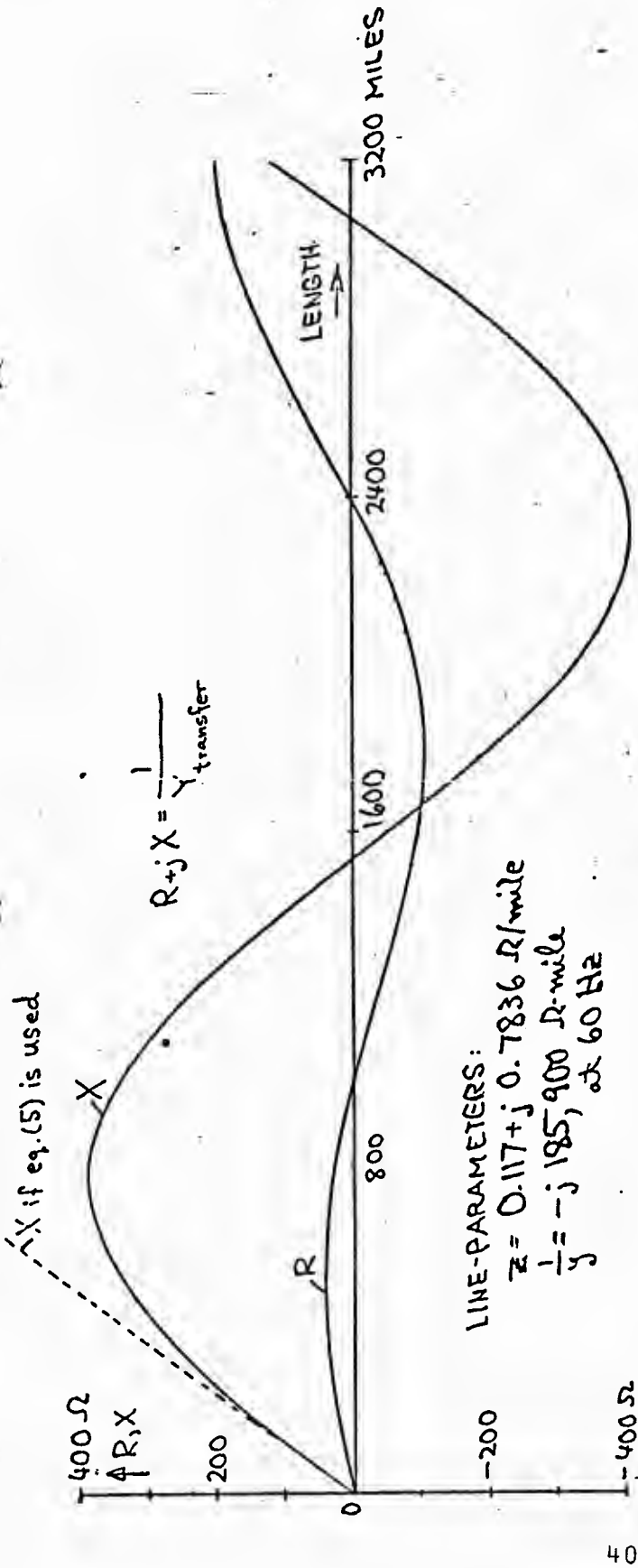

FIG. 6. VALUES OF EQUIVALENT π FOR A SINGLE-PHASE LINE

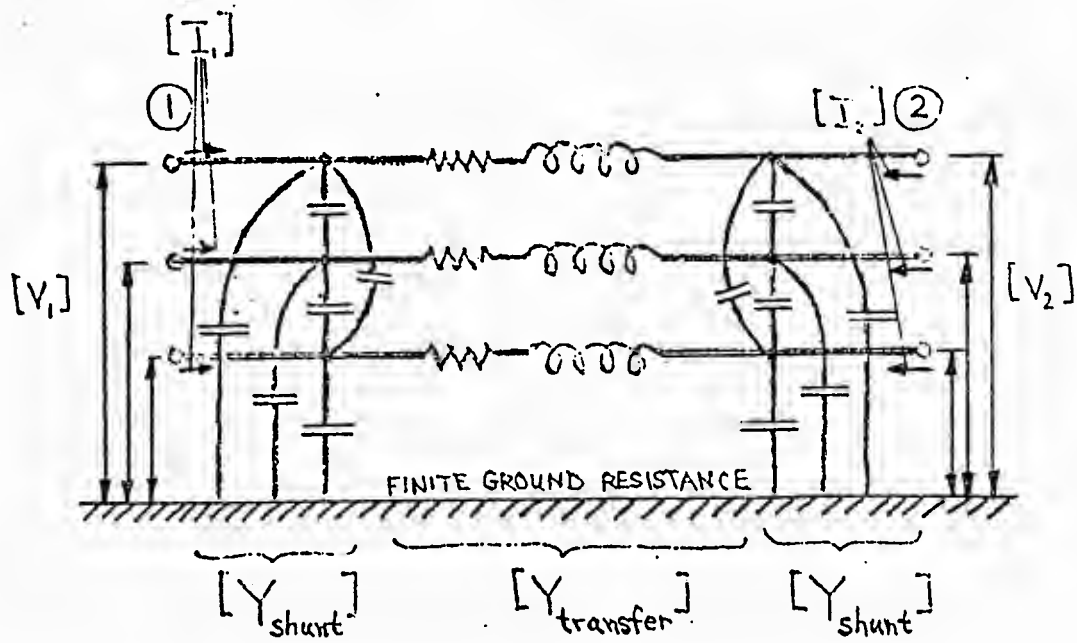

FIG. 5. EQUIVALENT MULTI- π CIRCUIT

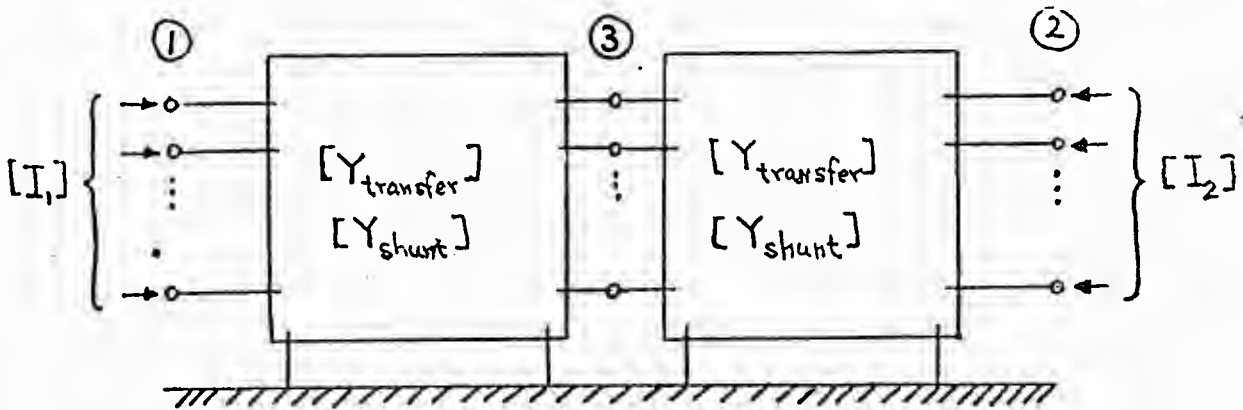
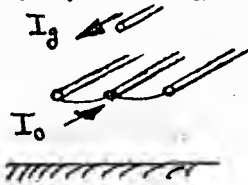

FIG. 7. SERIES CONNECTION OF 2 IDENTICAL EQUIVALENTS

7. SCREENING MATRIX

In interference studies the current in the ground wires must also be known. As indicated in the sketch, a zero sequence current in the



phases returns partly through the ground wire. This ground wire current cancels part of the voltage induced in neighboring communication lines by the zero sequence current, thus acting as a "screen" for magnetic induction. Since the line constants normally used have the ground wires eliminated,

it is necessary to recover the ground current. For the case indicated in the sketch with all 3 phases bundled to simulate zero sequence operation, one would have a system of 2 equations

$$\begin{bmatrix} -\frac{dV_0}{dx} \\ 0 \end{bmatrix} = \begin{bmatrix} Z_{00}' & Z_{0g}' \\ Z_{g0}' & Z_{gg}' \end{bmatrix} \begin{bmatrix} I_0 \\ I_g \end{bmatrix}$$

The second equation permits the recovery of the ground current I_g :

$$I_g = -\frac{Z_{g0}'}{Z_{gg}'} I_0, \quad \text{where } -\frac{Z_{g0}'}{Z_{gg}'} \text{ is called the screening}$$

factor. The impedances are:

Z_{gg}' = self impedance of ground wire

Z_{g0}' = mutual impedance between zero sequence bundle of phase conductors and ground wire.

The idea can easily be generalized for the multiphase line. Let

F = subset of all phases (after bundling has been carried out)

G = subset of all ground wires.

Then

$$\begin{bmatrix} -\left[\frac{dV_F}{dx}\right] \\ 0 \end{bmatrix} = \begin{bmatrix} [Z_{FF}'] & [Z_{FG}'] \\ [Z_{GF}'] & [Z_{GG}'] \end{bmatrix} \begin{bmatrix} [I_F] \\ [I_G] \end{bmatrix}$$

From this, the recovery of currents in the ground wires is seen to be

$$[I_G] = -\underbrace{[Z_{GG}']^{-1} [Z_{GF}']}_{\text{Screening matrix}} [I_F]$$

Screening matrix

The screening matrix is the transposed of the distribution factor matrix

explained in appendix 4. As indicated in the flow chart for REDUCT in appendix 4, the transposed distribution factor matrix and, therefore, the screening matrix, are directly obtained as a by-product of the reduction process.

Fig. 8 shows the phase currents in the 2 poles of an HVDC line for the sixth harmonic (360 Hz) as a function of line distance. The currents in the two ground wires (LT.GRD. = left ground wire, RT.GRD. = right ground wire) which are also plotted were recovered with the screening matrix mentioned above [7].

8. SEGMENTED GROUND WIRES

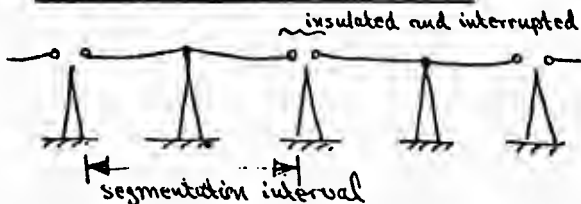

Segmented ground wires are interrupted and insulated at certain intervals to prevent the flow of circulating currents. In effect, they act as an electrostatic shield.

Segmented ground wires will not carry any noticeable current as long as the wave length of the particular frequency is much larger than the length of the segmentation interval. This is true at power frequency but is not true at higher frequencies associated with lightning surges. For switching surges it may or may not be true.

The nature of the segmentation is taken into account by ignoring the ground wires in the computation of the series impedance matrix but considering them in the computation of the shunt capacitance matrix.

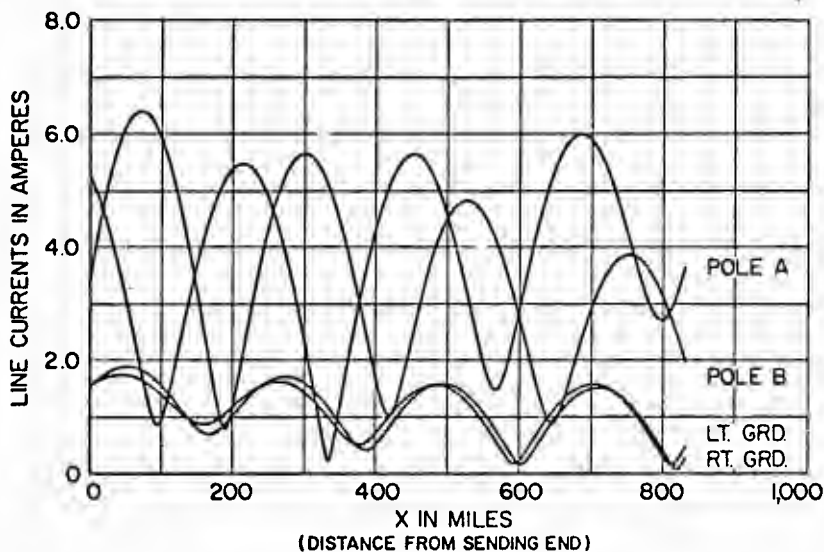

Fig. 8. Currents of sixth harmonic in HVDC line

Classical textbooks always equate the positive sequence resistance with the conductor resistance (for bundle conductors

$R = \frac{\text{resistance for individual conductor}}{\text{number of conductors in bundle}}$, possibly corrected for conductor skin effect. The values obtained with the exact formulas may differ slightly for two reasons:

- (a) The ground return influences the positive sequence impedance slightly which is not borne out by classical formulas. The influence is usually very small at 60 Hz but may become noticeable at higher frequencies.
- (b) The presence of ground wires may have a noticeable effect on the positive sequence impedance. A particular case at 60 Hz gave

$$R_{\text{conductor}} = 0.0657 \text{ } \Omega \text{ /mile}$$

$$R_{\text{positive}} = 0.0703 \text{ } \Omega \text{ /mile, which is } 6\text{-}1/2\% \text{ higher}$$

This difference is primarily caused by the presence of a ground wire. Even under symmetric (positive sequence) operation the voltages induced in the ground wire by the symmetric currents in the 3 phases will not cancel entirely because the distances from the phase conductors to the ground wire and, therefore, the mutual impedances, are usually not all equal. The remaining induced voltage will cause a circulating current (return through ground); the associated losses are proportional to the positive sequence current and are accounted for by an increase in the positive sequence resistance. This effect will not show up with segmentation of ground wires. As a matter of fact, this is the reason for using segmentation.

APPENDICES

Appendix 1. Line parameters

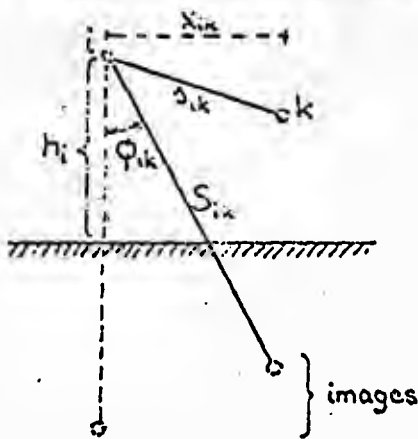

a) Series impedance. Carson's formula [12] is used for calculating the impedance matrix $[Z']$. It is based on the assumptions that the conductors are long enough, so that end effects may be neglected, and that the earth has uniform conductivity and is bounded by a flat plane with infinite extent, to which the conductors are parallel. As average height above ground the value "height at midspan + 1/3 of sag" is usually taken. The spacing between conductors is assumed large enough to neglect the proximity effect. The elements of $[Z']$ are for the self impedance

$$Z'_{ii} = (R'_{ii} + \Delta R'_{ii}) + j (2\omega \cdot 10^{-4} \ln \frac{2h_i}{GMR_i} + \Delta X'_{ii}) \quad \text{in } \Omega\text{m/km} \quad (30)$$

and for the mutual impedance

$$Z'_{ik} = Z'_{ki} = \Delta R'_{ik} + j (2\omega \cdot 10^{-4} \ln \frac{S_{ik}}{s_{ik}} + \Delta X'_{ik}) \quad \text{in } \Omega\text{m/km} \quad (31)$$

with R'_{ii} = resistance of conductor i (for skin effect see app.2)
in ohm/km

h_i = height above ground of conductor i

S_{ik} = distance between conductor i and image of conductor k

s_{ik} = distance between conductors i and k

GMR_i = geometric mean radius of conductor i (for skin effect see app.2)

$\omega = 2\pi f$ with f = frequency in cps.

} in the same units, e.g., in m

The corrections $\Delta R'$ and $\Delta X'$ account for the earth return effect and are functions of the angle ϕ ($\phi = 0$ for self impedance, $\phi = \phi_{ik}$ for mutual impedance) and the parameter a :

$$a = k \cdot S \cdot \sqrt{\frac{f}{\rho}}, \quad k = 4\pi \sqrt{5} \cdot 10^{-4} \quad (32)$$

with $S = \begin{cases} 2h_i & \text{for self impedance in m} \\ S_{ik} & \text{for mutual impedance in m} \end{cases}$
 ρ = earth resistivity in ohm-m.

$\Delta R'$ and $\Delta X'$ become zero for $a \rightarrow \infty$ (very high frequency or very low earth resistivity). Carson gives an infinite integral for $\Delta R'$ and $\Delta X'$, which he developed into the following infinite series for $a \leq 5$ (rearranged for computer purposes):

$$\Delta R^i = 4\omega \cdot 10^{-4} \left\{ \frac{\pi}{8} \right. \\ \left. \begin{aligned} &-b_1 a \cos\phi \\ &+b_2 [(c_2 - \ln a)a^2 \cos 2\phi + \phi a^2 \sin 2\phi] \\ &+b_3 a^3 \cos 3\phi \\ &-d_4 a^4 \cos 4\phi \\ &-b_5 a^5 \cos 5\phi \\ &+b_6 [(c_6 - \ln a)a^6 \cos 6\phi + \phi a^6 \sin 6\phi] \\ &+b_7 a^7 \cos 7\phi \\ &-d_8 a^8 \cos 8\phi \\ &- \dots \end{aligned} \right\}$$

$$\Delta X^i = 4\omega \cdot 10^{-4} \left\{ \frac{1}{2} (0.6159315 - \ln a) \right. \\ \left. \begin{aligned} &+b_1 a \cos\phi \\ &-d_2 a^2 \cos 2\phi \\ &+b_3 a^3 \cos 3\phi \\ &-b_4 [(c_4 - \ln a)a^4 \cos 4\phi + \phi a^4 \sin 4\phi] \\ &+b_5 a^5 \cos 5\phi \\ &-d_6 a^6 \cos 6\phi \\ &+b_7 a^7 \cos 7\phi \\ &-b_8 [(c_8 - \ln a)a^8 \cos 8\phi + \phi a^8 \sin 8\phi] \\ &+ \dots \end{aligned} \right\} \quad (33)$$

Each 4 successive terms form a repetitive pattern. The coefficients b_i , c_i and d_i are constants, which can be precalculated and stored in lists. They are obtained from the recursive formulas:

$$b_i = b_{i-2} \frac{\text{sign}}{i(i+2)} \quad \text{with the starting value} \quad \begin{cases} b_1 = \frac{\sqrt{2}}{6} & \text{for odd} \\ & \text{subscripts} \\ b_2 = \frac{1}{16} & \text{for even} \\ & \text{subscripts} \end{cases} \quad (34)$$

$$c_i = c_{i-2} + \frac{1}{i} + \frac{1}{i+2} \quad \text{with the starting value } c_2 = 1.3659315$$

$$d_i = \frac{\pi}{4} \cdot b_i$$

with sign = ± 1 changing after each 4 successive terms (sign = +1 for $i=1, 2, 3, 4$; sign = -1 for $i=5, 6, 7, 8$ etc.).

For $a > 5$ the following finite series is best used ^{[12]*}:

$$\Delta R^i = \left(\frac{\cos\phi}{a} - \frac{\sqrt{2} \cos 2\phi}{a^2} + \frac{\cos 3\phi}{a^3} + \frac{3 \cos 5\phi}{a^5} - \frac{45 \cos 7\phi}{a^7} \right) \cdot \frac{4\omega \cdot 10^{-4}}{\sqrt{2}} \quad (35)$$

$$\Delta X^i = \left(\frac{\cos\phi}{a} - \frac{\cos 3\phi}{a^3} + \frac{3 \cos 5\phi}{a^5} + \frac{45 \cos 7\phi}{a^7} \right) \cdot \frac{4\omega \cdot 10^{-4}}{\sqrt{2}}$$

The trigonometric functions are calculated directly from the geometry, for conductors i and k :

$$\cos\phi_{ik} = \frac{h_i + h_k}{s_{ik}} \quad \text{and} \quad \sin\phi_{ik} = \frac{x_{ik}}{s_{ik}}$$

and for higher terms in the series from the recursive formulas

$$\begin{aligned} a^i \cos i\phi &= [a^{i-1} \cos(i-1)\phi \cdot \cos\phi - a^{i-1} \sin(i-1)\phi \cdot \sin\phi] \cdot a \\ a^i \sin i\phi &= [a^{i-1} \cos(i-1)\phi \cdot \sin\phi + a^{i-1} \sin(i-1)\phi \cdot \cos\phi] \cdot a \end{aligned} \quad (36)$$

For power circuits at power frequency only few terms in the series of (33) are necessary. The formulas in most textbooks are based on the first few terms. However at higher frequencies and wider spacings - e.g., in interference calculations - the parameter a becomes larger and more and more terms must be taken into

*This is obtained from an asymptotic expansion of Carsen's formula (derivable by repeated partial integrations) and is already shown in Carsen's original paper [12]. Butterworth carries it further to include one more term.

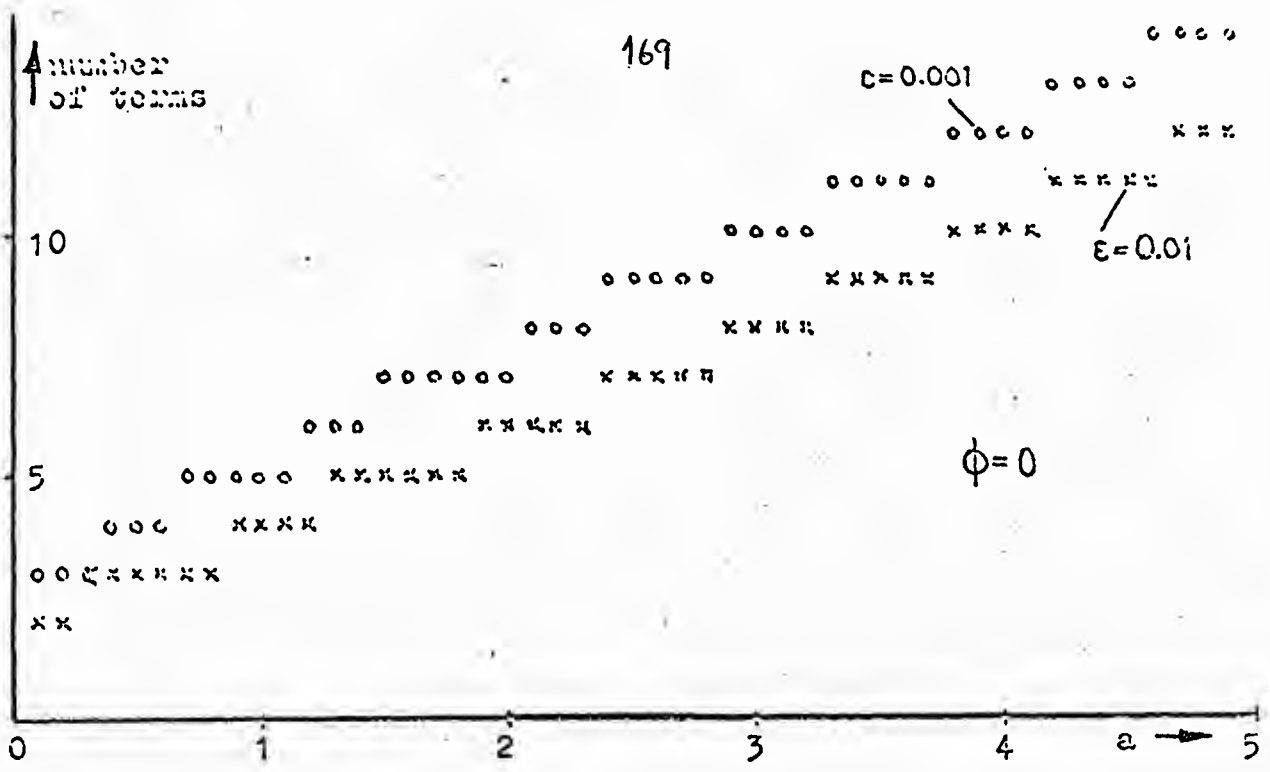

Fig. 9. Number of terms in series of (33) to get an accuracy of $\epsilon = 0.01$ and 0.001

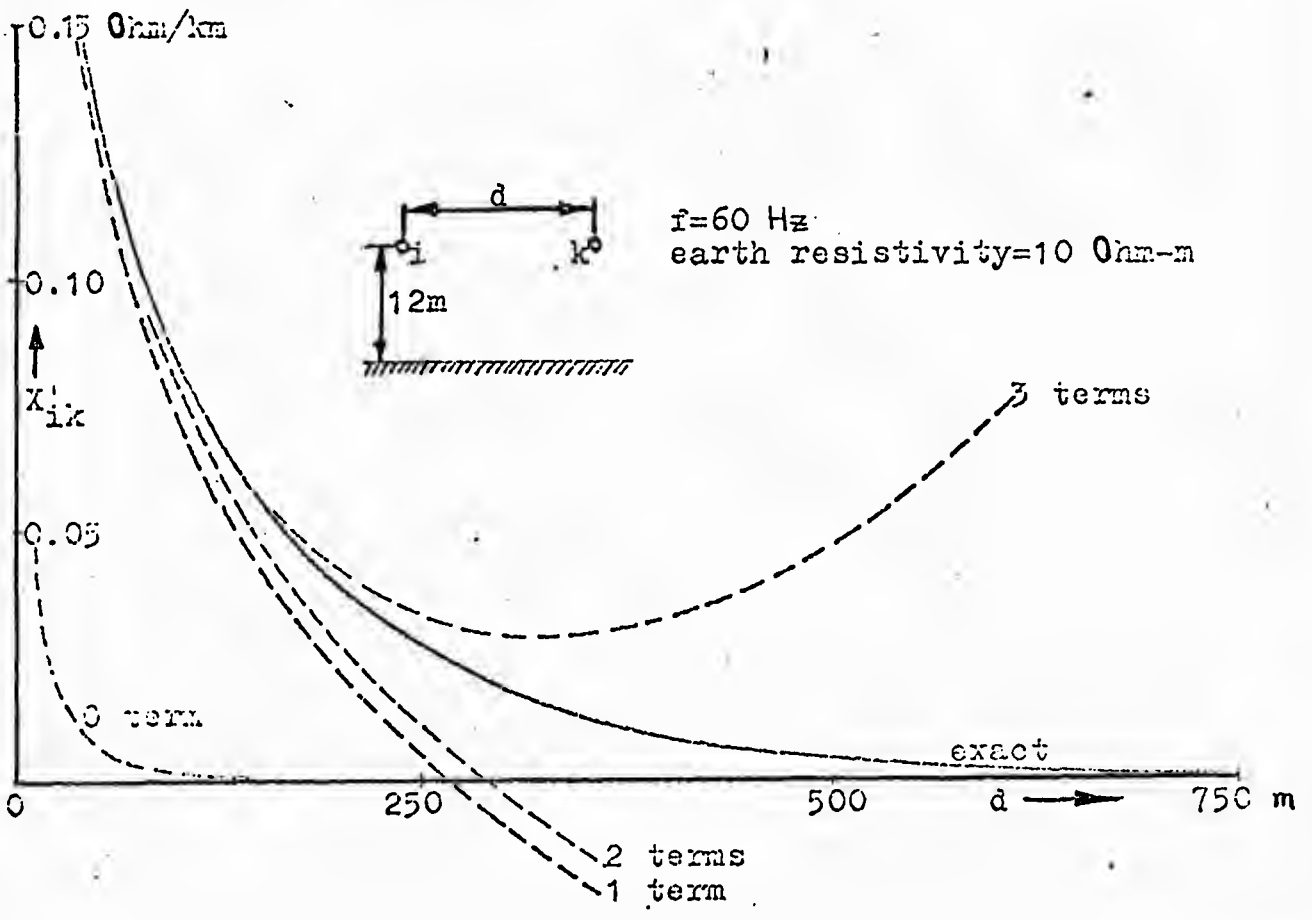

Fig.10 . Mutual reactance per unit length

account. Fig. 9 shows the number of necessary terms in (33) to get the series in the brackets accurate to 2 or 3 digits behind the decimal point, with the values being of the order 0.1 and higher. Fig. 10 shows the mutual reactance as a function of spacing calculated with different numbers of terms in the series. It clearly shows that it is important to take more than the first few terms into account, even at power frequency if the spacing is wide, as in interference calculations. Once the Carson series starts to converge it does so fairly rapidly. How misleading the results with a few terms can be is shown in the following table for $a = 4$ and $\phi = 0$

Number of terms	error $\epsilon = \frac{(\Delta R_{ii}')_{\text{approximate}}}{(\Delta R_{ii}')_{\text{accurate}}} \cdot 100$
1	311.7 %
2	-748.3 %
3	-16.2 %
4	+798.2 %
5	-415.6 %
6	+364.9 %
7	-121.3 %
8	-92.7 %
9	+27.7 %
10	-15.0 %
11	+5.2 %
12	+1.7 %
13	-0.35 %
14	+0.14 %
15	-0.04 %

It might be more economic to substitute the infinite series of (33) with a polynomial approximation with defined error bounds; this was not explored.

b) Shunt capacitance. The capacitance matrix $[C]$ is the inverse of the matrix $[P]$ of the potential coefficients,

$$[C] = [P]^{-1}$$

The elements of $[P]$ are calculated from the geometry. The diagonal element is

$$P_{ii}' = 18 \cdot 10^6 \ln \frac{2h_i}{r_i} \quad \text{in daraf-km} \quad (37)$$

and the off-diagonal element is

$$P_{ik}' = P_{ki}' = 18 \cdot 10^6 \ln \frac{s_{ik}}{s_{ik}} \quad \text{in daraf-km} \quad (38)$$

with r_i = radius of conductor i . The formulas are valid as long as the radii are small compared with the spacings. The exact value for the factor in (37) and (38) is $2c^2 \cdot 10^{-4} \approx 18 \cdot 10^6$ with c = velocity of light in km/s.

Appendix 2. Skin effect in conductors

With increasing frequency the current is more and more crowded toward the surface of the conductor. The consequences are an increase in the resistance and a decrease in the internal inductance.

The total inductance of a nonmagnetic conductor per unit length, as used in eq.(30),

$$L'_{total} = 2 \cdot 10^{-4} \ln \frac{2h}{GMR} \quad \text{in henry/km,}$$

is the result of adding the internal inductance (due to flux inside the conductor) and the external inductance (due to flux outside the conductor),

$$L'_{total} = \underbrace{2 \cdot 10^{-4} \ln \frac{r}{GMR}}_{L'_{internal}} + \underbrace{2 \cdot 10^{-4} \ln \frac{2h}{r}}_{L'_{external}} \quad \text{in henry/km.}$$

Only the internal inductance is influenced by skin effect. Since the internal inductance is only a small fraction of the total inductance, the skin effect on the total inductance is usually small, except for large conductors at high frequencies. However, skin effect on internal inductance is always taken into account (in addition to skin effect on the resistance) when asked for on the conductor card in BPA's line constants program.

When skin effect is taken into account, then the internal inductance becomes negligible at higher frequencies. Neglecting both internal inductance and earth resistivity at high frequencies, the inductance matrix $[L'] = \frac{1}{\omega} \text{Im} \{ Z' \}$ becomes

$$[L'] = \frac{1}{\omega} [P']$$

With these 2 assumptions all waves on multiphase lines will travel at the velocity of light.

The increase in the resistance because of skin effect can be considerable. For solid, round wires the skin effect formula is well known. Stranded conductors can practically be treated as solid conductors of the same cross-sectional area^[4]. Steel-reinforced aluminum cables may approximately be treated as tubular conductors, when the influence of the steel core is negligible. If the magnetic material is of influence, then calculations are less reliable and measurements should be used. Since the solid conductor is a special case of the tubular conductor, the formula for the latter is given^[5] for nonmagnetic material:

$$\frac{R' + j\omega L'_{internal}}{R'_{DC}} = \frac{j \frac{1}{2} m r (1-s^2) (\text{ber } m r + j \text{bei } m r) + \varphi (\text{ker } m r + j \text{kei } m r)}{(\text{ber } m r + j \text{bei } m r) + \varphi (\text{ker } m r + j \text{kei } m r)} \quad (39)$$

$$\text{with } \varphi = - \frac{\text{ber } m q + j \text{bei } m q}{\text{ker } m q + j \text{kei } m q}$$

and R' = resistance with skin effect included in ohm/km

R'_{DC} = DC-resistance in ohm/km

$L'_{internal}$ = inductance with skin effect included in henry/km

r = outside radius

q = inside radius

$$s = \frac{q}{r}$$

f = freq in Hz



$$\begin{aligned}
 (mr)^2 &= k \frac{1}{1-s^2} \\
 (mq)^2 &= k \frac{s^2}{1-s^2}
 \end{aligned}
 \quad \text{with } k = \frac{8\pi \cdot 10^{-4} f}{R_{DC}}$$

The modified Bessel-functions $\text{ber}(\dots) + j\text{bei}(\dots)$, $\text{ber}'(\dots) + j\text{bei}'(\dots)$, $\text{ker}(\dots) + j\text{kei}(\dots)$ and $\text{ker}'(\dots) + j\text{kei}'(\dots)$ can be calculated with polynomial approximations [16.]

Note on magnetic conductors:

In eg. [39] it is assumed that the material is nonmagnetic. However, the formula is also valid for magnetic material if k is redefined:

$$k = \frac{8\pi \cdot 10^{-4} f}{R_{DC}} \mu_r$$

where μ_r = relative permability. Since μ_r is a function of frequency as well as a function of the current (due to saturation), no attempt was made to incorporate $\mu_r \neq 1$ into BPA's line constants program. Modifications can be made, however, for users who want to supply μ_r .

SUBROUTINE FOR SKIN EFFECT

1. Purpose: The Subroutine:

SKIN(S,R,FREQ,RF,XF)

finds the ac resistance and the internal ac reactance (explanation of "internal" in appendix 2) for tubular conductors at any frequency. The solid round conductor is a special case which is automatically included.

The first 3 arguments are input:



$$S = \frac{a}{b} = \frac{\text{inner radius}}{\text{outer radius}}$$

$$R = \text{dc resistance in } \Omega/\text{mile}$$

$$\text{FREQ} = \text{frequency in Hz}$$

The last 2 arguments are the results:

$$\text{RF} = \text{ac resistance in } \Omega/\text{mile}$$

$$\text{XF} = \text{ac internal reactance in } \Omega/\text{mile at the specified frequency,}$$

If ratios are desired, calculate them after execution with

$$\frac{R_{ac}}{R_{dc}} = \frac{R}{RF} \quad \text{and} \quad \frac{L_{\text{internal-ac}}}{L_{\text{internal-dc}}} = \frac{XF}{0.50559135E-3 * \text{FREQ}}$$

2. Formula used: Exact formula is given in appendix 2, where the numerical procedure is also described. In the polynomial approximation from ref. 16, all Kelvin and Bessel functions are multiplied by $\exp\left(-\frac{1+J}{\sqrt{2}}X\right)$ for arguments $X > 8$ to avoid too large numbers (this factor cancels out since it shows up in the numerator and denominator of the skin effect formula).

3. Computer time: The program is in FORTRAN. One call to the subroutine takes about 0.05 s on an IBM 7040.

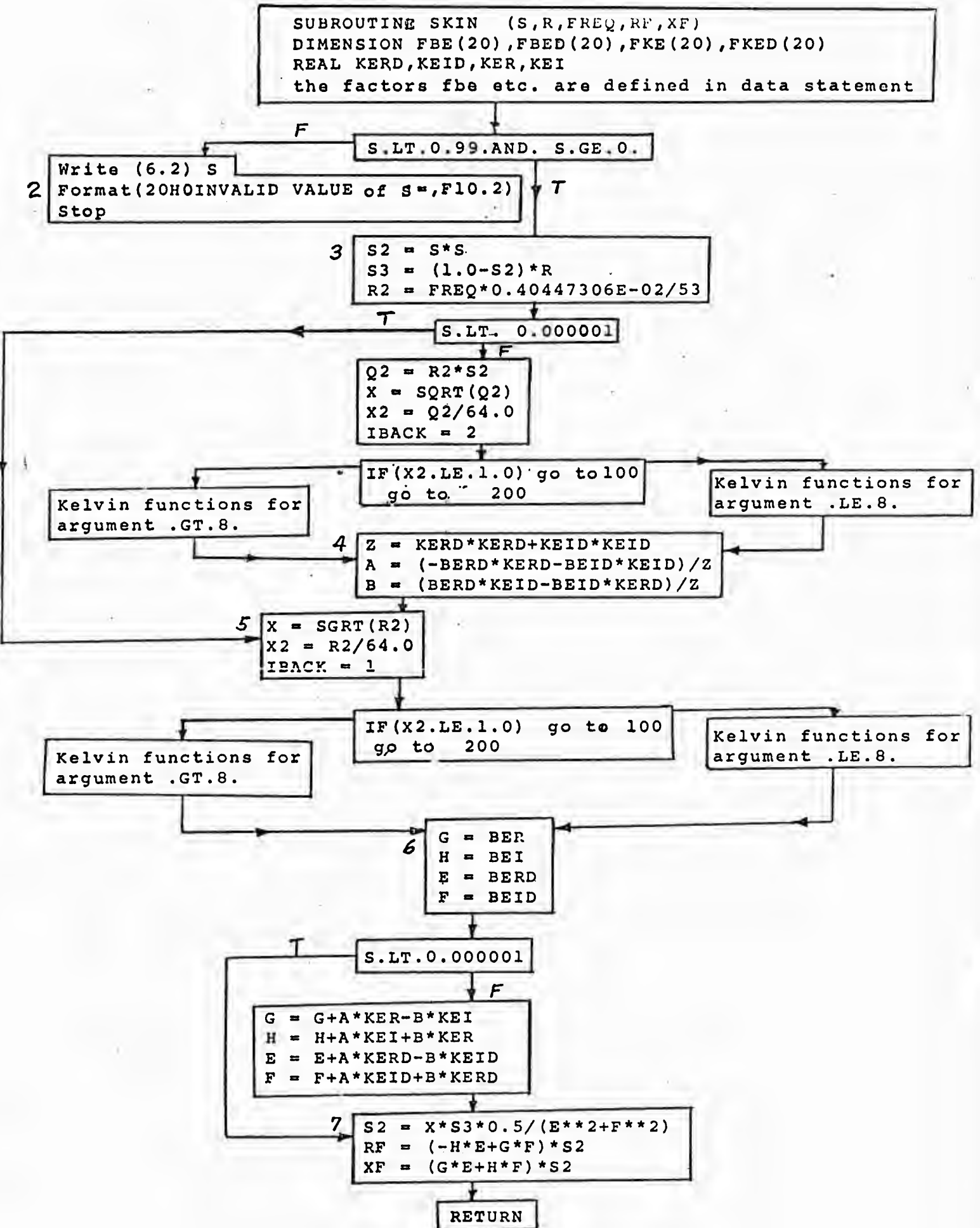

C CALCULATION OF KELVIN-FUNCTIONS FOR ARGUMENT .LE.8.

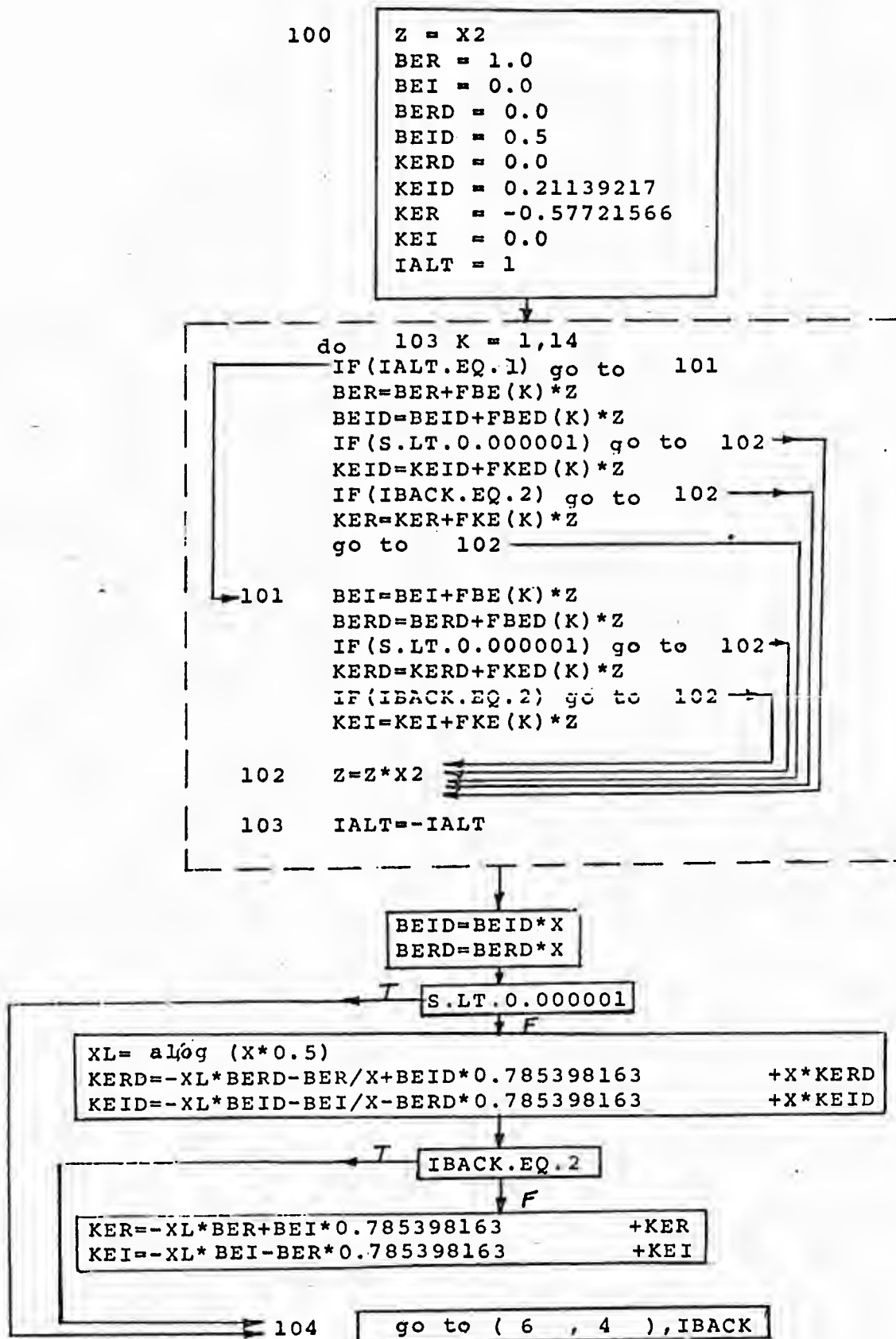

C CALCULATIONS OF KELVIN-FUNCTIONS FOR ARGUMENT.GT.8

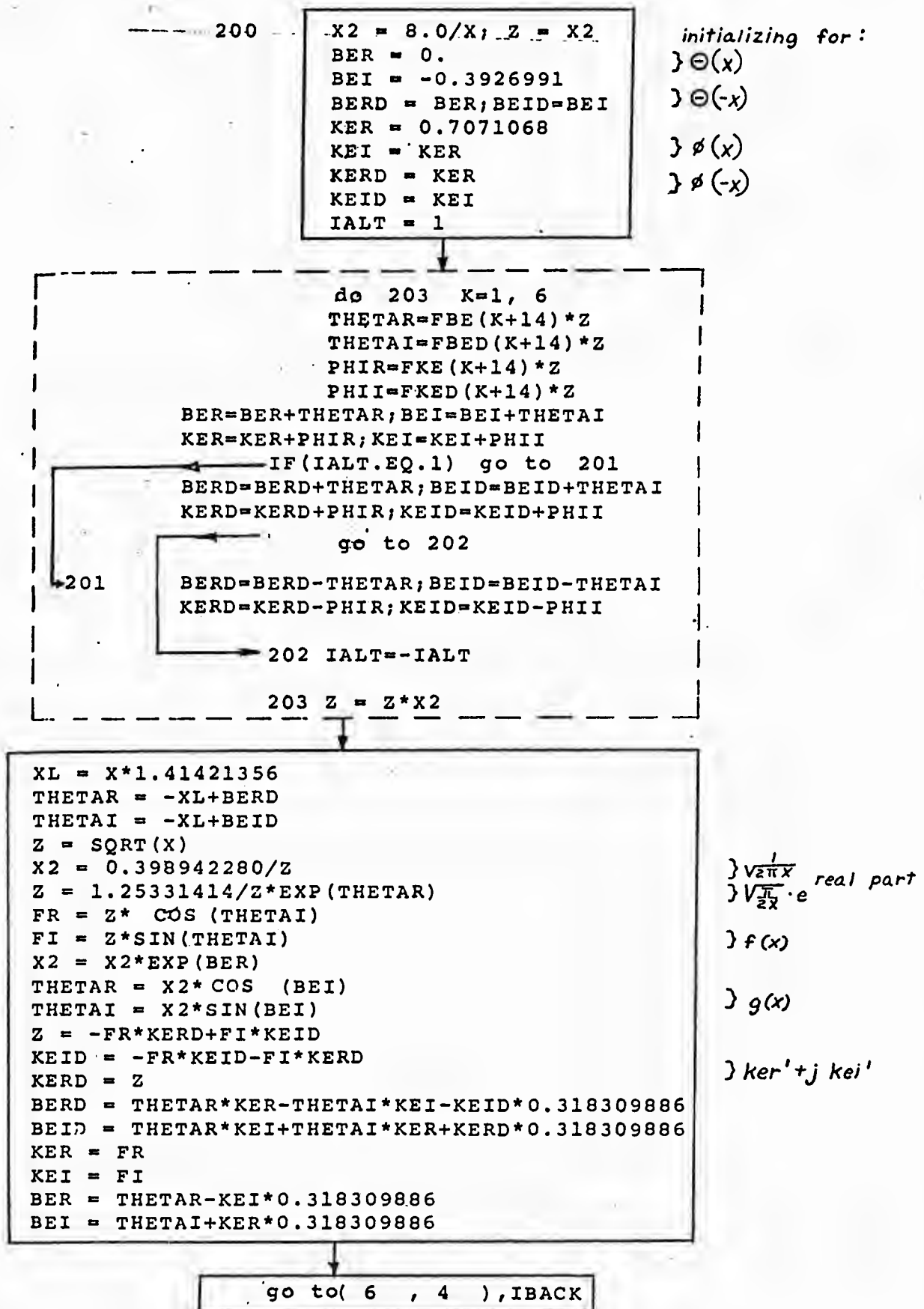

APPENDIX 3

Note on Attenuation in Overhead Lines

- References: [1] Goldstein, A.: "Propagation Characteristics of Power Line Carrier Links," Brown-Boveri Review, Vol. 35, 1948, P. 266.
- [2] Galloway, R. H., W. B. Shomocks, and L. M. Wedepohl: "Calculation of Electrical Parameters for Short and Long Polyphase Transmission Lines", Proc. IEE (London), Vol. 111, No. 12, pp. 2051-2059, December 1964.
- [3] User's Manual for Line Constants. Memo of the Methods Analysis Group.

Reference 1 contains measurements and approximate formulas for the attenuation on an untransposed line. The values were re-computed in reference 2 with more accurate formulas.

The same case was run with BPA's line constants program (reference 3); a slight modification was made to handle $\mu = 1000$ in the earth wire (the normal program version assumes $\mu = 1$). Also, the positive sequence data were considered to be close enough to the data of mode-2- propagation (one of 3 independent modes; mode 2 not associated with ground return) of reference 2. The modes could be found by an eigenvalue analysis; this is not included in the line-constants-program as of now.

BPA's line constants program neglects stranding and assumes a round conductor (or tubular when the steel core of an ACSR is ignored). When Galloway's formula for the internal impedance of stranded conductors is used, then BPA results come very close to measurements. Unfortunately, Galloway's formula contains a factor which must be found from measurements in an electrolytic tank. Galloway says that his factor of 2.25 is satisfactory for the number of outer strands being 6, 12, 18 or 24 and for frequencies above 2-5 KHz. It was also tried to treat each strand as an individual conductor and bundle them. The results were unsatisfactory (lay in neighborhood of approximate formula of reference 1); this is probably due to high proximity effects which are not taken into account in the line constants program.

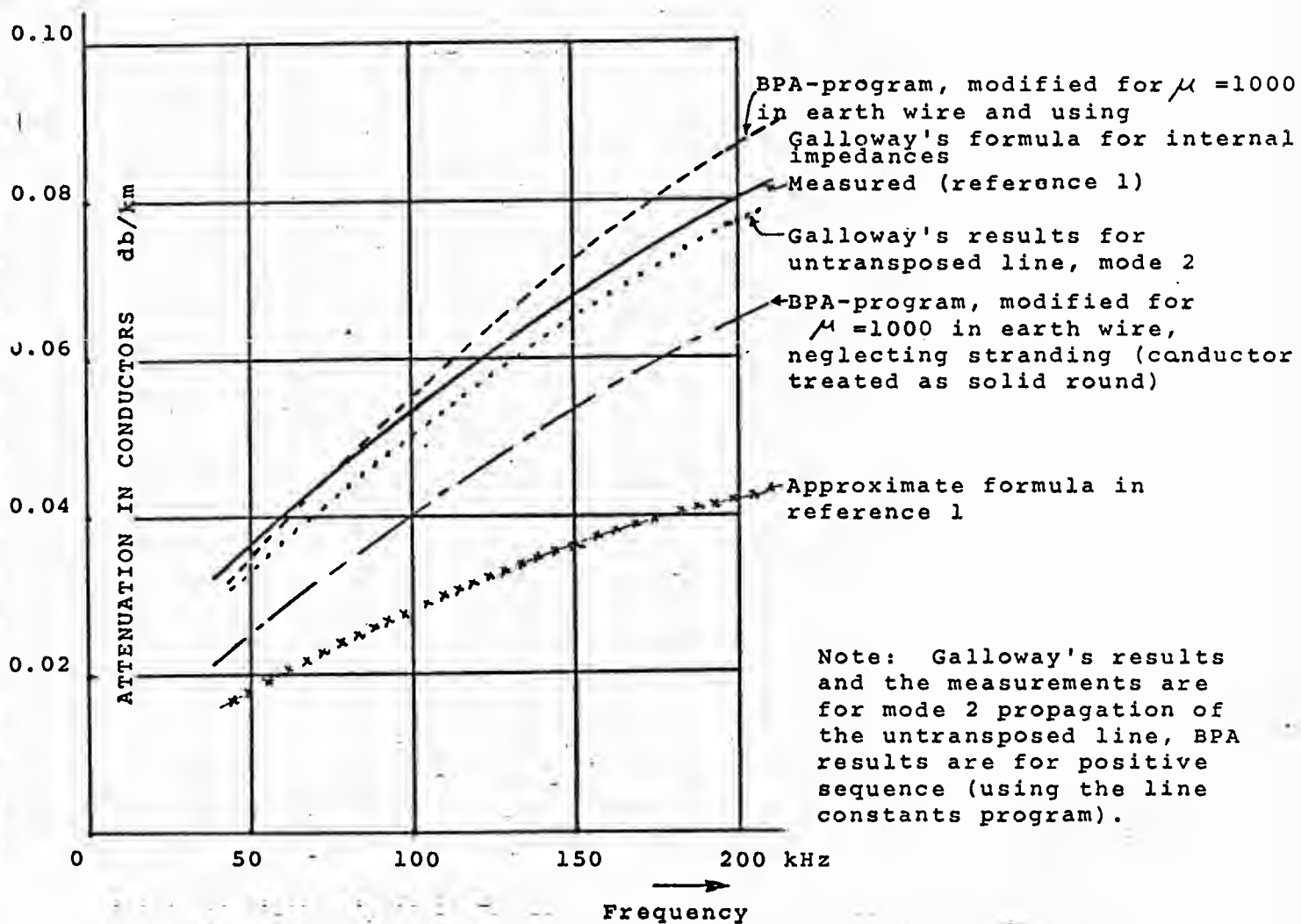

Appendix 4. Matrix reduction and matrix inversionExplanation of matrix reduction

Given a system of linear equations:

$$[A][x] = [b]$$

with $[A] = n \times n$ matrix

$[x], [b]$ = vectors with n components.

Let the components in the vectors be subdivided into 2 subsets 1 and 2.
With the corresponding subdivision in the matrices we get

$[A_{11}]$	$[A_{12}]$	$[x_1]$	=	$[b_1]$
$[A_{21}]$	$[A_{22}]$	$[x_2]$		$[b_2]$

$$[A_{11}][x_1] + [A_{12}][x_2] = [b_1] \quad (\text{IV}, 1)$$

$$\text{or } [A_{21}][x_1] + [A_{22}][x_2] = [b_2] \quad (\text{IV}, 2)$$

The objective is to arrive at a reduced system of equations for subset 1. This is accomplished by solving (IV,2) for $[x_2]$,

$$-[A_{22}]^{-1}[A_{21}][x_1] + [A_{22}]^{-1}[b_2] = [x_2] \quad (\text{IV}, 3)$$

and inserting this into (IV,1), which becomes

$$[A_{11}^{\text{reduced}}][x_1] = [b_1] + [D_{12}][b_2] \quad (\text{IV}, 4)$$

with the reduced matrix $[A_{11}^{\text{reduced}}] = [A_{11}] - [A_{12}][A_{22}]^{-1}[A_{21}]$
(sometimes called "Kron's reduction formula")

and the distribution factor matrix

$$[D_{12}] = -[A_{12}][A_{22}]^{-1}$$

Eq. (IV,4) becomes quite simple if $[b_2] = 0$. In this case

$$[A_{11}^{\text{reduced}}][x_1] = [b_1] \quad \text{if } [b_2] = 0 \quad (\text{IV}, 5)$$

Whenever equations are to be reduced in this text, they will first be brought into a form where $[b_2] = 0$ to arrive at the simple reduced system (IV,5) where no distribution factors are necessary.

The computation is carried out by exchanging - one at a time - the variables $x_n, b_n, x_{n-1}, b_{n-1} \dots, x_{m+1}, b_{m+1}$. In eq. (IV,3) this has been done for the entire "block" 2. To retain symmetry in the matrix throughout this process, the right-hand sides b_i are redefined with a negative sign, or $[A] [X] = - [b]^*$. If variables x_j, b_j are to be exchanged (that is x_{j+1}, b_{j+1} etc. have already been exchanged) and the coefficients from the last exchange are $a_{jk}^{(old)}$ then:

$$a_{j1}^{(old)} x_1 + a_{j2}^{(old)} x_2 + \dots + a_{jj}^{(old)} x_j + a_{j(j+1)}^{(old)} b_{j+1} + \dots + a_{jn}^{(old)} b_n = -b_j \quad (IV, 6a)$$

and x_j, b_j exchanged:

$$-\frac{a_{j1}^{(old)}}{a_{jj}^{(old)}} x_1 - \frac{a_{j2}^{(old)}}{a_{jj}^{(old)}} x_2 - \dots - \frac{1}{a_{jj}^{(old)}} b_j - \frac{a_{j(j+1)}^{(old)}}{a_{jj}^{(old)}} b_{j+1} - \dots - \frac{a_{jn}^{(old)}}{a_{jj}^{(old)}} b_n = x_j \quad (IV, 6b)$$

If (IV,6b) is rewritten with the new coefficients,

$$a_{j1}^{(new)} x_1 + \dots = x_j,$$

then it follows that

$$\text{for the eliminated row: } a_{jk}^{(new)} = -\frac{a_{jk}^{(old)}}{a_{jj}^{(old)}} \text{ for } k \neq j \text{ and } a_{jj}^{(new)} = -\frac{1}{a_{jj}^{(old)}} \quad (IV, 7)$$

By insertion (IV,6b) in the other equations one gets

$$\text{for the other rows: } a_{ik}^{(new)} = a_{ik}^{(old)} - a_{ij}^{(old)} \cdot \frac{a_{jk}^{(old)}}{a_{jj}^{(old)}} \text{ for } k \neq j \quad (IV, 8)$$

$$\text{and } a_{ij}^{(new)} = -\frac{a_{ij}^{(old)}}{a_{jj}^{(old)}} \quad (IV, 9)$$

By comparing eq. (IV,7) and (IV,9) it can be seen that the symmetry is retained.

Matrix is stored as upper triangle:



$IJ+I, I=1,2,\dots$
Address of a_{jj}

$IK+I, I=1,2,\dots$
Address of a_{ik}

*) The negative sign on b_1 accounts for the fact that the process leads to the negative inverse matrix.

Matrix is reduced from size N to size M. Variables X_{m+1}, \dots, X_n are eliminated. If $M=0$: result is negative inverse matrix.

Note: The reduction or inversion process yields the system of equations

$$\begin{bmatrix} [A_{11} \text{ reduced}] & -[D_{12}] \\ -[D_{12}]^T & [A_{22}]^{-1} \end{bmatrix} \begin{bmatrix} [X_1] \\ [X_2] \end{bmatrix} = \begin{bmatrix} [b_1] \\ [b_2] \end{bmatrix}$$

and replaces the original matrix with the one shown at left. In case of reduction ($M > 0$) only

$[A_{11} \text{ reduced}]$ is normally produced. If the other submatrices

$-[D_{12}]^T$ and $[A_{22}]^{-1}$ are also desired, then leave out the shaded statement as indicated below.

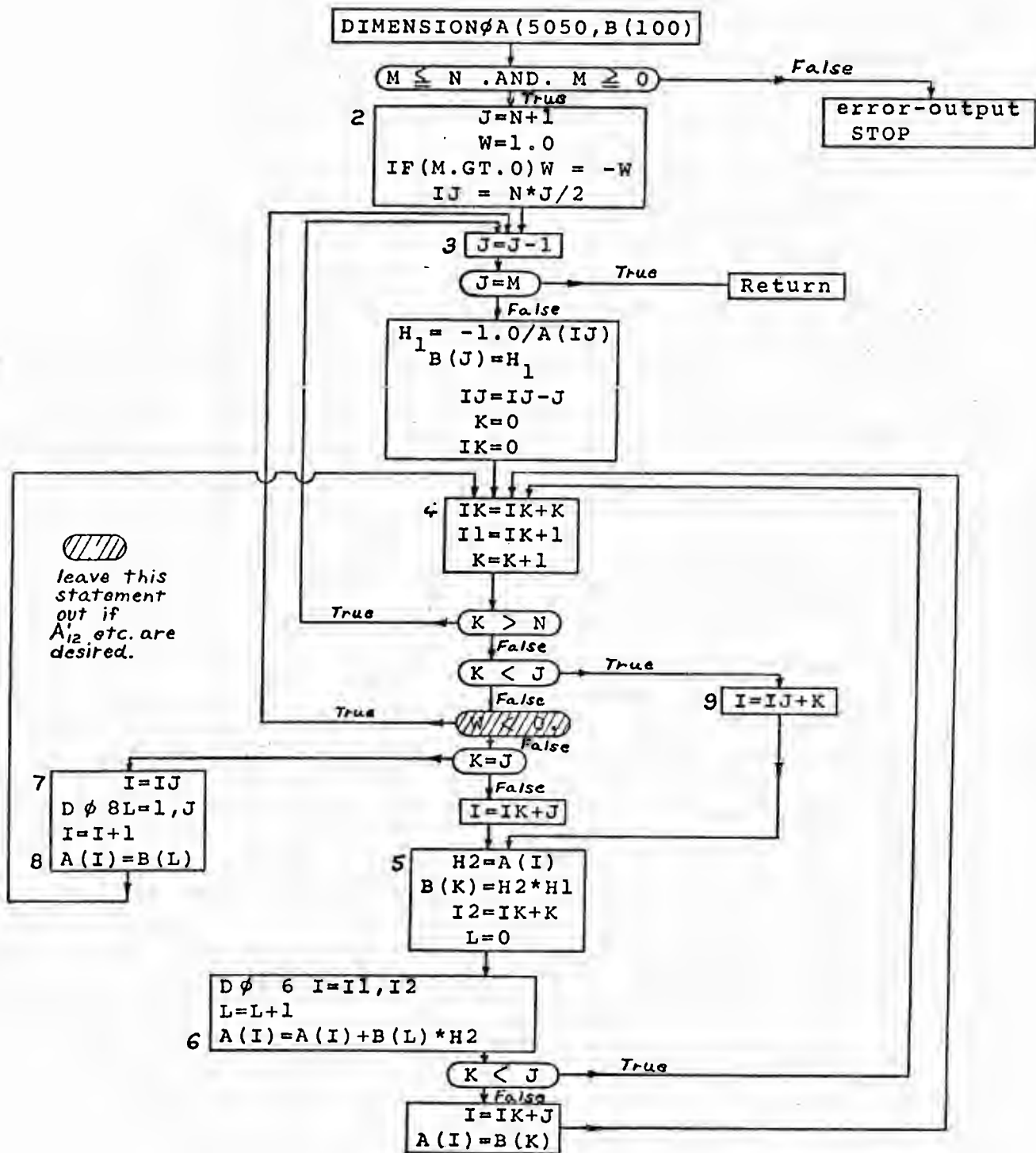

Appendix 5

Transposition of Double Circuits1. Double circuit, transposition scheme of 9 sections

A perfect decoupling of the sequence quantities within each 3-phase circuit and also a decoupling between the 2 circuits except for the zero sequence is reached by the following transposition scheme:

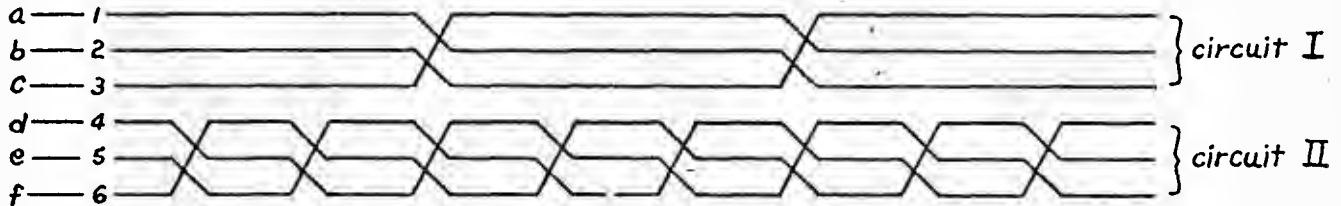

The symmetrical component matrix will have zero elements except for:

$$\begin{array}{lll} Z'_{\text{zero-I}} & Z'_{\text{zero-II}} & \text{and } Z'_{\text{zero-I/II}} \\ Z'_{\text{pos.-I}} & Z'_{\text{pos.-II}} & \\ Z'_{\text{neg.-I}} & Z'_{\text{neg.-II}} & \end{array}$$

There is no cross-coupling from one sequence to another and also no coupling within the same sequence between the 2 circuits except in the zero-sequence.

Using the same approach of adding the voltage drops for all sections, one gets

$$\begin{aligned} [Z'_{\text{phase}}] &= \frac{1}{9} \left\{ [Z'_{\text{phase of 1st section}}] + [Z'_{\text{phase of 2nd section}}] + \dots + [Z'_{\text{phase of 9th section}}] \right\} \\ &= \frac{1}{9} \begin{bmatrix} 3Z'_{BI} & 3Z'_{AI} & 3Z'_{AI} & Z'_c & Z'_c & Z'_c \\ 3Z'_{AI} & 3Z'_{BI} & 3Z'_{AI} & Z'_c & Z'_c & Z'_c \\ 3Z'_{AI} & 3Z'_{AI} & 3Z'_{BI} & Z'_c & Z'_c & Z'_c \\ \hline Z'_c & Z'_c & Z'_c & 3Z'_{BH} & 3Z'_{AH} & 3Z'_{AH} \\ Z'_c & Z'_c & Z'_c & 3Z'_{AH} & 3Z'_{BH} & 3Z'_{AH} \\ Z'_c & Z'_c & Z'_c & 3Z'_{AH} & 3Z'_{AH} & 3Z'_{BH} \end{bmatrix} \end{aligned}$$

$$\begin{aligned} \text{with } Z'_{AI} &= Z'_{12} + Z'_{23} + Z'_{31} & Z'_{AII} &= Z'_{45} + Z'_{56} + Z'_{64} \\ Z'_{BI} &= Z'_{11} + Z'_{22} + Z'_{33} & Z'_{BII} &= Z'_{44} + Z'_{55} + Z'_{66} \end{aligned}$$

$$\begin{aligned} \text{and } Z'_c &= Z'_{14} + Z'_{15} + Z'_{16} + Z'_{24} + Z'_{25} + Z'_{26} + Z'_{34} + Z'_{35} + Z'_{36} \\ &\text{bearing in mind that } Z'_{ik} = Z'_{ki} \end{aligned}$$

Transforming into symmetrical components yields:

$$[Z'_{symm.}] = \begin{bmatrix} S' & 0 \\ 0 & S^{-1} \end{bmatrix} \cdot [Z'_{phase}] \cdot \begin{bmatrix} S & 0 \\ 0 & S \end{bmatrix}$$

$$= \left[\begin{array}{ccc|ccc} \frac{Z'_{AI} + 2Z'_{AI}}{3} & 0 & 0 & \frac{Z'_C}{3} & 0 & 0 \\ 0 & \frac{Z'_{AI} - Z'_{AI}}{3} & 0 & 0 & 0 & 0 \\ 0 & 0 & \frac{Z'_{BI} - Z'_{AI}}{3} & 0 & 0 & 0 \\ \hline \frac{Z'_C}{3} & 0 & 0 & \frac{Z'_{BI} + 2Z'_{AI}}{3} & 0 & 0 \\ 0 & 0 & 0 & 0 & \frac{Z'_{BI} - Z'_{AI}}{3} & 0 \\ 0 & 0 & 0 & 0 & 0 & \frac{Z'_{BI} - Z'_{AI}}{3} \end{array} \right] \quad (V,1)$$

It can easily be verified that the non-zero elements in (V,3) come out identically when the line-constants program for untransposed configuration is used. Therefore, again simply

ignore the terms in the untransposed series impedance and shunt capacitance matrices for the symmetrical components in the places of zero-entries in (V,3) to account for the transposition effect

2. Double Circuit, Transposition in 3 Sections in Opposite Direction

The cross-coupling from one sequence to another can also be avoided by a much simpler transposition scheme with rotation in opposite direction. It leaves coupling within the same sequence between the 2 circuits however.

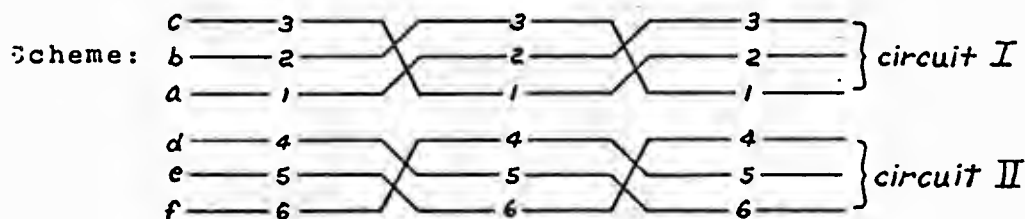

Note that the conductors are numbered in the order of the phases a, b, c and d, e, f in the first section

First find

$$[Z'_{\text{phase}}] = \frac{1}{3}$$

$$\left[\begin{array}{ccc|ccc} Z'_{BI} & Z'_{AI} & Z'_{AI} & Z'_K & Z'_L & Z'_M \\ Z'_{AI} & Z'_{BI} & Z'_{AI} & Z'_M & Z'_K & Z'_L \\ Z'_{AI} & Z'_{AI} & Z'_{BI} & Z'_L & Z'_M & Z'_K \\ \hline Z'_K & Z'_M & Z'_L & Z'_{BII} & Z'_{AII} & Z'_{AII} \\ Z'_L & Z'_K & Z'_M & Z'_{AII} & Z'_{BII} & Z'_{AII} \\ Z'_M & Z'_L & Z'_K & Z'_{AII} & Z'_{AII} & Z'_{BII} \end{array} \right] \quad (V, 4)$$

$$\begin{aligned} \text{with } Z'_{AI} &= Z'_{12} + Z'_{23} + Z'_{31} & Z'_{AII} &= Z'_{45} + Z'_{56} + Z'_{64} \\ Z'_{BI} &= Z'_{11} + Z'_{22} + Z'_{33} & Z'_{BII} &= Z'_{44} + Z'_{55} + Z'_{66} \end{aligned} \quad (V, 5)$$

$$\begin{aligned} Z'_K &= Z'_{14} + Z'_{25} + Z'_{36} \\ Z'_L &= Z'_{15} + Z'_{26} + Z'_{34} \\ Z'_M &= Z'_{16} + Z'_{24} + Z'_{35} \end{aligned} \quad \begin{array}{l} Z'_L = Z'_M \text{ of same} \\ \text{configuration in} \\ \text{both circuits} \end{array}$$

Then transforming into symmetrical components yields:

$$[Z'_{\text{symm.}}] = \begin{bmatrix} S' & 0 \\ 0 & S^{-1} \end{bmatrix} \cdot [Z'_{\text{phase}}] \cdot \begin{bmatrix} S & 0 \\ 0 & S \end{bmatrix}$$

$$[Z'_{\text{symm.}}] = \left[\begin{array}{ccc|ccc} \frac{Z'_{BI} + 2Z'_{AI}}{3} & 0 & 0 & \frac{Z'_K + Z'_L + Z'_M}{3} & 0 & 0 \\ 0 & \frac{Z'_{BI} - Z'_{AI}}{3} & 0 & 0 & \frac{Z'_K + a^2 Z'_L + a Z'_M}{3} & 0 \\ 0 & 0 & \frac{Z'_{BI} - Z'_{AI}}{3} & 0 & 0 & \frac{Z'_K + a Z'_L + a^2 Z'_M}{3} \\ \hline \frac{Z'_K + Z'_L + Z'_M}{3} & 0 & 0 & \frac{Z'_{BI} + 2Z'_{AI}}{3} & 0 & 0 \\ 0 & \frac{Z'_K + a Z'_L + a^2 Z'_M}{3} & 0 & 0 & \frac{Z'_{BI} - Z'_{AI}}{3} & 0 \\ 0 & 0 & \frac{Z'_K + a^2 Z'_L + a Z'_M}{3} & 0 & 0 & \frac{Z'_{BI} - Z'_{AI}}{3} \end{array} \right]$$

Eq. (V,6) shows that within each sequence there is coupling from one circuit (I) to the other (II). Theoretically $Z'_{\text{pos. I-II}} = Z'_{\text{pos. II-I}}$ (same true for negative sequence coupling from I to II), however, in practical cases the conductor arrangement is likely to be symmetric with respect to the tower

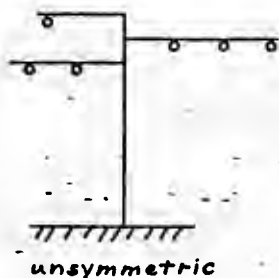
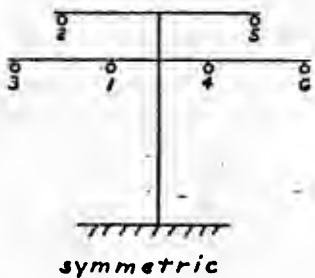

For symmetric arrangement:

$$Z'_L = Z'_M \text{ and therefore:}$$

$$\begin{aligned} Z'_{\text{pos. I-II}} &= Z'_{\text{pos. II-I}} = \\ &= Z'_{\text{neg. I-II}} = Z'_{\text{neg. II-I}} = \frac{Z'_K - Z'_L}{3} \end{aligned}$$

Again it can easily be verified that the line-constants program for untransposed configuration yields the same values in the non-zero entries in (V,6).

Verification by computing

$$\begin{bmatrix} S^{-1} & 0 \\ 0 & S^{-1} \end{bmatrix} \cdot \begin{bmatrix} Z'_{11} & Z'_{12} & Z'_{13} & \dots & Z'_{16} \\ Z'_{21} & Z'_{22} & Z'_{23} & \dots & Z'_{26} \\ Z'_{61} & Z'_{62} & Z'_{63} & \dots & Z'_{66} \end{bmatrix} \begin{bmatrix} S & 0 \\ 0 & S \end{bmatrix}$$

Therefore again simply

ignore the terms in the untransposed series impedance and shunt capacitance matrices for the symmetrical components in the places of zero-entries in (V,6) to account for the transposition effect.

Attention: Number phases as in first section to express opposite directions for transpositions

Appendix 6

Series Connection of Two Identical Equivalent multi- π 's

The series connection of two identical multi- π 's (Fig. 7, p. 21) is described by the equations

$$\begin{bmatrix} [Y_{11}] & 0 & [Y_{12}] \\ 0 & [Y_{11}] & [Y_{12}] \\ [Y_{12}] & [Y_{12}] & 2[Y_{11}] \end{bmatrix} \begin{bmatrix} [V_1] \\ [V_2] \\ [V_3] \end{bmatrix} = \begin{bmatrix} [I_1] \\ [I_2] \\ 0 \end{bmatrix} \quad (40)$$

with $[Y_{11}] = [Y_{\text{transfer}}] + [Y_{\text{shunt}}]$ and $[Y_{12}] = -[Y_{\text{transfer}}]$. (41)

The elimination of the node voltages in ③ yields:

$$\begin{bmatrix} [Y_{11}^{\text{double}}] & [Y_{12}^{\text{double}}] \\ [Y_{12}^{\text{double}}] & [Y_{11}^{\text{double}}] \end{bmatrix} \times \begin{bmatrix} [V_1] \\ [V_2] \end{bmatrix} = \begin{bmatrix} [I_1] \\ [I_2] \end{bmatrix} \quad (42)$$

with $[Y_{12}^{\text{double}}] = -1/2 [Y_{12}] [Y_{11}]^{-1} [Y_{12}]$ (43)

$$[Y_{11}^{\text{double}}] = [Y_{11}] + [Y_{12}^{\text{double}}].$$

Because of the structure of (40), it is possible to carry out the elimination in a $2M \times 2M$ matrix instead of a $3M \times 3M$ matrix. To do this, take the system

$$\begin{bmatrix} [Y_{11}] & [Y_{12}] \\ [Y_{12}] & 2[Y_{11}] \end{bmatrix} \times \begin{bmatrix} [X_1] \\ [X_2] \end{bmatrix} = \begin{bmatrix} [Y_1] \\ 0 \end{bmatrix} \quad (44)$$

and eliminate $[X_2]$, which yields

$$\left\{ [Y_{11}] - 1/2 [Y_{12}] [Y_{11}]^{-1} [Y_{12}] \right\} [X_1] = [Y_1] \quad (45)$$

This is the desired matrix $[Y_{11}^{\text{double}}]$. Then $[Y_{12}^{\text{double}}]$ is simply the difference

$$[Y_{12}^{\text{double}}] = [Y_{11}^{\text{double}}] - [Y_{11}] \quad (46)$$

Appendix 7

Choice of Incremental Length ΔS

The incremental length ΔS for the initial equivalent of eq. (27) must be chosen small enough to justify the use of eq. (29); that is an upper bound, based on the comparison of ΔS with the wave length, must be observed. There is also a lower bound, determined by round-off problems, which must be observed. This lower bound is estimated pragmatically in the following way:

As seen in (40) of appendix 6, a sum

$$[Y_{\text{transfer}}] + [Y_{\text{shunt}}]$$

enters the admittance matrix, with each term found from eq. (29). Clearly, the first term gets larger and larger as ΔS decreased and the second term gets smaller and smaller as ΔS decreases. Because of the finite number of digits in a computer, $[Y_{\text{shunt}}]$ would finally get lost in the summation if ΔS is too small (with $Y_{\text{transfer}} = 1$ and $Y_{\text{shunt}} = 10^{-8}$ a 6-digit-computer would lose Y_{shunt} and give $Y_{\text{transfer}} + Y_{\text{shunt}} = 1$).

From experiments on an IBM 7040 (with about 9 significant decimal digits) a good choice of ΔS was a value that makes $Y_{\text{shunt}} \approx 0.5 \cdot 10^{-3} Y_{\text{transfer}}$. This choice avoids the loss of too many significant digits in Y_{shunt} in the summation and also avoids an excessive number of doubling procedures in getting the equivalent for the total length, which is also a source of round-off errors. For the general case of multiphase lines (including the single-phase line), values ΔS_i are found from comparison of the diagonals only, in the equation,

$$Y_{ii \text{ shunt}} = 0.5 \cdot 10^{-3} \cdot Y_{ii \text{ transfer}}, \text{ from which the}$$

smallest value is selected as a first guess, $\Delta S_{\text{guess}} = \min \{\Delta S_i\}$.
 Since the successive doubling should lead to the exact length S ,
 the value used for ΔS is the value ΔS_{guess} decreased until

$$\Delta S \times (\text{power of } 2) = S.$$

Example: Three-phase line with $S=800$ miles, $\Delta S_1 = 9.5$,

$\Delta S_2 = 8$, $\Delta S_3 = 10.2$ miles, then $\Delta S_{\text{guess}} = 8$ miles, then

$\Delta S = 6.25$ miles. For 60 Hz ΔS is usually of the order of
 10 miles with this procedure.

REFERENCES

1. D. Coleman, F. Watts, and R.B. Shipley, "Digital calculation of overhead-transmission-line constants," AIEE Trans., pt. III (Power Apparatus and Systems), vol.77, pp. 1266-1270, 1958.
2. M.H. Hesse, "Electromagnetic and electrostatic transmission-line parameters by digital computer," IEEE Trans. Power Apparatus and Systems, vol.82, pp. 282-290, 1963.
3. R.B. Shipley, and D.W. Coleman, "A new direct matrix inversion method," AIEE Trans., pt.I (Commun. and Electronics), vol.78, pp. 568-572, 1959.
4. W.I. Bowman, and J.M. McNamee, "Development of equivalent Pi and T matrix circuits for long untransposed transmission lines," IEEE Trans. Power Apparatus and Systems, vol.83, pp. 625-632, discussion pp. 653-657, 1964.
5. E. Bodewig, Matrix Calculus, 2nd edition. Amsterdam: North-Holland Publishing Co., 1959, p. 115.
6. E. Clarke, Circuit Analysis of A-C Power Systems, vol.I. New York: John Wiley and Sons, 1943, p. 457.
7. W.S. Meyer and H.W. Dommel, "Telephone-interference calculation for multiconductor power lines," IEEE Trans. Power Apparatus and Systems, vol.88, pp. 35-41, January 1969.
8. J.G.F. Francis, "The QR transformation," Computer Journal, Vol.4, pp. 332-345, 1961.
9. J.H. Wilkinson, The Algebraic Eigenvalue Problem. London: Oxford University Press, 1965.
10. M.C. Perz, "Natural modes of power line carrier on horizontal three-phase lines," IEEE Trans. Power Apparatus and Systems, vol.83, pp. 679-686, discussion pp. 748-754, 1964.
11. M.C. Perz, "A method of analysis of power line carrier problems on three-phase lines," IEEE Trans. Power Apparatus and Systems, vol.83, pp. 686-691, discussion pp. 754-756, 1964.
12. J.R. Carson, "Wave propagation in overhead wires with ground return," Bell System Technical Journal, vol.5, pp. 539-554, 1926.
13. S. Butterworth, Electrical characteristics of overhead lines, El. Research Association, Techn. Report Ref. O/74, 1954.
14. A.E. Kennelly, F.A. Laws, and P.H. Pierce, "Experimental research on skin effect in conductors," AIEE Trans., pt.II, vol.34, pp. 1953-2018, 1915.
15. H.B. Dwight, Electrical Coils and Conductors. New York: McGraw Hill Book Co., 1945, p. 171 or:

- N.W. McLachlan, Bessel Functions for Engineers. Oxford: Clarendon Press, 1955, p. 176.
16. Handbook of Mathematical Functions. Edited by M. Abramowitz and I.A. Stegun, publ. by US Dept. of Commerce, 1964, pp. 384-385 (note: for arguments x greater than the functions are better multiplied by $\exp\left(\frac{-1+j}{\sqrt{2}}x\right)$ to avoid too large numbers).
 17. L.M. Wedepohl, "Electric characteristics of polyphase transmission systems with special reference to boundary-value calculations at power-line carrier frequencies," Proc. IEE, vol.112, pp. 2103-2112, 1965.
 18. O. Nigol, "Analysis of radio noise from high-voltage lines (II) - Propagation theory," IEEE Trans. Power Apparatus and Systems, vol.83, pp. 533-541, discussion pp. 554-558, 1964.
 19. L.M. Wedepohl, and J.N. Saha, "Radio-interference fields in multi-conductor overhead transmission lines," Proc. IEE, vol.116, pp. 1875-1884, November 1969.
 20. L.M. Wedepohl, "Application of matrix methods to the solution of travelling-wave phenomena in polyphase systems," Proc. IEE, vol.110, pp. 2200-2212, December 1963.
 21. H. Holley, D. Coleman, and R.B. Stippley, "Untransposed EHV line computations," IEEE Trans. Power Apparatus and Systems, vol.83, pp. 291-296, discussion pp. 300-304, 1964.
 22. EHV Transmission Line Reference Book. New York: Edison Electric Institute, 1968.

7.5 "SEMLYEN SETUP" Routine

By means of the special request word "SEMLYEN SETUP", an EMTF user gains access to the supporting routine which bears this same name, as per the explanation of Section 7. The principal function of this code is to punch the branch cards which are needed for the representation of a transmission circuit using Semlyen Recursive Convolution modeling. See Section 1.27

Note : The "SEMLYEN SETUP" code which is now to be described is essentially the same as in November of 1977 (time of "M21." versions). Representation of the propagation response and the admittance response is limited to just two real exponentials each, and time-domain fitting is used. On the other hand, the solution mathematics of Section 1.27 allow an arbitrary number of complex exponentials. The old "SEMLYEN SETUP" overlay has simply been interfaced with the new simulation code, so that it can continue to be used. Read further perspective at the very end of this section (page 215).

7.5-A Structure of "SEMLYEN SETUP" data deck

Suppose that the user wants to use the "SEMLYEN SETUP" routine. His input data cards are then to be structured as follows:

- S1. First comes a "BEGIN NEW DATA CASE" card (actually optional, as per Section 1.0a).
- S2. Next comes a "SEMLYEN SETUP" card, which serves to transfer control to the overlay in question (UTPF overlay number 45).
- S3. Next come optional special-request cards (if any), in arbitrary order. Such data cards are recognized by usage of one of the following special-request words which begin in column number 1:
 - a) "BRANCH" ----- to name the nodes (A6 information) at each end of each phase of the transmission circuit.
 - b) "TOLERANCES" -- to redefine one or more of the numerous "constants" which control the logic of this routine.
- S4. Next comes a miscellaneous data card.
- S5. Next come three extensions to the miscellaneous data card, if and only if miscellaneous data parameter "IOTX" was given the value -1. These three cards (if so used) provide an expanded format for redefinition of the miscellaneous data parameters "IOTX", "IOSS", and "IOFL".
- S6. One single, complete data case for "LINE CONSTANTS" or "CABEL CONSTANTS". The first card of this grouping must read "LINE CONSTANTS" or "CABLE CONSTANTS"; two blank cards will end the grouping (the first to end frequency cards, and the second to end data cases within the supporting program in question). The frequency cards should be prepared according the following order and rules:

Untransposed line (or cable) --- THREE frequency cards are needed:

1. The first frequency card is for the calculation of the modal-phase domain transformation matrix at a specified frequency FREQ. The default value for FREQ is set to be 5000 Hz. To calculate this transformation matrix at a frequency other than 5000 Hz, one needs to enter the desired value in the field of FREQ on this frequency card, and to redefine FREQ with this same value on the "TOLERANCES" card (see section 7.5-B).
2. The second frequency card is for the steady state frequency at which the resulting line (or cable) model is to be used. This is usually 50 Hz or 60 Hz for ac systems. For dc systems, use some small value such as .001 Hz.
3. The third frequency card is to request the logarithmic looping over all frequencies which are required by the inverse Fourier transformation of "SEMLYEN SETUP". Typically this will provide for 20 points per decade, beginning at 1 Hz and ending at 10^7 Hz.

Transposed line (or cable) --- Only TWO , namely the second and the third of the aforementioned frequency cards are needed.

S7. Repeat the data of Point S3 through Point S6 as often as is desired. Each such grouping represents a separate data case within "SEMLYEN SETUP".

Actually, the cards of Point S6 are to be omitted in such a data grouping if and only if either the "NEW RHO" or the "OLD DATA" option is being used. In such cases, the geometrical data of the transmission circuit is "remembered" from the preceding data case within "SEMLYEN SETUP". By using one of these options, as few as a single data card can constitute a data case within "SEMLYEN SETUP" (only the miscellaneous data card is mandatory).

S8. If the user wants to shut the EMTP off at this point (rather than execute a following EMTP data case), he should simply add a "BEGIN NEW DATA CASE" card at this point, followed by a blank card. This is as per Section 1.0b.

7.5-B Format for data cards of "SEMLYEN SETUP"

1) "BRANCH" card (Point S3-a data)

BRANCH	A6	A6	A6	A6	Etc.
	BUS1	BUS2	BUS1	BUS2	BUS1 — BUS2
	Phase #1		Phase #2		

Enter pair of node names for each phase of line. "BUS1" field is always for the same end

This data card is distinguished by the key word "BRANCH" which is punched in columns 1-6. The card is completely optional in that numerical values generated within "SEMLYEN SETUP" are unaffected by the presence or absence of it. The "BRANCH" card merely allows the user to specify pairs of 6-character node names which will be reproduced in columns 3-14 (fields "BUS1" and "BUS2", each A6 format) of the EMTP branch cards which will be punched as output. Without such a "BRANCH" card, columns 3-14 of the branch cards which are to be punched as output will be blank.

2) "TOLERANCES" card (Point S3-b data)

TOLERANCES	field #1	field #2	field #3	field #4	field #5
	Index value	Index value	Index value	Index value	Index value
	12 E11.0	12 E11.0	12 E11.0	12 E11.0	12 E11.0

The iterative procedures of "SEMLYEN SETUP" are controlled by 18 different near-zero tolerances, iteration limits, and the like. If no "TOLERANCES" card is supplied, built-in default values will be used, as per the following tabulation:

Index number	Variable name	Default value	Usage of variable within "SEMLYEN SETUP"
1	EPS	.005	Maximum least-square error
2	EPS1	.005	Maximum relative error of a_i or λ_i
3	FIT2Z	.1	"beginning" of time-step-response sequence
4	PIVTHR	1.E-5	Least squares minimum Jacobian pivot magnitude.
5	EPSRSE	.01	
6		.9	
7	FT2EMX	1.E-4	Maximum steady-state error.
8	EPSEIG	1.E-7	Convergence tolerance for eigenvalue calculation.
9	EPSPV2	1.E-16	Minimum size for squared pivot element, within inversion routine.
10	FMED	5000.	Frequency in Hz of the 2nd point of Y_c .
11	EPSYC	1.E-3	Maximum relative error, for the characteristic admittance fitting procedure.
12	EPSN	1.E-3	Maximum total error for the characteristic admittance fitting.
13	FFINP	1.0	Final value of time-domain fitted step response.
14	NFIT	10.	Maximum number of iterations for Δt selection.
15	NITER1	10.	Maximum number of iterations for steady-state fitting.
16	NITER	10.	Maximum number of iterations for least squares fitting.
17	NITERY	10.	Maximum number of iterations for characteristic admittance step-response fitting.
18	NIEIG	30.	Maximum number of iterations for the eigenvalue/vector calculation.

The "TOLERANCES" data card is characterized by this key-word text which is to be punched in columns 1-10. By means of one or more such data cards, the user can re-define as many of the above-tabulated parameters as he may desire. Note that there are five fields on each such data card, each with space for a 2-digit integer ("Index"; I2 format) and a floating-point number ("value"; E11.0 format). There are no restrictions as to ordering of the parameters which are to be altered, and not all fields need be filled (any blank fields are ignored).

As an example, suppose that the user wanted to allow as many as sixty iterations for the eigenvalue/vector calculation. He could punch "18" in columns 39-40 and "60." in columns 49-51 ---- which would correspond to the use of the third field on the data card.

3) Miscellaneous data card (Point S4 data)

The miscellaneous data card is the one mandatory card for each data case within "SEMLYEN SETUP". The format and meaning of parameters which are to be punched thereupon are as follows:

TEXT	NOO	NPPOINT	NSS	KFIT	KPS	KYC	IPUN	IDPC	IPTX	IØSS	IØFL	RHØ	DIST	NPAN
A8	I5	I5	I2	I2	I2	I2	I2	I2	I6	I6	I6	E12.5	E12.5	I3

TEXT (1-8) ----- Eight characters of alphanumeric text, for which the following choices are possible:

- a) If left blank, then the EMTP will expect a full "LINE CONSTANTS" or "CABLE CONSTANTS" data case to follow. Such a choice is mandatory for the first data case within "SEMLYEN SETUP" usage.
- b) If punched with "NEW RHO", then physical data for "LINE CONSTANTS" or "CABLE CONSTANTS" is assumed to be the same as was used for the preceding data case within "SEMLYEN SETUP"; only the homogeneous earth resistivity "RHO" is to be different, as punched in the field of columns 49-60. In this case, Point S6 data is to be omitted (no "LINE CONSTANTS" or "CABLE CONSTANTS" data case is to follow).
- c) If punched with "OLD DATA", then line constants or cable constants of the preceding data case are to be re-used; only the transmission circuit length "DIST" (as punched in columns 61-72) is to be different.

NOO (9-13) ----- The number of points per travel time at the speed of light, for the propagation step response as found by inverse Fourier transformation (f_1 sequence).

This defines the basic time-axis spacing Δt which is to be used. See parameter "KFIT" below, also.

NPOINT (14-18) ----- number of time points for which the inverse fourier routine will calculate the response for fitting purposes.

NSS (19-20) ----- Flag which is used to indicate whether or not the transmission circuit phases are assumed to all be continuously transposed:

$$\left\{ \begin{array}{l} 0 \Rightarrow \text{Untransposed circuit} \\ 1 \Rightarrow \text{Continuously-transposed circuit} \end{array} \right.$$

The untransposed circuit requires the iterative calculation of eigenvalues, while the continuously-transposed one does not, recall.

KFIT (21-22) ----- There are several options controlled by two independent digits which are decoded from the field of width Two:

N1 (21) --- Digit which indicates how the characteristic admittance is to be fit. Leave blank or zero, for frequency-domain fitting (which is the usual case). A value of "1" will produce time-domain fitting, in theory.

N2-- (22) Digit which indicates the desired basis of the time-axis spacing Δt used for fitting of the propagations step response. A value of 0 will use $\Delta t = \text{travel time}/\text{NOO}$ above.

A value of 1 will locate the $2/3$ point of the propagation step response and size the Δt to put approximately 15% of NPOINT values between the toe and the $2/3$ point.

A value of 2 will locate the $2/3$ point and the $1/3$ point of the propagation step response and size the time step to put approximately 5% of NPOINT values between the $1/3$ and $2/3$ points. Because of oscillations in the output of inverse fourier routines, one or both of these points may not be obtainable, requiring either a reduction in the value of N2, or an increase in the number of frequency points so as to increase the accuracy of the inverse fourier routine.

KPS (23-24) ----- A flag which indicates whether or not fitting at the steady-state frequency is desired:

$$\left\{ \begin{array}{l} 0 \text{ --- No fitting at the steady-state frequency} \\ 1 \text{ --- Attempt to fit the propagation step-response exactly at the steady-state frequency.} \end{array} \right.$$

- 2 ----- The same as for KPS = 1 , except that if the iteration does not converge, the original (starting) fitting shall be reverted to.

KYC
(25-26)

----- A parameter which indicates how the characteristic admittance is to be treated:

- 0 ⇒ For all modes, use fitted time-dependent characteristic admittance modeling;
- 1 ⇒ For all modes, use constant characteristic admittance modeling (at the steady-state frequency);
- 2 ⇒ Only the earth-return (zero-sequence) mode is to be treated as if KYC = 0 ; all line modes (if any) are to be treated as if KYC = 1 ;
- 3 ⇒ Like for KYC = 1 (constant characteristic admittance), only use the natural resonant frequency of the line in place of the steady-state frequency. This frequency is $0.5 / \text{TAU}$, where "TAU" is the travel time of the line at the speed of light. Actually, the closest known frequency point to this resonant frequency will be used, for convenience.

Note that these options only use column 26 , really. Column 25 (the first of two possible digits) is used as an extra, independent flag, to be added after the above choice for column 26 has already been made. If column 25 is punched with "1" , there will be a printer plot of characteristic admittance vs. time, showing how the frequency-domain-fitted exponentials compare with an independent inverse Fourier transformation result.

IPUN
(27-28)

----- Parameter which indicates whether or not the EMTP branch cards which are to be constructed are to be punched:

- 0 ----- Branch cards are to be outputted on both the line printer and the punch (LUNIT7);
- 1 ----- Punch only;
- 2 ----- Printer only.

Punched cards will appear on logical unit number "LUNIT7" , which is assigned within module "SYSDEP" of overlay number 1 if not equal to seven. Whether such output goes automatically to the punch, or to a disk file, will depend on the program setup (see Program Maintenance if there are questions).

- IDOC (29-30) ----- Flag which indicates whether the branch cards that are to be outputted are to be preceded by descriptive comment cards. For this purpose, the data cards of "LINE CONSTANTS" or "CABLE CONSTANTS" are used, after conversion to comment cards ("C" in column number 1).
- $\left\{ \begin{array}{l} 0 \Rightarrow \text{no such comment cards will be outputted;} \\ 1 \Rightarrow \text{yes, append these comment cards.} \end{array} \right.$
- IOTX (31-36) ----- Parameter which controls the printout of intermediate results (e.g., eigenvalues and eigenvectors) which are computed at the frequency of the diagonalizing transformation (generally 5000 Hz or thereabouts).
- $\left\{ \begin{array}{l} -1 \Rightarrow \text{User is confused by octal numbers, and would prefer to punch "IOTX", "IOSS", and "IOFL" in binary. In this case, "IOSS" and "IOFL" fields (columns 37-48) are to be left blank, and three extra cards (Point S5 data) are to follow as extensions to the miscellaneous data card.} \\ 0 \Rightarrow \text{No such intermediate printout is desired.} \\ K \Rightarrow \text{Positive octal "K" will control the printout in question (at the transformation frequency) - as documented in the explanation of Point S5 data.} \end{array} \right.$
- IOSS (37-42) ----- Like "IOTX" above, only for the steady-state frequency (rather than for the transformation frequency). This field is ignored, if "IOTX" is equal to -1 .
- IOFL (43-48) ----- Like "IOTX" above, only for ten discrete frequencies within the loop over geometrically-spaced frequencies. This field is ignored, if "IOTX" is equal to -1 .
- RHO (49-60) ----- Resistivity of the homogeneous earth, in units of Ohm-meters . This data field is ignored unless "TEXT" of columns 1-8 is equal to either "NEW RHO " or "OLD DATA" .
- DIST (61-72) ----- Length of the transmission circuit, in units of miles . This data field is ignored unless "TEXT" of columns 1-8 is equal to either "NEW RHO " or "OLD DATA" .

NPAN
(73-75)

----- A special flag which is to be punched nonzero only if the user wants to experiment with an alternate inverse Fourier transformation which is based on the trapezoidal rule.

$\left\{ \begin{array}{l} 0 \Rightarrow \text{No such trapezoidal-rule algorithm is desired;} \\ N \Rightarrow \text{For positive "N", the trapezoidal rule} \\ \text{will be used. "N" is the number of} \\ \text{integration panels per cycle of the integrand,} \\ \text{or per interval between successive line (cable)} \\ \text{constants points --- which ever is the smaller.} \end{array} \right.$

4) Extensions to miscellaneous data card (Point S5 data)

If and only if field "IOTX" of columns 31-36 of the miscellaneous data card is punched with the value -1, three extra cards are to immediately follow the miscellaneous data card as extensions to it. These three cards serve to define "IOTX", "IOSS", and "IOFL" ----- one variable per card, in this order. Binary is used, with up to twelve of the I4 fields of the following format being punched:

IOTX Components (binary)											
1	2	3	4	5	6	7	8	9	10	11	12
I4	I4	I4	I4	I4	I4	I4	I4	I4	I4	I4	I4

Each of these component fields is to be assigned a binary digit (either zero or one). If zero (or blank), then the associated intermediate printout will not be generated; if unity, it will be. The following is a directory showing what printout is controlled by each bit:

Index number	Column number	Description of the printout which is being controlled by this component field
1	4	Approximate modal equivalent-Pi
2	8	Approximate modal equivalent-Pi
3	12	Approximate modal characteristic Z
4	16	Approximate modal Z, Y matrices
5	20	Approximate modal velocity and attenuation
6	24	Phase-coordinate equivalent-Pi matrices
7	28	Modal equivalent-Pi matrices
8	32	Modal characteristic impedance

9	36	Exact modal Z and Y matrices
10	40	Exact modal velocity and attenuation
11	44	Exact transformation matrices
12	48	Matrices Z and Y in phase coordinates

The relation between such binary specifications and the possible octal specifications of the miscellaneous data card is simple : separate the binary bits into groups of three, and then read as an octal number. For example,

$$1\ 0\ 1\ 0\ 0\ 1\ 1\ 1\ 0\ 1\ 0\ 0\ (\text{binary}) = 101\ 001\ 110\ 100 = 5164\ (\text{octal}) .$$

7.5-C Interpretation of input data cards

As with all EMTP data cards, an 80-column card-image listing is printed on the right of the page (as the card is read, within "CIMAGE"), and interpretation is provided in columns 1-50 (to the left of the column-51 separator character "1"). For the different data classes of Section 7.5-B , interpretations shall now be documented.

First, there is the "BRANCH" card (Point S3-a data, bearing this key word beginning in column 1), which is interpreted as follows:

1	2	3	4	5	6	7	8	9	10	11	12	13	14	15	16	17	18	19	20	21	22	23	24	25	26	27	28	29	30	31	32	33	34	35	36	37	38	39	40	41	42	43	44	45	46	47	48	49	50	51
BUS NAMES FOR EACH PHASE.																																																		1

The "TOLERANCES" card (Point S3-b data, bearing this key word beginning in column 1) has interpretation which displays the five integer values (fields "Index") which are read from the card. These are in order, from left to right (e.g., the first integer is read from columns 13-14 and printed in columns 24-27 , etc.) :

1	2	3	4	5	6	7	8	9	10	11	12	13	14	15	16	17	18	19	20	21	22	23	24	25	26	27	28	29	30	31	32	33	34	35	36	37	38	39	40	41	42	43	44	45	46	47	48	49	50	51											
NEW SEMLYEN TOLERANCES.												I4	I4	I4	I4	I4																																													
												five "Index" figures																																																	

Interpretation of the miscellaneous data card (Point S4 data) displays the first seven integer parameters which were read from the card, in order:

1	2	3	4	5	6	7	8	9	10	11	12	13	14	15	16	17	18	19	20	21	22	23	24	25	26	27	28	29	30	31	32	33	34	35	36	37	38	39	40	41	42	43	44	45	46	47	48	49	50	51							
MISC. DATA.												I5					I5					I5					I5					I5					I5					1															
												N00					NP0INT					N55					KFIT					KPS					KYC					IPUN					1										
																																										1															
																																															1										
																																																				1					
																																																									1

Finally, there are the three extensions to the miscellaneous data card (Point S5 data). Recall that such cards are used if the user wants to specify parameters "IOTX", "IOSS", and "IOFL" in binary rather than in octal ---- indicated by punching -1 in the "IOTX" field of columns 31-36 as a special flag. Well, interpretation of each of the three extension cards displays the resultant octal value, as internally constructed by the EMTP (from the user's 12I4 binary input digits). Note that an I5 field is used for convenience, although the result will never involve the digits "8" or "9", and the printed number will never exceed 7777. The "??" of "IO??" is merely a symbolic reference; "TX" will be used for the first extension card, "SS" for the second, and "FL" for the third:

1	2	3	4	5	6	7	8	9	10	11	12	13	14	15	16	17	18	19	20	21	22	23	24	25	26	27	28	29	30	31	32	33	34	35	36	37	38	39	40	41	42	43	44	45	46	47	48	49	50	51
!IO??!												COMPONENTS.										OCTAL VALUE =										I5					1													
																																					1													
																																IO??					1													
																																					1													

CALCULATION OF TRANSFORMATION MATRICES. CONTINUOUS TRANSPOSITION FLAG = -0

FREQUENCY = .5300E+04

IMPEDANCE MATRIX (OHM/MILE)			ADMITTANCE MATRIX (MHO/MILE)		
.37503E+01			.0	.0	.0
.50033E+02			.41970E-03	-.69108E-04	-.27198E-04
.29970E+01	.36736E+01			.0	.0
.21313E+02	.77950E+02			.43911E-03	-.69106E-04
.29933E+01	.29970E+01	.37503E+01			.0
.10357E+02	.21313E+02	.00663E+02			.41970E-03

THE FOLLOWING VALUES ARE COMPUTED ON THE BASIS OF EXACT DIAGONALIZATION OF ZY MTX.

MODE TO PHASE VOLTAGE TRANSFORMATION MATRIX			MODE TO PHASE CURRENT TRANSFORMATION MATRIX			
1.00000	1.00000	-.42339	*	.35704	.50000	-.33768
.00000	-.00000	.00923	*	.00354	-.00000	.00099
.00000	.00000	.00000	*	.30240	-.00000	.71407
-.01214	.00000	.00000	*	-.00360	-.00000	.00707
1.00000	-1.00000	-.42339	*	.35704	-.50000	-.33768
-.00000	-.00000	.00923	*	.00354	.00000	.00099

MODE	ALPHA (NEPER/MI)	BETA (RADIANS/MI)	ATTENUATION (DB/MI)	VELOCITY (MILE/SEC)
1	.79053E-02	.19403E+00	.68664E-01	.16186E+06
2	.99420E-03	.17021E+00	.36355E-02	.18457E+06
3	.10691E-02	.16965E+00	.92857E-02	.18512E+06

Then will come output for the steady-state frequency (60 Hz):

FREQUENCY = .6000E+02

IMPEDANCE MATRIX (OHM/MILE)			ADMITTANCE MATRIX (MHO/MILE)		
.39735E+00			.0	.0	.0
.14722E+01			.50364E-05	-.32929E-06	-.32678E-06
.30993E+00	.40001E+00			.0	.0
.75538E+00	.14633E+01			.52693E-05	-.62979E-06
.24462E+00	.21900E+00	.79795E+00			.0
.67233E+00	.75536E+00	.14722E+01			.50364E-05

THE FOLLOWING VALUES ARE COMPUTED ON THE BASIS OF EXACT DIAGONALIZATION OF ZY MTX.

MODE TO PHASE VOLTAGE TRANSFORMATION MATRIX			MODE TO PHASE CURRENT TRANSFORMATION MATRIX			
1.00000	-.47718	-1.00000	*	.33681	-.34198	-.50000
.00000	-.00266	.00000	*	-.00098	-.00015	-.00000
1.01534	1.00000	.00000	*	.32145	.67343	-.00000
.00000	.01000	.00000	*	.10086	-.00196	-.00000
1.00000	-.47718	1.00000	*	.33681	-.34198	.50000
-.00000	-.00266	.00000	*	-.00098	-.00015	.00000

MODE	ALPHA (NEPER/MI)	BETA (RADIANS/MI)	ATTENUATION (DB/MI)	VELOCITY (MILE/SEC)
1	.46063E-03	.33115E-02	.40027E-02	.12155E+06
2	.24677E-03	.20112E-02	.24303E-02	.9114E+06
3	.24600E-03	.20853E-02	.21593E-02	.0079E+06

MODE	DISTRIBUTED SERIES IMPEDANCE (OHM/MILE)		DISTRIBUTED SHUNT ADMITTANCE (MHO/MILE)		CHARACTERISTIC IMPEDANCE (OHMS)		EQUIVALENT PI SERIES IMPEDANCE (OHMS)		HALF EQUIV PI SHUNT ADMITTANCE (MHO)	
	REAL	IMAG	REAL	IMAG	REAL	IMAG	REAL	IMAG	REAL	IMAG
1	.27160E+00	.36402E+00	.0	.11484E-04	.29264E+03	-.40447E+02	.50641E+01	.17993E+02	.96964E+08	.10712E-03
2	.13432E+00	.47172E+00	.0	.45972E-05	.23122E+03	-.32294E+02	.25051E+01	.87967E+01	.25412E+08	.83929E-04
3	.98664E-01	.30965E+00	.0	.10726E-04	.19442E+03	-.31312E+02	.10313E+01	.74515E+01	.30065E+08	.10003E-03

PI EQUIVALENT SERIES
IMPEDANCE MATRIX(OHMS)

HALF PI EQUIV SHUNT
ADMITTANCE MATRIX(MHMS)

.7436E+01			.21959E-08	.31258E-09	.69266E-09
.27438E+02			.46973E-04	-.77317E-05	-.30415E-05
.39464E+01	.77257E+01			.23368E-03	.37258E-09
.14051E+02	.27336E+02			.49114E-04	-.77317E-05
.36326E+01	.39464E+01	.74364E+01			.21959E-08
.12534E+02	.14061E+02	.27438E+02			.46973E-04

THE FOLLOWING VALUES ARE COMPUTED BY USE OF CONSTANT TRANSFORMATION MATRICES.

MODE	ALPHA (NEPER/MI)	BETA (RADIANS/MI)	ATTENUATION (DB/MI)	VELOCITY (MILE/SEC)
1	.46077E-03	.33596E-02	.40122E-01	.11221E+05
2	.24860E-03	.29553E-02	.21593E-01	.18279E+06
3	.26689E-03	.22842E-02	.24913E-01	.10038E+05

MODE	DISTRIBUTED SERIES IMPEDANCE(OHM/MILE)		DISTRIBUTED SHUNT ADMITTANCE(MH/MILE)		CHARACTERISTIC IMPEDANCE(OHMS)		EQUIVALENT PI SERIES IMPEDANCE(OHMS)		HALF EQUIV PI SHUNT ADMITTANCE(MHMS)	
	REAL	IMAG	REAL	IMAG	REAL	IMAG	REAL	IMAG	REAL	IMAG
1	.28157E+00	.10072E+01	.0	.10996E-04	.30554E+07	-.41805E+02	.52445E+01	.18773E+02	.92064E-08	.10257E-03
2	.96664E-01	.39965E+00	.0	.10726E-04	.19442E+07	-.23178E+02	.18019E+01	.74518E+01	.30065E-08	.10002E-03
3	.14331E+03	.56933E+00	.0	.83625E-05	.24924E+03	-.34307E+02	.26658E+01	.95024E+01	.27038E-08	.77990E-04

PI EQUIVALENT SERIES
IMPEDANCE MATRIX(OHMS)

HALF PI EQUIV SHUNT
ADMITTANCE MATRIX(MHMS)

.75243E+01			.22338E-08	.34223E-09	.73052E-09
.27929E+02			.46975E-04	-.77313E-05	-.30394E-05
.36310E+01	.73560E+01			.22207E-08	.34222E-09
.13733E+02	.26292E+02			.43146E-04	-.77319E-05
.39235E+01	.38310E+01	.75243E+01			.22338E-08
.13725E+02	.13730E+02	.27929E+02			.46975E-04

Finally will come similar outputs for ten representative frequencies within the looping over logarithmically-spaced frequencies. The first of the ten appears as follows:

NO. FREQ = 55 FIRST FREQUENCY = 50.00000 LAST FREQUENCY = 630000.0 GEO. RATIO = 1.116
TRAVEL TIME = .10012E-03 APPROX. NO. TIME STEPS PER TRAVEL TIME = 60

FREQUENCY = .1297E+03

IMPEDANCE MATRIX
(OHM/MILE)

ADMITTANCE MATRIX
(MH/MILE)

.74291E+00			.0	.0	.0
.26309E+01			.10851E-04	-.17867E-03	-.70316E-06
.56335E+00	.77743E+00			.0	.0
.13376E+01	.26657E+01			.11352E-04	-.17967E-05
.54434E+00	.56335E+00	.74291E+00			.0
.11666E+01	.13376E+01	.26309E+01			.10851E-04

THE FOLLOWING VALUES ARE COMPUTED ON THE BASIS OF EXACT DIAGONALIZATION OF ZY MTX.

MODE TO PHASE VOLTAGE
TRANSFORMATION MATRIX

MODE TO PHASE CURRENT
TRANSFORMATION MATRIX

1.00000	-.47735	-1.00000	*	.33675	-.34199	-.50000
.00000	.00396	.00000	*	.00146	.00022	-.00000
1.31555	1.00000	.00000	*	.32151	.67350	-.00000
-.00505	.00000	.00000	*	-.00127	.00292	-.00000
1.00000	-.47735	1.00000	*	.33675	-.34199	.50000
-.00000	.00396	.00000	*	.00146	.00022	.00000

MODE	ALPHA (NEPER/MI)	BETA (RADIANS/MI)	ATTENUATION (DB/MI)	VELOCITY (MILE/SEC)
1	.11230E-02	.67612E-02	.97974E-02	.12013E+06
2	.29381E-03	.44501E-02	.25920E-02	.18251E+06
3	.25614E-03	.44670E-02	.22243E-02	.18137E+06

MODE	DISTRIBUTED SERIES IMPEDANCE (OHM/MILE)		DISTRIBUTED SHUNT ADMITTANCE (MMHO/MILE)		CHARACTERISTIC IMPEDANCE (OHMS)		EQUIVALENT PI SERIES IMPEDANCE (OHMS)		HALF EQUIV PI SHUNT ADMITTANCE (MMHO)	
	REAL	IMAG	REAL	IMAG	REAL	IMAG	REAL	IMAG	REAL	IMAG
1	.61055E+00	.17910E+01	.0	.24745E-04	.27331E+03	-.45139E+02				
2	.12936E+00	.10177E+01	.0	.19388E-04	.22956E+03	-.14533E+02				
3	.99331E-01	.26070E+00	.0	.25108E-04	.19331E+03	-.11085E+02				

THE FOLLOWING VALUES ARE COMPUTED BY USE OF CONSTANT TRANSFORMATION MATRICES.

MODE	ALPHA (NEPER/MI)	BETA (RADIAN/MI)	ATTENUATION (DB/MI)	VELOCITY (MILF/SEC)
1	.11264E-02	.67500E-02	.97637E-02	.12018E+06
2	.25614E-03	.44670E-02	.22243E-02	.18182E+06
3	.25675E-03	.44543E-02	.25775E-02	.18231E+06

MODE	DISTRIBUTED SERIES IMPEDANCE (OHM/MILE)		DISTRIBUTED SHUNT ADMITTANCE (MMHO/MILE)		CHARACTERISTIC IMPEDANCE (OHMS)		EQUIVALENT PI SERIES IMPEDANCE (OHMS)		HALF EQUIV PI SHUNT ADMITTANCE (MMHO)	
	REAL	IMAG	REAL	IMAG	REAL	IMAG	REAL	IMAG	REAL	IMAG
1	.64267E+00	.18744E+01	.0	.23689E-04	.28528E+03	-.47549E+02				
2	.99031E-01	.26070E+00	.0	.23108E-04	.19331E+03	-.11085E+02				
3	.14676E+00	.15677E+01	.0	.18016E-04	.24727E+03	-.16471E+02				

Next will come output which shows how the exponentials are fitted to the propagation step responses, for each of the three modes. The first of such outputs will be for mode number one, which is the zero-sequence mode. Note that the printer plot shows graphically the approximation which is involved in use of the exponentials. Symbols on the plot are "O" for the exact curve (result of inverse Fourier transformation), "." for the exponential locus, and "*" is used whenever the preceding two lie one on top of the other.

FITTING OF THE PROPAGATION STEP RESPONSE FOR MODE 1

NO. ITER.	AMPL.	X(1)	X(2)	X(3)	ERRCR
1	.90144E+00	.10682E+02	.39621E+00	.68142E-01	.78008E-01
1	.89403E+00	.11750E+02	.39621E+00	.68142E-01	.13818E-01
1	.89706E+00	.12818E+02	.39621E+00	.68142E-01	.46169E-02
1	.88204E+00	.13886E+02	.39621E+00	.68142E-01	.59655E-02
1	.87746E+00	.14954E+02	.39621E+00	.68142E-01	.14784E-01
1	.87311E+00	.16022E+02	.39621E+00	.68142E-01	.28996E-01
1	.87021E+00	.17090E+02	.39621E+00	.68142E-01	.46742E-01
1	.86700E+00	.18159E+02	.39621E+00	.68142E-01	.67189E-01
1	.86411E+00	.19227E+02	.39621E+00	.68142E-01	.89407E-01
1	.86150E+00	.20295E+02	.39621E+00	.68142E-01	.11276E+00
1	.86780E+00	.12819E+02	.39621E+00	.68142E-01	.46169E-02

ITERATIONS TO ADJUST FITTING AT 60HZ

	AMPL 1	AMPL 2	TIME CONST	ERRCR AT 60HZ
1	.99291E+00	.11709E+00	.50116E-03	.31117E-01
2	.99703E+00	.13217E+00	.52678E-03	.39388E-01
3	.90255E+00	.07449E-01	.55413E-03	.39335E-01
4	.93736E+00	.92939E-01	.58322E-03	.39283E-01
5	.91129E+00	.88652E-01	.61466E-03	.39231E-01
6	.91540E+00	.84501E-01	.64661E-03	.39180E-01
7	.91920E+00	.80798E-01	.68075E-03	.39131E-01
8	.92275E+00	.77252E-01	.71629E-03	.39083E-01
9	.92603E+00	.73972E-01	.75299E-03	.39037E-01

60HZ FITTING TOLERANCE NOT ACHIEVED. ERROR = .339936E-01

WARNING---PROGRAM CAN NOT ADJUST PROPAGATION STEP RESPONSE TO FIT EXACTLY AT STEADY STATE FREQUENCY. INITIAL FITTING ASSUMED.

FIRST AMPLITUDE	=	.887805E+00
FIRST TIME CONSTANT	=	.781368E-05
SECOND AMPLITUDE	=	.112195E+00
SECOND TIME CONSTANT	=	.252644E-03
DELAY	=	.106938E-03

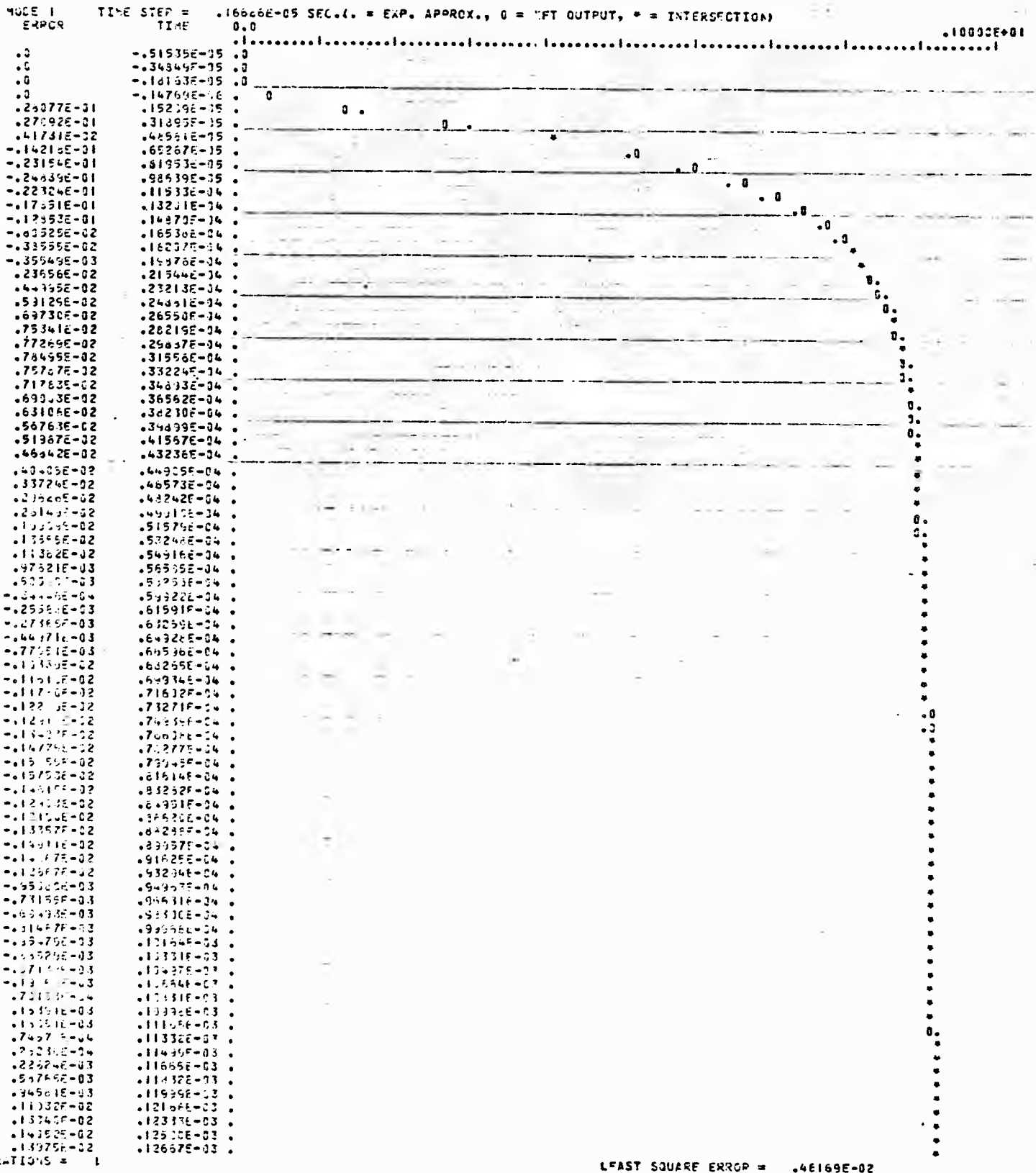

Finally, the printout will end with information about the admittance fitting, and a listing of the EMTF branch cards which are to be punched. This is shown on the following page:

7.7 "CABLE CONSTANTS" Supporting Routine

7.7.1 Introduction and Background

By means of the special request word "CABLE CONSTANTS", an EMTF user gains access to the supporting routine which bears this same name, as per the explanation of Section 7. . The principal function of this code is to calculate the resistance, inductance, and capacitance matrices which correspond to an arbitrary configuration of single-core (SC) coaxial cables. A pipe-type configuration (where the aforementioned SC coaxial cables are all enclosed in a conducting pipe) is also allowed. Line constants for conventional overhead transmission lines can also be calculated using "CABLE CONSTANTS"; this calculation is completely independent of the "LINE CONSTANTS" routine of Section 7.4 .

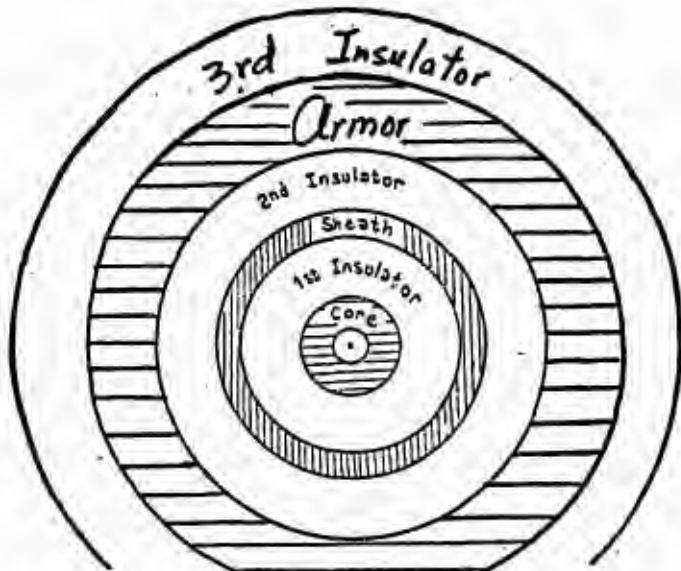

Fig. 1. Cross-section of most general SC coaxial cable geometry.

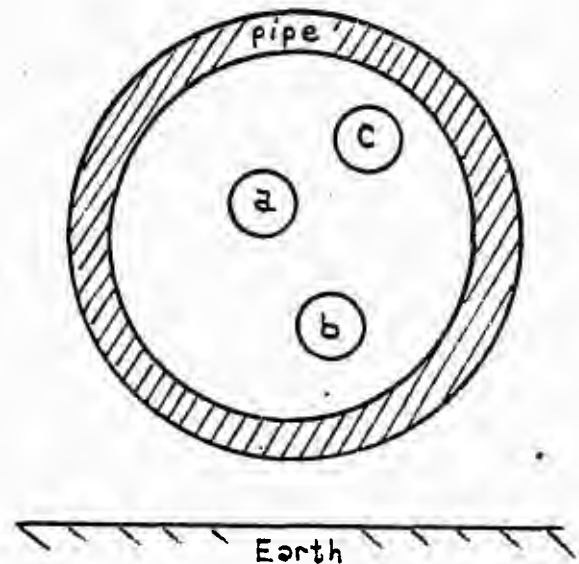

Fig. 2. Illustrative cross-section of overhead pipe-type cable system which contains three SC coaxial cables.

History of the EMTF "CABLE CONSTANTS" routine might be briefly summarized. As described in Section V-B (page MPPT-35) of the Vol. IV EMTF memorandum dated March 27, 1976 (see Reference 8), Prof. Akihiro Ametani of Doshisha University in Kyoto, Japan was retained by BPA to work on the calculation of cable constants, among other things. This work, performed in the Spring and Summer of 1976, led to what is today the EMTF "CABLE CONSTANTS" feature. Pipe-type capability was added a year later, also under contract. Aki had written and tested a separate, self-contained program, which Tsu-huei (Dr. Tsu-huei Liu of BPA) then integrated into the EMTF, making it machine translatable (sort of) and otherwise compatible. Further details of this implementation work are covered in Reference 8, Vol. VII, July 14, 1977.

There is one important restriction or limitation to the "CABLE CONSTANTS" routine, as of September, 1977:

Restriction : The code of "CABLE CONSTANTS" makes heavy use of FORTRAN COMPLEX variables. For some computers, precision might conceivably be a problem (it is not clear, as of September, 1977). For example, Univac, Honeywell, and G.E. Mark III are believed to be limited to 36 bits of floating-point precision; there is no complex double-precision arithmetic on these systems, apparently.

7.7.2 General Structure of "CABLE CONSTANTS" Data Cards.

The structure of an EMTP data case which uses "CABLE CONSTANTS" will depend upon which of the following three classes it falls into:

Class A : System of SC coaxial cables without any enclosing pipe

Class B : System of SC coaxial cables within an enclosing pipe

Class C : System of conventional overhead conductors

Class A Data Structure

Consider the case of a system of SC coaxial cables, but no conducting pipe to enclose it. An EMTP data case which uses "CABLE CONSTANTS" for this class of problem then will have input data cards ordered as follows:

- A1. First comes a "BEGIN NEW DATA CASE" card (actually optional, as per Section 1.0a).
- A2. Next comes a "CABLE CONSTANTS" card, which serves to transfer control to the overlay in question (UTPF overlay number 47).
- A3. Next comes a miscellaneous data card.
- A4. Next comes one (or possibly more) card upon which is punched the number of conductors which make up each SC coaxial cable of the system. One card will suffice for a system of up to sixteen cables; two cards are required for 17-32 cables, etc.
- A5. Next come two (or possibly three) cards of geometrical and physical data for each SC coaxial cable in the system. E.g., for three SC coaxial cables, a maximum of nine cards would be required.
- A6. Next comes one (or possibly more) card which gives the horizontal and vertical location of the centers of all SC coaxial cables in the system. A single card will handle up to four SC coaxial cables; two cards are required for 5-8 , etc.
- A7. Next comes a frequency card, which specifies a new earth resistivity and frequency (or range of frequencies) for which cable constants are to be calculated.
- A8. Only if the stratified earth modeling is being used for an overhead cable system, two additional cards are required, to give all parameters of this more complex earth model. If the earth is instead modeled as homogeneous, no such cards exist.

- A9. Repeat the data of Point A7 and Point A8 for as many different discrete frequencies or frequency ranges as may be desired. Signal the end of such data by means of a blank card.
- A10. Repeat the data of Points A3 - A9 as often as may be desired. Each such grouping is a separate, distinct, independent data case within the "CABLE CONSTANTS" routine. Signal the end of such data by means of a blank card, which serves to transfer control back to the regular EMTP solution-mode, ready to read in a new EMTP data case.
- A11. If the user wants to shut off the EMTP at this point (rather than execute a following EMTP data case), he should simply add a "BEGIN NEW DATA CASE" card at this point, followed by a blank card. This is as per Section 1.0b .

Class B Data Structure

Consider the case of a system of SC coaxial cables which are all enclosed by a conducting pipe. An EMTP data case which uses "CABLE CONSTANTS" for this class of problem will then have input data cards ordered as follows:

- B1. First comes a "BEGIN NEW DATA CASE" card (actually optional, as per Section 1.0a) .
- B2. Next comes a "CABLE CONSTANTS" card, which serves to transfer control to the overlay in question (UTPF overlay number 47).
- B3. Next comes a miscellaneous data card.
- B4. Next will come one card which gives parameters of the pipe.
- B5. Next will come one (or possibly more) card which specifies the location of each SC coaxial cable within the pipe. One card will suffice for up to 4 SC coaxial cables, two will be required for 5-8 SC coaxial cables, etc.
- B6. Next comes one (or possibly more) card upon which is punched the number of conductors which make up each SC coaxial cable of the system. One card will suffice for a system of up to sixteen cables; two cards are required for 17-32 cables, etc.
- B7. Next come two (or possibly three) cards of geometrical and physical data for each SC coaxial cable in the system. E.g., for three SC coaxial cables, a maximum of nine cards would be required.
- B8. Next comes one card which gives the horizontal and vertical location of the center of the pipe.
- B9. Next comes a frequency card, which specifies a new earth resistivity and frequency (or range of frequencies) for which cable constants are to be calculated.
- B10. Only if the stratified earth modeling is being used for an overhead cable system, two additional cards are required, to give all parameters of this more complex earth model. If the earth is instead modeled as homogeneous, no such cards exist.

- B11. Repeat the data of Point B9 and Point B10 , for as many different discrete frequencies or frequency ranges as may be desired. Signal the end of such data by means of a blank card.
- B12. Repeat the data of Points B3 - B11 as often as may be desired. Each such grouping is a separate, distinct, independent data case within the "CABLE CONSTANTS" routine. Signal the end of such data by means of a blank card, which serves to transfer control back to the regular EMTP solution mode, ready to read a new EMTP data case.
- B13. If the user wants to shut off the EMTP at this point (rather than solve a following EMTP data case), he should simply add a "BEGIN NEW DATA CASE" card at this point, followed by a blank card. This is as per Section 1.0b .

Class C Data Structure

Consider the case of a system of conventional overhead conductors, as is usually solved using the "LINE CONSTANTS" routine of Section 7.4 . An EMTP data case which uses "CABLE CONSTANTS" for this class of problem will then have input data cards ordered as follows:

- C1. First comes a "BEGIN NEW DATA CASE" card (actually optional, as per Section 1.0a) .
- C2. Next comes a "CABLE CONSTANTS" card, which serves to transfer control to the overlay in question (UTPF overlay number 47).
- C3. Next comes a miscellaneous data card.
- C4. Next come three cards for each circuit which belongs to the overhead conductor system. Parameters specified include the number of phases, the number of ground wires, the number of conductors in a bundle, geometrical data, conductor resistivity, etc. E.g., considering a system which consists of a single-circuit 500-kV transmission line and a double-circuit 230-kV transmission line all on the same right of way, nine data cards would be involved.
- C5. Next comes one (or possibly more) data card which gives the height, sag, and horizontal location for the center of each bundle of each circuit of the system. One card will suffice for 1 or 2 bundles, two cards are required for 3 or 4 bundles, etc. E.g., two coupled single circuits, each of which is supported by its own towers and has a single ground wire, would require four cards (because there are eight bundles total — four for each circuit).
- C6. Next comes a frequency card, which specifies a new earth resistivity and frequency (or range of frequencies) for which line constants are to be calculated.
- C7. Only if the 3-layer Nakagawa stratified earth model is being used, two additional cards are required, to complete the parameters of this more complex model of the earth. If the earth should instead be modeled as homogeneous, no such cards exist.

Class B : Punch a "3" , which implies a system of SC coaxial cables which are enclosed within a conducting pipe.

Class C : Punch a "1" , which implies a system of conventional overhead conductors.

ISYST (6-10) ----- For Class A and Class B cases, "ISYST" indicates whether the cable system is underground or in the air:

- | | |
|---|---|
| { | -1 ⇒ Underground (buried) cable system; |
| | 0 ⇒ Cable system is in the air, but is touching the earth's surface. See further comment elsewhere. |
| | +1 ⇒ Cable system is in the air, above the surface of the earth. |

For Class C cases, "ISYST" indicates possible transposition:

- | | |
|---|--|
| { | 0 ⇒ Untransposed overhead line; |
| | 2 ⇒ Continuously-transposed overhead line. |

NPC (11-15) ----- Class A } --- Number of SC coaxial cables which make up the system of interest.
Class B }

Class C ~ The number of transmission circuits which make up the overhead system of interest. E.g., the most common case will have just NPC = 1 circuit, which will consist of three phase-conductor bundles (for a 3-phase line) and possibly one or more ground-wire bundles.

IEARTH (16-20) ----- Flag indicating which model for the earth is to be used:

- | | |
|---|--|
| { | 0 ~ for homogeneous (Carson) earth model; |
| | 99 ~ for 3-layer stratified (Nakagawa) earth model. This is allowed only for overhead systems (miscellaneous data parameter "ISYST" equal to 0 or 1). |

KMODE (21-25) ----- Flag used to request the calculation and output of various modal quantities of interest, as further described in Section

- | | |
|---|---|
| { | 0 ⇒ No modal calculation or output; |
| | 1 ⇒ Modal quantities <u>will</u> be calculated and printed. |

IZFLAG ----- Flag which indicates the format of series-impedance
(26-30) output (inductance, or reactance, or both) in the phase domain:

$\left\{ \begin{array}{l} 0 \Rightarrow \text{Print matrices } [R] \text{ and } [L] ; \\ 1 \Rightarrow \text{print matrices } [R] \text{ and } \omega[L] ; \\ 2 \Rightarrow \text{print both of the above.} \end{array} \right.$

The diagonal elements are self-impedances of the conductors and the off-diagonal elements are the mutual impedances. For overhead lines, the order of the printout is the same as that of the phase conductors are inputted. For SC coaxial cables, the printout starts from the inner-most conductor of each cable in the order of input, then continues to the next outer layer of the conductor of each cable, etc.. For a pipe-type cable system, the last series-impedance in the printout is for the pipe.

IYFLAG ----- Flag which indicates the format of shunt-admittance
(31-35) output (capacitance, or susceptance, or both)
in the phase domain:

$\left\{ \begin{array}{l} 0 \Rightarrow \text{Print matrices } [G] \text{ and } [C] ; \\ 1 \Rightarrow \text{Print matrices } [G] \text{ and } \omega[C] ; \\ 2 \Rightarrow \text{print both of the above.} \end{array} \right.$

The order of this printout is same as that for the series-impedance.

NPP ----- Class A } Unused (leave blank).
(36-40) Class C }

Class B } $\left\{ \begin{array}{l} 1 \Rightarrow \text{pipe of finite thickness} \\ 0 \Rightarrow \text{pipe of infinite thickness.} \\ \text{Miscellaneous data parameter} \\ \text{"ISYST" must also be zero, in} \\ \text{this case.} \end{array} \right.$

NGRND --- This parameter describes the grounding conditions of the
cable system, i.e., for data in Class A and Class B

Class A $\left\{ \begin{array}{l} 0 \text{ or } 1 \text{ -- None of the conductors is grounded.} \\ 2 \text{ -- All armors, if any, are grounded.} \\ 3 \text{ -- All sheathes and armors, if any, are grounded.} \\ 4 \text{ -- See the paragraph below.} \end{array} \right.$

Class B $\left\{ \begin{array}{l} 0 \text{ -- None of the conductors is grounded.} \\ 1 \text{ -- The pipe is grounded.} \\ 2 \text{ -- All armors and pipe are grounded.} \\ 3 \text{ -- All armors and all sheathes, if any, and pipe} \\ \text{are grounded.} \\ 4 \text{ -- See the paragraph below.} \end{array} \right.$

Class C - Unused (leave blank).

257a

If the grounding conditions are different for different cables in the system, or not all the outer conductors of the cables are grounded, the user should punch a value of "4" for NGRND and add one extra data card right after the current one with the format:

2x 78I1

Input an integer code number (I1), based on the following rules, for each of the cables according to their input ordering; and enter the pipe, if any, in the very last entry:

- 0 -- None of the conductors of the cable is grounded.
 - 1 -- The core of the cable is grounded.
 - 2 -- The sheath of the cable is grounded.
 - 3 -- The armor of the cable is grounded.
 - 4 -- The sheath and the armor of the cable are grounded.
 - 5 -- The core and the sheath of the cable are grounded.
 - 6 -- The core and the armor of the cable are grounded.
 - 7 -- The core, the sheath, and the armor of the cable are grounded.
- Pipe {
- 0 -- not grounded.
 - 1 -- grounded.

Format for "A4" and "B6" data

For cable systems (either Class A or Class B), the number of conductors which make up each SC coaxial cable of the system must be indicated; the following format is used:

NCP1	NCP2	NCP3	NCP4	...	One entry for each of NPC SC coaxial cables in system.
15	15	15	15	Etc.	

- NCP_k ----- The k-th SC coaxial cable of the system has this many conductors in it:
- 3 ~ for the SC coaxial cable which has all three conductors: core, sheath and armor;
 - 2 ~ for the SC coaxial cable which has only two conductors: core and sheath;
 - 1 ~ for the situation of a core only.

For purposes of this input, it may be noted that the SC coaxial cables have been numbered between "1" and "NPC". Such numbering is arbitrary, except that the string of NCP_k must be non-increasing (that is, all 3-conductor SC coaxial cables must precede any 2-conductor cables and all 2-conductor cables must precede any core only cables). this ordering, once established, is assured to apply throughout the rest of the data case.

For each circuit of the system of conventional overhead conductors which is being studied, three data cards of the following format are to be punched.

NP	NG	KBP	KBG
15	15	15	15

ROUT _P	RIN _P	ROUT _G	RIN _G	SEP _P	SEP _G
E10.1	E10.1	E10.1	E10.1	E10.1	E10.1

S_P	μ_P	S_G	μ_G
E10.1	E10.1	E10.1	E10.1

- NP ----- The number of phase-wire bundles which belong to the circuit in question. E.g., for a 3-phase circuit, "NP" will equal three.
- NG ----- The number of ground-wire bundles which belong to the circuit in question.
- KBP ----- The number of individual physical conductors which compose each phase-wire bundle of the circuit in question. If there is no bundling of phase wires, "KBP" will equal unity.
- KBG ----- The number of individual physical conductors which compose each ground-wire bundle of the circuit in question. If there is no bundling of ground wires, "KBG" will equal unity.

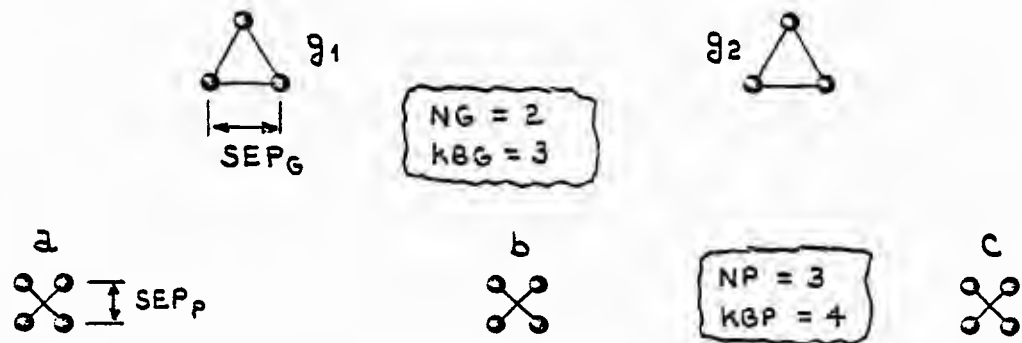

Fig. 5. Illustrative single-circuit 3-phase overhead transmission line (as seen in cross-section). The three phase-wire bundles are of four conductors each; there are two ground-wire bundles, of three conductors each.

$ROUT_P$ ----- Outer radius of the tubular conductors which are used for each phase-wire bundle of the circuit in question. Units are meters .

RIN_P ----- Inner radius of the tubular conductors which are used for each phase-wire bundle of the circuit in question. Units are meters .

$ROUT_G$ ----- Outer radius of the tubular conductors which are used for each ground-wire bundle of the circuit in question. Units are meters .

RIN_G ----- Inner radius of the tubular conductors which are used for each ground-wire bundle of the circuit in question. Units are meters .

SEP_P ----- Separation between centers of two adjacent conductors of any one of the phase-wire bundles. Units are meters .
The "KBP" conductors of the bundle are assumed to be uniformly spaced around the circumference of a circle.

SEP_G ----- Separation between centers of two adjacent conductors of any one of the ground-wire bundles. Units are meters .
The "KBG" conductors of the bundle are assumed to be uniformly spaced around the circumference of a circle.

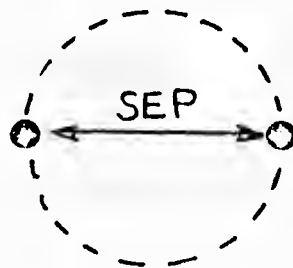
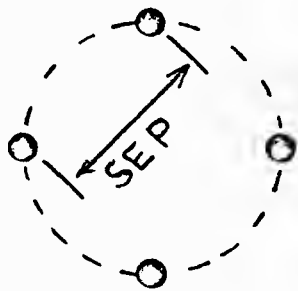
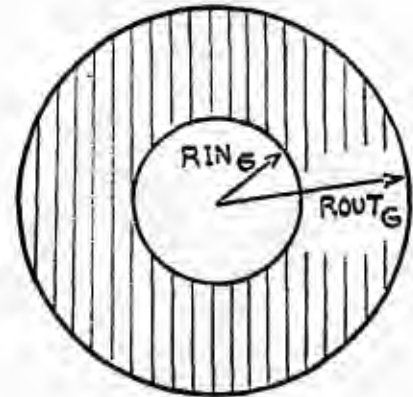
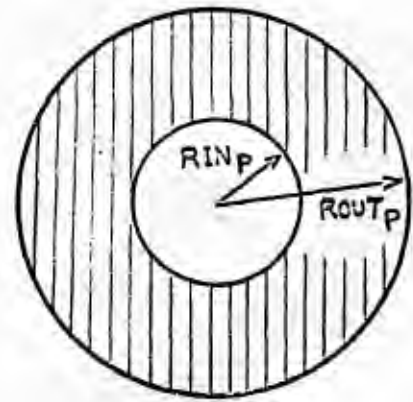

Fig. 8. Illustration of two different bundles; that on the left has four conductors, while the bundle on the right has only two. Note the uniform spacing.

ρ_P ----- Resistivity of the material used in each tubular conductor of each phase-wire bundle of the circuit under consideration. Units are ohm-meters .

μ_P ----- Relative permeability of the material used in each tubular conductor of each phase-wire bundle of the circuit under consideration. This is a dimensionless quantity.

ρ_g ----- Resistivity of the material which is used in each tubular conductor of each ground-wire bundle of the circuit under consideration. Units are ohm-meters .

μ_g ----- Relative permeability of the material which is used in each tubular conductor of each ground-wire bundle of the circuit under consideration. This is a dimensionless quantity.

Format for "A5" and "B7" data

For each SC coaxial cable of the system, a maximum of three data cards are to be punched according to the following format. Such cards are to be stacked in the circuit order which was defined for Point "A4" data.

r_1	r_2	r_3	r_4	r_5	r_6	r_7
E10.1	E10.1	E10.1	E10.1	E10.1	E10.1	E10.1

ρ_c	μ_c	μ_{I1}	ϵ_{I1}	ρ_s	μ_s	μ_{I2}	ϵ_{I2}
E10.1	E10.1	E10.1	E10.1	E10.1	E10.1	E10.1	E10.1

ρ_a	μ_a	μ_{I3}	ϵ_{I3}
E10.1	E10.1	E10.1	E10.1

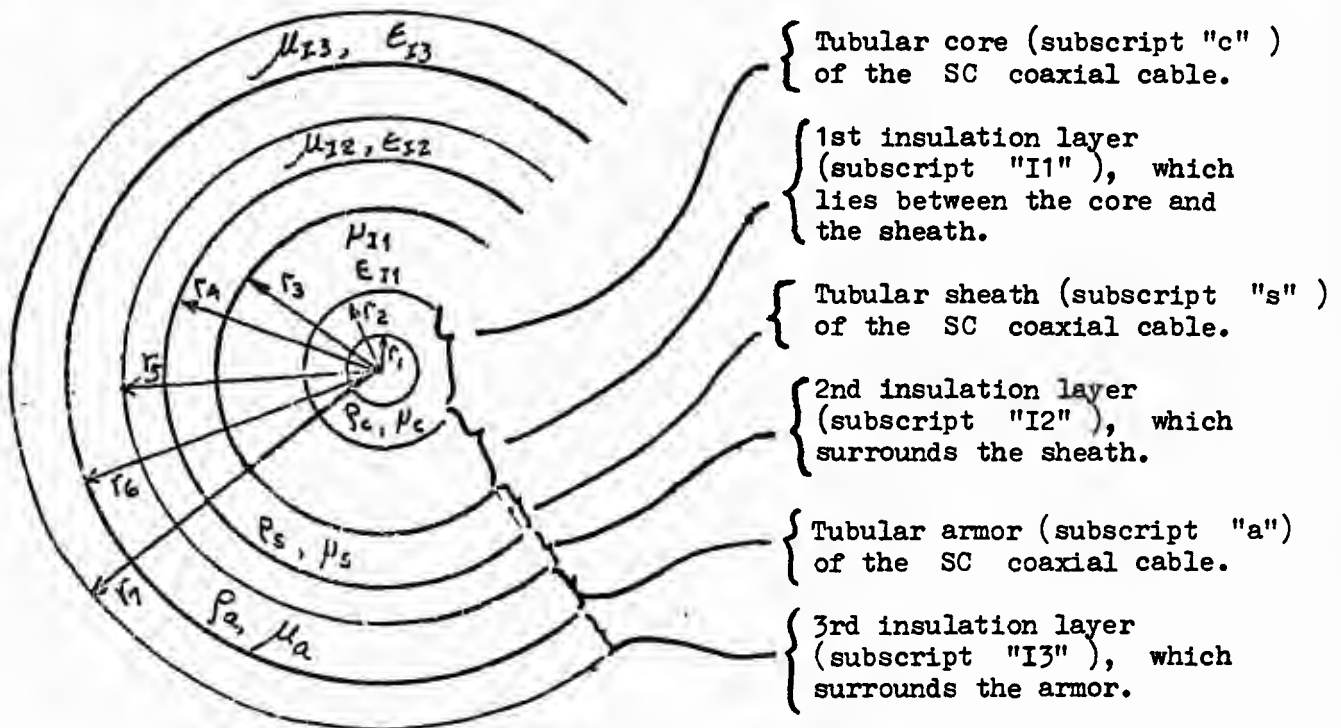

- r_1 ----- Inner radius of the tubular core, for the SC coaxial cable under consideration. Units are meters .
- r_2 ----- Outer radius of the tubular core (equal to the inner radius of the first insulating layer), for the SC coaxial cable under consideration. Units are meters .
- r_3 ----- Inner radius of the sheath (equal to the outer radius of the first insulating layer), for the SC coaxial cable under consideration. Units are meters .
- r_4 ----- Outer radius of the sheath (equal to the inner radius of the second insulating layer), for the SC coaxial cable under consideration. Units are meters .
- r_5 ----- Inner radius of the armor (equal to the outer radius of the second insulating layer), for the SC coaxial cable under consideration. Units are meters .
- r_6 ----- Outer radius of the armor (equal to the inner radius of the third insulating layer), for the SC coaxial cable under consideration. Units are meters .
- r_7 ----- Outer radius of the third (outer-most) layer of insulation, for the SC coaxial cable under consideration. Units are meters .
- ρ_c ----- Resistivity of the tubular core, for the SC coaxial cable under consideration. Units are ohm-meters .
- μ_c ----- Relative permeability of the tubular core, for the SC coaxial cable under consideration. This is a dimensionless quantity.
- μ_{I1} ----- Relative permeability of the 1st insulating layer. This is a dimensionless quantity.
- ϵ_{I1} ----- Relative permittivity of the 1st insulating layer. This is a dimensionless quantity.
- ρ_s ----- Resistivity of the tubular sheath, for the SC coaxial cable under consideration. Units are ohm-meters .
- μ_s ----- Relative permeability of the tubular sheath. This is a dimensionless quantity.
- μ_{I2} ----- Relative permeability of the 2nd insulating layer. This is a dimensionless quantity.
- ϵ_{I2} ----- Relative permittivity of the 2nd insulating layer. This is a dimensionless quantity.

- ρ_a ----- Resistivity of the tubular armor, for the SC coaxial cable under consideration. Units are ohm-meters .
- μ_a ----- Relative permeability of the tubular armor. This is a dimensionless quantity.
- μ_{I3} ----- Relative permeability of the 3rd insulating layer. This is a dimensionless quantity.
- ϵ_{I3} ----- Relative permittivity of the 3rd insulating layer. This is a dimensionless quantity.

Format for "B5" data

The location of each of the "NPC" SC coaxial cables within the surrounding conducting pipe is specified by one (or possibly more) card of the following format:

DIST ₁	THETA ₁	...	One pair of numbers for each SC coaxial cable within the pipe.
E10.1	E10.1	Etc.	

- DIST_k ----- Distance between the center of the pipe and the center of the k-th SC coaxial cable, in units of meters .
- THETA_k ----- Angular position of the k-th SC coaxial cable, in units of degrees.

Here the pair (DIST_k , THETA_k) is simply the conventional polar coordinate location of the k-th SC coaxial cable. The origin is taken to be the center of the pipe (see sketch), with the positive x-axis directed horizontally to the right.

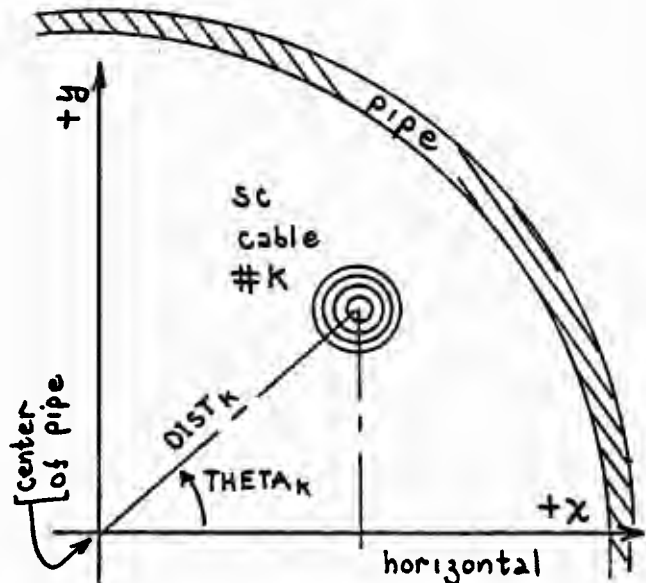

Format for "C5" data

For each bundle of the overhead conductor system, a triplet of numbers giving the horizontal and vertical location is to be supplied, according to the following format:

VTOWER ₁	VMID ₁	HORIZ ₁	...	One triplet of numbers for each bundle of the system
E10.1	E10.1	E10.1	Etc.	

VTOWER_k ----- Height above the earth's surface of the center of the k-th bundle; this is height in meters, at the tower (the maximum height).

VMID_k ----- Height above the earth's surface of the center of the k-th bundle; this is height in meters, at mid-span (the minimum height).

HORIZ_k ----- The center of the k-th bundle is this far to the right of an arbitrarily chosen reference line.

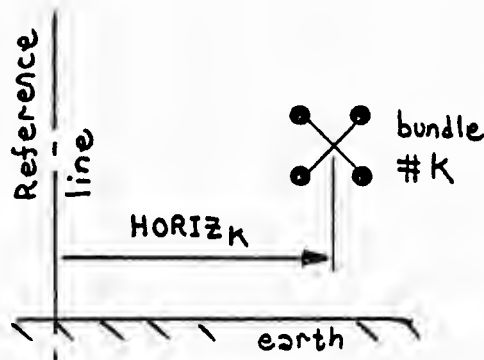
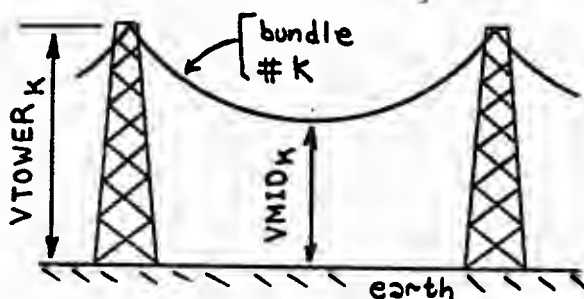

With regard to the ordering of the bundles which belong to the system under study (i.e., index "k"), two rules must be observed:

Rule 1 : First come all phase-wire bundles of the system, in order of the circuit number to which they belong (as established by Point C4 data). I.e., start with all phase-wire bundles of circuit number one; then consider all of the phase-wire bundles of circuit number two, etc.

Rule 2 : Then come all (if there are any) ground-wire bundles of the system, in order of the circuit number to which they belong (as established by Point C4 data). I.e., start with all ground-wire bundles of circuit number one, if any; then consider all of the ground-wire bundles of circuit number two, etc.

Within any one circuit, ordering of the phase-wire bundles and the ground-wire bundles is arbitrary. Rows of the resulting line constants matrices $[R]$, $[L]$, and $[C]$ will be based on this ordering, however, it might be noted. See the example of Section

Format for "A6" data

For each of the "NPC" SC coaxial cables of the system, horizontal and vertical coordinates which locate the center must be specified, as follows:

SC Cable #1		SC Cable #2		•••• Etc.
VERT ₁	HORIZ ₁	VERT ₂	HORIZ ₂	
E10.1	E10.1	E10.1	E10.1	

One entry for each of NPC SC coaxial cables in the system.

VERT_k ----- Vertical separation between the center of the k-th SC coaxial cable and the surface of the earth, in units of meters. This is always a positive number, whether the system of SC coaxial cables is below the ground or not.

HORIZ_k ----- The center of the k-th SC coaxial cable is this far (in meters) to the right of an arbitrary reference line.

Here the ordering of the SC coaxial cables (i.e., index "k") is as was established in Point A4 data.

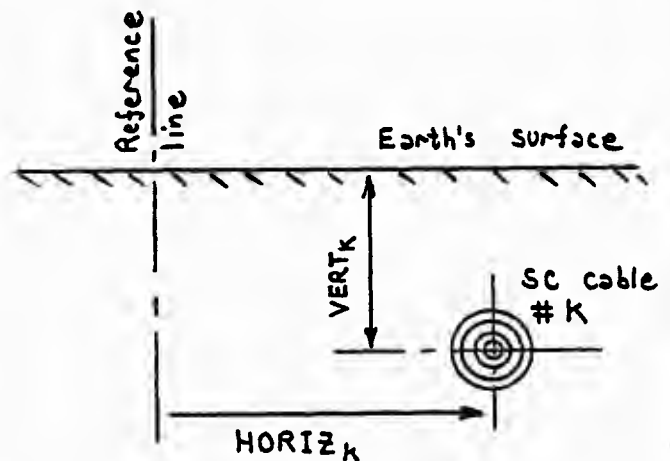
Format for "C6", "A7", and "B9" data

The "frequency card" of all three classes of data cases has the same format:

RHO	FREQ	IDEC	IPNT	DIST	IPUN
E15.6	E15.6	I5	I5	F8.3	I10

RHO ----- Resistivity of the top (i.e., surface) layer of the earth, in units of ohm-meters.

If the earth is assumed to be homogeneous (parameter "IEARTH" equal to zero; see Point A3, B3, or C3 data), "RHO" is the resistivity of the entire uniform earth.

FREQ ----- Frequency in Hertz at which cable constants (for "A7" or "B9" data) or line constants (for "C6" data) are to be calculated, should only one frequency be desired.

A blank or zero field will be defaulted to the synchronous power system frequency (generally 50 Hz or 60 Hz), as defined by variable "STATFR" of installation-dependent module "SYSDEP" of UTPF overlay number 1 .

If the automatic looping over logarithmically-spaced frequencies has been requested by the user (parameter "IDEC" of columns 31-35 greater than zero), then "FREQ" is the beginning (i.e., the lowest) frequency of the scan.

- IDEC ----- Leave blank for the normal single-frequency
(31-35) calculation. But if the user wants automatic looping over logarithmically-spaced frequencies, then "IDEC" is the number of decades of frequency space which are to be spanned.
- IPNT ----- Leave blank for the normal single-frequency
(36-40) calculation. But if the user wants automatic looping over logarithmically-spaced frequencies, then "IPNT" is the number of points per decade of frequency space at which [R], [L], and [C] are to be calculated.
- DIST ----- Length of the transmission circuit under consideration,
(41-48) in units of meters . This field can usually be left blank. It need be punched only for the following situations:
- 1) For use with "SEMLYEN SETUP" ; see Section 7.5 .
- IPUN ----- Normally this field is left blank. It is
(49-58) used to request non-printed output of modal quantities, for the case where there is automatic internal looping over logarithmically-spaced frequencies. Punch :
- "88" ----- For the connection of zero-sequence
(ground mode) impedances with "WEIGHTING" . This has meaning only when a "CABLE CONSTANTS" data case is imbedded in a "WEIGHTING" data case.
- "89" ----- As just described for "88" , only
for the line mode (rather than for the ground mode).

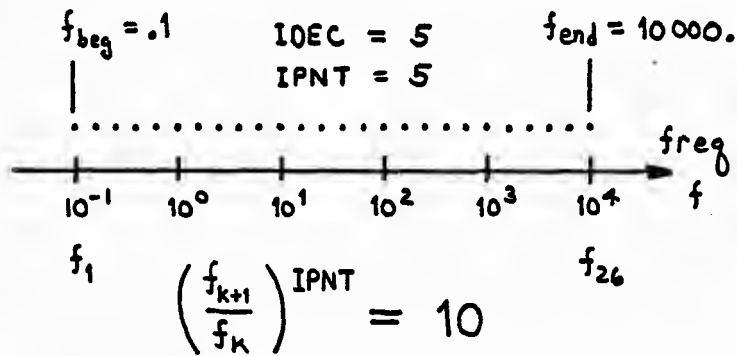

Format for "C7" , "A8" , and "B10" data

If the 3-layer stratified (Nakagawa) earth modeling is being used, then the just-described "frequency card" is to immediately be followed by two cards of the following format:

DEP ₁₂	DEP ₂₃	RHO ₂	RHO ₃
E10.1	E10.1	E10.1	E10.1

μ_1	μ_2	μ_3	ϵ_1	ϵ_2	ϵ_3
E10.1	E10.1	E10.1	E10.1	E10.1	E10.1

DEP₁₂ ----- Distance below the surface of the earth at which layer number 1 ends and layer number 2 begins. Units are meters . See sketch below.
 (1-10)

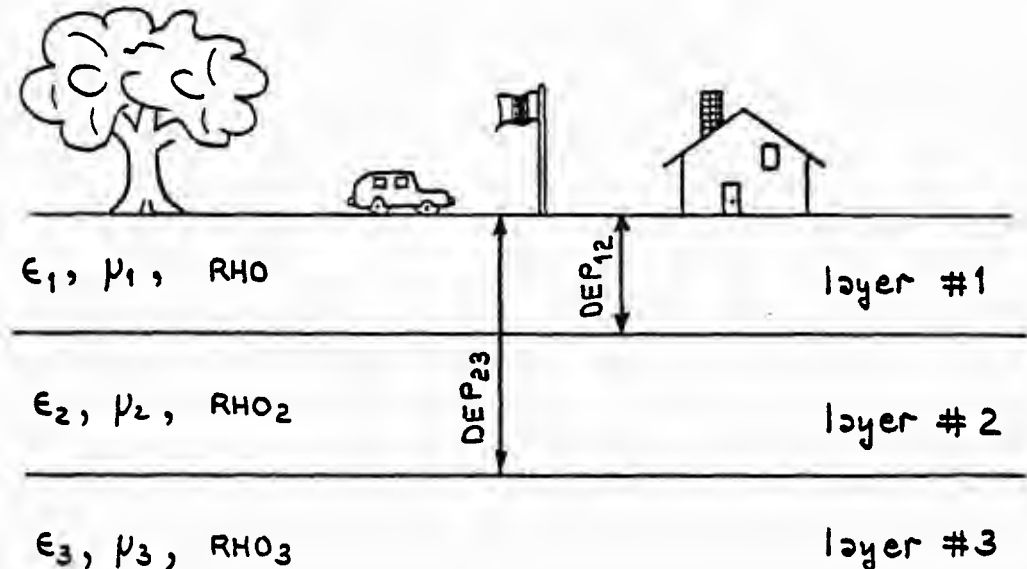

7.7.4 Degenerate Configurations and Special Cases

It is the purpose of the present section to describe how the user of "CABLE CONSTANTS" can handle special configurations which are less general than those described in Section 7.7.3 .

A) Pipe without tubular insulator around it

Suppose that a pipe-type (Class B) configuration is involved, but without any insulating tube around the outside of the conducting pipe. Then Point B4 data is to be treated as follows:

1. Leave RP_3 (columns 21-30) blank.
2. Leave the data field for ϵ_2 (columns 61-70) blank.

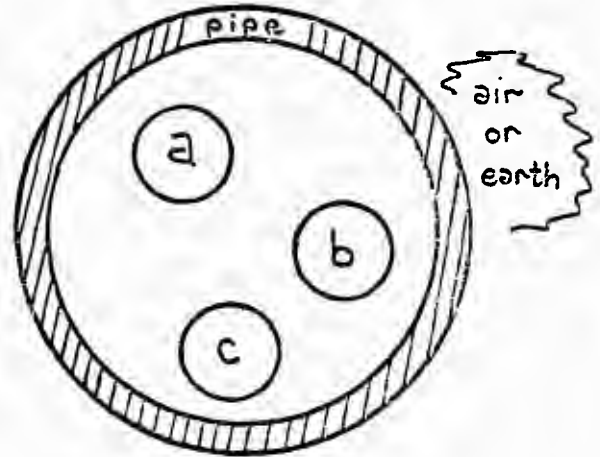
B) Infinitely-thick pipe

While physically unrealizable, a pipe of infinite thickness is nonetheless useful in certain situations as a modeling approximation. This is a special case of the Class B situation. By definition, there is no earth for this case, and all zero-sequence current of the enclosed SC coaxial cables must return through the pipe. Data requirements for this special case are as follows:

1. On the Point B3 miscellaneous data card, two parameters are to be punched unusually:
 - "ISYST" of columns 6-10 is to be punched zero;
 - "NPP" of columns 36-40 is to be punched zero (rather than the usual value of unity).
2. On the Point B4 data card, three data fields can be left blank:
 - " RP_2 " of columns 11-20 ----- since the outer radii of the pipe and the surrounding insulator are not even finite.
 - " RP_3 " of columns 21-30
 - " ϵ_2 " of columns 61-70 ----- since the surrounding insulator does not even exist (or if it does, it is infinitely far away!).
3. On the "frequency card" of Point B9 data, field RHO of columns 16-30 can be left blank ----- since the earth no longer exists.

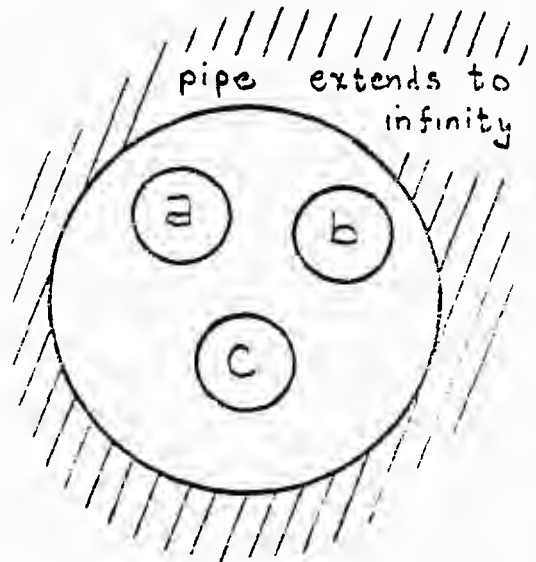

C) Solid core for SC coaxial cable

For either Class A or Class B cable systems, the core of any SC coaxial cable can be made solid rather than tubular, if so desired. The first of two Point A5 or Point B7 data cards has columns 1-10 used for punching the inner radius r_1 of the tubular core. Simply set this parameter to zero, to produce a solid core.

D) Solid overhead-line conductors

For a conventional overhead transmission line of Class C, the conductors of either the phase-wire bundles or the ground-wire bundles can be made solid, rather than tubular, if so desired. Recall that the second of three Point C4 data cards is punched with an inner radius RIN_P for phase-wire conductors, and RIN_G for ground-wire conductors.

1. Set RIN_P of columns 11-20 equal to zero, in order to obtain solid conductors for the phase wires.
2. Set RIN_G of columns 31-40 equal to zero, in order to obtain solid conductors for the ground wires.

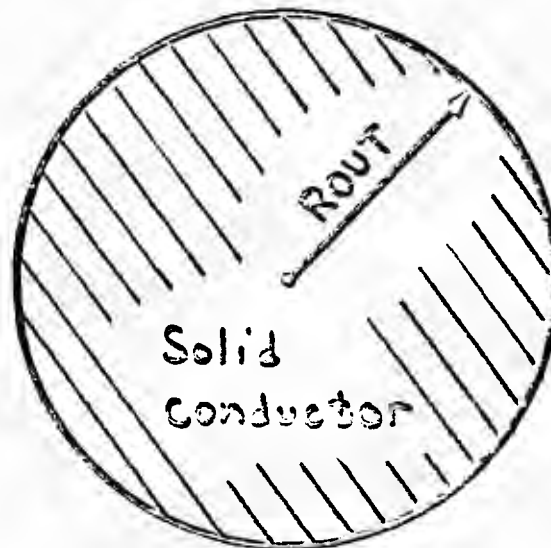
E) No bundling of conductors

For a conventional overhead transmission line of Class C, it is Point C4 data which specifies whether phase-wire or ground-wire conductors are to be bundled.

1. If a phase-wire bundle only consists of a single tubular conductor (i.e., if there is no bundling of phase conductors), then "KBP" of columns 11-15 of the first Point C4 data card will be punched equal to unity, by definition. Field SEP_P of columns 41-50 of the second Point C4 data card can then be left blank ----- since interconductor separation within a phase-wire bundle does not exist.
2. If a ground-wire bundle only consists of a single tubular conductor (i.e., if there is no bundling of ground conductors), then "KBG" of columns 16-20 of the first Point C4 data card will be punched equal to unity, by definition. Field SEP_G of columns 51-60 of the second Point C4 data card can then be left blank ----- since interconductor separation within a ground-wire bundle does not exist.

F) SC coaxial cable without outer insulator

For a Class A or Class B data case, the outer (or 3rd) layer of insulation of any SC coaxial cable can be omitted. In this case, the three Point A5 or Point B7 data cards are handled as follows:

1. Leave r_7 (columns 61-70) of the first card blank.
2. Leave data fields μ_{I3} and ϵ_{I3} (columns 31-40 of the third card) blank ---- since such parameters do not exist.

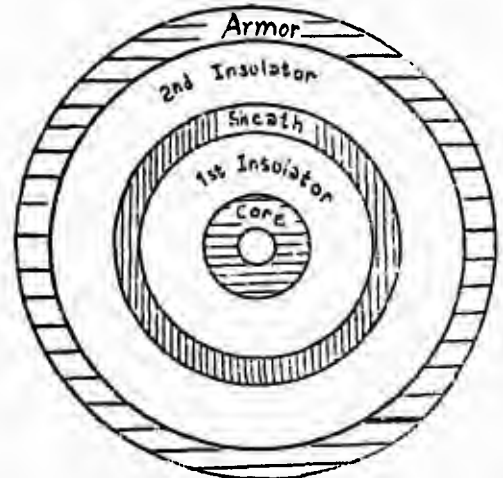
G) SC coaxial cable with no armor and no outer insulator

For a Class A or Class B data case, both the armor and the outer (or 3rd) layer of insulation of any SC coaxial cable can be omitted. In this case, the three Point A5 or Point B7 data cards are handled as follows:

1. Leave r_7 and r_6 (columns 51-70 of the first card) blank.
2. Omit the 3rd data card because of the nonexistence of ρ_a , μ_a , μ_{I3} and ϵ_{I3} .

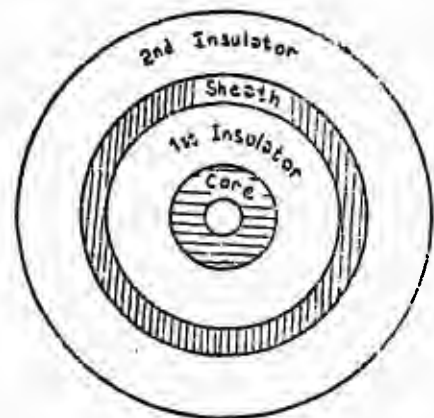
H) SC coaxial cable with no armor and no outer insulators

For a Class A or Class B data case, the outer (2nd and 3rd) layers of insulation and armor of any SC coaxial cable can be omitted. In this case, the three Point A5 or Point B7 data cards are handled as follows:

1. Leave r_7 , r_6 and r_5 (columns 41-70 of the first card) blank.
2. Leave data fields μ_{I2} and ϵ_{I2} (columns 61-80 of the second card) blank and omit the third card ---since such parameters do not exist.

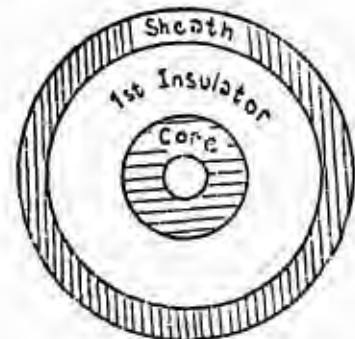

I) SC coaxial cable with not sheath and no outer insulators

For a Class A or Class B data case, both the sheath, armor and the outer (2nd and 3rd) layers of insulation of any SC coaxial cable can be omitted. In this case, the three Point A5 or Point B7 data cards are handled as follows:

1. Leave r_7 , r_6 , r_5 and r_4 (columns 31-70 of the first card) blank.
2. Leave blank all other data fields which are used for parameters of the nonexistent sheath and outer insulator. In particular, there are four: ρ_s , μ_s , μ_{I2} and ϵ_{I2} (columns 41-80 of the 2nd card).
3. Omit the third card --- since parameters for armor and its outer insulator do not exist.

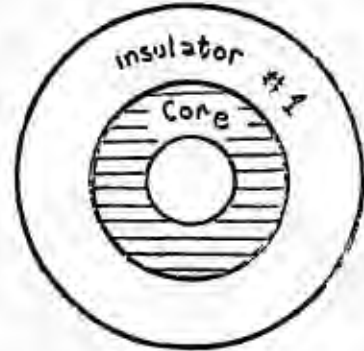
J) SC coaxial cable having core only (all three insulators, armor and sheath missing)

For a Class A or Class B data case, the armor, sheath and all three layers of insulation of any SC coaxial cable can be omitted, leaving just the tubular conductor core. In this case, the three Point A5 or Point B7 data cards are handled as follows:

1. Leave r_7 , r_6 , r_5 , r_4 and r_3 (columns 21-70 of the first card) blank.
2. Leave blank all other data fields which are used for parameters of the nonexistent sheath and layers of insulation. In particular, there are six: μ_{I1} , ϵ_{I1} , ρ_s , μ_s , μ_{I2} and ϵ_{I2} (columns 21-80 of the 2nd card).
3. Omit the third card --- since the parameters for armor and its outer insulator do not exist.



7.7.5 Approximation Used for the Bundling of Overhead Conductors

It is important for the user to be aware that treats bundled conductors of conventional overhead transmission lines quite differently than does "LINE CONSTANTS" of Section 7.4 . The reader may already have realized this, since the Point C4 data is not sufficient to uniquely specify the geometry of a bundle. No angular position of any one conductor of the bundle is specified, it will be noted.

The "LINE CONSTANTS" code of Section 7.5 calculates line constants for the system of physical conductors first. This is then reduced, as conductors are paralleled (the bundling operation). On the other hand, "CABLE CONSTANTS" does the bundling at data-input time. The geometric mean radius of the bundle is immediately calculated, and then a single approximately equivalent conductor is used to represent each bundle for the calculation of line constants. There never is any set of line constants for the system of physical conductors, then, when using "CABLE CONSTANTS" .

Needless to say, this bundling of conductors at data-input time simplifies the calculation considerably, and speeds it up. But an approximation is involved. In order to estimate the error, line constants have been calculated for the 2-phase geometry shown at the right. The "LINE CONSTANTS" code was used, for two different values of the angle α : zero degrees and 90 degrees. The radius of the bundles "r", the average height "h", the separation "D", and the frequency "f" were also varied. In all cases, a conductor diameter of 1.093 inches was used, and ground resistivity was fixed at 50 ohm-meters. Results are summarized in the following tabulation:

Sorry! Example never completed; no next page.

"CABLE CONSTANTS"

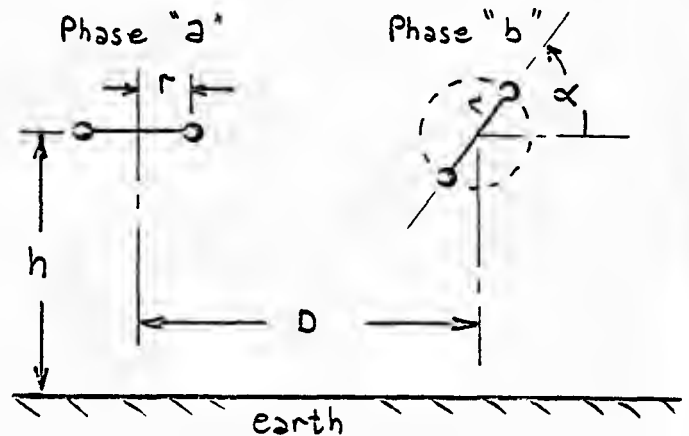
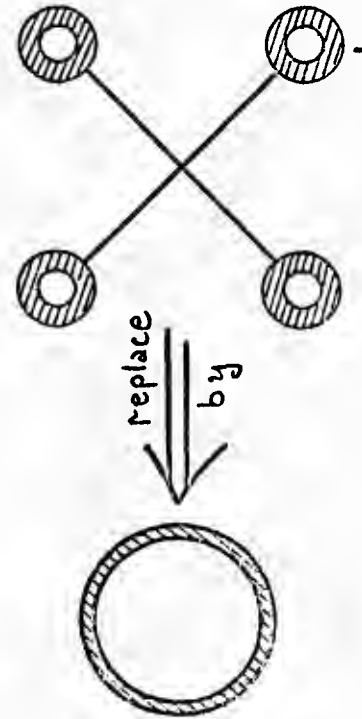

7.7.6 Crossbonded Cable

Professor Aki Ametani implemented a crossbonded cable model in the EMTP during the summer of 1981 when he was under a contract with BPA. The details of the mathematical model can be found in Aki's contract report titled: "Crossbonded Cable Modeling in EMTP", dated October 12, 1981. Most of the following texts are taken from Aki's report.

A) Introduction

It is a quite common practice to crossbond a three-phase PV or CV cable, i.e. single-core coaxial cable with a polyethylene or oil-immersed paper insulation, so that a circulating current within the sheaths is reduced. A schematic diagram of a crossbonded cable is given in Fig.1. In general, a crossbonded cable consists of cascaded major sections of more than ten as shown in Fig. 1(a). One major section consists of three minor sections as illustrated in Fig.1(b). The sheaths are crossbonded at the ends of the first and second minor sections. As a common practice, the length of one minor section is between 300m to 500m, thus, the length of one major section is about 1km to 1.5km. At the junction of each major section, the sheaths of the three phases are short circuited and grounded. Because of the existence of a resistance at the grounding point due to a poor conductivity of a soil,

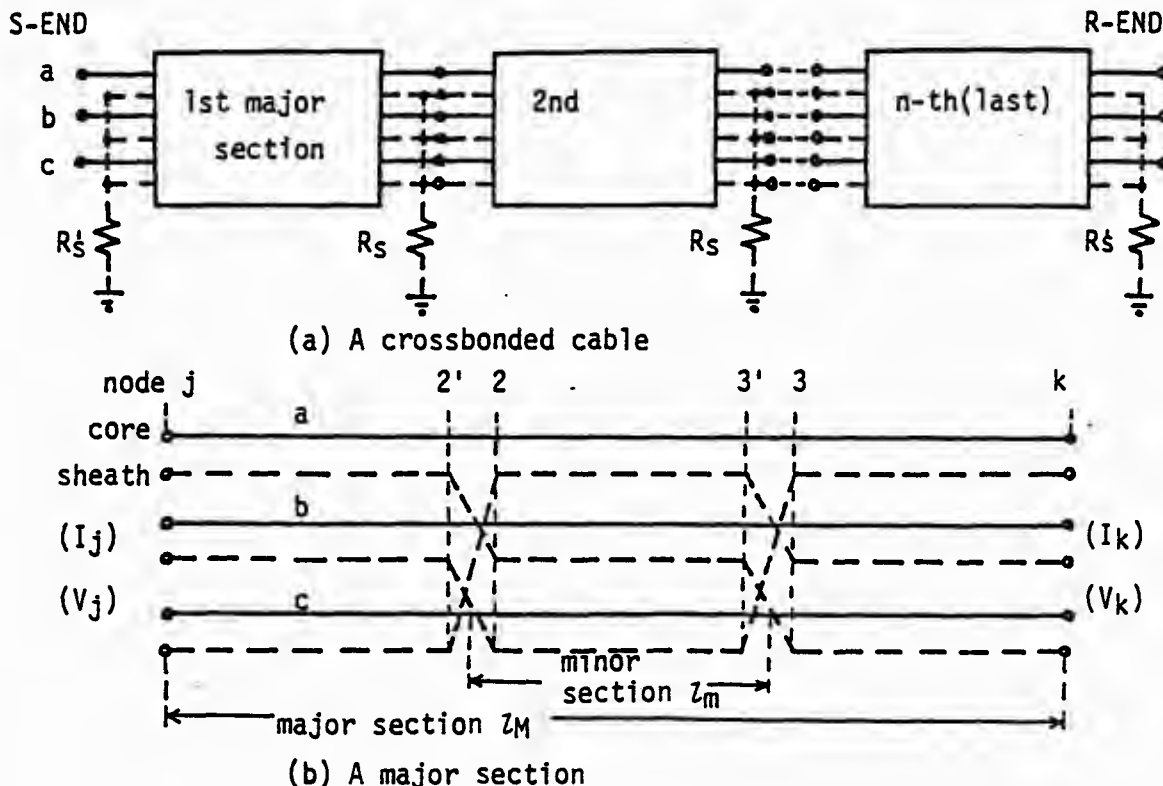

Fig.1 A schematic diagram of a crossbonded cable

it looks like the sheaths are grounded through the resistance of R_s as shown in Fig.1(a). At the sending and receiving ends of a cable, the resistances are lower than those at each major section, because of higher degree of grounding. (The details of grounding should be found in the standard of electrical apparatus or machinery, possibly in the ANSI.)

Thus, the resistances at the sending and receiving ends are given by R_s' which is different from R_s . In practice, R_s is 1Ω to some tens ohm, and R_s' 0.1Ω to 10Ω depending upon the way of grounding.

B) Modeling of a Crossbonded Cable

A crossbonded cable can be modeled as the uniform distributed parameter line. An equivalent circuit to one major section of the crossbonded cable is shown in Fig. 6. Z'' and Y'' are the equivalent series impedance and shunt admittance respectively of one major section. Note that this equivalent circuit is a four-

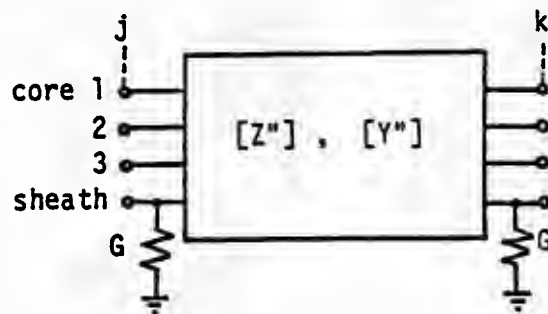

Fig.6 An equivalent uniform distributed-parameter line to one major section

conductors system but not six-conductors system. This is due to the fact that the effect of the short-circuit of the three-phase sheath has been taken into account in this equivalent circuit, and thus three sheaths are reduced to one sheath. The sheath voltage in the equivalent circuit of Fig.6 is the same as the voltages of the three sheaths in the original circuit of Fig.1 or Fig.5, and the sheath current in the equivalent circuit is the sum of the three-phase sheath currents in the original circuit.

Also, it should be noted that the grounding conductance G is not taken into account in this equivalent circuit. Thus, the conductance G should be included as a boundary condition between two major sections.

The above equivalent circuit can be adopted to the EMTP, because it is a uniform distributed-parameter line.

A PI-circuit equivalent is quite often used to represent a distributed-parameter line, although it can not take into account the frequency-dependent effect of the distributed-parameter line.

(1) Accurate modeling

Each minor section is represented by a six-phase PI-circuit, and is connected as shown in Fig.1(b). Then, each major section is connected as shown in Fig.1(a) including a grounding resistance.

(2) Uniform line modeling

Each major section is represented by a four-phase PI-circuit of which R , L and C are given by Z'' and Y'' of Fig. 6, i.e. $Z'' = R + j\omega L$ and $Y'' = j\omega C$. Then, each major section is connected as shown in Fig.1(a) including a grounding resistance.

C) Data Format for Using the Crossbonded Cable Model

The data structure for using the crossbonded cable model is same as that for the usual (not crossbonded) cable (see Section 7.7.2), except the following two additional data cards are needed:

- (1) A card with "PUNCH" inputted in columns 1-5 should be put right after the "CABLE CONSTANTS" card (see "A2" and "B2" of Section 7.7.2).
- (2) Then, the following card should be inputted after the "miscellaneous data card" which was described as "A3" and "B3" data in Section 7.7.3:

1	2	3	4	5	6	7	8	9	10	11	12	13	14	15	16	17	18	19	20	21	22	23	24	25	26	27	28	29	30	31	32	33	34	35	36
NPAIS					NCROS					IRSEP					XMAJOR										RSG					CNAME					
15					15					15					E10.1										E10.1					A1					

Definition of each variable of the above data card is :

NPAIS : number of PI-sections a user should define except "NPAIS = 0".

The detailed explanation for 'NPAIS' will be given later.

NCROS : "NCROS \neq 0" corresponds a crossbonded cable.

"NCROS = 0" corresponds a usual (not crossbonded) cable.

For the overhead line case, leave BLANK.

IRSEP : "IRSEP = 0" means that all the cable sheaths are short-circuited and grounded through resistance 'RSG' between each PI-section.

"IRSEP \neq 0" means that each sheath is grounded separately from each other through resistance 'RSG' between each PI-section.

If 'IRSEP' is left BLANK, IRSEP is taken to be '0'.

IRSEP dose not apply for the overhead line case and also for the cable case when "NPAIS.GT.0". Thus, in such the case, leave 'IRSEP' to be BLANK.

XMAJOR : length of one major section for "NPAIS.LT.0" in the cable case.

length of one PI-section for "NPAIS.GT.0" in the cable case and in the overhead line case.

'XMAJOR' should equal to the length given by the total length of a cable or line divided by 'NPAIS', or

'total length' = 'XMAJOR' * 'NPAIS'

RSG : sheath grounding resistance at the end of a major section for a cable.

'RSG' dose not apply to the overhead line case, thus leave BLANK.

CNAME : node name of PI-circuit modeling a user should define in the case of "NPAIS.NE.0". For "NPAIS = 0", leave BLANK.

More detailed explanation for 'NPAIS' and the related variables is given hereafter.

[A] NPAIS \neq 0 : Data cards of a line or cable by PI-circuit modeling will be punched out.

(A-1) For the cable case (ITYPE \neq 1)

(1) NPAIS.GT.0 : Uniform PI-Circuit Modeling

(1-1) NCROS = 0 or BLANK : Usual cable (non-crossbonded cable)

(a) A user will get a cascade PI-circuit modeling shown in Fig.7 for a given

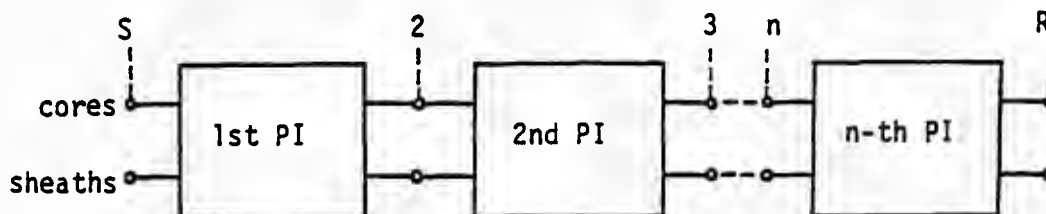

Fig.7 Uniform PI-circuit modeling for a non-crossbonded cable

distributed-parameter line. There is no grounding resistance and no connection rather than the cascade connection between two PI-sections. Thus, 'IRSEP' and 'RSG' should be BLANK.

(b) The number of PI-sections is given by 'NPAIS' ($n = \text{NPAIS}$ in Fig.7). NPAIS is arbitrary and thus, a user should define it. But the following relation should be always satisfied.

$$\text{'total length of a cable'} = \text{'NPAIS'} * \text{'XMAJOR'}$$

(c) The user should define the node name of his PI-circuit modeling by 'CNAME'. The data for 'CNAME' is one alphabetic letter and is read by format "A1". Then, all the node names in this PI-circuit modeling are internally determined in the following form.

At the sending-end :

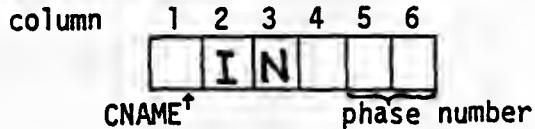

At an intermediate node :

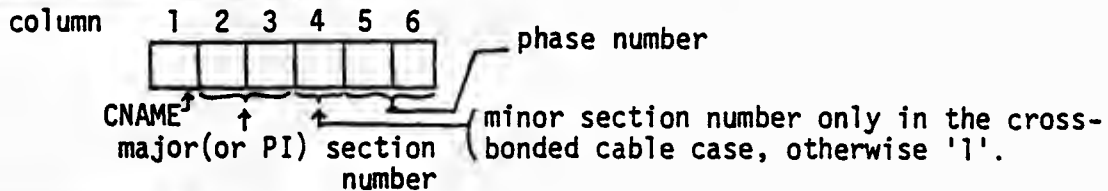

At the receiving-end :

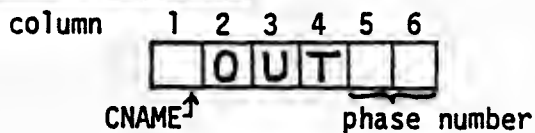

(1-2) NCROS \neq 0 : Crossbonded cable

(a) A user will get a PI-circuit modeling shown in Fig.8 for a given crossbonded cable. Each PI-section corresponds one major section of the crossbonded

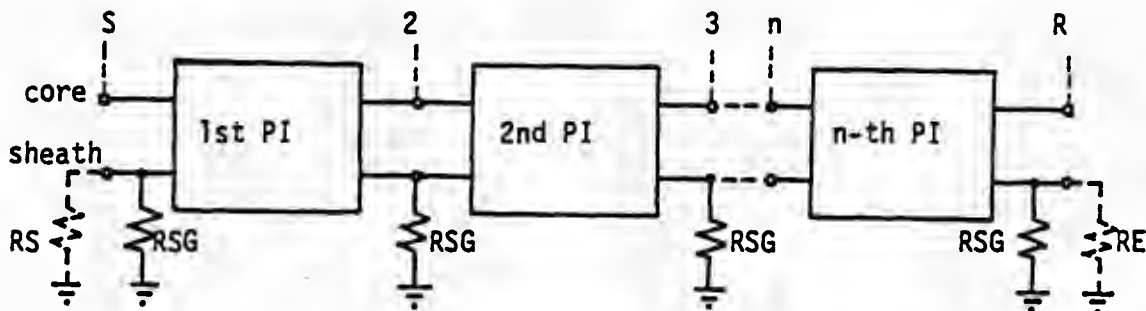

Fig.8 Uniform PI-circuit modeling for a crossbonded cable

cable, and R, L and C are calculated in the method explained in Sec.3.2. There is a grounding resistance 'RSG', and thus the user should define the value of 'RSG' in his second Misc. Data Card. But no need to define 'IRSEP', because there exists only one sheath as explained in Sec.3.2.

(b) For each PI-section corresponds to one major section, the number of the PI-section is not arbitrary, and should be identical to the number of the major sections in the given crossbonded cable, i.e.

$$\text{'NPAIS'} = \text{'total length of the cable'} / \text{'XMAJOR'}$$

(c) Same as (c) in the case of (1-1).

(d) A user should add the parallel resistances 'RS' and 'RE' to the 'RSG' at the sending- and receiving-ends as shown in Fig.8 after he gets the punched out data cards for his PI-circuit modeling, because the grounding resistances at the both ends are, in general, different from 'RSG'. In other words, the user can get the correct grounding resistances by adding 'RS' and 'RE', i.e.
 'correct resistance at the sending-end' = $(1/RSG + 1/RS)^{-1}$
 'correct resistance at the receiving-end' = $(1/RSG + 1/RE)^{-1}$

(2) NPAIS.LT.0 : Discrete PI-Circuit Modeling

(2-1) NCROS = 0 or BLANK : Usual cable

(a) A user will get a PI-circuit modeling shown in Fig.9(which is the same as Fig.8 in fact) for a given cable. Each PI-section corresponds one major section of the cable. There is a grounding resistance 'RSG', and thus, the user should define the value of 'RSG'. Also, 'IRSEP' should be defined, although, in most practical cases, the sheaths are short-circuited and grounded, i.e. "IRSEP = 0".

(b) to (d) Same as those given in the case of (1-2).

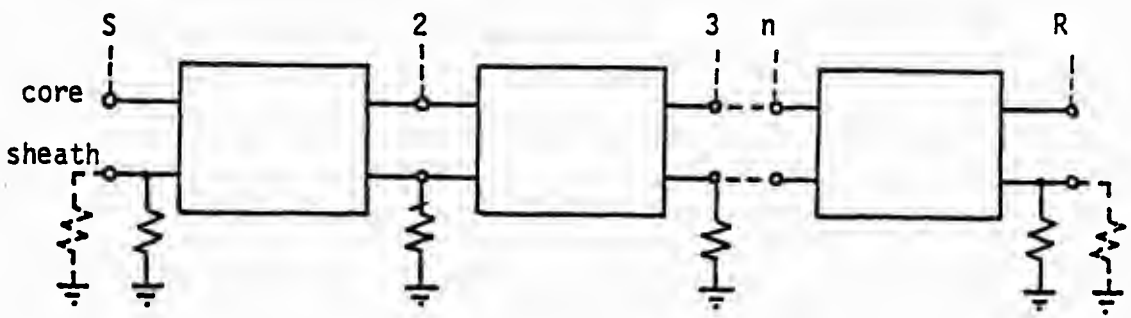
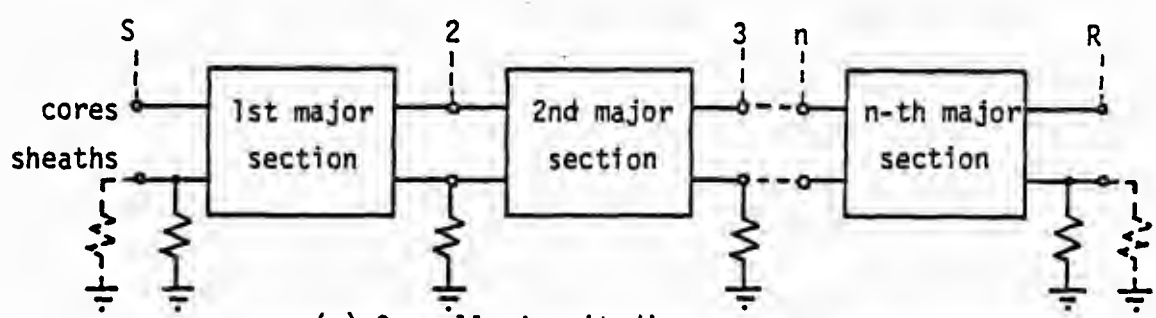

Fig.9 Discrete PI-circuit modeling for a usual cable

(2-2) NCROS ≠ 0 : Crossbonded cable

(a) In this case, a user will get a PI-circuit modeling shown in Fig. 10. One major section consists of three PI-circuits, of which each PI-circuit corresponds one minor section. Within one major section, crossbonding of three-phase sheaths are carried out. Since there is a grounding resistance, the user should define its value. Also, IRSEP should be defined.



(a) Overall circuit diagram

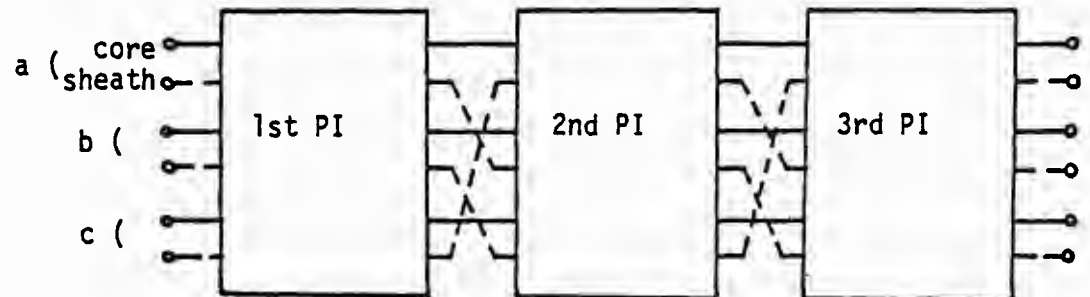

(b) One major section

Fig.10 Discrete PI-circuit modeling for a crossbonded cable

(b) The number of major sections is given by 'NPAIS' and is not arbitrary. The user should give the actual number of the major sections of his cross-bonded cable as 'NPAIS' in his data card, but the following condition should be kept.

'total length of the cable' = 'NPAIS' * 'XMAJOR'

(c) and (d) Same as those in the case of (1-2).

(A-2) For the overhead line case (ITYPEC = 1)

In this case, 'NPAIS' should be greater than '0' ("NPAIS.GT.0."). The model circuit configuration and the data input are the same as those explained in the case of (1-1) : NCROS = 0 of (A-1) for the cable case.

[B] NPAIS = 0 or BLANK : No data card punchout

(1) NCROS = 0 or BLANK

In this case, a user will get exactly the same version of the CABLE CONSTANTS as that in the last year (1980 Version). Thus, leave BLANK all the data in the second Misc. DATA CARD.

(2) NCROS ≠ 0 : Crossbonded cable

This is only for the cable case (ITYPEC ≠ 1). In this case, 'XMAJOR' should be defined. A user will get printouts of various cable parameters for his crossbonded cable as same as those in the case of "NCROS = 0".

Summarizing all the above explanation for the 2nd Misc. Data Card, the following table is obtained.

Table 1 Data for 2nd Misc. Data Card	
NPAIS < 0	: need all the data
NPAIS > 0 & NCROS ≠ 0	: need all the data
NPAIS > 0 & NCROS = 0	: need 'XMAJOR' and 'CNAME'
NPAIS = 0 & NCROS ≠ 0	: need only 'XMAJOR'
NPAIS = 0 & NCROS = 0	: no data, just one BLANK card
ITYPEC = 1 : "NPAIS < 0" can not be used.	

Following is an example of PI-circuit modeling of a crossbonded cable with one major section. The cable configuration is illustrated in Fig. 11. A cable consists of core, sheath and armor. The armors are solidly grounded and the sheaths are crossbonded. To eliminate the grounded armors, 'NGRND' (No. of solidly grounded conductors) is taken as '3'. Since the cable is crossbonded,

'NCROS' = '1' (or not equal to zero). The sheaths being short-circuited and grounded at the both ends of the major section, 'IRSEP' = '0' and 'RSG' = '0.1' (Ω).

In the same manner, one can handle a cable of which the both armors (or pipe) and sheaths are grounded, using the Discrete PI-Circuit Modeling, i.e. use 'NGRND' for grounding the armors or pipe and ground the sheaths by 'RSG' and 'IRSEP'.

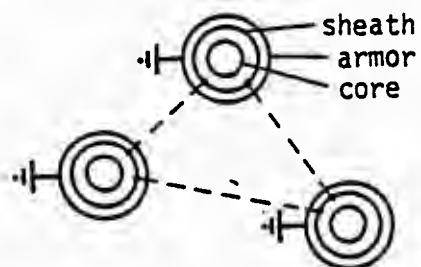

Fig.11 A three-phase crossbonded cable

BEGIN NEW DATA CASE
 C TEPCO OF275KV SC CABLE *****
 CABLE CONSTANTS
 PUNCH

2	-1	3	0	1	1	1	0	3			
-1	1	0		1.E3		1.E-1A					
3	3	3									
0.0132		0.0249		0.0542		0.057		0.063		0.066	0.072
1.89E-8		1.		1.		2.3		3.0E-8		1.	1.
3.E-8		1.		1.		3.5					3.5
0.0132		0.0249		0.0542		0.057		0.063		0.066	0.072
1.89E-8		1.		1.		2.3		3.0E-8		1.	1.
3.E-8		1.		1.		3.5					3.5
0.0132		0.0249		0.0542		0.057		0.063		0.066	0.072
1.89E-8		1.		1.		2.3		3.0E-8		1.	1.
3.E-8		1.		1.		3.5					3.5
2.		0.		1.8095		0.11		2.		0.22	
		1.E2		1.E3							

BLANK CARD ENDING FREQUENCY CARDS
 BLANK CARD ENDING "CABLE CONSTANTS" DATA CASES
 BEGIN NEW DATA CASE
 BLANK

The PI-circuit branch cards resulted on the punch file LUNIT7 are:

```

$VINTAGE, 1
  AIN 4 0.10000E+00
  1AIN 1A 11 1 0.32000E-01 0.65728E-01 0.54835E-01
  2AIN 2A 11 2 -0.29431E-04 -0.48708E-05 0.00000E+00
  3AIN 3A 11 3 0.32000E-01 0.65728E-01 0.54835E-01
  4AIN 4A 11 4 -0.29426E-04 -0.48708E-05 0.00000E+00
  5AIN 4A 11 5 -0.29431E-04 -0.48708E-05 0.00000E+00
  6AIN 4A 11 6 0.20414E-01 0.87682E-02 0.40174E+00
  1A 11 1A 12 1AIN 1A 11 1 0.32000E-01 0.65728E-01 0.54835E-01
  2A 11 2A 12 2 -0.29431E-04 -0.48708E-05 0.00000E+00
  3A 11 3A 12 3 0.32000E-01 0.65728E-01 0.54835E-01
  4A 11 4A 12 4 -0.29426E-04 -0.48708E-05 0.00000E+00
  5A 11 5A 12 5 -0.29431E-04 -0.48708E-05 0.00000E+00
  6A 11 6A 12 6 0.20414E-01 0.87682E-02 0.40174E+00
  1A 12 1AOUT 1AIN 1A 11 1 0.32000E-01 0.65728E-01 0.54835E-01
  2A 12 2AOUT 2 -0.29431E-04 -0.48708E-05 0.00000E+00
  3A 12 3AOUT 3 0.32000E-01 0.65728E-01 0.54835E-01
  4A 12 4AOUT 4 -0.29426E-04 -0.48708E-05 0.00000E+00
  5A 12 5AOUT 4 -0.29431E-04 -0.48708E-05 0.00000E+00
  6A 12 6AOUT 4 0.20414E-01 0.87682E-02 0.40174E+00
  AOUT 4 AIN 4
$VINTAGE, 0
  
```

10. INDEX OF EMTP RULE BOOK

Topic of Interest to EMTP User	Page

[A],[B] matrix option. See "USE AB", "BCTRAN".	
"ABORT DATA CASE" to prevent solution (Sect. 1.0e2)	4b
"ABSOLUTE TACS DIMENSIONS" to size TACS tables (Sect. 1.0e5)	4b-2
"ABSOLUTE U.M. DIMENSIONS" to size U.M. tables (Sect. 1.0e14)	4c-3
Accumulator and counter, Type-65 TACS device (Sect. 8.5.5)	311
Acknowledgement of contributing parties (Sect. 0.2)	iv-a
ACOS version of EMTP (for NEC ACOS computers (Sect. 0.5a)	x-a
Active gap of surge arrester, Type-94 (Sect. 1.34)	25a
Address limitations of some computers (Sect. 0.)	iv-a1
Aegis. See Apollo	
"ALTERNATE DIAGNOSTIC PRINTOUT" definition (Sect. 1.0g8)	4e-9
Analog computer simulation using TACS (Sect. 8.)	274
"ANALYT" subroutine for user-supplied FORTRAN (Sect. 1.9c)	39a
"ANALYTIC SOURCES USAGE" signals use of "ANALYT" (Sect. 1.0g1)	4e-1
Anode of valve/diode switch component (Sect. 1.43)	30c
Apollo version of EMTP (Sect. 0.5r)	x-r
Armor of "CABLE CONSTANTS" (Sect. 7.7.1)	251
"ARRDAT" routine for ZnO exponential fitting (Sect. 7.2b)	103h
Arrester modeling. See "Surge arrester modeling".	
Australian EMTP Users Group (Section 0.1)	iv-e
Availability of program (Section 0.1)	iv
"AVERAGE OUTPUT" to remove EMTP noise (Sect. 1.0e4)	4b-1
Base value of statistical tabulation (Sect. 1.8b, BASE)	38c-1
"BCTRAN" subroutine for 3-phase transformers (Sect. 7.1B)	100g
"BEGIN NEW DATA CASE" for data case separation (Sect. 1.0a)	4
"BEGIN PEAK VALUE SEARCH" for delayed extrema (Sect. 1.0e11)	4c
Belgium. See "European EMTP Users Group"	
Bessel functions of line constants. See "Skin effect".	
Blank card (data case) to terminate EMTP execution (Sect. 1.0b)	4a
"BLANK " cards of data case (Sect. 1.-a)	1a
Bonneville Power Administration (Sect. 0.2)	iv-a
BPA. See "Bonneville Power Administration".	
Branch cards as EMTP data classification (Sect. 1.-a-4)	1
Branch flows of phasor steady-state	41
Branch output variables (Sect. 1.8a, Branch outputs)	38a
Brandwajn, Dr. Vladimir. See Sect. 1.62 mention.	34d
Brazilian EMTP Users Group. See "Latin American...".	
Bundling of conductors in "LINE CONSTANTS" (Sect. 7.4, II-3.)	146
Burroughs version of EMTP (Sect. 0.5a)	x-a
"CABLE CONSTANTS" request for transfer to it (Sect. 1.0g)	4e
"CABLE CONSTANTS" supporting routine (Sect. 7.7)	251
CalComp. See "Plotting of EMTP results", "Proprietary software".	
Capacitance modeling in the EMTP. See:	
Linear, single-phase representation (Sect. 1.21)	6
Linear, multi-phase [C] (Sect. 1.23)	9
For delta-connected transformer (Sect. 1.25, end)	12j
"LINE CONSTANTS" formulas (Sect. 7.4, II-2.2)	144
Carson's formula for "LINE CONSTANTS" (Sect. 7.4, App.)	167
"CASCADED PI" feature, for phasor solutions (Sect. 1.22)	7

Case title text of plotting (Sect. 1.10B, Point 1)	40c
Cathode of valve/diode switch component (Sect. 1.43)	30c
CDC (Control Data) version of EMTP (Sect. 0.5a)	x-a
Change existing S.M. data for solution using U.M. (Sect. 1.63J)	36m-3
"CHANGE PRINTOUT FREQUENCY" of DELTAT-loop (Sect. 1.0e10)	4c
Checkpoint for EMTP execution: see "START AGAIN", "MEMSAV".	
Circuit breaker modeling. See "Switches; ordinary".	
"CLAMP" signal of TACS-controlled switch (Sect. 1.44)	30f
"CLOSED" request of valve/diode card (Sect. 1.43, Rule 5)	30d
Coaxial cable parameters. See "CABLE CONSTANTS".	
Combination of Monte Carlo results. See "TABULATE ENERGIZATION ...".	
Comment card, used in data case (Sect. 1.-a)	1a
Compensation, number of phases (Sect. 0.6, List 24, NCOMP)	xiii-2
Compensation technique of handling nonlinearities	17a
Compensation use or non-use with U.M. (Sect. 1.63-K, ICOMP)	36i-9
COMPLEX (FORTRAN) precision limits (Sect. 7.7.1, Restriction 2)	252
Computers. See "Installation dependent information".	
Conductor card of "LINE CONSTANTS" (Sect. 7.4, Point 3)	116
Connectivity printout (misc. data param. IDOUBL, Sect. 1.0h)	4f-1
Connectivity requirement of network solution:	
for phasor solution (Sect. 2.2b, Message 11)	47c
for delta-connected transformers (Sect. 1.25, end)	12j
Contributors. See "Maintenance".	
Control system modeling. See "TACS"	274
Controlled integrator, Type-58 TACS device (Sect. 8.5.5)	306
"CONVERT" routine for flux-current curve (Sect. 7.2)	101
"CONVERT ZNO" to convert old ZnO branch cards to new formats	4e-12
Converter model, HVDC, Type-16 source (Sect. 1.61)	34a
"COPT" units for capacitance. see "Miscellaneous data cards".	
"COPY" request of reference branch usage (Sect. 1.-E)	3c
Core of "CABLE CONSTANTS" (Sect. 7.7.1)	251
Core-type transformers. See "BCTTRAN", "TRELEG" (Sect. 7.1A, B).	
Corvallis, Oregon. See "Universal Machine".	
Cray-1 version of EMTP (Sect. 0.5a)	x-a
Cross-bonded cable modeling (Sect. 7.7.6)	270
Current outputs. Refer to components of interest.	
Current source modeling. See "Source cards".	
"CUSTOM PLOT FILE" to alter plot file precision (Sect. 1.0g9)	4e-9
Damping of mass. See "Rotating machinery".	
Damping of transients. See:	
"hash" for discussion of spurious switch-related noise.	
Ref. 22, Vol. 2, No. 3, Editors' Note, page 1 for damping resistors.	
Daniel. See "Van Dommelen".	
Data General (DG) version of EMTP (Sect. 0.5e)	x-e
DC converter. See "Converter", "valve", "TACS".	
DC motor/generator modeling. See "Universal machine (U.M.)".	
Debugging of problem solutions. See "DIAGNOSTIC".	
DEC. See "VAX", "PDP-10", "SYSTEM20".	
Default List Sizes (Sect. 0.6)	iv-1
"DEFAULT" request of "JMARTI SETUP" (Sect. 7.0)	93a-1
Deionization time of valve (Sect. 1.43, Rule 4b)	30d
"DELTA CONNECTION" of S.M. armature windings (Sect. 1.62a, Class 2)	34j
"DELTAT" time-step size definition. See "Miscellaneous data".	
Derivative, Type-59 TACS device (Sect. 8.5.5)	307
Devices of TACS control system modeling (Sect. 8.5.5)	298
"DIAGNOSTIC" printout for debugging (Sect. 1.0g7)	4e-7
Dice. See "Random number", "STATISTICS".	

Digital computers. See "Installation dependent information".	
Digitizer, Type-55 TACS device (Sect. 8.5.5)	303
Dimensions of EMTP tables. See "variable dimensioning".	
Diode switch component (Sect. 1.43)	30c
Directories of data. See Modularization.	
"\$DISABLE" for implicit commenting (Sect. 1.-D)	3b
Disclaimer of any responsibility for misuse (Sect. 0.1)	iv
Discontinuity (possible) at t=0 from reactors (Sect. 1.29 end)	16i
Distortionless line modeling (Sect. 1.26)	13d
Distributed modeling. See "Transmission line".	
Distribution of random numbers. See "STATISTICS".	
Dollar-cards (\$-cards) for special file operations (Sect. 1.-D)	3b
Doshisha University. See "Japanese ...", "CABLE CONSTANTS"	
Double-circuit transmission line representation. See:	
Transposed model with zero sequence coupling (Sect. 1.26a)	15b
Recursive convolution modeling (Sect. 1.27)	16c-1
Dube, Mr. Laurent Dube (Sect. 8.)	274
Dynamic limiter of TACS (Sect. 8.5.3)	289
Dynamic synchronous machine. See "Synchronous machine".	
Earth wires of transmission lines. See "Ground wires".	
ECNSW. See "Australian EMTP"	
Education of program users (See Sect. 0.)	iv-a
Elliott, Dr. Brian J., of ECNSW. See "Australian EMTP ..."	
Empirical specification of EMTP sources (Sect. 1.9b)	39
"\$ENABLE" to cancel "\$DISABLE" (Sect. 1.-D)	3b
"EPSILN" singularity tolerance. See "Miscellaneous data cards".	
Equivalent-Pi of "LINE CONSTANTS" by doubling (Sect. 7.4, App. 6)	186
Error messages of program; fatal ones (Sect. 2.4)	50
European EMTP Users Group (Sect. 0.)	iv-a
Exciter modeling for generators (Sect. 1.62a, Class 6, Rule 1)	34h
Exponential tails. See "Tails of weighting functions".	
Exponential ZNOEXP of ZnO arrester equation (Sect. 1.32)	17
Exponentials of recursive convolution (Sect. 1.27)	16c-1
Extensions to misc. data cards (Sect. 1.1)	5
Extrema of solution variables. See:	
Request MAXOUT of misc. data (Sect. 1.0h)	4g
"BEGIN PEAK VALUE SEARCH" for delay (Sect. 1.0e11)	4c
"PEAK VOLTAGE MONITOR" for 1 peak node volt. (Sec. 1.0e13)	4c-2
"STATISTICS" for use in Monte Carlo studies.	
FACOM version of EMTP. (Sect. 0.5a)	x-a
Fatal error messages. See "Error messages".	
"FAULT DATA USAGE" for source equivalent (Sect. 1.0g13)	4e-11
"FILE REQUEST" to call "MIDOV1" module (Sect. 1.0e)	4b
"FINISH" card for S.M. TACS connections (Sect. 1.62a, Class 6)	34y
"FIX SOURCE" to declare later load flow use (Sect. 1.0e12a)	4c-1a
Flashover (or spark) gap. See:	
Flashover switch (Sect. 1.40, Class 2)	27
Type-99 pseudo-nonlinear resistance (Sect. 1.28)	16d
Sect. 1.35 onward for use with compensation-based elements	
Floating delta problem of transformers (Sect. 1.25 end)	12j
Floating Point Systems. See "FPS-164 version"	
Font, character. See "Apollo version of EMTP".	
Format specifications for data; general (Sect. 0.7)	xviii
Fourier analysis of EMTP variables (Sect. 1.10, Rule 6, Point 16)	43h
FPS-164 version of EMTP (Sect. 0.5a)	x-a
Free-format of TACS supplemental variables (Sect. 8.5.5-A)	296

"FREE FORMAT" request to redefine characters (Sect. 1.0g6)	4e-6
Free-format usage, general. See "Format specifications".	
Frequency card of "LINE CONSTANTS" (Sect. 7.4, Point 4)	121
Frequency-dependent sources (List 27, LSIZ27)	xiv
Frequency-dependent transmission line modeling. See:	
Recursive convolution, "SEMLYEN SETUP"	
"WEIGHT" or weighting functions	
"JMARTI SETUP".	
Frequency meter, Type-50 TACS device (Sect. 8.5.5)	299
Frequency of output ("IOUT" and "IPLOT" of Sect. 1.0h)	4f-1
"FREQUENCY SCAN", to loop over phasor solutions (Sect. 1.0g3)	4e-2
Function block of TACS (Sect. 8.5.1)	286
FURNAS. See "Latin American EMTP User Group".	
Gain of TACS transfer function block (Sect. 8.5.1)	286
Gap: see also "Flashover (or spark) gap".	
Gap, as TACS-controlled EMTP switch type (Sect. 1.4)	26
Gap, in ZnO arrester model (Sect. 1.32)	17
Generalized machine. See "Universal Machine".	
Governor modeling of generator. See "Rotating machinery".	
Graphical output. See "Plotting of EMTP results."	
"GRID" firing signal of valve (Sect. 1.43)	30c
Ground (local) of electric network, blank name (Sect. 1.-b)	1a
Ground wires of "LINE CONSTANTS" (Sect. 7.4, cond. card, IPHASE)	116
Ground modeling. See "Carson", "Nakagawa".	
Grounding of conductors of the cable (Sect. 7.7.3, NGRND)	257
Harmonic content of signals. See "Fourier analysis".	
Harris version of EMTP (Sect. 0.5a)	x-a
Hash in EMTP solutions, due to switch opening	28a
"HEIGHT" adjustment for plot (Sect. 1.10B, Point 6)	41
Heverlee, Belgium. See "Van Dommelen" or "European EMTP ...".	
Hewlett-Packard 9000 version of EMTP (Sect. 0.5i)	x-i
High precision option for data formats. See "\$VINTAGE".	
"HIGH RESISTANCE" to alter internal high R value (Sect. 1.0c)	4a-1
HITAC version of EMTP, for Hitachi HITAC computer. (Sect. 0.5a)	x-a
Hitachi, Ltd. See "HITAC version".	
Holding current of valve/diode (Sect. 1.43, IHOLD)	30c
Honeywell version of EMTP (Sect. 0.5a)	x-a
HVDC. See "Converter", "Valve", "TACS".	
Hysteresis modeling, magnetic. See:	
Branch cards for Type-96 reactor (Sect. 1.31)	16L
"HYSDAT" routine to generate characteristic (Sect. 7.2a)	103b
IBM version of EMTP (Sect. 0.5b)	x-b
ICL version of EMTP (Sect. 0.5a)	x-a
Ideal transformer as network component (Sect. 1.6, Type 18)	32b
IF-component, Type-60 TACS device (Sect. 8.5.5)	307
Ignition voltage of valve (Sect. 1.43, Rule 4a)	30d
Illustration of usage. See "Sample EMTP simulation."	
Index. You're reading it, human (a non-sexist "fella").	
Indian EMTP Users Group (Sect. 0.1)	iv-a
Inductance (inductor) modeling. See "Reactance....".	
Induction machine modeling using U.M. (Sect. 1.63H)	36k
Initial condition specification for EMTP variables. See:	
Cards to over-ride electric network initial cond. (Sect. 1.7)	37
Cards to specify (no over-ride) TACS init. cond. (Sect. 8.5.7)	308
Injection printout of generator phasor voltage sources	41

Input supplemental variables (Type 99) of TACS (Sect. 8.5.5)	295
Inside supplemental variables (Type 88) of TACS (Sect. 8.5.5)	295
Input/output unit numbers of EMTP (Sect. 0.5-5.)	viii-5
Installation-dependent information (Sect. 0.5)	viii
General, for all computer systems of interest	viii
Specific computer systems (Sect. 0.5a to 0.5q)	x-a
Instantaneous min/max, Type-63 TACS device (Sect. 8.5.5)	310
Insulator layers of "CABLE CONSTANTS" (Sect. 7.7.1)	251
Interactive CRT plotting of EMTP results (Sect. 5.0A)	86
Interactive EMTP execution, observation, control (Sect. 9, missing)	
Interpretation of input data cards (Sect. 2.1)	44
Introductory information (Sect. 0.)	iv
Iterations. See "Load Flow".	
Japanese EMTP Committee (Sect. 0.5p)	x-p
Japanese computers. See "ACOS", "FACOM", "HITAC"	
"JMARTI SETUP" for frequency-dependent line data (Sect. 7.0)	93a-1
"JMARTI SETUP" request for transfer to it (Sect. 1.0g)	4e
Jose. See "Marti".	
Karrenbauer transformation for transposition (Sect. 4.1)	82
KILL code number of error stops. See "Error messages".	
"KILL CODES" to test EMTP error stops (Sect. 1.0e3)	4b-1
K.U. Leuven. See "European EMTP Users Group" or "Van Dommelen"	
Kyoto (Japan). See "Japanese EMTP ..."	
Latin American EMTP User Group (Sect. 0.1)	iv-a
Laurent. See "Dube", "Lighthouse".	
Lawrence Livermore Laboratory. See "Cray-1 version".	
Leakage inductance from self and mutual, for U.M. (Sect. 1.63B)	36f
Lee, Dr. K. C. of B.C. Hydro. See "Untransposed ...".	
Leuven (Belgium). See "Van Dommelen" or "European EMTP ...".	
Level-triggered switch, Type-51 TACS device (Sect. 8.5.5)	300
Library functions, FORTRAN-like, of TACS (Sect. 8.5.5)	296
Lighthouse keeper. See "Dube", "TACS".	
Lightning arrester modeling. See "Surge arrester".	
"LIMIT ON PLOT OSCILLATIONS" for averaging (Sect. 1.0c, NSMTH)	4a-1
Limiters for control variables of TACS (Sect. 8.5.3)	289
"LINE CONSTANTS" request for transfer to it (Sect. 1.0g)	4e
"LINE CONSTANTS" supporting routine (Sect. 7.4)	113
"LINEAR BIAS USAGE" for ramped switch bias (Sect. 1.0g5)	4e-e
"\$LISTOFF/ON" to control data card listing (Sect. 1.-D)	3b
List sizes. See "Variable dimensioning".	
Literature. See "Reference material".	
Liu, Dr. Tsu-huei, of BPA. See "Program Maintenance".	
Load flow (Sect. 1.66)	36s
Load flow for U.M. (Sect. 1.63L)	36p
Logical (Boolean) operators of TACS (Sect. 8.5.5-A)	296
Logical units of FORTRAN EMTP. See "Input/Output units ...".	
Lumped-resistance modeling for transmission line (Sect. 1.26)	13d
LUNIT assignments. See "Input/Output unit ...".	
Ma, Ren-ming, of Wu-han High Voltage Research Institute, PRC	iv-c
Machinery modeling. See "Rotating machinery".	
Magnetizing current or impedance of transformer. See:	
Saturable "TRANSFORMER" component (Sect. 1.25, Rule 2)	12e
Linear "XFORMER" specification (Sect. 7.1)	94
Linear "TRELEG" specification (Sect. 7.1a)	100b

Maintenance of program (Sect. 0.2)	iv-a4
Mass of rotor. See "Rotating machinery".	
Marti, Prof. Jose R., of Caracas, Venezuela (Sect. 1.26b1)	15g
Matrix inversion/reduction formulas. See "Shipley".	
Mechanical network. See "Rotating machinery".	
Memoranda, EMTF, Ref. 8 of Sect. 0.4 References	vi
Memory requirements. See "Variable dimensioning".	
MEMSAV = 1 request for table saving. See "START AGAIN".	
Metric CalComp plotting via "SCALE" (Sect. 1.10B, Point 14)	43e
"METRIC" option of "LINE CONSTANTS" (Sect. 7.4)	114
Meyer, Dr. W. Scott, of BPA. See "Program Maintenance".	
Microcomputers. See "Apollo version....".	
Minicomputers. See "VAX", "PRIME", etc.	
Min/max tracking, Type-64 TACS device (Sect. 8.5.5)	310
"MISCELLANEOUS DATA CARDS" by special request (Sect. 1.0e9)	4b-6
Miscellaneous data cards of simulation case (Sect. 1.0h)	4f
MMF of S.M. (Sect. 1.62a, Class 5, variable MFORCE or JSAT)	34r or u
Modal analysis theory of "LINE CONSTANTS" (Sect. 7.4, II-4.)	149
MODCOMP version of EMTF (Sect. 0.5a)	x-a
"MODE VOLTAGE OUTPUT"	4d
"MODIFY SWITCH LOGIC" to outwit Program Maint. (Sect. 1.0g12)	4e-11
Moment of inertia. See "Rotating machinery".	
Monte Carlo studies. See "STATISTICS".	
Motor. See "Rotating machinery".	
Multi-machine system sharing common mech. network (Sect. 1.63L)	36p-2
Multi-machine system simulation with the U.M. (Sect. 1.63K)	36n
Multiplicities of List Sizes (variable dimensioning)	xvi
Murphy's Law. See any section.	
Mutually-coupled R-L elements (Sect. 1.24)	12
Nakagawa. See "Stratified earth model".	
Name of branch or switch (Sect. 1.-E)	3b-1
"NAME" request. See "Name of branch".	
Narrow EMTF output. See "\$WIDTH", "OUTPUT WIDTH 80".	
Network connectivity. See "connectivity ...".	
Newsletter (EMTF Newsletter; Sect. 0.)	iv-a1
Node names of electric network (Sect. 1.-a)	1a
Node voltage output specification (Sect. 1.8a)	38
Non-fatal informative messages (Sect. 2.2b)	46a-1
Non-grounded EMTF sources (Sect. 1.-b)	2,3
Nonlinear elements. See "Resistance", "Reactance", etc.	
NTPC, India. See "India EMTF Users Group".	
Offsets of "VARDIM" data. See "Variable dimensioning ...".	
"OMIT BASE CASE" of STATISTICS run (Sect. 1.0e8)	4b-6
OPEN/CLOSE statement of FORTRAN (Sect. 0.5-6)	ix-1
"OPEN/CLOSE" signal of valve (Sect. 1.43, Rule 4c)	30d
Order of EMTF data cards. See "Structure of ...".	
Order of network nodes. See "RENUMBER BYPASS".	
Oregon State University. See "Universal Machine", "CDC version".	
Output scaling specification cards for statistical tabulation	38c-1
Output specification for electric network variables. See:	
a) Sect. 1.8a for detached specification	38
b) Any branch or switch for use of col.-80 punch.	
Output supplemental variables (Type 98) of TACS (Sect. 8.5.5)	295
"OUTPUT WIDTH 80" for 80-column output file (Sect. 1.0g10)	4e-10
"OUTPUT WIDTH 132" for 132-column output file (Sect. 1.0g11)	4e-10

"PAGE" request to begin "PRINTER PLOT" on new page (Sect. 10)	43m
Paging of computer. See "Virtual memory management".	
Parallel processing. See "Cray-1 version".	
"PARAMETER FITTING" of S.M. data (Sect. 1.62a, Class 2)	34h
Parenthesis usage for TACS grouping (Sect. 8.5.5-A, Rule 4)	297
Park's equations for rotating machine (Sect. 1.62, beginning)	34e-1
PDP-10 version of EMTP (Sect. 0.5a)	x-a
Peak values of solution variables. See "Extrema".	
"PEAK VOLTAGE MONITOR" for peak node voltage (Sect. 1.0e13)	4c-2
"PEN CHOICE" and grid status of plot (Sect. 1.10B, Point 11)	43
Pereira, Mr. Marco Polo. See "Latin American.....".	
Perkin-Elmer version of EMTP (Sect. 0.5a)	x-a
Personal Computer. See "Apollo.....".	
Phasor solution for initial conditions. See:	
Electric network printout (Sect. 1.0h, KSSOUT=1, 2, 3)	4j
Control system TACS usage (Sect. 8.4, Point 6)	285
Pi-circuit branch component (Sect. 1.23)	8
Pi-circuit punching (LUNIT7) (Sect. 7.4, IPUN of freq. card)	123a
Pipe-type cables. See "CABLE CONSTANTS".	
Plots of "STATISTICS" switch closing times (Sect. 1.8b, end)	38d
"PLOTTER PAPER HEIGHT" of CalComp plots (Sect. 1.0c)	4a
Plotting of EMTP results. See:	
Batch-mode plot card data requirements (Sect. 1.10)	40
Interactive CRT plotting (Sect. 5.)	86
PLOT10 graphics of Tektronix. See "Proprietary software".	
Point-by-point nonlinearity, Type-56 TACS device (Sect. 8.5.5)	304
Portland, Oregon. See "Program Maintenance".	
"POSTPROCESS PLOT FILE" using TACS (Sect. 1.0e17)	4c-6
Potential coefficient matrix [P] (Sect. 7.4, App. 1-b)	170
Power Constraints. See "Load flow".	
"POWER FREQUENCY" (system frequency) change (Sect. 1.0c, STATFR)	4a-2
Power output of branch or switch (Sect. 1.8a)	38a
Prayer. See "What to do in case of trouble".	
Price, Mr. Michael M., of AEP. See "IBM version.....".	
Prime mover of generator. See "Rotating machinery".	
PRIME version of EMTP (Sect. 0.5f)	x-f
"PRINT HEAD" usage for plot lettering (Sect. 1.10B, Point 10)	42
"PRINTER LINES PER INCH" scale of "PRINTER PLOT" (Sect. 1.0c)	4a
Printout of time-step loop. See:	
Variable IOUT of miscellaneous data (Sect. 1.0h)	4f-1
"CHANGE PRINTOUT FREQUENCY" request (Sect. 1.0e10)	4c
Output variable specification (Sect. 1.8)	38
Program Maintenance (Sect. 0.2)	iv-a
Proprietary software associated with EMTP	iv-a1
Pseudo-nonlinear element modeling of EMTP. See:	
Type-96 hysteretic inductor (Sect. 1.31)	16l
Type-98 nonlinear reactor (Sect. 1.29)	16g
Type-99 nonlinear resistor (Sect. 1.28)	16d
Pulse delay, Type-54 TACS device (Sect. 8.5.5)	302
Punched card output of EMTP (Sect. 0.5-5., LUNIT7)	viii-5
Random number generator testing (Sect. 1.1a, Point 3)	5c
Random number generator "RANDNM" (Sect. 0.5)	viii-2
Reactor modeling. See:	
for linear case, use series R-L-C branch (Sect. 1.21)	6
multi-phase, linear [L] (Sect. 1.24)	12
pseudo-nonlinear branch card, Type-98 (Sect. 1.29)	16g
Recursive convolution frequency dependence (Sect. 1.27)	16c-1

"REDEFINE TOLERANCE EPSILN" (Sect. 1.0c)	4a-1
Redimensioning of EMTP. See "Variable dimensioning".	
Reference branch usage to copy previous branches. See:	
a) any branch for explanation using terminal node names;	
b) Sect. 1.-E for usage with branch or switch names	3b-1
Reference Manual: former name for this work (Rule Book).	
Reference material (supporting literature; Sect. 0.4)	vi
Reference voltage ZNVREF of ZnO surge arrester (Sect. 1.32)	17b
References of "LINE CONSTANTS" (Sect. 7.4, end)	189
Relational operators (e.g., "EQ") of TACS (8.5.5-A)	296
"RELATIVE TACS DIMENSIONS" to size TACS tables (Sect. 1.0e5)	4b-3
"RELATIVE U.M. DIMENSIONS" to size U.M. tables (Sect. 1.0e14)	4c-3
Relay-operated switch, Type-51 TACS device (Sect. 8.5.5)	300
"RENUMBER BYPASS" request, to keep input order (Sect. 1.0g4)	4e-3
"REPLOT" request for plotting only (Sect. 1.0d)	4a-3
Reserved A6 names to be avoided (Sect. 1.-b)	1a
Residual flux of reactor. See:	
Type-93 switched-inductor usage (Sect. 1.41, Rule 4)	29
Type-96 hysteretic-inductor use (Sect. 1.31, Rule 5)	16n
Resistance (resistor) modeling of EMTP. See:	
Uncoupled, linear R-L-C branch (Sect. 1.21)	6
Multi-phase, linear [R] (Sect. 1.24)	12
Zinc-oxide surge arrester (Sect. 1.32)	17
Type-99 pseudo-nonlinear resistor (Sect. 1.28)	16d
Type-92 true nonlinear (Sect. 1.36)	21
Restrike modeling of breakers. Use TACS (Sect. 8.)	274
Revision date of Rule Book. See front cover.	
Right-adjustment of E-field numbers (Sect. 0.7)	xviii
RMS sensor, Type-66 TACS device (Sect. 8.5.5)	311a
Rotating machinery modeling. See:	
3-phase dynamic synchronous machine (Sect. 1.62)	34d
Universal machine model (Sect. 1.63)	36f
"SAME" request of valve/diode model (Sect. 1.43, Rule 6)	30d
Sample and track, Type-62 TACS device (Sect. 8.5.5)	309
Sample EMTP simulation, annotated output (Sect. 2.3)	49b
"SATURATION" request for transfer to "CONVERT" (Sect. 1.0g)	4e
Saturation effects, data, modeling. See:	
"Reactors" for modeling of saturable reactor.	
"CONVERT" for reactor saturation curve derivation	
for S.M. modeling (Sect. 1.62, Class 3, AGLINE, S1, S2)	34k
for U.M. modeling (Sect. 1.63G, Class 2, JSATD, LMSD)	36j-1
S-block. See "Function block of TACS".	
Scott. See "Meyer".	
Screening matrix of "LINE CONSTANTS" (Sect. 7.4, II-8)	164
Segmented ground wires in "LINE CONSTANTS" (Sect. 7.4, II-8.)	165
Sequence values (Zo, Z1) for coupled R-L (Sect. 1.24)	12b
SEL (Systems Engineering Laboratories) version (Sect. 0.5n)	x-n
"SEMLYEN SETUP" request for transfer to it (Sect. 1.0g)	4e
"SEMLYEN SETUP" supporting routine (Sect. 7.5)	201
Series R-L-C branch card (Sect. 1.21)	6
Sheath of "CABLE CONSTANTS" (Sect. 7.7.1)	251
Shell-type 3-phase transformers (Sect. 1.25)	12g
Shipley matrix reduction/inversion formula (Sect. 7.4, App. 4)	180
Short Course. See "Education".	
Siemens version of EMTP (Sect. 0.5a)	x-a
Signal selector, Type-61 TACS device (Sect. 8.5.5)	308
Signal sources of TACS; TACS sources (Sect. 8.5.4)	292

Silicon-carbide. See "Surge arrester"	
Simulator (EMTP-based)	x-j13
"SINGLE FLASH" option for Type-99 element (Sect. 1.28)	16f-1
Singularity tolerances. See:	
For network, Miscellaneous data (Sect. 1.0h, EPSILN, TOLMAT)	4f
ZnO surge arrester soln. (Sect. 1.32, end)	17h
Sinusoidal steady state. See "Phasor solution".	
Size of EMTP tables. See "variable dimensioning".	
Skin effect formulas of "LINE CONSTANTS" (Sect. 7.4, App. 2)	171
S.M. See "Synchronous machine".	
"SMOOTH" parameter of plotting (Sect. 1.10-A, Rule 8)	40a1
Smoothing of plotting by averaging. See "LIMIT ON PLOT OS..".	
SORTING, Sorting of data cards. See Interactive EMTP.	
Source cards of electric network (Sect. 1.6)	31
Source equivalents. See:	
"FAULT DATA USAGE" for constant-parameter (Sect. 1.0g13)	4e-11
List 27 (LSIZ27) for frequency-dependent (Sect. 0.6)	xiv
Source cards of TACS (Sect. 8.5.4)	292
Spark gap. See "Flashover gap".	
"SPARK" signal of TACS-controlled switch (Sect. 1.44)	30f
Special request cards at beginning of data case (Sect. 1.0)	3c
Spectral analysis. See "Fourier analysis."	
SPY. See "Interactive EMTP.....".	
\$SPYDATA. See "Interactive EMTP.....".	
SSR. See "Subsynchronous resonance".	
Staircase time-varying resistance (Type-97, Sect. 1.30)	16j
"START AGAIN" request to restart halted run (Sect. 1.0e15)	4c-4
Statistical overvoltage studies. See:	
Output variable specification (Sect. 1.8b)	38c
"STATISTICS" miscellaneous data (Sect. 1.1a)	5
"STATISTICS" output specification (Sect. 1.8b)	38c
"STATISTICS OUTPUT SALVAGE" request card (Sect. 1.0e7)	4b-5
"STATISTICS" switch (Sect. 1.4, Class 3a)	27a-1
"TABULATE ENERGIZATION RESULTS" request card (Sect. 1.0e6)	4b-4
"TIME OF DICE ROLL" request card (Sect. 1.0e12)	4c-1
"STATISTICS OUTPUT SALVAGE" to save results (Sect. 1.0e7)	4b-5
Steady-state phasor solution, explanation, KSSOUT (Sect. 1.0h)	4j
"STEP ZERO COUPLE" for subnetwork identification (Sect. 1.0g15)	4e-12
"\$STOP" to immediately terminate EMTP (Sect. 1.-D)	3b
Stratified earth model of "CABLE CONSTANTS" (Sect. 7.7)	267
Structure of EMTP data case (Sect. 1.)	1
Subsynchronous resonance (SSR) studies. See "Rotating machinery".	
Summer (zero-th order function) of TACS (Sect. 8.5.2)	288
Supercomputers. See "Cray-1 version".	
"SUPERIMPOSE" for multi-scale plots (Sect. 1.10B, Point 13)	43a
Supplemental variables of TACS (Sect. 8.5.5)	295
Supporting routines (Sect. 7.)	93a
Surge arrester modeling. See:	
Multi-phase, exponential ZnO model (Sect. 1.32)	17
Pseudo-nonlinear Type-99 resistor (Sect. 1.28)	16d
Multiphase non-linear resistance with flashover (Sect. 1.36)	21
Multiphase time-varying resistance (Sect. 1.35)	19
Surge function, Type-15 source component (Sect. 1.6)	33
Surge impedance Zs as line data (Sect. 1.26)	15
Switches and switched-element modeling:	
Introduction and overview (Sect. 1.4)	26
Ordinary switches (time-controlled, flashover, "STATISTICS", "SYSTEMATIC" ; Sect. 1.40)	26a

Diode and valve modeling, Type 11 (Sect. 1.43)	30c
Spark gap and TRIAC modeling, Type 12 (Sect. 1.44)	30f
Symbolic Debugger. See "Apollo.....".	
Symmetrical component quantities. See:	
"LINE CONSTANTS" theory (Sect. 7.4, Subsect. 5.)	154
Format for [R], [L] branch input (Sect. 1.24)	12b
Synchronous machine (S.M.) modeling:	
General recommendations (Sect. 1.62)	34d
Brandwajn (Type-59) modeling (Sect. 1.62)	34d
Former Type-50 (SCE) S.M. modeling (Sect. 1.62a, end)	35
Deletion of S.M. model (Sect. 1.62, end)	35a
Example using U.M. modeling (Sect. 1.63I)	361
Rules to convert from Type-50 or 59 to U.M. (Sect. 1.63J)	36m-3
"SYSTEMATIC" switches. See "STATISTICS"	
SYSTEM20 (DEC) version of EMTP. See "PDP-10 version".	
Table of Contents	i
"TABULATE ENERGIZATION RESULTS" to combine parts (Sect. 1.0e6)	4b-4
TACS (EMTP control system modeling capability). See:	
Rules for data assembly and operation (Sect. 8.)	274
Card to introduce TACS data (Sect. 1.20)	5e
"ABSOLUTE TACS DIMENSIONS" request card	4Bb-2
TACS-controlled switch. See "Valve", "Gap".	
TACS-controlled voltage or current source (Sect. 1.6, Type 60)	33
TACS-modulated voltage or current source (Sect. 1.6, Type 17)	32b
"TACS EMTP SOURCES" request for Type 1-10 sources (Sect. 1.0g2)	4e-1
"TACS HYBRID" request preceding TACS data (Sect. 1.20)	5e
"TACS STAND ALONE" request preceding TACS data (Sect. 1.20)	5e
"TACS WARN LIMIT" to redefine limit on warnings (Sect. 1.0g14)	4e-11
Tektronix. See "Plotting of EMTP results", "Proprietary software".	
Telefunken version of EMTP (Sect. 0.5a)	x-a
Terminal condition punching ("IPUN" of Sect. 1.0h)	4g
Thyristor modeling. See "Valve".	
Time usage to identify plot files. See "REPLOTT".	
"TIME OF DICE ROLL" for table-saving time (Sect. 1.0e12)	4c-1
Time-sequenced switch, Type-57 TACS device (Sect. 8.5.5)	305
"TIME STEP LOOP" request follows "START AGAIN" (Sect. 1.0e16)	4c-5
Time-step size (misc. data, DELTAT, Sect. 1.0h)	4f
Time-varying resistance elements. See:	
Type-97 staircase resistance (Sect. 1.30)	16j
Type-91 continuous resistance (Sect. 1.35)	19
"TMAX" termination time definition. See "Miscellaneous data".	
"TPPLOT" program for interactive EMTP plotting	86
Transfer function of control system. See "Function block".	
Transformation matrices of transmission line (Sect. 1.26)	13c
Transformer modeling. See:	
Saturable "TRANSFORMER" component (Sect. 1.25)	12d
"BCTAN" and "TRELEG" for multiphase linear models.	
Linear coupled R-L model (Sect. 1.24)	12
Ideal transformer (Sect. 1.60, Type 18)	32b
Supporting program to derive R-L model (Sect. 7.1)	93b
Refer also to nonlinear reactor modeling for saturation	
Transmission line modeling. See:	
Pi-circuit model (Sect. 1.23)	8
Continuously-transposed, distributed model (Sect. 1.26)	13
Untransposed, frequency-dependent model (Sect. 1.27)	16c1
Supporting programs (Sects. 7.0, 7.3 to 7.5)	93a
Transport delay, Type-53 TACS device (Sect. 8.5.5)	301

Transposition of lines, mathematics (Sect. 7.4, App. 5)	183
Trapped charge of line, how represented (Sect. 1.6, Rule 5)	33a
"TRASH" node of Type-16 source (Sect. 1.61, Rule 7)	34c
"TRELEG" routine for core-type transformers (Sect. 7.1a)	100a
TRIAC. See "Switches".	
"TSTART", the time simulation begins (Sect. 1.0h)	4f
Tsu-huei. See "Liu".	
"TYP-16" node of Type-16 source (Sect. 1.61, Rule 7)	34c
U.M. See "Universal Machine".	
U.M. interface with load flow (Sect. 1.63L)	36p
Ungrounded sources (Type-18 source component with Xformer)	32b
Univac version of EMTP (Sect. 0.5a)	x-a
Universal \$-cards (Sect. 1.-D)	3b
Universal machine (U.M.) modeling (Sect. 1.63)	36f
Untransposed, distributed transmission line model (Sect. 1.26)	13
"USE AB" option for Pi-circuits (Sect. 1.23, Rule 8)	11
"USE RL" option for Pi-circuits (Sect. 1.23, Rule 10)	11
User Groups to coordinate EMTP usage (Sect. 0.)	iv
"USER IDENTIFICATION" to mark CalComp plots (Sect. 1.0e1)	4b
User instruction. See "Education".	
User's Manual: former name for this work (Rule Book)	
"USER SUPPLIED SWITCH TIMES" request for statistics	4c-6
Valve (thyristor) switch component (Sect. 1.43)	
Van Dommelen, Prof. Daniel, K.U.L., Belgium. (also see "IBM")	iv-a
"VARDIM" program of variable-dimensioning (Sect. 0.6)	xiii
Variable dimensioning of EMTP tables (Sect. 0.6)	xiii
VAX version of EMTP (Sect. 0.5j)	x-j
Vector processors. See "Cray-1 version".	
Verbinnen, Mr. J., of LABORELEC (Belgium). See "SEL version".	
"\$VINTAGE" card to select data field width (Sect. 1.-D)	3b
Virtual memory management of computers (Sect. 0.)	iv-a1
Vladimir. See "Brandwajn".	
Voltage regulator modeling. See "Exciter modeling".	
Voltage source modeling. See "Source cards", "Rotating machinery".	
Warning messages. See "non-fatal informative messages".	
"WEIGHT" routine to derive weighting functions (Sect. 7.3)	104
\$WIDTH to change 80 vs. 132 cols. output (Sect. 1.-D)	3b
Windows. See "Apollo.....".	
"X-Y PLOT" with time as parameter (Sect. 1.10B, Point 15)	43e
"XFORMER" request for transfer to "XFORMER" (Sect. 1.0g)	4e
"XFORMER" routine for transformer [R], [L] (Sect. 7.1)	93b
"XOPT" units for inductance. See "Miscellaneous data cards".	
Z-block of TACS. See "Summer".	
Zero initial switch currents (warning of)	27d
"ZINC OXIDE" to change Newton iteration controls (Sect. 1.0g17)	4e-14
Zinc-oxide surge arrester modeling	
Branch card data input (Sect. 1.32)	17
Supporting routine "ARRDAT" to fit exponentials (Sect. 7.2b)	103h
Type-17 voltage-dependent current source (Sect. 1.6)	33